

The TALKING MACHINE WORLD

For the
makers &
sellers of
talking
machines

Published Each Month by Edward Lyman Bill, Inc., at 373 Fourth Ave., New York, July 15, 1919

*The instrument by which
the value of all musical
instruments is measured*

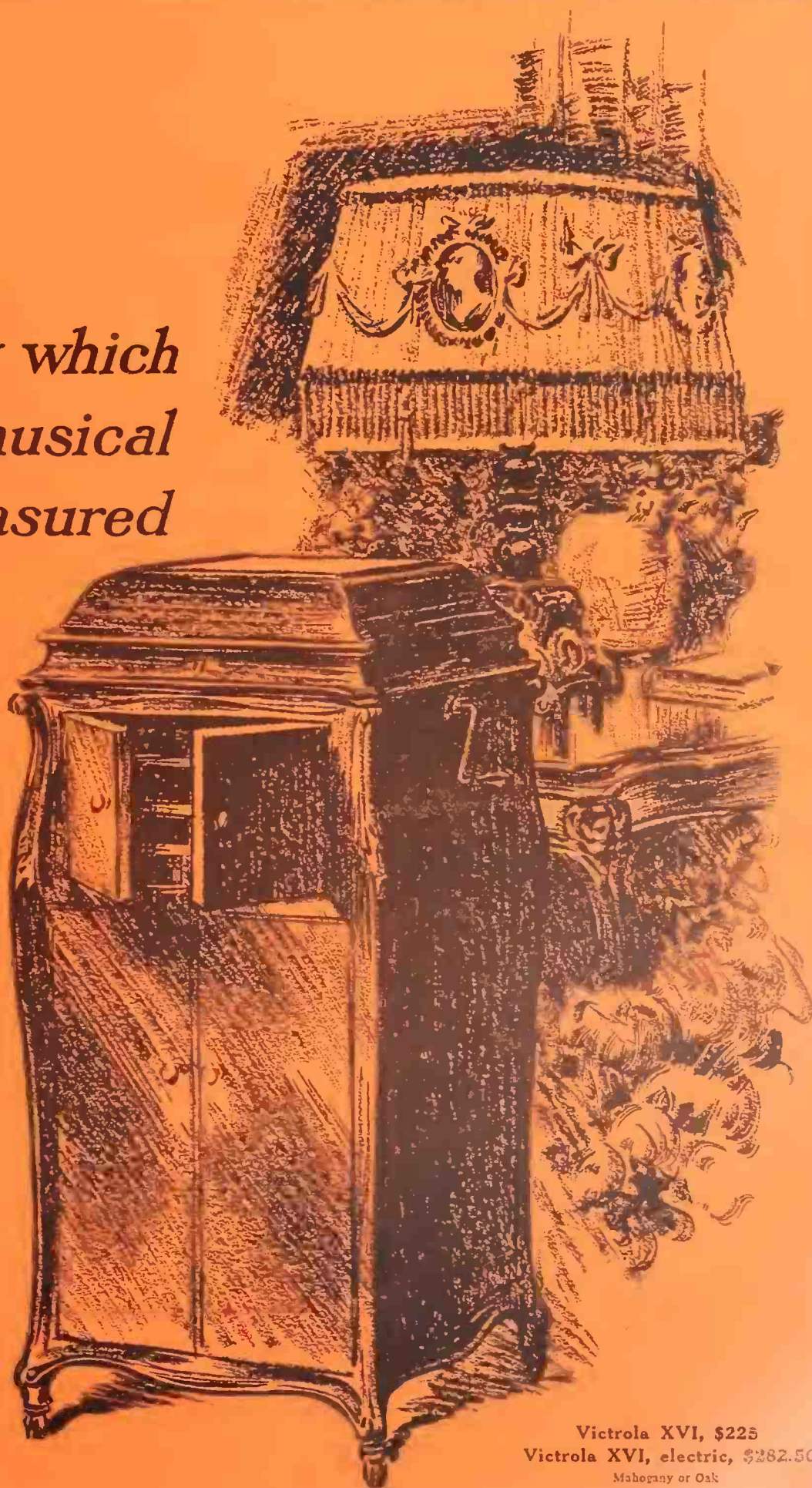

Victrola XVI, \$225
Victrola XVI, electric, \$282.50
Mahogany or Oak

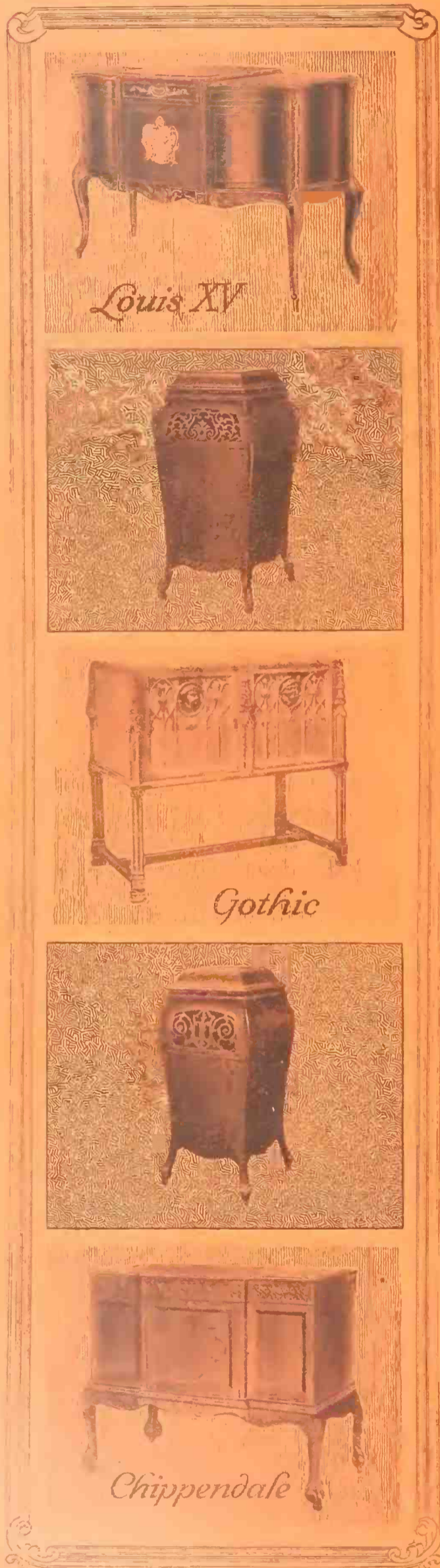

The Highest Class Talking Machine in the World

THE INSTRUMENT OF QUALITY
Sonora
CLEAR AS A BELL 

TO glance over the names of Sonora owners is like reading a selected list of the substantial people of the community—the bankers, well-to-do business and professional men, the socially prominent women—those who take pride in buying the best are Sonora owners.

It is not necessary for the Sonora dealers to cry "easy payments" in order to make sales. Most of the people who buy phonographs are prepared to pay cash when they find it advantageous and quality is an inducement, as it is in the Sonora. And it is interesting to know that the demand for Sonoras is so great that our factories are working to capacity and are being greatly enlarged.

Write for information if *you* would like to enjoy the advantages which the Sonora dealer has.

Here are shown just a few of the beautiful upright and period models which are now available. The price of the Sonora ranges from \$50 to \$1000 and every Sonora is of matchless value because of its magnificent tone and its many important and exclusive features of construction.

Sonora Phonograph Sales Company, Inc.

GEORGE E. BRIGHTSON, *President*

279 Broadway, Dept. Y, New York
Toronto: Ryrie Bldg.

Sonora is licensed and operates under BASIC PATENTS of the phonograph industry

The Talking Machine World

Vol. 15. No. 7

New York, July 15, 1919

Price Twenty-five Cents

TALKER AIDS AERIAL NAVIGATION

Recent Experiment in Washington Opens Up Another Use of the Talking Machine—Sound Transmitted to Airplane Over the City

One of the most unusual developments relating to the use of the talking machine in new fields is its adaptation as a guiding hand to aerial navigation. Experiments recently made public in Washington embody the talking machine in connection with the radio telephone and were demonstrated by the United States Signal Corps. By means of the device the voice of the talking machine was carried into the upper air regions and was audible to aviators flying over the city and announced to them that they were above the Capitol. The demonstration was conducted by Lieut. R. D. Duncan, Jr., of the Signal Corps, and is the result of long investigations by Major-General George O. Squier to make aerial navigation safer for the aviator.

In the experiment the motor attached to a Victrola was started and the wireless transmitter adjusted to carry the vibrations to the desired distance. The aviator, according to a prearranged schedule, sailed over the city and his receiving set picked up the words "Washington Beacon, No. 1," sent out into space by the machine below him. E. F. Droop & Sons, well-known music dealers of Washington, furnished the machine used in the experiment.

TALKING MACHINE AN AID TO ART

Mrs. Ethel Brasel, Manager Sherman-Clay Victrola Department, Shows Value of Talking Machine in Education of Children

Mrs. Ethel Brasel, manager of the Victrola department of Sherman-Clay & Co., Spokane, Wash., was recently quoted in the newspapers of that city on the subject of the value of the talking machine in the schools as an aid to the appreciation of art. The public school officials in that city have expressed themselves in favor of this method and are using it with success Mrs. Brasel said:

"The child whose home contains a talking machine is presumably a child who has a keener appreciation than the child who has not this advantage. Not one American child in a hundred, as the taste of the people now stands, is really musical from birth. We find only a small minority of children gifted with executive or creative talent in music, but every normal child has the capacity to enjoy music, and they should become acquainted with the good classics when the opportunity under proper guidance is available.

"The children should be taught to listen intelligently to music in the home through good records of world-famed artists. The talking machine presents the most interesting, most efficient and most attractive of all means for producing musical feeling and knowledge of standard classics.

"The child mind presents a field for promotive work in the love and appreciation of the noblest of all arts. We come to see more and more that music is something to be taught through constant presentation, and that a taste for good music is the most important element in the development of the strongest character and mind."

SHIP RECORDS BY AIRPLANE

At the inauguration of the first aerial transportation service in Boston the Grafonola Co. of New England sent a shipment of records from Franklin Field to Swampscott in one of the planes operated by the North Shore Aerial Transportation Co.

HOLD ANNUAL OUTING NEXT MONTH

Plans Perfected for "Big Time" of Talking Machine Men, Inc., at Rye Beach August 13—Sports and Eats Chief Features on Program

The annual outing of The Talking Machine Men, Inc., the organization composed of talking machine dealers of New York, New Jersey and Connecticut, will be held at Rye Beach, Wednesday, August 13. The trip to the beach will be made in buses and private cars, and the members will be notified of the time and place of the departure of the buses.

J. J. Davin, the only "active associate member" of the organization, with a committee, has made arrangements for the affair and it is probably the best-planned outing in the history of the association.

Aside from the elaborate dinner that will be served in the evening, a light luncheon will welcome the guests upon their arrival. Arrangements for water sports, including row boats, a



J. J. Davin

ball game and field sports, are programmed, and in the evening the members and their guests will be entertained at a theatre party. The tickets will cost \$4.00 and will include the bus ride, luncheon, dinner, theatre and an opportunity to take part in the activities of the day. The members will return to the city at 10 o'clock in the evening.

The various affairs of the program have been placed in the hands of individual committees. This arrangement, together with a perforated card divided in a manner entitling the holder to luncheon, dinner and theatre, etc., will, it is thought, make for efficiency in carrying out the day's program. Much of the credit for this year's affair, as usual, must be given to Mr. Davin, who, for the past few weeks, has placed much of his time at the disposal of the organization.

Following are the names of those in charge of the various activities: Transportation from New York to Rye Beach and return, Cass Riddle; luncheon and dinner, E. Leins and F. H. Ponty; bathing accommodations, John Hunt and Al Adelstein; water sports, row boats, etc., Mr. Saunders; baseball arrangements and field sports, Messrs. Spillane and Thaw; dancing arrangements, Mr. Bouregard; publicity, finance and printing, A. Galuchie and J. J. Davin; pennants and buttons, Sol Lazarus; reception committee, Messrs. McCoy, Stiles, Clinton and R. Tusting, Sr.

Pennants will be especially designed with the insignia of the association, and buttons to carry the name of each member will be provided.

"JAZZ" MAY START ANOTHER WAR!

Nations Vying With Each Other for Credit of Originating the Jazz Band Idea—Paris Daily Has Story Claiming France Has the Honor

Well! It looks as if France and the United States may have a little war all their own over the origin of the jazz band! There has been much speculation in the press of late in this country as to just where this tantalizing melody really started and while each one tried his hand at giving the only true history of its origin, placing the birthplace anywhere from the sunny South to the frozen North, everyone agreed that it was somewhere in this country. But now comes word in the shape of a cablegram to the New York Times stating that the well-known Paris daily, "Le Matin," declares the credit for inventing the jazz band belongs to France. It is not clear whether this statement is a part of the anti-American propaganda just now so prevalent in the French press, but it is made with evident feeling of conviction. The report goes on to say: According to this report the jazz idea originated in Paris in the time of the Directoire, when the people used to go with great frequency to ball concerts. The report goes on to say:

"In those days as well as now people did not know what to do to amuse themselves; so they made a noise. Those who had great taste for noise went to the concerts of the Cat Orchestra. There were twenty cats with their heads in a row on the keyboard of a harpsichord. The performers by striking the keys worked a device which pulled the cats' tails, causing a caterwauling which gradually took on as much volume of sound as the jazz band and was fully as musical and entertaining. This so-called American invention is only a recurrence." And there you are!

TALKING MACHINE EXPORTS DECLINE

Exports, Including Records, for Ten Months, Ending April 30, 1919, Total \$3,572,154

WASHINGTON, D. C., July 1.—In the summary of exports and imports of the commerce of the United States for the month of April, 1919 (the latest period for which it has been compiled), which has just been issued, the following figures on talking machines and records are presented:

The dutiable imports of talking machines and parts during April, 1919, amounted in value to \$30,402, as compared with \$25,039 worth which were imported during the same month of 1918. The ten months' total ending April, 1919, showed importations valued at \$233,128, as compared with \$284,724 worth of talking machines and parts imported during the same period of 1918.

Talking machines to the number of 3,743, valued at \$141,057, were exported in April, 1919, as compared with 8,558 talking machines, valued at \$254,022, sent abroad in the same period of 1918. The ten months' total showed that we exported 41,184 talking machines, valued at \$1,244,583, as against 78,293 talking machines, valued at \$2,168,752, in 1918, and 62,606 talking machines, valued at \$1,612,957, in 1917.

The total exports of records and supplies for April, 1919, were valued at \$266,730, as compared with \$177,973 in April, 1918. For the ten months ending April, 1919, records and accessories were exported, valued at \$2,327,571, as compared with \$1,653,390, in 1918, and \$1,257,530, in 1917.

The National Vitaphone Sales Corp. has been incorporated under the laws of New Jersey to manufacture talking machines, records, etc. The capital is \$125,000.

Real Salesmanship in Retail Talking Machine Business Brings Its Rewards :: :: By C. B. Shepherd

The statement has been made that during the past few years at least there has been no real need for advanced salesmanship in the retail talking machine business. That is, salesmanship of the higher sort which is absolutely essential to success in other lines of endeavor, including the closely allied piano business. The excuse has been that, in the first place, the manufacturers' advertising brought the business for both machines and records right into the store of the dealer, who found the customer already sold before he had entered the store and required of the dealer only that he display and test a machine offered at a certain price or find in his stockroom records bearing certain specified titles or numbers. Secondly, it has been claimed, and with some degree of truth, that the market has for years been oversold in the popular makes of talking machines and records—that with the demand in excess of the producing ability of the factories the dealer had little else to do but fill the orders that came to him without any great personal effort.

Notwithstanding arguments to the effect that retailers are doing business without great effort and making some money at it, despite the oversold condition of the market, I, for one, maintain that genuinely efficient salesmanship is as essential to successful talking machine selling as to any other line of business. In every State and in every city or town where there are several competing dealers handling talkers the traveler will find one who believes in salesmanship and insists upon his staff using proper selling tactics. Without exception it will be found that that particular dealer is getting more than his pro rata share of the local business—enough more to make his salesmanship pay substantial dividends. The extra effort may mean only the sale of a machine here or a few records there occasionally, as representing business that would not have come to him naturally, but that little extra sale here and there makes a most substantial total during the year. It marks the difference between making an easy living and making money and leaves with the buyer the impression that he is doing business with a wide-awake store—a store that appreciates his patronage and wants more of it.

My experience indicates that the great lack of salesmanship that one runs against in the trade is due chiefly to the indifference of the dealers

themselves who have found that sufficient trade comes to their doors to provide them with a good living. With this type of competition to meet it is little wonder that the progressive retailers, the fellows who go after business and sell their goods, stand out from the rest so sharply.

Every sale made to-day, every new customer impressed with the desire to do business with you, means just so much less left for future accomplishment. And the customer likes to be sold, likes to be made to feel that he is welcome in the store and is not breaking into a siesta. You, Mr. Dealer, like to receive attention yourself when you enter the haberdasher's or the

of selling is to know your goods, because you cannot talk convincingly regarding the qualities of a product with which you are not familiar. Despite this there are to-day salesmen who cannot intelligently explain the difference between various types of machines, much less give any details regarding motor or sound-box construction.

People are asking for just such information to-day. The manufacturers are calling attention to special mechanical features in their advertising and the prospective purchasers are asking questions. They want to know just how one machine differs from another and it will not be long before the salesman who cannot explain that difference intelligently and convincingly will be out of luck. In the matter of records, for instance, the real salesman will not only be able to describe the difference between the types intelligently, but, regardless of whether he is selling lateral or vertical-cut records, will be able to tell just why the system used in making the particular record he handles is the best. The woods are full of good and logical arguments on both sides. Expert salesmanship means realizing on opportunity, an opportunity that many of the members of the trade who can be recognized readily have realized. Soon there may be changed conditions and selling will become a necessity.

*Expert Salesmanship
Means Realizing on
Opportunity—Those
Possessing It Win*

cigar store, so why not credit your customer with the same human characteristic?

Giving the customer what he asks for, taking his money and letting him walk out without any comment beyond the brief "anything else to-day?" is neither salesmanship nor even service. By appealing to the customer who has once been so treated the live retailer with salesmanship and service back of him and a smile is taking away trade from the sleepy one and building up more than his pro rata share of trade. It's being done right now—look for yourselves.

If there is anything more pitiable than lack of salesmanship it is the performance of the salesman who knows he should try to sell but doesn't know how to go about it. This condition is squarely up to the dealer who employs him, but has not taken the trouble to train him. One of the fundamental principles

C. P. MACK ON COLUMBIA STAFF

Becomes Member of Los Angeles Traveling Staff—Will Cover Arizona Territory

LOS ANGELES, CAL., July 3.—William F. Stidham, manager of the wholesale branch of the Columbia Co. in this city, has appointed Charles P. Mack as a member of the traveling staff. Mr. Mack, who, at the time of the signing of the armistice, resigned his commission of second lieutenant in the Field Artillery, returned to the Bartlett Music Co., of Los Angeles, with which he had previously been associated for a number of years. Mr. Mack's new appointment will take him to the Arizona territory, and his intimate familiarity with the problems confronting the dealers, together with his long experience in retail salesmanship, will undoubtedly enable him to give his clientele practical cooperation and service.

THE WAR IS OVER

But a new REVOLUTION will take place

WHERE ?

At the
New York Album & Card Co.

WHY ?

A record album surpassing in quality any book now manufactured will be placed on the market at an attractively low price.

IT

will pay you to

AWAIT

our August issue

BEFORE

Placing your fall business.

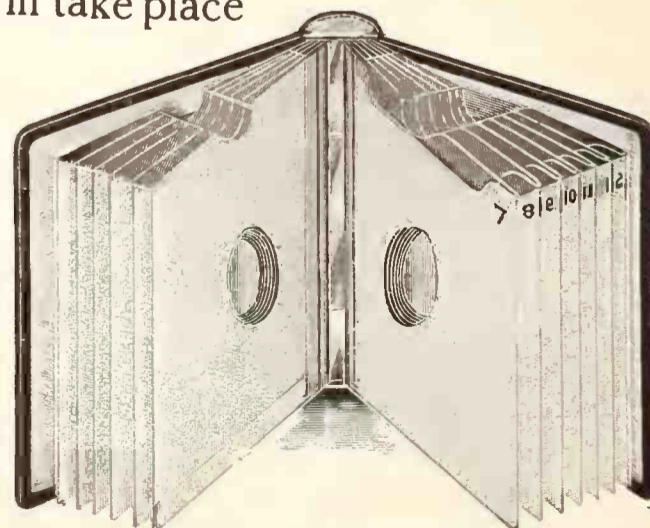
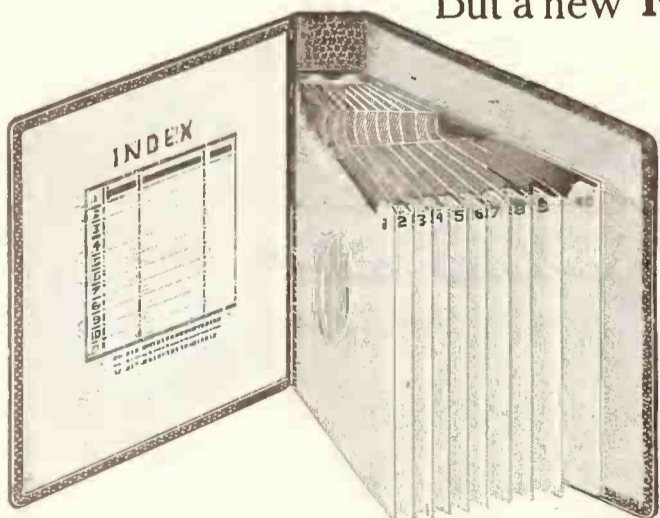

New York Album & Card Co., Inc.

Factory and Executive Offices: 23-25 Lispenard St., New York



Chicago, Ill.: CULLEN, MARSH & CO.
21 East Van Buren St., Middle West Rep.

San Francisco, Cal.: WALTER S. GRAY
Chronicle Bldg., Pacific Coast Rep.

Victrola VI, \$35
Mahogany or oak

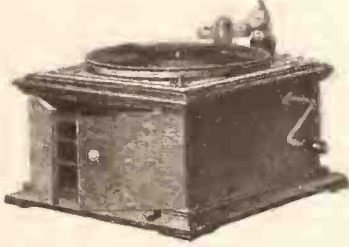

Victrola IX, \$60
Mahogany or oak



Victrola XI, \$115
Mahogany or oak



Victor Supremacy

Victor supremacy points the way to success for every music retailer.

It marks the "path of least resistance."

Victor Talking Machine Co.
Camden, N. J., U. S. A.

"Victrola" is the Registered Trade-mark of the Victor Talking Machine Company designating the products of this Company only.

Warning: The use of the word Victrola upon or in the promotion or sale of any other Talking Machine or Phonograph products is misleading and illegal.

Important Notice. Victor Records and Victor Machines are scientifically co-ordinated and synchronized in the processes of manufacture, and should be used together to secure a perfect reproduction.

Victrola XVI, \$225
Victrola XVI, electric, \$282.50
Mahogany or oak



Victor Wholesalers

- | | | |
|---|---|---|
| Albany, N. Y.... Gately-Haire Co., Inc. | Elmira, N. Y..... Elmira Arms Co. | Omaha, Nebr..... A. Hospe Co. |
| Atlanta, Ga..... Elyea Company | El Paso, Tex..... W. G. Walz Co. | Mickel Bros. Co. |
| Phillips & Crew Piano Co. | Honolulu, T. H.... Bergstrom Music Co., Ltd. | Peoria, Ill..... Putnam-Page Co., Inc. |
| Baltimore, Md.... Cohen & Hughes. | Houston, Tex.... Thos. Goggan & Bro. | Philadelphia, Pa.. Louis Buehn Co., Inc. |
| E. F. Droop & Sons Co. | The Talking Machine Co., of | C. J. Heppe & Son. |
| H. R. Eisenbrandt Sons, Inc. | Texas. | The George D. Ornstein Co. |
| Bangor, Me..... Andrews Music House Co. | Indianapolis, Ind.. Stewart Talking Machine Co. | Penn Phonograph Co., Inc. |
| Birmingham, Ala. Talking Machine Co. | Jacksonville, Fla.. Florida Talking Machine Co. | The Talking Machine Co. |
| Boston, Mass.... Oliver Ditson Co. | Kansas City, Mo.. J. W. Jenkins Sons Music Co. | H. A. Weymann & Son, Inc. |
| The Eastern Talking Machine Co. | Schmelzer Arms Co. | Pittsburgh, Pa.... W. F. Frederick Piano Co. |
| The M. Steinert & Sons Co. | Lincoln, Nebr.... Ross P. Curtice Co. | C. C. Mellor Co., Ltd. |
| Brooklyn, N. Y... American Talking Mch. Co. | Los Angeles, Cal.. Sherman, Clay & Co. | Standard Talking Machine Co. |
| G. T. Williams. | Memphis, Tenn.... O. K. Houck Piano Co. | Portland, Me..... Cressey & Allen, Inc. |
| Buffalo, N. Y.... W. D. & C. N. Andrews. | Milwaukee, Wis... Badger Talking Machine Co. | Portland, Ore.... Sherman, Clay & Co. |
| Buffalo Talking Machine Co., Inc. | Minneapolis, Minn. Beckwith, O'Neill Co. | Providence, R. I... J. Samuels & Bro., Inc. |
| Burlington, Vt.... American Phonograph Co. | Mobile, Ala..... Wm. H. Reynolds. | Richmond, Va.... The Corley Co., Inc. |
| Butte, Mont..... Orton Bros. | Newark, N. J.... Price Talking Machine Co. | W. D. Moses & Co. |
| Chicago, Ill..... Lyon & Healy. | New Haven, Conn. The Horton-Gallo-Creamer Co. | Rochester, N. Y... E. J. Chapman. |
| The Rudolph Wurlitzer Co. | New Orleans, La... Philip Werlein, Ltd. | The Talking Machine Co. |
| Chicago Talking Machine Co. | New York, N. Y... Blackman Talking Mach. Co. | Salt Lake City, U. Consolidated Music Co. |
| Cincinnati, O.... The Rudolph Wurlitzer Co. | Emanuel Blout. | The John Elliott Clark Co. |
| Cleveland, O..... The W. H. Buescher & Sons Co. | C. Bruno & Son, Inc. | San Antonio, Tex. Thos. Goggan & Bros. |
| The Collister & Sayle Co. | Charles H. Ditson & Co. | San Francisco, Cal. Sherman, Clay & Co. |
| The Eclipse Musical Co. | Knickerbocker Talking Machine Co., Inc. | Seattle, Wash..... Sherman, Clay & Co. |
| Columbus, O..... The Perry B. Whitsit Co. | Landay Bros., Inc. | Sioux Falls, S. D.. Talking Machine Exchange. |
| Dallas, Tex..... Sanger Bros. | New York Talking Mach. Co. | Spokane, Wash.... Sherman, Clay & Co. |
| Denver, Colo.... The Knight-Campbell Music Co. | Ormes, Inc. | St. Louis, Me..... Koerber-Brenner Music Co. |
| Des Moines, Ia... Mickel Bros. Co. | Silas E. Pearsall Co. | St. Paul, Minn.... W. J. Dyer & Bro. |
| Detroit, Mich.... Grinnell Bros. | | Syracuse, N. Y.... W. D. Andrews Co. |
| | | Toledo, O..... The Toledo Talking Machine Co. |
| | | Washington, D. C. Cohen & Hughes. |
| | | E. F. Droop & Sons Co. |
| | | Robt. C. Rogers Co. |

ALL RECORD CUSTOMERS ARE ALBUM CUSTOMERS



MAKING THEIR SELECTION

A Place for Every Record and Every Record in its Place

Albums are an **Indispensable Requisite** in the talking machine business and wherever records are sold. Practical and handy. Save time and records. A **profitable adjunct** to the business.

We manufacture disc Record Albums to fit cabinets of all sizes and styles. With the indexes they are a complete system for filing all disc records.

We have unexcelled manufacturing facilities, and considering quality our prices are the lowest. Write us, giving quantity you may desire, and we will quote prices.

OUR ALBUMS ARE MADE TO CONTAIN VICTOR, COLUMBIA, EDISON, PATHE AND ALL OTHER DISC RECORDS

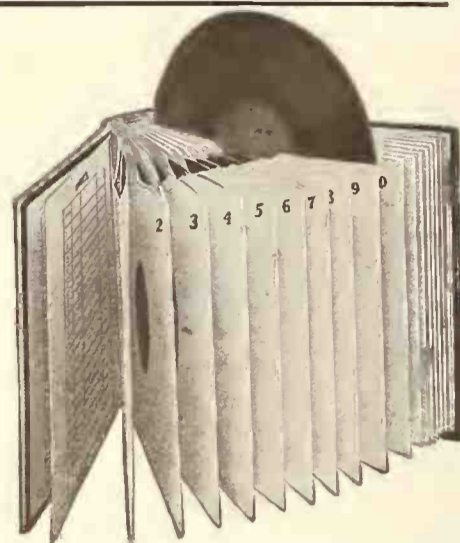

THE PERFECT PLAN

NATIONAL PUBLISHING CO., 239 S. American St., PHILADELPHIA, PA.

DEALERS ENLARGING THEIR STORES

Big Army of Dealers Making Ready for Marked Increase of Business Expected in the Fall

The New York Talking Machine Co. reports that many of its clients handling Victor machines are at this time enlarging their shops in order to meet the increased business which is expected in the fall. That this is the time to make improvements in order to accommodate the future business is unquestionable. Among those companies which have bettered their exhibiting and demonstrating departments are C. A. Hansenn & Bro., 4711 Fifth avenue, Brooklyn, who have double-sized their store by buying the premises adjoining them. They have also renovated the shop and installed new fixtures.

The Fulkerson Music House, Carbondale, Pa., have recently installed a battery of four new booths in order to give their customers more exclusive service in the future. W. J. Killea, of Albany, N. Y., has moved from 74 Pearl street to number 35 Pearl street, in order to secure larger quarters and also to secure a better position. He has installed six new booths and has arranged a very attractive appearance at his new location. In New London, Conn., D. S. Marsh has installed six new booths in order to meet the increased business which has already crowded his present quarters, as well as to take care of the increased business which he expects in the fall.

MERCHANTS AFTER NEW BUSINESS

Taking advantage of the building boom going on in Burbank, Cal., merchants of Glendale are arranging to establish branch stores there. The Glendale Phonograph & Piano Co., Glendale, Cal., has leased a building in Burbank and will open under the management of Salamncia Bros.

A MESSAGE IN THE VICTOR CODE

Talking Machine Men, Inc., Send a Message to Their Membership That Requires a Victor Numerical Record Catalog to Decode

The Talking Machine Men, Inc., have just sent an important message in code to the membership of the organization. The message is in the nature of a Tri-State Union Recordgram, and instead of the ABC, Western Union or other codes of commerce the recipient, if he is in the talking machine business, needs only the Victor catalog code. The message of several paragraphs is made up entirely of record numbers.

For the benefit of those who have neither the time nor the inclination to grab a catalog and dig out the solution for themselves there is provided a translation. From the opening salutation 18438-16320, namely, "Tom, Dick, Harry and Jack"—"Greeting," to the signature, 35528, namely, "Very Good Eddie," it is a clever piece of work.

EDISON SHOP IN SPRINGFIELD

Marie Morrissey Appears in Person at the Formal Opening of New Edison Store

A new Edison Shop was opened in Springfield, Mass., on June 20, by B. L. Conchar & Co. at 488 Main street. This concern began business in that city three years ago when it opened the first Edison store in Springfield at 204 Washington street. Since that time the business has grown rapidly and new quarters were needed. The new location has been remodeled and sound-proof booths have been added and the rear of the store fitted up as a concert hall for recitals. At the formal opening Miss Marie Morrissey, the well-known Edison artist, and Jacques Glockman, cellist, rendered a pleasing program.

RETURNS FROM SUCCESSFUL TRIP

Geo. W. Hopkins Visited Leading Cities West and South and Transacted Much Important Business in the Interest of Columbia Co.

George W. Hopkins, general sales manager of the Columbia Graphophone Co., New York, returned recently from a Western and Southern trip which included a visit to the Columbia branches in St. Louis, Dallas, New Orleans and Cincinnati. At St. Louis Mr. Hopkins introduced to the Columbia organization in that city and to the dealers John McKenna, who has been appointed manager of this branch. A. W. Roos, heretofore acting manager of the St. Louis branch, has assumed the duties and functions attached to the position of assistant manager.

From St. Louis Mr. Hopkins went to Dallas, where he attended a very successful Columbia dealers' meeting given under the auspices of Fred R. Erisman, manager of this branch. At New Orleans a similar meeting was held, and Wm. F. Standke, manager of the New Orleans branch, furnished the dealers with a practical and valuable program. At Cincinnati F. F. Dawson, manager, and Norman B. Smith, assistant manager, also arranged a dealers' meeting which was attended by Mr. Hopkins. Mr. Smith conducted the incidental details of this meeting, and the dealers were enthusiastic regarding the practical topics discussed.

PARLEPHONE PLANT LOCATED

The Parlephone Co., St. Joseph, Mo., which recently leased the building on Fourth street in that city, is now making an addition to its quarters. E. E. Trower heads the new concern, which will use the St. Joseph plant for the manufacture of cabinets for the machines. The other parts will be made elsewhere and shipped to this plant to be assembled.

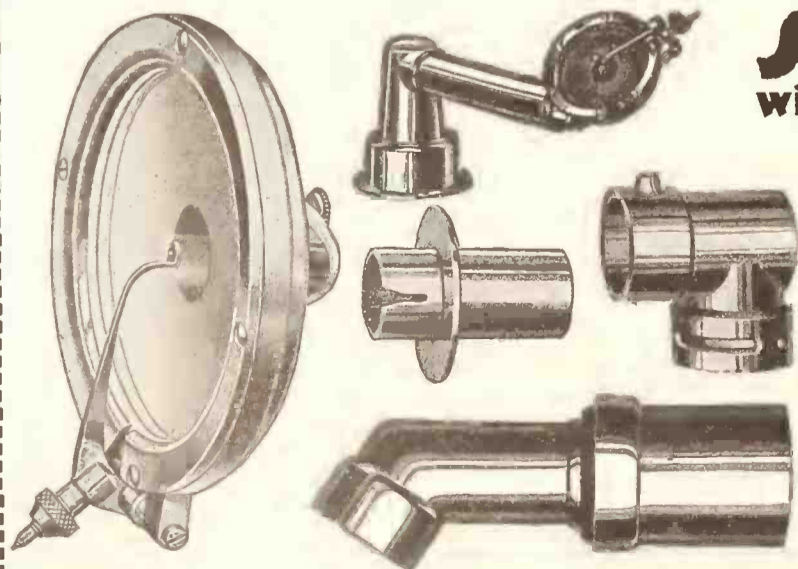

Superior Die Castings

will Cut Your Costs and Increase Your Sales

Tonearm and Reprodncer Parts, Attachments, Turntable Hubs, Motor Governor Discs, Knobs, Piano Player Parts—accurately cast in Aluminum, White Brass, White Metal Alloys or Zelco Metal—ready for nickel or gold plating. We employ a large force of die makers especially skilled in this class of work and operate a large battery of die casting machines of our own design and construction with a capacity of 50,000 to 100,000 castings per day.

Write for Samples of Work we are doing in this line



Send us your Specifications or Models for quotations

Barnhart Brothers & Spindler
Monroe and Throop Streets Chicago, Illinois



Victrola IV, \$25
Oak



Victrola VI, \$35
Mahogany or oak

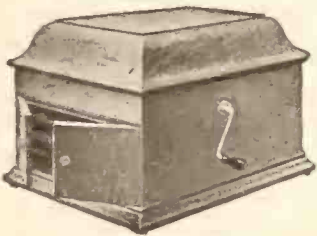

Victrola VIII, \$50
Oak

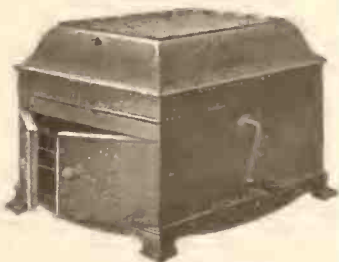

Victrola IX, \$60
Mahogany or oak

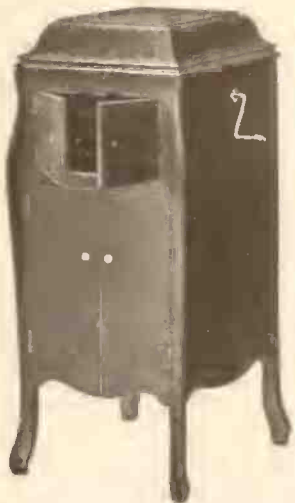

Victrola X, \$90
Mahogany or oak



Victrola XI, \$115
Mahogany or oak

Victor Supremacy

The supremacy of the Victrola is as evident in the prosperity of Victor retailers as in the great musical accomplishments of the instrument itself.

Victor supremacy means retailer success.

Victor Talking Machine Co.

Camden, N. J., U. S. A.



Victrola XIV, \$175
Mahogany or oak

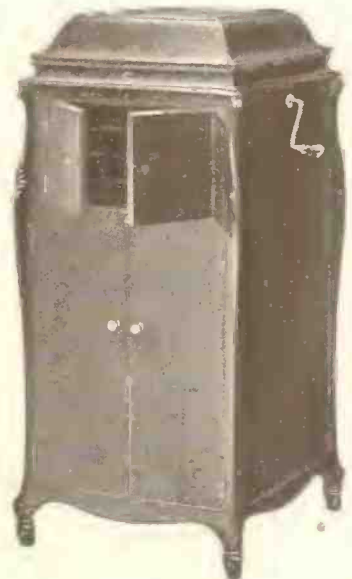

Victrola XVI, \$225
Victrola XVI, electric, \$282.50
Mahogany or oak



Victrola XVII, \$275
Victrola XVII, electric, \$332.50
Mahogany or oak

"Victrola" is the Registered Trade-mark of the Victor Talking Machine Company designating the products of this Company only.

Warning: The use of the word Victrola upon or in the promotion or sale of any other Talking Machine or Phonograph products is misleading and illegal

Important Notice. Victor Records and Victor Machines are scientifically co-ordinated and synchronized in the processes of manufacture, and should be used together to secure a perfect reproduction.



"HIS MASTER'S VOICE"
REG. U.S. PAT. OFF.

The **TALKING**
For the makers & sellers of talking machines
MACHINE
WORLD

PUBLISHED BY EDWARD LYMAN BILL, Inc.

President and Treasurer, C. L. Bill, 373 Fourth Ave., New York; Vice-President, J. B. Spillane, 373 Fourth Ave., New York; Second Vice-President, Raymond Bill, 373 Fourth Ave., New York; Assistant Treasurer, Wm. A. Low.

J. B. SPILLANE, Editor

RAYMOND BILL, B. B. WILSON, Associate Editors

Trade Representatives: WILSON D. BUSH, C. CHACE, EDWARD LYMAN BILL, V. D. WALSH, E. B. MUNCH, CHAS. A. LEONARD, L. E. BOWERS, A. J. NICKLIN

Boston: JOHN H. WILSON, 324 Washington Street

Chicago Office: EDWARD VAN HARLINGEN and Associates, Republic Building, 209 South State Street. Telephone, Wabash 5774

London, Eng., Office: 2 Gresham Buildings, Basinghall St. W. LIONEL STURDY, Mgr.
 The Talking Machine World has regular correspondents located in all of the principal cities throughout America.

Published the 15th of every month at 373 Fourth Ave., New York.

SUBSCRIPTION (including postage): United States, Mexico, \$2.00 per Year; Canada, \$3.00; all other countries, \$4.00. Single copies, 25 cents.

ADVERTISEMENTS, \$4.50 per inch, single column, per insertion. On quarterly or yearly contracts a special discount is allowed. Advertising pages, \$125.00.

REMITTANCES should be made payable to Edward Lyman Bill, Inc., by check or Post Office Money Order.

NOTICE TO ADVERTISERS.—Advertising copy should reach this office before the first of each month. By following this rule clients will greatly facilitate work at the publication headquarters.

Long Distance Telephones—Numbers 5982-5983 Madison Sq.
 Cable Address: "Elbill," New York.

NEW YORK, JULY 15, 1919

THE past month, being recognized as the convention season, has seen the holding of several conventions in the talking machine trade, bringing together various prominent trade interests. It is true that the industry has not yet advanced to the point, for some reason or other, where it can boast of a national association taking in representatives of all interests, but, in the absence of such an all-embracing body, it seems well that those wholesalers and retailers affiliated directly or indirectly with one or the other of the large manufacturing companies come together for a discussion of the business problems, and for the mapping out of campaigns for future business.

The conventions this year have been particularly important, inasmuch as the war has ended, and there have cropped up in its wake many questions of business character that require elucidation. The subject of production has, of course, been a dominating one for the trade throughout the country, which has been underfed in the matter of stock for many months past, and it is particularly timely now that the hunger for goods has passed the passive stage. For the various factories to get back on even a pre-war basis has been a severe task, but as they have approached that welcome goal they find that although production has lagged during the war period the demand has increased in almost direct ratio. In fact, pre-war standards of production and of marketing are not adequate to present-day needs.

Then, too, there are changes in sales policies that must be considered. It is just possible that a seller's market may not reign supreme in the talking machine field, and it is the duty of far-seeing business men to provide against any such contingency while laying plans in advance of any necessity for their carrying out.

These questions have been threshed out at several conventions more or less to the satisfaction of those directly interested. That the industry is not standing still in the matter of style development while endeavoring to catch up on production has been evidenced by the many new creations in machines that have been offered in and outside of the conventions. The industry is going ahead in more ways than one. It is broadening out, and does not require attendance at the convention to make known that fact.

The get-together spirit—the willingness to meet and discuss questions that are best solved through an interchange of opinion rather than by the sole efforts of the individual himself—is the spirit that should be encouraged, for it works directly to the advantage of the industry as a whole.

AFTER many months of effort on the part of various interested parties to persuade the talking machine interests to become affiliated with the piano and other divisions of the industry in support of the Music Industries Chamber of Commerce, thus having every branch of the music industry represented in that organization and making it all-embracing, it appears that the desired result has been obtained in some small measure at least through the recent affiliation of the Talking Machine Men, Inc., of New York, with the National Association of Music Merchants. The national organization is a divisional member of the Chamber of Commerce, and therefore the Talking Machine Men, Inc., through its membership in the Association becomes automatically affiliated with the Chamber of Commerce.

It must be admitted that the attitude of the talking machine men as a rule has not been favorable to the Chamber of Commerce plan, as a result of some idea, whether based on fact or not, that the piano men were inclined to gain their own ends in tax matters and other questions at the expense of the talking machine trade. With the urgent necessity for self-preservation removed with the ending of the war, it may be that a cordial relationship will be established between talking machine and piano interests in the nature of their business as members of the same music industry, with their business connections through retail distributing channels, and with the same advantages to be gained by a more general advancement of the cause of music.

The change in the constitution of the National Association of Piano Merchants resulted in the changing of the name of that organization to the "National Association of Music Merchants." and the opening of membership rights to all retailers in musical instruments clears the way for various talking machine organizations to become affiliated with that body, and through it with the Chamber of Commerce, without being under obligation to form their own distinct trade division.

THE members of the music industry have come to a full realization of a new attitude of the American public toward music and of the fact that the United States already is or is fast becoming the musical nation of the world. It is gratifying to find, however, that this new attitude of the public towards music and the influences that have brought about that new attitude have become recognized outside of the industry, proof of which is offered in a leading article in *Printers' Ink* recently by Frank H. Williams, in which the writer points out most convincingly that the advertising of the music industry during the past few years is the advertising that has most deeply affected American national life.

A number of factors joined together have succeeded in producing this recognized result, but without question the two leading factors have been the advertising of the talking machine manufacturers and of the player-piano manufacturers. Having developed their instruments to a point where they were not to be considered as novelties, these manufacturers concentrated their advertising arguments on music, and they kept pounding away on the fact that music was an essential part of the home life; that it was absolutely necessary to human happiness, and could be obtained readily, and in desired quantities and quality, through the medium of talking machines, player-pianos and other instruments.

Coupled with this advertising has been the propaganda for music carried on by various interests in and out of the trade, but principally by the National Bureau for the Advancement of Music, which, through the encouragement of community singing, music-memory contests, co-operative advertising, and by other means, has served to co-ordinate and expand the various forces working for music to the end that the public has had music offered at every turn.

The straight advertising has been the primary cause of this new attitude toward music and things musical. The public was informed not of the details of the instrument, for it was assumed that it knew something of the product, but the attack was made along the lines of giving music lovers, and particularly those who had not given the matter thought, some idea of the opportunities of education and entertainment offered by the music obtainable through various types of instruments. Some years ago there was much criticism of "canned" music. It was a standing joke in certain quarters. Now this same "canned" music is taken seriously and its nickname has passed, for there is no question but that music produced by automatic means, either through the medium of the

talking machine or the player-piano—the production of which requires little or no technical training and very little labor—has proven a dominating factor in making America musical.

The war unquestionably has helped in this work, for wherever soldiers and sailors congregated in any number they had the opportunity of listening to music and plenty of it, but without the war the advertising of the industry itself has brought results that have now been acknowledged by those who keep their fingers on the pulse of advertising and its effect. It is hoped that with the ice once broken this recognition will become more general, for music advertising deserves it.

THE announcement appearing elsewhere in The World this month of the return from France of E. A. Widmann, president of the Pathé Frères Phonograph Co., with contracts for producing in this country phonographs and records approximating in value \$100,000,000 annually, has a deep significance for members of the trade in general, whether or not they are allied with the Pathé interests, for it means a new and important step in the development of American talking machine and phonograph production.

The Pathé products referred to were formerly manufactured in France, and the transferring of the contracts for their manufacture to the United States and the placing upon the Pathé interests in this country the responsibility of taking care of all the requirements of the Western Hemisphere, together with those of England and her colonies, form one of the most important moves made in many years.

While these contracts will, of course, revert most directly to the benefit of the Pathé interests themselves, they tend to lend added importance to the talking machine industry in the United States, and every factor of the industry, whether allied or competitive, basks to a certain extent in the reflected glory of the achievement.

THE introduction in the House of Representatives by Representative Kelly, of Pennsylvania, of a new bill to provide for the maintenance of resale prices is naturally viewed with particular interest by piano and talking machine manufacturers, inasmuch as the provisions of the new bill apply most directly to the music industry. While it was hoped by many that the remodeled Stephens bill, with some objectionable features removed, and with provisions made for the supervision of fixed prices by the Federal Trade Commission, would be enacted into a law, it is generally believed now that the Kelly bill, broader in scope and with the objectionable features of the old Stephens bill eliminated, has even a better chance of being passed by Congress and of being enacted into a law.

The bill as it now stands is designed particularly for the protection of trade-marked names and special brands by preventing price cutters from utilizing these trade-marked names, or brands, in the carrying on of their practices to the detriment of the manufacturer of the product. It provides for a number of features, including the sale of excess old style or damaged stock at other than

fixed prices at appropriate intervals, that the dealer in closing out his business may offer goods at less than the fixed prices, provided he has first offered them to the manufacturer, and includes provisions that are practical in their bearing towards possible objections to placing too much power with the manufacturer.

The House Committee on Interstate and Foreign Commerce, to which the Kelly bill has been referred, is expected to hold hearings on the measure in the near future, and it is expected that the music industry will be well represented at such hearings. Certain it is that in the talking machine trade at least, and in the piano trade to a considerable measure, the growth of the business has depended to a tremendous extent upon the maintenance of prices, and that its future progress likewise depends in no small measure upon some form of protection against those who cut prices and by so doing tend to cast discredit upon trade-marked names and special brands of the industry that have become household words throughout the country as a result of millions of dollars spent in advertising them. If any evils ever resulted from the old systems of price maintenance, it is quite certain that they were far more than offset by the benefits recurring therefrom. The progress of the Kelly bill, in view of the existing situation, will be watched with interest.

THE importance of advertising as one of the essential factors to success in business is too obvious to need reiteration. Every progressive man to-day realizes that advertising does two things primarily—it creates a demand, and more important still it establishes a name value that is worth hundreds, thousands, or millions of dollars as the case may be, because it cost that much to create it.

No more striking illustration of the value of advertising can be adduced than the following paragraph written by M. P. Gould:

"The best known commercial agency in the country, an organization that does nothing but investigate business conditions, recently announced that 84 per cent. of the failures in the country were among non-advertisers. If ever there was conclusive evidence of the absolute necessity for advertising one's business, here it is . . . 'Out of every 100 failures 84 had done no advertising.' This tells the story!"

IN Grand Rapids, Mich., just now there is being held the first talking machine or phonograph exhibition, with close to two score manufacturers of machines, records and accessories represented. The exhibition in Grand Rapids is indicative of two things. First, that that city has become one of the recognized talking machine producing centers in the United States, and second, that the industry has developed sufficiently to make an exhibition of such size and character worth while, and sufficiently diversified to make it interesting. It is more than likely that an annual show of this character will become a feature of the trade, just as the holding of semi-annual furniture expositions is recognized as an institution. It is just one more bit of proof of the growth of the industry.



Cellars and Sellers

CELLAR service will soon need traffic cops to regulate it. You know! We don't have to even whisper.

But Seller Service we like to holler about. Some Prohibition specials can now be imbibed! Drink to Me Only with Thine Eyes; The Stein Song, "Simon the Cellarer," and others.



SILAS E. PEARSALL COMPANY

DISTRIBUTORS

WHOLESALE ONLY

Victrolas and Victor Records 10 East 39th Street, N. Y.

Observations on Various Plans of Increasing the Sale of Talking Machines :: :: By W. B. Stoddard

The Ankeny Drug Store, Corning, Iowa, which handles a standard line of Victrolas and a wide selection of records of all prices, has a novel way of increasing its business, which could be practiced to advantage by any firm dealing in talking machines whose territory included a farming community. The manager fitted up a runabout on which he could carry a talking machine, and whenever he could arrange to get away from the store he was outside soliciting business for that department. He found this branch of business a money-maker, and limited only by the time he could put in soliciting—in other words, the more time he put in the larger the sales. "After supper calls are very convenient for the farmers," he said. "At that time of the day the farmers have nothing to do, and are glad to have a caller to relieve the monotony of the evening. They can spend plenty of time listening to the demonstration and are more in the mood to buy than they would be if approached during the day."

The White Pharmacies, of Clinton, Ind., are another drug concern that have made a decided success in selling talking machines. Speaking of the way in which they have built up a substantial trade, C. M. White, Jr., said: "We had the floor space in the rear of the store, just off the prescription counter, so we built a demonstration room, took the agency for two kinds of machines and put in a stock of records. At first we thought that the regular store help could take care of this department, but we soon found that it takes more salesmanship to sell talking machines and records than to wrap up a cake of toilet soap. We therefore decided that in order to take care of the talking machine business which we were building we would

employ a young woman to devote her entire time to it. Business greatly increased on taking this step, as patrons felt no hesitancy now in asking to have certain records, since they do not take a busy drug clerk from his regular work." Mr. White also said that as Clinton is an industrial city, with a large foreign population, the store keeps on hand a large number of records in foreign languages and likewise runs advertisements in the foreign paper, inviting the patronage of these aliens and advising them that at the White Pharmacies may be found records in their native tongues.

Henry Ford was once accused by a number of manufacturers of the more expensive and luxurious type of automobiles of ruining the market because he put out such a low-priced car. "Gentlemen," said the astute magnate, "you are entirely mistaken. As a matter of fact I am your very best advertising agent. When a man first gets the auto 'bug' he buys a Ford. After he finds out the delights of autoing and the possibilities of a car he wants one of more expensive type—and there you are. Thousands of men would not now be patronizing you if they had not first owned a compact little 'flivver.'" It was this species of reasoning that induced a Chicago concern to push a baby model of talking machine. They realized that many people who did not feel able to buy a high-priced instrument would put a moderate amount into a machine for the sake of the recreation it afforded—and once they had come to a realization of its possibilities they would be more than willing, later, to pay an increased price for a higher-grade instrument.

A well-known dealer in talking machines and records in Dayton, O., who does a large time-

payment business, has hit upon an excellent plan of avoiding dunning a customer, and at the same time seeing that he was not lax in his payments. Shortly prior to the date on which a payment was due a printed card was sent, inviting the recipient to drop in and hear the new records—a list of which was printed on the same side. On the opposite side was written: "Inasmuch as the next payment on your talking machine is due June 17 (or whatever the date might be) I shall be glad to have several of these records set aside for your inspection when you visit us on that date to settle your account." This gentle reminder seldom failed of its purpose, as the firm generally knew the type of music preferred by each patron and made a careful selection.

That an excellent business may be done in a small town—especially if it is the center of an agricultural neighborhood—has been proved by Timothy Sammons, of Triumph, Minn. Mr. Sammons emphasizes the personal side of the business. He knows everyone in town and most of the surrounding country. "When I go to the city for my semi-annual buying trip I remember all the friends back home with picture post-cards. Last winter when my son and I made the trip we went into a place where they made post-card photos. I secured a large number of these and had printed on the card:

"Alden and I are in the Twin Cities buying a large selection of new records. We will have them on display and ready to be demonstrated at our store next week, and hope you will call and hear them."

This personal interest pays big, especially in a small town, and this postal card plan, with variations, could be used to advantage in hundreds of towns and small cities.

The latest, most intelligently constructed lateral record in the world

The only true lateral record on the market without a machine tied to it

The New Lateral Record

made by

THE LIBERTY PHONOGRAPH COMPANY

Like fine painting or jewelry does not come in bulk

AS in masterpieces of art, the superiority of this record is the result of infinite pains and faith in the inherent desire of men and women to have the best that human minds and hands can make.

It is not a record for people who like the cheap, the tawdry, the commonplace—but for those who appreciate and cherish the fine and beautiful things in life.

The output of this record, like the output of the Rolls-Royce car, is limited because master work can not be done in quantity.

We recommend that distributors write us, planning six months in advance to handle The New Lateral Record.

LIBERTY PHONOGRAPH COMPANY

Executive Offices: 1836 EUCLID AVENUE, CLEVELAND, OHIO

Laboratory: 16-18 West 39th Street, New York, N. Y.



Open your heart to the world's great music! *Through the Victrola!*

Galli-Curci, Melba, Sembrich, Tetrassini sing "Caro Nome"

Let any one of them sing to you, through the Victrola, this exquisitely tender aria, which is one of the rare jewels of opera. Its haunting beauty will find a place—strike a sympathetic echo in *your own* experience.

To appease the hunger for beauty which lies deep in every one of us—that is the mission of the Victrola, and to do so the Victrola has enlisted the genius of the world—the most supremely gifted singers and instrumentalists of our generation.

Can you afford to miss the daily pleasure, the heart's-ease that the Victrola so abundantly gives, and which is always yours to command in your personal hour of need?

Victors and Victrolas \$12 to \$950. There are Victor dealers everywhere and they will gladly play for you any music you wish to hear.

Victor Talking Machine Co., Camden, N. J., U. S. A.

Important Notice: Victor Records and Victor Machines are scientifically coordinated and synchronized in the processes of manufacture, and their use, one with the other, is absolutely essential to a perfect reproduction.

New Victor Records demonstrated at all dealers on the 1st of each month

"Victrola" is the Registered Trademark of the Victor Talking Machine Company designating the products of this Company only.

Gilda singing "Caro nome" in Rigoletto



WHEREVER you look you see Victor advertising. Magazines, newspapers, farm papers, educational publications—all carry the Victor message every month in the year. Constantly stirring up new business for Victor retailers in every part of the country, creating good will that is a valuable asset for them, and adding to their profits. Back covers and color pages play a prominent part in the Victor advertising campaign, and the attractive advertisement shown above greets the readers from the back covers of such magazines as Literary Digest, Collier's, Life and Theatre. It possesses an atmosphere of quality that impresses the public with the high artistic achievements of the Victor Company.



Victrola Records voice the mighty

To speak the language of music in the sweetest tones that spring from human lips, or are charmed from an instrument by the skill of a master's hands—that is the province of Victrola Records.

They are true tone-portraits inscribed with the priceless art of the most famous singers and instrumentalists this generation has produced. The genius, the power, the beauty of every voice and every instrument—all are inherent in Victrola Records. They present a stupendous musical review displaying the diverse gifts

possessed by
Victrola Records
absolutely
There are
Victrolas and

Important Notice.
coordinated and synchro-
use, one with the other



1 Caruso as Rhadames in Aida 4 Gluck as Nedda in Pagliacci 7 Schumann Heink as Anzóna in Trovatore
2 Farrar as Tosca 5 Galli-Curci as Gilda in Rigoletto 8 Homer as Amneris in Aida
3 Melba as Marguerite in Faust 6 McCormack as Sir Edgar in Lucia 9 De Luca as Figaro in Barber of Seville

Victrola XVII, \$275
Victrola XVII, electric, \$3
Mahogany or oak

AMONG the most dominating Victor magazine advertising is that done on center spreads. The one shown above which appears in the Saturday Evening Post and Literary Digest tells the story of Victor Supremacy through its wonderful group of famous and exclu-

Power of the world's greatest artists

the greatest artists of all the world. A privilege exclusive with records—a distinction conferred upon them in recognition of their like reproduction.

Victor dealers everywhere and they will gladly play any music you wish to hear. Victrolas \$12 to \$950.

Victor Talking Machine Company, Camden, N. J., U. S. A.

Victor Records and Victor Machines are scientifically made in the processes of manufacture, and their quality is absolutely essential to a perfect reproduction.

"Victrola" is the Registered Trademark of the Victor Talking Machine Company designating the products of this Company only.

New Victor Records demonstrated at all dealers on the 1st of each month.



PHOTO BY
EFT DUFORT
MISHKIN
POLLY
GEORGE DAVIS & SANFORD
APEDA
HATZENE

10 Ruffo as Rigoletto 13 Aida as Desdemona in Othello 16 Calvé as Carmen 19 Tetrazzini as Lakmé 22 Efrem Zimbalist
11 Martinielli as Mario in Tosca 14 Scotti as Scarpia in Tosca 17 Fritz Kreisler 20 Mischa Elman 23 Braslaw as Marina in Boris Godunow
12 Lenace Jan Padernewski 15 Jascha Heifetz 18 Journet as Mephistopheles in Faust 21 Garrison as Olympia in Tales of Hoffman 24 Whitehill as Amfortas in Parsifal



"HIS MASTER'S VOICE"
REG. U.S. PAT. OFF.

To insure Victor quality, always look for the famous trademark, "His Master's Voice." It is on all products of the Victor Talking Machine Company.

sive Victor artists. The fact that the greatest artists of all the world make records only for the Victor Company is not only conclusive evidence of the perfection of Victor products, but is one of the most potent factors in the unparalleled success of Victor retailers.



Out to-day New Victor Records for June

A splendid variety of music! Famous and exclusive Victor artists in new presentations of old favorites that you always love to hear. Exquisite new numbers that will charm you by their beauty. The choicest of the latest popular songs are also in this new list, and dance music that has a most enticing swing. You can hear any of these new numbers at any Victor dealer's!

Title	Artist	Number	Size	Price
Baby Mine	F. No.	64160	10	\$1.00
Caprice Poetic	F. No.	71900	12	1.50
Quartet in A Minor—Scherzo (K. Sebastein)	Alfred Cortot	74578	12	1.50
Twilight	Flonaky Quartet	64507	10	1.00
Marchones, Your Dancing	Amelia Galli-Curci	62611	10	1.00
The Little Old Log Cabin in the Lane	Mabel Garwood	64509	10	1.00
Spanish Dance	Alma Gluck	74509	12	1.50
I Love to Tell the Story	Jascha Heifetz	67301	10	2.00
Dream of Youth	Laura Homer	64710	10	1.00
Life and Love (from "The Velvet Lady")	Fritz Kreisler	64164	10	1.00
Waiting (from "Lullaby")	Lambert Murphy	18540	10	.85
By the Camp Fire	Peetles Quartet	18541	10	.85
For Forever Blowing Bubbles	Joe C. Smith's Orchestra	18543	10	.85
The Royal Vagabond—Medley Fox Trot	Joe C. Smith's Orchestra	18543	10	.85
Canary—Medley Fox Trot	Joe C. Smith's Orchestra	18544	10	.85
Dear Old Pal of Mine—Waltz	Charles Hart	18544	10	.85
When You Look in the Heart of a Rose—Waltz	Henry Burr	18545	10	.85
Tears of Love	Sterling Trio	18545	10	.85
Wait and See	Lewis James and Peetles Quartet	18546	10	.85
The Tumble-down Sheek in Athlone	Frantzen's Society Orchestra	18547	10	.85
Smile and the World Smiles With You	Sidley One-Step	18547	10	.85
Sweet Samese—Fox Trot	Frantzen's Society Orchestra	18548	10	.85
He's Had No Lovin' for a Long, Long Time	Patric	18548	10	.85
You'll Find Old Daveland in France—Medley Fox Trot	All Star Trio	18548	10	.85
Just Blue—Fox Trot	Victor Military Band	18550	10	.85
Rhythm Medley No. 1	Victor Military Band	18550	10	.85
Rhythm Medley No. 2	Victor Military Band	18550	10	.85
Hush—byr, Ma Baby—Missouri Waltz	Vinam Holt and Lillian Reeddale	18550	10	.85
When the Shadows Softly Come and Go	Vinam Holt and Lillian Reeddale	18550	10	.85

Hear these new Victor Records to-day at any Victor dealer's. He will gladly give you all information concerning these new records and play any master you wish to hear. We recommend the Victor Talking Machine Company's 100 to 300 records without changing. Victor and Victrola in great variety from \$12 to \$350.



A new Victrola Record by Caruso, Homer and Journet

A record that deserves a place among the
concerted numbers in the Vi
record that



Caruso's power and wit!

the mightiest music
the drollest comedy.
amut of music and
you go in the great
art, the merriest
the brain and heart
privilege if you have
seen by the world's
medium of their



Caruso sings at Auditorium May

Hear this famous Vic

This Caruso recital is an event of two to the music-loving public.

- (1) It presents the opportunity of hearing the voice of this great tenor.
- (2) It enables you to compare his interpretations on Victrola Records.

Hear Caruso at this recital. The dealer's and hear the Victrola Record will instantly appreciate how truly the his personality and his art.

You will readily understand why records only for the Victor Company is this fidelity of reproduction which artists to make Victrola Records ex



Hear these famous Victor artists Galli-Curci at the Metropolitan Opera House on May 10 Elman at the Metropolitan Opera House on May 11 Then hear their Victrola Records

Extraordinary interest attaches to the recitals of these great artists because of the double opportunity they afford the music-loving public.

It is a privilege in itself to hear these famous artists, and added importance is given to the events in that they enable you to compare their exquisite interpretations with their Victrola Records. Attend the concerts of these artists and note the qualities that distinguish their renditions.



RE-SALE PRICE MAINTENANCE BILL IS BEFORE CONGRESS

Of Interest to the Talking Machine Industry—Provides Protection for Trade-Marked Names and Special Brands—Is Improvement Over Stephens Bill—To Hold Hearing Soon

WASHINGTON, D. C., July 1.—A bill has been introduced into the House of Representatives by M. Clyde Kelley, of Pennsylvania, which treats in a broad way the much-discussed question of price maintenance and resale prices in a way which is expected to meet with the approval of manufacturers. This new bill differs from the former Stephens bill in that it provides for the enforcement of its provisions regarding resale price maintenance. The bill is now in committee and a hearing is expected in the near future. The text of the bill is as follows:

"Be it enacted by the Senate and House of Representatives of the United States of America in Congress assembled, That in any contract for the sale of articles of commerce to any dealer, wholesale or retail, by any grower, producer, manufacturer, or owner thereof, under trade-mark or special brand, hereinafter referred to as the 'vendor,' it shall be lawful for such vendor, whenever the contract constitutes a transaction of commerce among the several states, or with foreign nations, or in any territory of the United States, or in the District of Columbia, or between any such territory and another territory, or between any such territory or territories and any states or the District of Columbia, or with a foreign nation or nations, or between the District of Columbia and any state or states or a foreign nation or nations, to prescribe the uniform prices and manners of settlement at which the different qualities and quantities of each article covered by such contract may be resold: *Provided*, That the following conditions are complied with:

"(a) Such vendor shall not have any monopoly or control of the market for articles belonging to the same general class of merchandise as such article or articles of commerce as shall be covered by such contract of sale; nor shall such vendor be a party to any agreement, combination, or understanding with any competitor in the production, manufacture, or sale of any merchandise in the same general class in regard to the price at which the same shall be sold either to dealers at wholesale or retail or the public.

"(b) Such vendor shall file at the office of the Federal Trade Commission a statement setting forth the trademark or special brand owned or claimed by such vendor in respect of such article or articles of commerce to be covered by such contract of sale, and also, from time to time as the same may be adopted or modified, a schedule setting forth the uniform price of sale thereof to dealers at wholesale and the uniform price of sale thereof to dealers at retail, from whatever source acquired, and the uniform price of sale thereof to the public; and, upon filing such statement, such vendor shall pay to the Federal Trade Commission a registration fee of \$10. Prices set forth in such schedule and made in any contract pursuant to the provisions of this act shall be uniform to all dealers in like circumstances, differing only as to grade, quality, or quantity of such articles sold, the point of delivery, and the manner of settlement, all of which differences shall be set forth in such schedule; and there shall be no discrimination in favor of any vendee by the allowance of a discount, rebate, or commission for any cause or by grant of any special concession or by any other device whatsoever.

"(c) Such contracts for the sale of such article or articles of commerce may provide for disposal sales at appropriate times, during which periods, duly set forth in such statement or in such schedule of prices as shall be filed by such vendor, such dealers may sell such article or articles of commerce for a price other than the uniform price as set forth in the schedule provided in the preceding paragraph (b): *Provided*, That such article or articles of commerce shall have first been offered to the vendor by such dealer, by written offer, at the price paid for the same by such dealer, and that such vendor, not less than thirty days prior to the date set forth for the next disposal sale, after reasonable opportunity to inspect such article or articles, shall have refused or neglected to accept such offer.

"(d) Any article of commerce, or any carton, package, or other receptacle inclosing an article or articles of commerce covered by such contract and in the possession of a dealer, may be sold for a price other than the uniform price for resale by such dealer for such quality and quantity as set forth in the schedule provided in the preceding paragraph (b): First, if such dealer shall decide to discontinue the sale of such article or articles of commerce, or if such dealer shall cease to do business and the sale is made in the course of winding up the business of such dealer, or if such dealer shall have become bankrupt or a receiver of the business of such dealer shall have been appointed: *Provided*, (a) That such article or articles of commerce shall have first been offered to the vendor thereof by such dealer or the legal representative of such dealer by written offer, at the price paid for the same by such dealer, and that such vendor, after reasonable opportunity to inspect such article or articles, shall have refused or neglected to accept such offer: *Provided*, (b) That such dealer, or the legal representative of such dealer, shall file at the office of the Federal Trade Commission a statement setting forth the reason for such sale, the refusal or neglect of such vendor to accept such offer, and the grade, quality and quantity

of such article or articles of commerce to be so sold; or, second, if such article of commerce or contents of such carton, package, or other receptacle shall have become damaged, deteriorated, or soiled: *Provided*, That such damaged, deteriorated, or soiled article shall have first been offered to the vendor by such dealer by written offer, at the price paid for the same by such dealer, or at the option of such vendor, in exchange for similar articles not damaged, deteriorated, or soiled, and that such vendor after reasonable opportunity to inspect such article or articles shall have refused or neglected to accept such offer, and that such damaged, deteriorated, or soiled article shall thereafter only be offered for sale by such dealer with prominent notice to the purchaser that such article is damaged, deteriorated, or soiled, and that the price thereof is reduced because of such damage.

"Sec. 2. That the provisions of this act shall not apply in cases of sales of such article or articles of commerce to the United States, or any political subdivision thereof, or in cases of sales of such articles to any state or public library, or to any society or institution incorporated or established solely for religious, philosophical, educational,

medical, scientific, philanthropic, or literary purposes, made in good faith for use thereof by such society or institution. "Sec. 3. That the provisions of this act shall not apply to the sale of any article or articles of commerce from which or from the labels, cartons, or containers of which, there shall have been removed such trade-mark or special brand and all other marks or means of identifications of the grower or producer, and concerning which, in reselling, at wholesale or at retail, no written, printed, or oral statement is made, or any other means whatsoever is employed, whereby such article or articles of commerce are alleged, or claimed, or suggested, or implied to be the product of, or are associated with the name and reputation of any such grower or producer."

MERRIAM CABINET CO. ORGANIZED

At a recent meeting of the newly incorporated Merriam Cabinet Co., Falconer, N. Y., the following were elected directors: B. F. Merriam, John Kroon, J. A. Ruckman, Bernard S. Drake and Harley N. Crosby. The capital stock is \$100,000, consisting of shares of \$100 each. The new concern expects to begin work at once. Contracts have thus far been made only with Thos. A. Edison, Inc.



FEDERAL ELECTRIC SIGN



12 MONTHS TO PAY

You have 12 MONTHS TO PAY for this sign—the first payment brings you the sign.

— INEXPENSIVE OPERATION

The only expense in operating a Federal Electric Sign as shown above, is the cost of the current—a few cents a day.

This sign, being made of porcelain enameled steel, cannot rust, rot or decay. There is no maintenance expense—an occasional washing keeps it sparkling like new.

Easy to read from a distance, this cheerful salesman attracts customers to your store from the cross streets as well as from a block or two in each direction—it tells them who you are, and what you sell, and invites them to trade at an up-to-date store.

Pays for itself many times over in increased business. It works 24 hours a day for you.

Send coupon today—No obligation

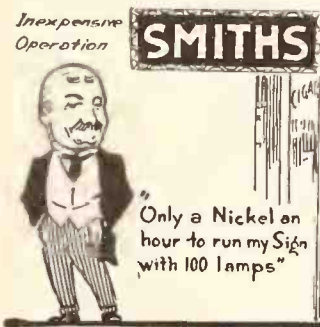

FEDERAL ELECTRIC COMPANY

representing

Federal Sign System (Electric), Lake and Desplaines Sts., Chicago, Ill.

Please send full information on Enameled Steel Sign for my business. Explain your 12-Months-To-Pay plan.

Name Business

Address





No. 175

NO SEASONS for World Phonographs



No. 225

Our Jobbers and their Dealers are selling them by the thousands *NOW*.

Why Not You???

WHERE
QUALITY
REIGNS
SUPREME

*The Home of the
"World"*



*Jobbers Are Invited to
Come and See*

HOW
WORLD
Phonographs
ARE MADE

World Phonographs are better than ever and getting better every day.

That's our policy

Don't forget **WORLD** Records

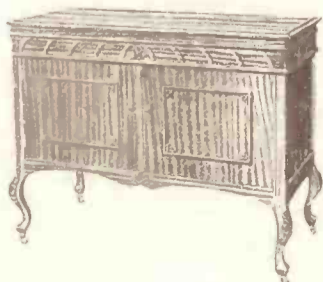

No. 375

WORLD PHONOGRAPH CO.

736 TILDEN AVE.

CHICAGO, ILL.



No. 150

Making the Show Window an Instrumentality of Profit and Prestige :: :: By Warfield Webb

To the more advanced dealer in talking machines the display window has a special significance. It is more than merely a space to fill with something—it must be used to keep the public's interest alive by always looking forward to a new or novel idea to be seen therein. This type of dealer lays particular stress on the value that this publicity space has for his industry, and he sees that it serves his purpose well.

Can he feel that this expenditure of time, cash and energy really does profit him sufficiently to justify it all? Has he any way in which to prove this to be a fact? Yes, there are times when results can be traced directly to the window just as they are found in other forms of publicity—results that are many times even more profitable.

Practically all kinds of publicity are going to cost money. The outlay will depend upon many things and the returns will also be determined by other essentials. The window, however, is, or should be, the least expensive of all publicity items. Much of the success that can be achieved, as in other things that call for profitable returns, will depend upon the attention that is given to make the display one of value. If the dealer only makes an ordinary, commonplace display how can he hope to receive in return more than an ordinary profit from the same? He must work along original lines to win out. And this kind of a window will pay a profit.

Let us take for an example some of the dealers who are giving the matter of unique window display some special consideration. We have in mind one store that does not often overlook an opportunity to take advantage of every incident that will help to increase the sales of records. Any singer of reputation, any musician who visits the city, any event that is of more than passing note, all these are made to serve as only another means of keeping alive the public's interest in records that will become a part of the event. But this is not all. The window is not simply filled with these records, but displays are made at times that will bring this idea forcibly to mind. Something in connection with the event or the person is featured. There is a reason or an invitation given the public to stop and inspect the display.

Does this help to sell records? Can it not be made to act as a reason for the sale of talking machines, too? Will this not be far more effective than an ordinary display that will not do more than cause a glance at the same? The answer must be in the affirmative.

Here is another store. The ideas to be noted are novel. This establishment features records and machines. The display rooms are attractive and the windows are made to offer a help in the sale of late records. In a very recent window display here a feature was made of the prohibition idea. There was a display that brought forcibly to mind the late records that carried the topical songs bearing on this idea. The display was novel, it was attractive and it was timely, too. That is the note that should be sounded. Have it up to date, if anything, and give preference to the late hits that are in the public mind.

Have something in the windows that will appeal and that will make the passerby stop and at least inspect the display. By means of a hint there will be offered a reason for making the looker-in a prospective purchaser of these records. It is the forceful reminder that makes the public buy in many cases. If you do not give them the cue, how can you hope to see them enter your store and ask for a record that would not otherwise be thought of? If you are going to depend upon them coming of their own accord often you will find that there will be a

number of sales missed. The public must be given the hint that makes it think. Do you not fully grasp this in connection with your own purchases?

Why do you at times make a purchase that might otherwise escape you after you have seen it in some attractive window? No, it is this reminder, this face-to-face invitation, that puts it up to you to act then and there. There is

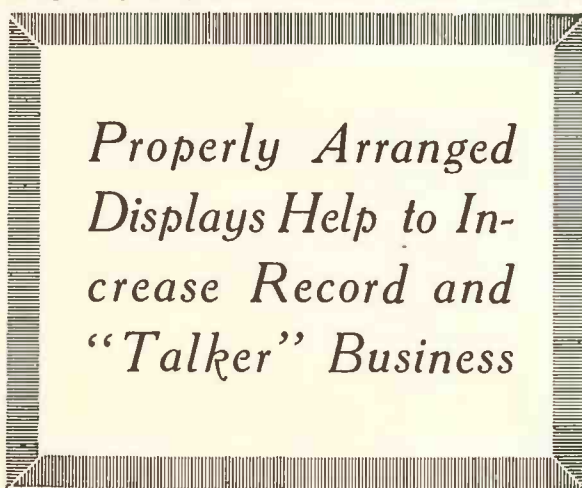

Properly Arranged Displays Help to Increase Record and "Talker" Business

that impelling power that draws you inside the store, and it is often more forceful than any other form of publicity. You want just that reminder that makes it a matter of quick purchase. Had this not been given you at this time—this moment when you were passing that store—you might not, often would not, give it any thought at all.

Therefore, why not offer the public a logical reason for stopping at your store and entering therein? Why not have your window made effective, and in this way force the prospective customer, the one whom you would not even

hope to get in any other manner, to seek you? The first visit might lead to other sales and you can readily see the value of the first sale. It is an introduction to your store. Via the clever window invitation route you come to see that it makes these wavering customers real ones. And that is the object that makes your show window what the name implies. It is to show the public that you are in dead earnest.

Consider the many large stores to-day giving the display feature of their window the proper degree of attention. Does it pay them to do so? Their success indicates that it does. Just think of the vast sum that is annually spent in this one direction to attract and to arouse in the public mind that very special consideration that demands so much of an outlay. If the successful merchants of the country can find it a profitable investment, surely you can.

LEASES FACTORY IN S. NORWALK

The Wonder Talking Machine Co., South Norwalk, Conn., has leased the factory of Berman & Steinberg, wholesale fruit dealers, and the three-story building is well suited for the purpose of the new concern. The Wonder Talking Machine has a plant in New Haven, and the motors are made by a Willimantic firm. The occupancy of the South Norwalk factory will make possible a consolidation which will mean a considerable enlargement of business.

TO HANDLE TALKING MACHINES

The R. A. Lonergan Co. has rented space with the A. C. Schafer Music House, Grundy Center, Ia., and will distribute Edison and Victor machines from this center.

ANY STANDARD PHONOGRAPH and THE BLISS REPRODUCER



"A Wonderful Musical Combination."

A Reproducer with a super-sensitive silk diaphragm that eliminates the thin, raucous, ear-straining "Talking Machine" effect.

The "BLISS" Reproducer plays all records with greater volume, less scratch, better tone balance, and a wonderfully human, natural quality. THE MUSIC IS PROJECTED INTO THE ROOM.

The "BLISS," used on any standard Phonograph, will not only help sales of instruments, but will increase your record trade through its extraordinary tone quality.

Send sample order and make your own tests with your favorite demonstration records. Give make and style of tone arm.

BLISS REPRODUCER, Inc.
80 FIFTH AVENUE
NEW YORK CITY

New August Numbers of Columbia Records

Al Jolson Sings "I'll Say She Does"

Al himself says this song from "Sinbad" is his biggest hit. Does Al know what the public likes? We'll say he does. You'll say so, too, when you hear this record.



A-2746-85c

"Friends"— a Song of Appealing Sentiment



The Sterling Trio sings of a lifetime's friends. Coupled with "I'm Going to Climb the Blue Ridge Mountains Back to You," the greatest love song of this generation, sung by Campbell and Burr.

A-2744-85c

That "JAZZ BABY" Just Has To Jazz

So will you, when you hear Agnes Lynn, the new Columbia comedienne, sing this syncopated riot. Coupled with "I Ain't Got'en No Time to Have the Blues," a tenor triumph by Irving and Jack Kaufman

A-2745-85c



Get the Big August Dance List Ready Now

Every Columbia Dealer Has It

68 Splendid Selections Played by
the Following Great Organizations

- Biltmore Kalaluki Hawaiian Orchestra
- Van Eps Trio
- Columbia Band
- Original Dixieland Jazz Band
- Prince's Orchestra
- Municipal Band of Buenos Aires
- Columbia Orchestra
- Handy's Orchestra of Memphis
- Royal Marimba Band
- Don Richardson Orchestra
- Louise, Ferera & Greenus (Hawaiian Trio)
- Joseph C. Smith's Orchestra
- Blue and White Marimba Band
- Earl Fuller's Rector Novelty Orchestra
- Wilbur C. Sweetman's Original Jazz Band
- Pietro and Guido Deiro (Accordion)
- Vess Ossman's Banjo Orchestra
- Marconi Brothers (Accordion)
- Yerkes Jazarmba Orchestra
- Kopp and Banta (Drum and Piano)
- Jockers Dance Orchestra
- Borbee's Jazz Orchestra
- Columbia Saxophone Sextette
- Yerkes American Marimbaphone Band
- Jockers Brothers
- Louisiana Five Jazz Orchestra
- The Happy Six
- Prince's Band
- Waldorf Astoria Dance Orchestra

"The Lure of Music"

This wonderful book should be in every music-lover's home. It tells you, in a human, interesting way, all about the world's greatest composers and their music—\$1.50 at all Columbia Dealers.

Columbia Records are made in all languages

*New Columbia Records on Sale the
10th and 20th of Every Month
at all Columbia Dealers*

COLUMBIA GRAPHOPHONE CO
New York

London Factory, 102 Clerkenwell Road, E. C.



"Just Another Good Man Gone Wrong"—Fox-Trot



Pepfully played by the Louisiana Five Jazz Orchestra, the newest Columbia combination, which also plays the coupling "Yelping Hound Blues," another irresistible fox-trot.

A-2742-85c

"Tears (of Love)"—One Step "Yama-Yama Blues"—Fox-Trot

"Tears (of Love)," introducing "I'm Glad I Can Make You Cry" and "Pah-jamah," won't make you cry, but dance. "Yama Yama Blues" will make you dance some more.



A-2741-85c

"Mammy's Lullaby"—Waltz "The Red Lantern"—Fox-Trot



The Happy Six plays this perfect waltz, and the Waldorf-Astoria Dance Orchestra this famous fox-trot from the music especially composed for Nazimova's great new motion picture, "The Red Lantern."

A-2747-85c

Columbia Records

Get Speedy Sales from the Splendid Selections on This Special List

HERE'S your chance to keep your customers supplied with the best collection of up-to-the-minute dance music ever compiled by anyone, anywhere, at any time!

Just show them the list of organizations that play these splendid dance selections! It's the best list of dance organizations that ever played for anyone, anywhere, at any time!

We will place the advertisement shown on this page in 250 of the principal newspapers in the U. S., with a total circulation of more than 10,000,000. A full-page advertisement as shown on the opposite page will also appear in the July 26th issue of The Saturday Evening Post.

It's up to you to circulate this supplement among all your customers. In addition to the special dance list it contains a beautiful song by Stracciari, six popular songs and six new dances.

COLUMBIA GRAPHOPHONE COMPANY, New York
London Factory: 102 Clerkenwell Road, E. C.

New August Numbers of Columbia Records



"Just Another Good Man Gone Wrong"—Fox-Trot

Pepfully played by the Louisiana Five Jazz Orchestra, the newest Columbia combination, which also plays the coupling "Yelping Hound Blues," another irresistible fox-trot. A-2742—85c

"Tears (of Love)"—One Step "Yama Yama Blues"—Fox-Trot

"Tears (of Love)," introducing "I'm Glad I Can Make You Cry" and "Pahjamah," won't make you cry, but dance. "Yama Yama Blues" will make you dance some more. A-2741—85c



"Mammy's Lullaby"—Waltz "The Red Lantern"—Fox-Trot

The Happy Six plays this perfect waltz, and the Waldorf-Astoria Dance Orchestra this famous fox-trot from the music especially composed for Nazimova's great new motion picture, "The Red Lantern." A-2747—85c

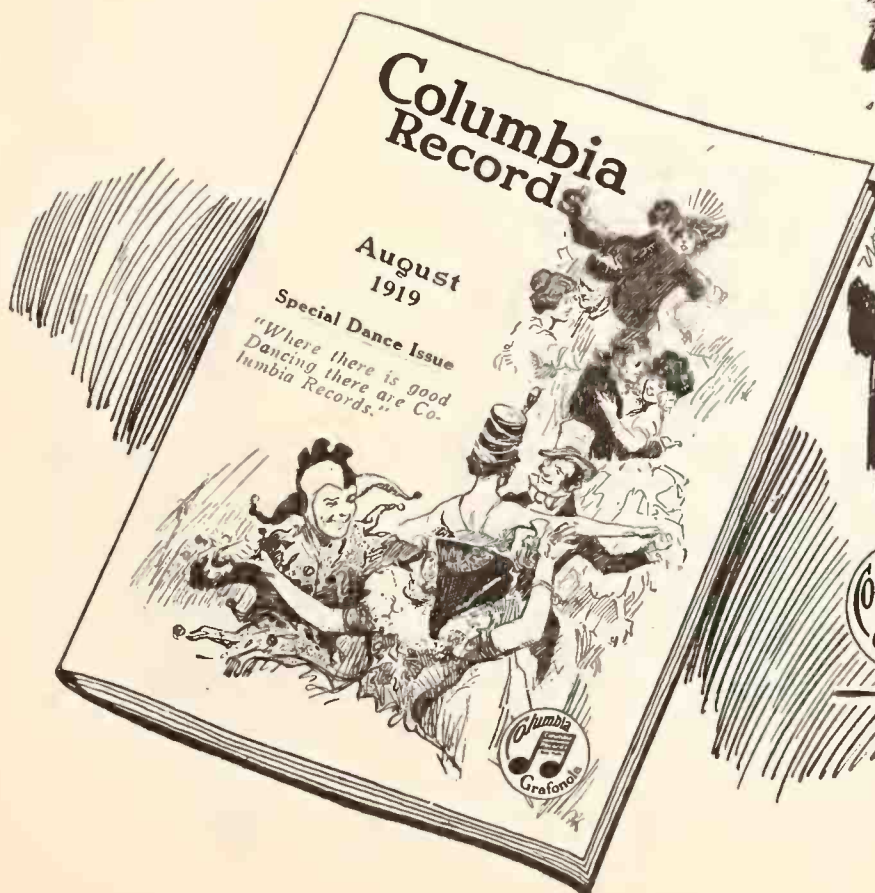

Get the Big August Dance List Ready Now

Every Columbia Dealer Has It

68 Splendid Selections Played by the Following Great Organizations

- | | | |
|---|---|--------------------------------------|
| Columbia Saxophone Sextette | Burke's Jazz Orchestra | Vess Ossman's Banjo Orchestra |
| Columbia Band | Handy's Orchestra of Memphis | Van Eps Trio |
| Joe King's Orchestra | Prince's Orchestra | Marsini Brothers (Accordion) |
| Wilbur C. Sweatman's Original Jazz Band | Prince's Band | Fietro and Guido Deiro (Accordion) |
| Marmaphone Band | Jockey's Dance Orchestra | Baltimore Kalaiki Hawaiian Orchestra |
| Earl Fuller's Rector Novelty Orchestra | Louisiana Five Jazz Orchestra | Blue and White Marmaphone Band |
| Waldorf-Astoria Dance Orchestra | The Happy Six | Munipau Band of Buenos Aires |
| Verkes Jazzband Orchestra | Royal Marmaphone Band | Dun Richardson Orchestra |
| Joseph C. Smith's Orchestra | Kopp and Santa (Drum and Piano) | |
| Original Dixieland Jazz Band | Louise Ferrys & Greenes (Hawaiian Trio) | |



New Columbia Records on Sale the 10th and 20th of Every Month
COLUMBIA GRAPHOPHONE COMPANY, New York

OLD MUSIC IDEAS DOOMED

Use of Talking Machine in School Helps to Overcome Perverted Views on Music

The increasing use of the talking machine in the schools is doing much to dispel certain old ideas regarding the place of music as a part of elementary school education. Not so long ago there were many school teachers and even university professors who believed that in order for a study to be of any value to the students it should be an unpleasant grind. To-day where such ideas prevail they are seldom openly advocated, for they are against the recognized standards of teaching methods.

The fact that well-taught music proves to be an enjoyable study to the average school class is one of the big factors in its being placed on the curriculum and talking machines purchased for school use. Wherever the talking machine has been used in a school it has always overcome the objections raised against it and proved by actual performance its value as an aid to education.

VICTOR JOBBERS MOVE TO HOUSTON

The Talking Machine Co. of Texas, Victor distributors, formerly located in Austin, Tex., will be located in Houston, Tex., in the future. This change was made because of the better facilities in Houston. The Southern Steamship Co. runs a boat each week from Philadelphia to Houston, and with the good rail and express lines in the Southern city the distributors feel that they will be excellently equipped to move their merchandise.

MISCHA ELMAN TO WRITE MUSIC

There is a report current that the famous violinist, Mischa Elman, has turned his attention to writing music and has offered to furnish the music for a play for a prominent prima donna.

"MUSICAL MERCHANDISING" ISSUED

Unit Construction Co. Publishes Booklet Containing Practical Suggestions for Improving Wareroom and Demonstration Facilities

PHILADELPHIA, PA., July 5.—"Musical Merchandising" is the title of an attractive book just issued by the Unit Construction Co. of this city. The excellent arrangement and layout is in entire keeping with the high quality of the line of demonstration rooms and fixtures described. A foreword dedicates the book to the attention of progressive men who have built up and are still developing the young but already tremendous business of providing accessible music for both classes and masses. The volume is profusely illustrated and contains a wealth of practical suggestions for the betterment of the appearance of the wareroom. The pictures shown are not imaginary, but are reproductions of actual installations in every part of the country.

In addition to the portrayal of numerous styles of demonstration rooms there is considerable space devoted to the record counters and racks, arch, lobby and ceiling treatments, panel rails, window and store fronts and case and fixture work for merchandising of every description. The book will undoubtedly be of great value to the progressive dealer. A Pacific Coast branch will shortly be opened under the direction of Donald Monteith, whose temporary address is the University Club, San Francisco.

BEVERLY VICTOR DEALER OPENS

John A. Newell, of Beverly, Mass., has opened a new and enlarged Victrola department in the rear of his present store and has equipped it with three soundproof booths for demonstration of records. For the formal opening he was able to secure from the manufacturers a complete line of Victrolas.

OKEH LANTERN SLIDES READY

May Now Be Obtained From OkeH Record Jobbers—Series of Six Prepared by Otto Heineman Phonograph Supply Co. Ready

One of the latest advertising aids offered to dealers handling OkeH records through OkeH record jobbers is a series of lantern slides, one of which is illustrated herewith, which has been prepared by the advertising department of the



One of Several Lantern Slides

Otto Heineman Phonograph Supply Co., Inc., 25 West Forty-fifth street, New York. Particular attention has been paid to the coloring of these slides as well as their artistic value. They may be used to good advantage in connection with local moving picture performances, and any dealers may procure them from his jobber. There are six slides in the series and they are all admirably conceived.

KAY FEATURES M'CORMACK RECORDS

The Kay Talking Machine Co., 97 Chambers street, New York, recently featured a list of all the records ever made by the famous tenor John McCormack, who is now known as the "great American tenor." This enterprising move aroused much attention.

a combination that makes money for Record Dealers in the Metropolitan territory

Here is the combination:

1. *Advance releases of the big song and dance hits.*
2. *Regular newspaper advertising.*

Can any other combination make more money for record dealers in the Metropolitan territory?

Emerson advertising is appearing regularly in the largest Metropolitan papers.

Emerson releases on the big song and dance hits are regularly first on the market (a recent check-up shows Emerson from one to five months ahead of competitors in the matter of hits).

The Emerson combination of consistent, timely advertising and early releases is one you should not fail to cash in on.

Call Bryant 1656

Emerson Record Sales Company, INC.

Exclusive Metropolitan Distributors

6 West 48th Street, New York City



EXTRA LOUD TONE

FULL TONE

COMBINATION TONE

HALF TONE

LIGHT TONE

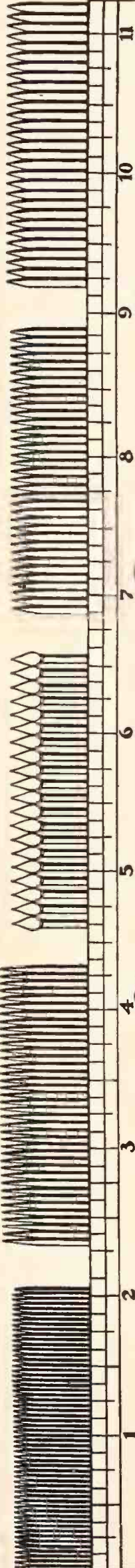

MADE BY AMERICANS

RULE

SUPERIOR STEEL
BRILLIANTONE
 TRADE MARK
 NEEDLES

THE

MADE IN U. S. A.

In Spite of the Larger Profits

BRILLIANTONE

TWO-TONE STEEL COMBINATION FOUR-RECORD NEEDLES

are going Big! very Big!!



They Cost You 4c and Sell for 10c

(per package of 50 needles)

Each needle will play four records, two Soft Tone, and two Loud Tone. The public wants this needle—and properly so. "Combination Brilliantone Needles" are made of the same superior quality steel as all other Brilliantone Steel Needles and will therefore withstand the BRILLIANTONE UNEQUALLED QUALITY TEST of

UNIFORM HARDNESS UNIFORM POINTS UNIFORM LENGTH



Made in America, by Americans

BRILLIANTONE STEEL NEEDLE CO.

OF AMERICA, INCORPORATED

Suite 655-659 Marbridge Building, Broadway at 34th St., NEW YORK CITY

Metropolitan District
 EMERSON RECORD SALES CO.
 366 5th Ave., N. Y. City

Chicago District
 WALTER A. CARTER
 57 East Jackson B'lv'd
 Chicago, Ill.

Pacific Coast District
 WALTER S. GRAY
 530 Chronicle Bldg.,
 San Francisco, Cal.

New England District, "EMERSON, NEW ENGLAND," 68 Essex Street, Boston, Mass.



Al Jolson tops his best yet in "I'll Say She Does." You'll say he does when you hear it. So will everyone else. A-2746.

Columbia Graphophone Co.
NEW YORK

CHANGES NAME TO THE REED CO.

World Phonograph Sales Co. Announces New Name for That Concern—No Change in the Organization—Relic of Airplane Smash.

PITTSBURGH, PA., June 23.—The World Phonograph Sales Co. has announced that the name of this concern has been changed to The Reed Co. This change was decided upon at the last meeting of the board of directors and was thought necessary in order that there should be no confusion of name with other companies. There is no change in the organization and the officers remain the same: W. H. Reed, Jr., president and general manager; A. K. Coulson, secretary and treasurer, and E. H. Miller, vice-president. The Reed Co. has been appointed exclusive distributor for the new Regina in Pennsylvania, Ohio, West Virginia and Virginia. It also distributes Operaphone records, Brilliantone needles, Vallorbes, Wall Kane, Violophone, Tonophone and B. & H. needles, albums and talking machine supplies and Universal player rolls, wholesale.



W. H. Reed, Jr.

A picture is reproduced herewith of a letter

which was damaged by fire in the recent airplane mail accident in the flight from Cleveland

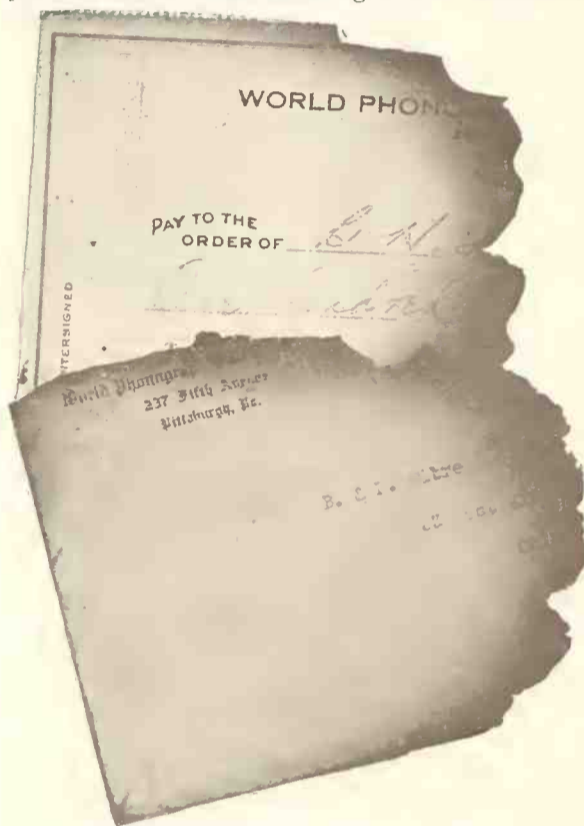

Envelope After Fire Experience to Chicago, in which Frank McCuster was killed. The letter was sent by Mr. Reed to the B & H Fibre Co., Chicago.

BIG INCREASE IN PATHE ORDERS

Visitors at Brooklyn Factory Report Success in Their Localities With the Pathé Products—Trade Conditions Steadily Improving

Pathé dealers calling at the headquarters of the Pathé Frères Phonograph Co., 20-56 Grand avenue, Brooklyn, give glowing reports of the success they are achieving with the line in their various localities.

H. J. Brennan, manager of the Pittsburgh Phonograph Co., spent one day at the Pathé factory recently and said that the demand for Pathé machines and records is limited only by the available merchandise and that he is planning for a record-breaking year. He said: "Trade conditions, as they affect the Pathé phonograph, show a phenomenal increase in the number of orders, and the outlook is most satisfactory, not only in our wholesale and jobbing end, but also in our retail department, which is known as the Pathé Shop. Taken all in all, things are decidedly satisfactory."

Mr. and Mrs. Ed. Allington, Jr., of the Freeport Music Co., Freeport, Ill., were seen at the Pathé factory one day last week. Mr. Allington expressed himself as highly pleased with the outlook for the coming trade season in his territory, and said that he was more than delighted with the sales he had made and those he had in prospect for Pathé.

Mrs. E. Richstaedt, The Pathé Shop, Newport, R. I., another visitor, was most enthusiastic in praise of the popularity of Pathé phonographs and records in her section of the country. She said, "We have been practically swamped with orders for both machines and records and although we have been somewhat handicapped by shortage of material due to wartime conditions, we feel confident that the end of the stringent period is in sight and that there will be a marked change for the better supplying of retail trade in the very near future."

OPENS NEW DEALERS' SERVICE

In order to establish a closer relationship with their dealers, the Emerson Philadelphia Co., distributor of Emerson records, has recently opened a new dealers' service department, which will be conducted solely and exclusively for the convenience of its dealers. This department will handle all correspondence from the trade pertaining to advertising, inquiries, service, etc. Harry Fox, general manager of this company, believes that such a department will fill a long-felt need of service between the distributor and the dealer and do much to stimulate greater interest in the record branch of the talking machine industry.

Dear Mr. Dealer:

You have customers for \$85.00 Phonographs

We have the machine that you want for that Customer. Send for a copy of our Catalog, and let us give you our special dealer proposition.

Paragon Mfg. Co., Inc., Hickory, N. C.

Ward's Khaki Moving Covers



Grade "D" Cover with No. 3 Straps.

Distributors

BRISTOL & BARBER, INC.
111 E. 14th St., New York City

YAHR & LANGE DRUG CO.
207-215 E. Water St., Milwaukee, Wis.

COHEN & HUGHES, INC.,
Washington, D. C.

BECKWITH-O'NEILL CO.
Minneapolis, Minn.

STREVELL-PATERSON HARDWARE CO.
Salt Lake City, Utah

OHIO SALES CO.
Beckman Bldg., Cleveland, Ohio

THE C. E. WARD CO.
(Well-Known Lodge Regalia House)
101 William St., New London, Ohio

Also Manufacturers of Rubberized Covers and Dust Covers for the Wareroom

200,000

Heineman Motors No. 77

Are In Use the World Over

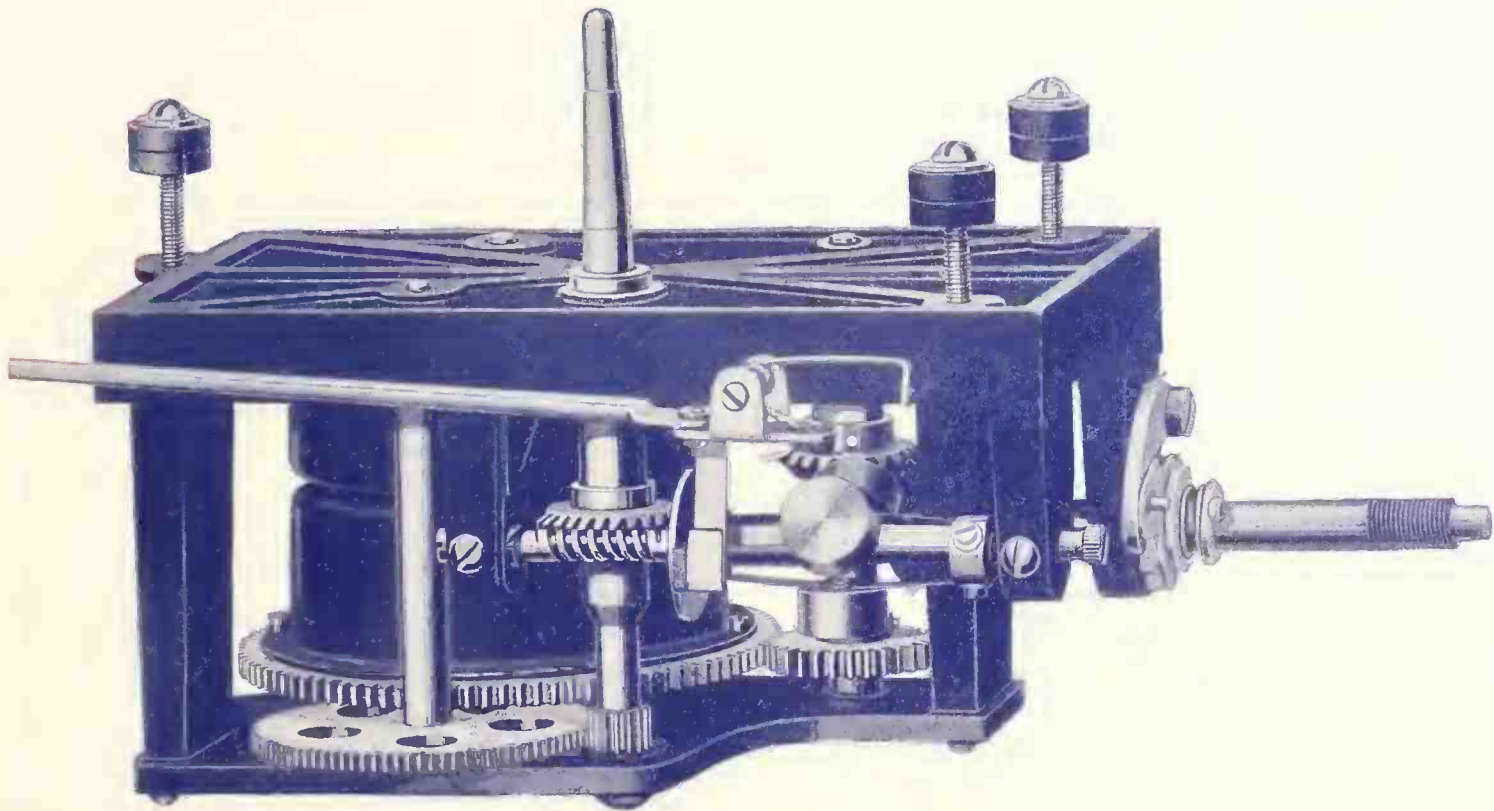

HEINEMAN MOTOR No. 77

A few months ago we advised the trade that the sale of the No. 77 HEINEMAN MOTOR had reached 100,000, but during the past few months the tremendous demand for this motor has enabled us to double our former figure, and today the sale of this motor totals

200,000

Otto Heineman
President

Otto Heineman Phonograph Supply Co.

INCORPORATED

25 WEST 45th STREET, NEW YORK

FACTORIES: ELYRIA, OHIO, NEWARK, N. J., PUTNAM, CONN.
SPRINGFIELD, MASS.

BRANCHES: CHICAGO SAN FRANCISCO TORONTO, CAN.



OKEH RECORDS OF WATSON SISTERS

Otto Heineman Phonograph Supply Co., Inc., Announces That These Talented Young Stars Have Made Four Records of Popular Hits

The Otto Heineman Phonograph Supply Co., Inc., announced this week that the Watson Sisters, well-known stars of the Winter Garden show, "Monte Cristo, Jr.," have recorded four of their most popular song hits for the OkeH



Watson Sisters

record library exclusively. This list comprises the following selections: "Who Played Poker With Pocahontas?" "For Johnny and Me," "When You See Another Sweetie Hanging Around" and "Everybody Wants a Key to My Cellar." These selections will appear in the seventh record bulletin, and, judging from the enthusiastic comments of OkeH dealers who have heard these records, they should meet with a popular reception everywhere.

The Watson Sisters (Fannie and Kitty) have won signal success in "Monte Cristo, Jr.," which bids fair to have the longest run of any Winter Garden show in recent years. These two artists have individual and pleasing personalities, which have been important factors in their success and which are emphasized in the OkeH recordings of their humorous song hits.

The Otto Heineman Phonograph Supply Co., Inc., is planning to institute an aggressive campaign featuring the Watson Sisters' OkeH records and additional selections by these well-known artists will be announced in the near future.

W. B. FULGHUM IN THE EAST

W. B. Fulghum, formerly manager of the Victor sales department for eleven years, and who is now an exclusive Victor dealer in Richmond, Va., recently made a trip East, visiting Camden, N. J.; New York, and Chicago. While in Camden he visited the Victor factory, and during his stay in New York he called on A. D. Geissler, of the New York Talking Machine Co. For the past two years Mr. Fulghum has been successfully retailing Victrolas and Victor records in Richmond, Ind., and his business has continually increased. Mr. Fulghum is an optimist and believes that there are possibilities in the talking machine industry yet undreamed of.

A. J. Oberlin, furniture dealer of Kankakee, Ill., has taken the Victor agency for that city, and has purchased the entire Victor stock of J. J. Rondy. He also handles the Brunswick.

ELECTRO-PLATING of PHONOGRAPH PARTS AND MUSICAL INSTRUMENTS

Silver, Nickel and Antique Finishes
Specializing in GOLD FINISH
JOSEPH MUSANTE
125-131 BAXTER ST. Tel. Franklin 3053 NEW YORK

MCCORMACK AN AMERICAN CITIZEN

Receives His Papers on Anniversary of His Thirty-fifth Birthday—Proud of Honor

John McCormack is no longer to be known as the great "Irish tenor." On June 17, the anniversary of his thirty-fifth birthday, the famous singer and artist received his papers and became an American citizen. The next time he appears on the concert stage he doubtless will be known as the great American singer of Irish songs. Accompanied by his brother, James McCormack, his physician and his pianist, he appeared before Justice Thomas Donnelly in the Supreme Court and took the oath of allegiance to the United States. He was very enthusiastic over the ceremony and declared it to be the happiest day of his life.

Following the court proceedings he and his brother went to the City Hall, where the latter declared his intention of becoming an American citizen also. He gives promise of following in the footsteps of his celebrated brother.

PATHE FOREIGN RECORD DEPT.

Dr. Joseph Kalman, Head of This Department, Predicts Wide Field for Foreign Records

The Pathé foreign record department, under the skilful guidance of Dr. Joseph Kalman, is keeping pace with the phenomenal growth of the Pathé business. Much interest is manifested by the trade in the Pathé foreign line. Many jobbers calling at the factory have carried away with them new ideas suggested by Dr. Kalman that have been of material assistance in increasing that end of their business. Dr. Kalman is a linguist, speaking eight languages fluently, and has been many years in the foreign record business. He understands the diversified tastes of the various nationalities and the proper method of approach for each. With the backing of the Pathé foreign record department he is thus able to co-operate in a most efficient manner in the developing of foreign record sales. Dr. Kalman believes that this field has never had so wide a scope as now.

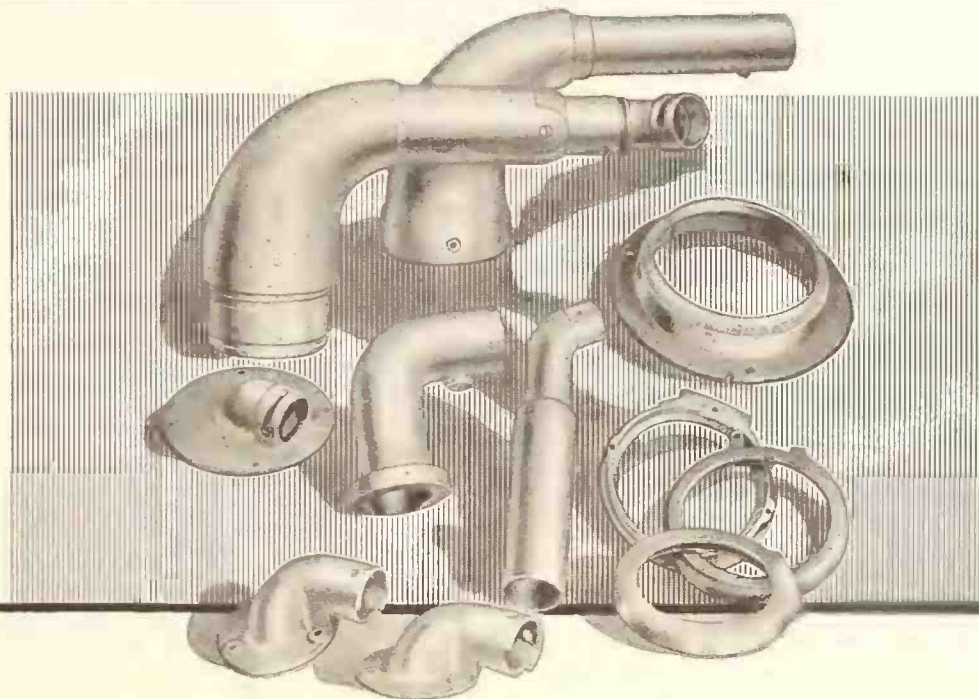

For Rigid Specifications use "Precision" Die Castings, Backed up by "Precision" Service.

In comparing quotations consider the cost of holding a manufacturer to your requirements. "Precision" Service supplies you with castings whose first cost is the only cost.

Select an organization whose mark (PRECISION CAST) on a die casting is the same as STERLING on jewelry. One whose personnel consists of men of long experience and great skill in the art of die casting.

With these men working as close to your engineering staff as a department of your own factory, results are no longer guess work.

Send blue prints or models, and let our engineering department show you how Precision Castings can serve you economically and efficiently.

PRECISION CASTINGS COMPANY, INC.
SYRACUSE,  NEW YORK.

DIE CASTING PLANT, SYRACUSE, N. Y.

Brass, Bronze and Aluminum Foundry, Pontiac, Mich.

PRECISION

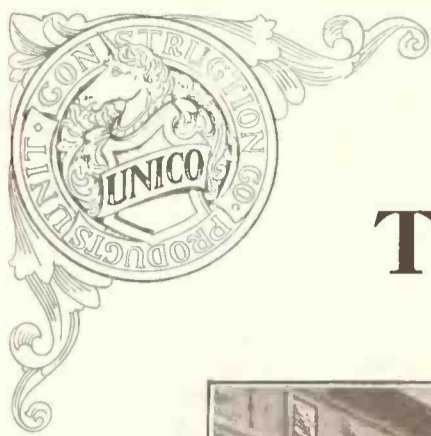

Leadership— The Reward of Best Service

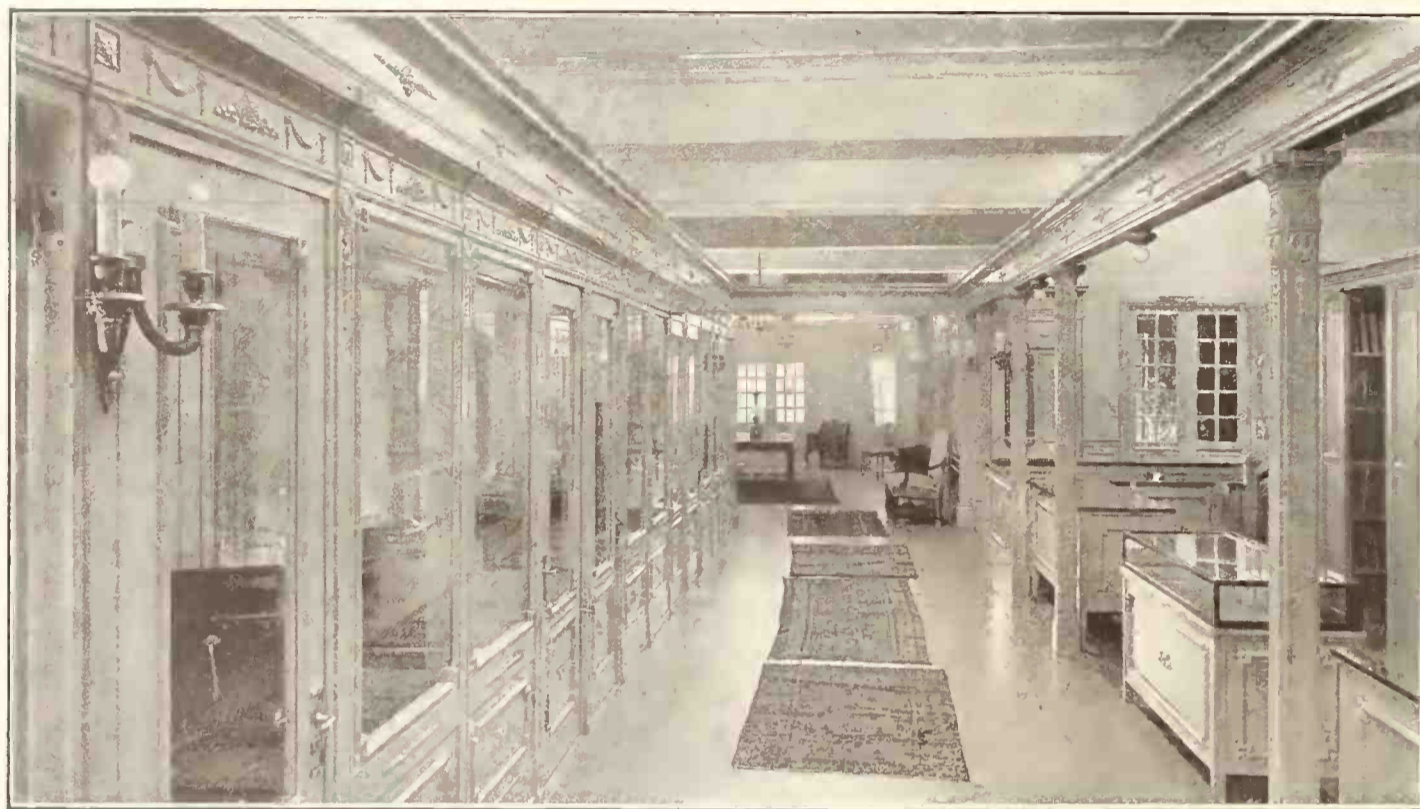

Leadership among retail establishments is the reward that public opinion gives to the store whose customers receive the best service.

Complete service includes not only personal attention, and selling efficiency, but also adequate display.

Unico Equipment will fit your store to give the perfect service that means leadership, both in attractiveness and sales. Unico Counters and Record Racks enable you to produce instantly the records your customers desire.

In the musical field you are selling to your customers' cultural tastes. To complete the appeal, the environment must be artistic.

In Unico Demonstrating Rooms there is that atmosphere of refinement that pleases your customers and unfailingly interests them in your merchandise. They can enjoy the records and instruments undisturbed by street noises and simultaneous demonstrations.

Unico Equipment may be obtained in various artistic designs and finishes to suit your taste. The woodwork is of but one quality, the highest.

Installations are made with a minimum of inconvenience, and as your business grows, new units may be added without detriment to the original investment. Our quantity production makes costs extremely reasonable.

These and many other invaluable Unico features are fully covered in our latest booklet, *MUSICAL MERCHANDISE*—mailed on request.

Send to-day the dimensions of your available space. Plans and estimates for a complete department will reach you promptly.

Address our nearest office

UNIT CONSTRUCTION COMPANY

Rayburn Clark Smith, President

NEW YORK
299 Madison Ave
Corner 43rd St

58th Street & Grays Avenue
PHILADELPHIA

BOSTON: 85 Essex Street

CHICAGO
Lyon & Healy
Building



New Service Bureau of The Talking Machine Men, Inc., Will Be a Great Help to Members

What promises to be one of the most popular features of the sundry activities engaged in by the Talking Machine Men, Inc., is the new Service Bureau established recently by that organization under authority granted at the annual directors' meeting. The Service Bureau is designed to be co-operative to the fullest extent in securing from various members of the organization business forms of different sorts and details regarding special business methods

using a very good card index, showing the history of the payments on purchases. At the time of the purchase the card is filled out with the amount of the sale and date on which each monthly or weekly payment is due. Space is left for the actual date of each monthly payment. A number for every day in the month appears at the top of the card, and the date the payment is due is checked off. A quick glance at the card gives the history of the purchase

the purchaser. This form has proven most practical in actual use.

The above does not by any means cover the work contemplated by the Service Bureau, the plans being arranged to greatly extend its activities. As the dealers receive the benefits from this new service, and give their co-operation and encouragement, it is thought that the activities of the Bureau will be expanded greatly. This move on the part of the Talking

Confidential Statement

For the purpose of obtaining credit from SAUL BIRNS, Inc. I hereby make the following statement:

Name: John Smith Age: 35 Married: Yes Do you live here with your wife? Yes

Any family? Yes Are you a citizen? Yes What class? Local Board No. 1

Order No. 1234 Serial No. 5678 Previous No. 9012 Assembly District No. 3

How long in present address? 5 years Former Residence? 123 St. N.Y.C.

How long in former residence? 3 years Occupation? Teacher

Employer's name and address? ABC Co., 123 St.

Employer's Phone No. 1234 How long with present employer? 2 years

Name and address of former employer? DEF Co., 456 St.

How long with former employer? 1 year Your net worth \$ 1000 Do you belong to any society? Yes

Name and address XYZ Club, 789 St.

Do you belong to a Union? Yes Name and address ABC Union, 101 St.

Do you keep a home? Yes Do you board? No Do you own property? Yes What and where? 123 St.

Do you buy on credit? Yes Name and address of creditor DEF Store, 456 St.

Do you belong to a Bank? Yes Name and address ABC Bank, 789 St.

Recommended by John Doe Through what paper? None

I hereby sign that the said statement is all true. Signed (L.S.) John Smith

Remarks _____

Investigator's Report _____

Sold by _____ Investigated by _____

A Comprehensive Statement

IMPORTANT

Mail or bring the Collection Card when making payment

SAUL BIRNS
111-113 SECOND AVENUE
NEW YORK
PHONE ORCHARD 221-222

Date _____ 1919

Sold to _____ Nationality _____

Letter No. _____ Ledger _____

Name _____

Residence _____

Machine _____ Style _____ No. _____

Price \$ _____ To pay _____

Write out amount at the rate of \$1.00 per month

(In case of default in any of the rate of four quarters, first three may require check. No credit will be allowed when earned home by Saul Birns del. combined acct.)

Day	1	2	3	4	5	6	7	8	9	10	11	12	13	14	15	16	17	18	19	20	21	22	23	24	25	26	27	28	29	30	31	
SAUL BIRNS																																
Letter No. 1234																																
Name JOHN SMITH																																
Address 123 ST. N.Y.C.																																
Machine SAUL BIRNS Co. Model 1234																																
Price \$12.90																																
To pay 10% DOWN																																
10% MONTHLY																																
SAUL BIRNS, Inc.																																

Collection Card (Top) and Store Record

SAUL BIRNS

STYLE XT

SERIES No. 17170

STOCK No. 4

Price \$ 12.90

TERMS 10% DOWN
10% MONTHLY
STEADY

NOT CASH PAID 115

The Price does not include my Patent

Tested and Paired before delivery by Saul Birns

Sold to _____

Address _____

Delivered on _____

Style _____

Price \$ _____

Exchange _____

Down _____

Monthly _____

Weekly _____

Received from _____

in cash payment of _____

SAUL BIRNS, Inc.

A Good Price Card

REPAIR TICKET

No. 1227 Date _____

Call on M _____

Address _____

On _____ Time _____

To Repair Machine _____

Bought here _____ Acct. still open? _____

Ledger No. _____ Order No. _____

What Machine? _____ Lens Part? _____

Repair _____

Parts used \$ _____

Time \$ _____

Total Charges \$ _____

When promised _____

Remarks _____

Call on M _____

Address _____

On _____

To Repair Machine _____

Bought here _____ Acct. still open? _____

Ledger No. _____ Order No. _____

What Machine? _____ Lens Part? _____

Repair _____

Parts used \$ _____

Time \$ _____

Total Charges \$ _____

When promised _____

Remarks _____

SAUL BIRNS, 111 Second Ave.

Triple Repair Ticket

that have proven successful, and making such forms and methods available to the other members of the body.

The committee in charge of the Service Bureau is composed of Irwin Kurtz and J. J. Davin, and these active workers have had the assistance of a number of the prominent local talking machine jobbers and retailers in carrying on their work. As a result there is already on file at the Bureau a most interesting collection of practical business forms, and other material calculated to conserve time and effort, and make for efficiency. There is sufficient variety of this material to meet almost any normal request.

The Talking Machine Men, Inc., already have over 25,000 standardized contracts in printed form. These are sold to the members of the association at a very small cost, and afford the dealer the maximum protection under the laws of the States of which the membership of the organization is composed, including New York, New Jersey and Connecticut.

Among the material that has been accumulated is a form of confidential statement to be filled out by the applicant for the purchase of a talking machine on instalments. This gives a complete record of the prospective purchaser and his history, including nationality, age, family, address, etc., employer's name and address, phone number, length of time in his employ, the name of former employer, whether the applicant belongs to a lodge or union and whether he owns any property, and whether he is at present a debtor to an instalment house. There is also a space for the names and the addresses of relatives and friends whom the applicant has known for three years.

A very good repair ticket is also available. This ticket is in three parts, one for the repair man, one for the office, and one for the customer, and gives the total record of the article to be repaired, time of delivery, etc.

Some of the dealers for some time have been

and the condition of the instalments.

A price card, which includes the minimum instalments which will be taken for the machine, is also receiving the support of the new Service Bureau. This card is perforated into three parts: one is a price tag; one is for the history of the sale, including the delivery, terms, and the name of the salesman, as well as the date, and the third is to be filled out as a receipt to

Machine Men, Inc., is a good one. It is constructive, educational and tends to raise the standard of the business practices followed by dealers. Those heading the committee are very active, and the results accomplished in so short a space of time are to be commended. Without doubt, under the present regime, the work will be greatly extended and all dealers will benefit by the new service bureau.

He Wouldn't Buy the New Machine Without a

VEECO MOTOR

That is why a private owner who had used a **VEECO ELECTRIC MOTOR** in his talking machine for 3 years and was going to sell it (including **VEECO MOTOR**) and purchase a high-class phonograph of another make refused to buy it until we assured him that a newest type **VEECO MOTOR** could be installed therein—that's satisfaction.

The improved **VEECO** electric motor is designed primarily and exclusively for Talking Machines. It is smooth and noiseless in action and practically fool-proof. Standard models run on any voltage from 100-125, A. C. or D. C., without adjustment. Other models for any voltage from 6-250. Furnished mounted on 12 or 12½ inch mahogany board ready to install, or without board, all ready to mount on such board as used by the manufacturer.

With the **VITRALOID** turntable, supplied with the motor, it makes a complete motor unit for high class machines.

THE VEECO COMPANY 248 Boylston St. BOSTON, MASS.

THE ORIGINAL PRODUCERS OF A COMPLETE ELECTRIC DRIVE FOR TALKING MACHINE MANUFACTURERS' USE

HOW TALKING MACHINE AIDS IN NEW PSYCHOLOGY TESTS

Musical Capacity of the Individual Can Be Determined, Says Dr. C. E. Seashore in His Recent Demonstrations—Series of Records Prepared by Columbia Co. Used in Tests

The employment of the talking machine in working out experiments in psychology to determine the musical capacity of an individual has been successfully tried by Dr. C. E. Seashore, who has issued a booklet, called "A Manual of Instructions and Interpretations for the Measure of Musical Talent," which is used in conjunction with a series of five records prepared by the educational department of the Columbia Co. Dr. Seashore recently demonstrated his theories before the National Music Supervisors' Association in St. Louis, at which time he tested the musical talent of a class of school children. Following this he made a test of several persons in the audience, who were later given a chance to correct their own charts. The demonstration met with the highest approval of those present, and many expressed their belief that the future possibilities of Dr. Seashore's methods were almost unlimited and would be of great value in aiding in the education of our school children.

Dr. Seashore used the talking machine as the best medium for his test, because of the accuracy with which this instrument records even the slightest sounds. The first machine used for making the test was an expensive device, which could not have had a widespread use due to its prohibitive cost. By using the talking machine and Columbia records he believes that to-day these remarkable tests of musical talent are brought within the means of any school in the country. That the educational institutions of our country are not slow to realize the great value of this testing device is shown by the fact that several universities, many preparatory schools and a large number of the grade schools of the country have already adopted it.

Within the covers of the "Manual of Instructions and Interpretations for Measure of Musical Talent" there is a treatise on how the records are used and how to make charts of the students to be tested. There is also an introduction on the nature and use of the measure of musical talent, which reads as follows:

"Just as the great musicians live before us now in the wonderful reproduction of the modern phonograph, so the intricate experiments of the psychological laboratory may now be popularized by the faithful reproduction of the sounds of laboratory instruments and their scientific presentation.

"Musical talents vary enormously, both in degree and kind. Many of these capacities can be measured before musical education has been begun. It is of inestimable value for the art of music that these capacities and traits should be discovered early and be analyzed for the purpose of guidance in musical education. The material presented in these records furnishes measures for five of the most fundamental and essential capacities of the musical mind. As we may hear the prima donna sing in school and home, so we can command the scientific means for aid in the detection, analysis and rating of musical talents.

"These measures of musical talent comply with the following conditions: They are based on a thorough analysis of musical talent; they are standardized for content that does not need to be changed; they give quantitative results which may be verified to a high degree of certainty; they are simple and as nearly self-operating as possible; they are adapted for group measurements; they take into account practice, training, age and intelligence; they have a two-fold value in the concrete information furnished, and in the training and pleasure gained from the critical hearing of musical elements.

"These measures are adapted primarily for use in the regular music course and for special surveys in the public schools. They should be used first in the fifth grade, because this is the earliest age at which group measurements can be made satisfactorily, and it is early enough to make serious arrangements for a musical edu-

cation. They should then be repeated in the eighth grade, just before the great sorting of children into the vocations of practical life and elective courses in the high school.

"They furnish also material for scientific entertainment in the home. Taking one test each evening this outfit provides material for five evenings of delightful entertainment in the form of a competitive game.

"For teaching purposes the tests furnish excellent class experiments in elementary psychology. If the performance of each of these tests is linked with the corresponding chapter of reading in the 'Psychology of Music Talent' this will furnish five days of intensive training in the measurement of individual differences. These class experiments, with required readings, will also fill a great need in the theoretical instruction in the music school. Such use of them will not conflict with the previous

use in the entrance examinations in any way.

"All the test material for this series is contained on the five double-disc records. The measures are so adjusted as to be easy enough in parts for the poorest listener, and difficult enough in parts for the best listener. A measure consists in the playing of both sides of a disc. The playing of one side takes from four to five minutes. The material is so ordered as to regulate natural periods for the flow of attention.

"The disc may be played on any good standard phonograph, provided the instrument is in good, smooth running condition, properly set, balanced and lubricated. A first-class phonograph, well regulated, runs with an error of less than one-thousandth of a second per revolution. Care about winding is necessary. The instrument should be set for seventy-eight revolutions per minute for all the records except that of the sense of time; for that it should be set at sixty or sixty-five. Loudness appropriate to the room may be varied by proper selection of metal needles. Pupils should be supplied with test blanks in order to keep records."



OKEH

RECORDS

IMMEDIATE DELIVERIES

OF ALL

Popular Hits

Every dealer handling OkeH Records is ready to give efficient service to his patrons and supply them *immediately* with the best sellers of the day.

We are giving our dealers valuable service and co-operation and the "Record of Quality" is winning new friends steadily.

Do You Know What Our Service Means?

THE GARFORD MFG. CO.
ELYRIA, OHIO

What the name

Krasberg



has stood for in mechanical production during many years

Silent Power

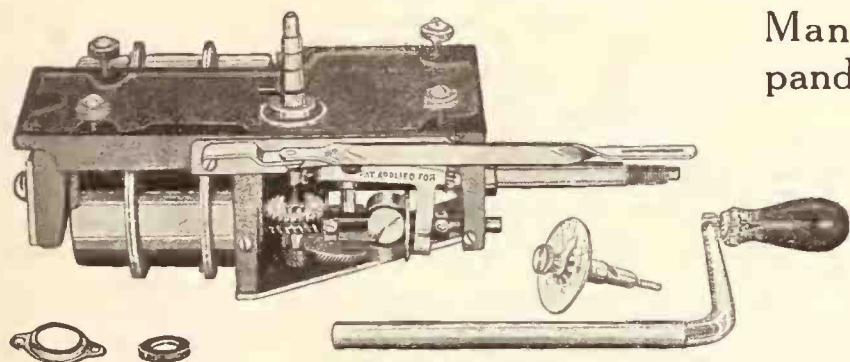

No. 4 Motor

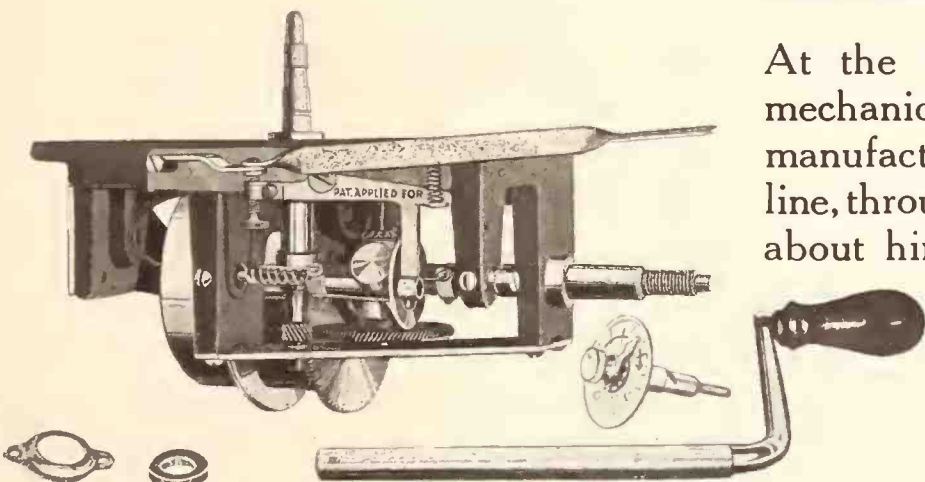

No. 2A Motor

RECENTLY announcement was made by the Krasberg Engineering and Manufacturing Corporation of its expanded facilities for the production of talking machine motors.

This concern, occupying an enviable reputation in the tool and machinery trade, has long been known for its thoroughgoing efficiency in the administration of its business and the manufacture of its product.

At the head of the concern is a master mechanic, a specialist in special machinery manufacturing—and all the way down the line, throughout his factories, he has gathered about him men of his own type, capable of turning out master products.

Several years of motor manufacture for some of the largest talking machine concerns in the country have evolved a motor second to none, incorporating the improvements and backed by the ideas of the

KRASBERG ENGINEERING AND MANUFACTURING CORPORATION
CHICAGO



DIDN'T NEED THEM AFTER ALL

Traveler From the United States Found That His Spanish Records Were Unnecessary

An interesting light on the trade conditions between the Northern and Southern halves of our continent is found in the following story told by an American business man about his first experience as a traveling representative in South America for a North American concern. He had but a slight knowledge of Spanish and in order to help him in his work he had made a series of records designed to explain his business to the natives in their own tongue. When he arrived in South America and called on his men he started the records telling his story. His hearers listened respectfully until the last record had been played. Then they told him in very good English that they had enjoyed the performance, but they were perfectly capable of continuing the conversation without the aid of an interpreter.

RECORDEON CO. BUYS NEW PLANT

Walter H. Schwab and Edward A. Heaney have purchased the plant of the American Auto Body Co., Thirty-ninth and Villard avenues, Milwaukee, Wis., and will start a factory for the manufacture of talking machines. The new concern is known as the Recordeon Phonograph Co. and is capitalized at \$100,000. The plant of the Minn Billiard Co. was purchased by the same men last December, also for the manufacture of talking machines.

FAULTLESS CASTER CO. BUSY

Work is being rushed on the new quarters of the Faultless Caster Co., Evansville, Ind. The new steel stockroom is nearly completed and the office building is steadily assuming large proportions. This building is a two-story and basement structure, finished in wood and steel inside and pressed brick on the outside.

VISITS DEALERS BY AIRPLANE

D. A. Rankin, of Tarkio, Mo., Travels From His Home to Kansas City to Place Order for Machines and Records in That City

Last week D. A. Rankin, of Tarkio, Mo., came to Kansas City by airplane to purchase some Grafonolas. Mr. Rankin, whose home is about one hundred and forty miles from Kansas City,

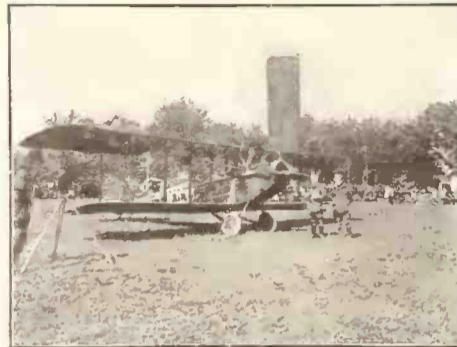

The Airplane as a Sales Factor made the trip in less than two hours. While in Kansas City he placed a substantial order for Grafonolas and records. The accompanying photograph shows Mr. Rankin just a few minutes after returning to Tarkio. He claims that by systematically calling on the Columbia branch in Kansas City in this manner he will be able to obtain all the Grafonolas and records he desires.

TO EXHIBIT MANDEL PHONOGRAPH

The Mandel phonograph, made by the Mandel Mfg. Co., Inc., Chicago, Ill., will be exhibited at the Chicago Market in July in the Chicago Furniture Exhibition Building, 1411 Michigan Boulevard.

The Chorister Phonograph Co., Chicago, Ill., has been incorporated with a capital of \$2,000 by Herbert Green, Ambrose Riddon and William W. Hoover.

NEW OKEH RECORD CATALOG

Very Diversified List Found in New Booklet Which Is Now Being Distributed by Otto Heineman Phonograph Supply Co., New York

In its usual progressive manner, the Otto Heineman Phonograph Supply Co., Inc., 25 West Forty-fifth street, New York, has published a most comprehensive catalog of OkeH Records, including all records issued to June 1, inclusive. The booklet is now being distributed for the use of OkeH jobbers and dealers and one of its features is the diversity of the records listed. The list comprises the very latest dance music, including several Hawaiian selections. Under the caption of "Heart Songs" are found many of the latest ballads. There are also many humorous records by Golden and Heins and Arthur Collins. The instrumental records cover a very wide scope and include classical as well as popular selections. There is also a series of marches and patriotic selections, while the popular songs listed are the very latest published and include a variety of baritone and tenor solos, duets, trios and quartets. One page of the catalog is devoted to sacred selections, while the list of standard songs is of the very highest character.

RENO STORE ADDS BUILDING

J. D. Mariner Makes Plans to Handle Rapidly Growing Business

The new building erected in Reno, Nev., for the J. D. Mariner Music House will be ready August 1, according to the present plans. This house handles everything in the musical line and has an extensive business, both in Nevada and surrounding States. J. D. Mariner says that he is not dependent upon San Francisco for his supplies, as he buys directly from the factories. This concern handles the Mehlin, Ivers & Pond, J. & C. Fischer and other pianos, as well as Edison and Columbia machines.



75c
9 INCH

STOP! LOOK!! LISTEN!!!

Is Your Business Slow?
Give It a Boost

WITH

EMERSON INTERNATIONAL RECORDS

in

Polish=Italian=Hebrew-Jewish=Czecho-Slovak=Russian-Ruthenian=Spanish-Mexican

Special Feature

"INTERNATIONAL" Catalogue

containing wonderfully recorded
Operatic and Instrumental Selections
all at SAME PRICE

THE WORLD'S MUSIC



85c
10 INCH

Prompt Delivery

Popular Price

Foremost Artists

Double Disc

Plays on all
Machines

The Foreigner Buys
BIG
ALL THE TIME
GET HIS
BUSINESS

EMERSON INTERNATIONAL INC.

366 Fifth Avenue, N. Y.

Export Office: 160 Broadway, New York, N. Y.



You don't have to rely on a sample package!

Here is what we guarantee to do.

For a limited time, we will send you an *acquaintance order* so that you can see the "run of the mill."

You can make the order whatever quantity you please and we will give you the benefit of our special acquaintance order price.

This holds good for a limited time only and we are backing it up with our unqualified guarantee that Torrington-ball point **Uniform** needles are superior to the ordinary steel needles in every particular.

The acquaintance order we want to send you will prove definitely that **Uniform** needles are a hundred percent *uniform* in point, *uniform* in length, *uniform* in finish and will produce the most even playing results.

We have proved it to the most critical concerns in the trade, and we can just as surely prove it to you and we urge you to embrace this exceptional opportunity without delay.

You Would

surely be interested to know of the help we have extended to many merchants. It is an interesting subject to every talking machine Retailer. It concerns the vital one of INCREASED PROFITS.

We will be mighty glad to help you, too. It is only necessary for you to write us.

Don't bother to dictate a letter.

One line on your letter head will suffice. Just say, "We are interested in greater needle profits." We will do the rest.

And if we weren't mighty sure that we can produce, we would not be so outspoken.

We guarantee that you will make more money out of a two cent stamp than you ever believed to be possible.

Do not delay but send us that 7 word line today:

"We are interested in greater needle profits."

We guarantee you greater profits in selling needles and we know the suggestions will be worth money to you.

President

Uniform in point — length — finish — and quality

CONDON & CO., INC., *Sole Agents*, Fifth Ave. Bldg., New York

Uniform Needles



That "Jazz Baby" just has to jazz. And so does everyone who hears Agnes Lynn sing it. A-2745.

Columbia Graphophone Co.
NEW YORK

TAKE STOCK IN PLYMOUTH CO.

Stockholders of C. F. Kade Co. Vote to Exchange Stock for Shares in Plymouth Phonograph Co. at Fifty Cents on Dollar

PLYMOUTH, Wis., June 25.—At a meeting of the stockholders of the C. F. Kade Co., of Port Washington, Wis., held in this city last week and presided over by C. F. Kade, president of the company, it was voted unanimously for the stockholders of the Kade Co. to exchange their stock in that company for corresponding stock in the Plymouth Phonograph Co., of this city, on the basis of fifty cents on the dollar. On this basis, two shares in the Kade Co. are to be traded for one share in the Plymouth Co. at a par value of \$100. At the meeting it was stated that the assets of the Kade Co. amounted to \$109,000, or about half the par value of the company's outstanding stock.

AN AD WITH THE PERSONAL TOUCH

A very attractive Columbia ad, and one which is all the more interesting because of the personal touch, recently appeared in the Houston, Tex., papers showing Miss Minnie Seegar, expert saleslady of the Eganhouse Fonograph Shop in that city, demonstrating a Grafonola. This shop is a part of the Eganhouse Optical Co. and carries a good stock of Columbia Grafonolas and records.

"Does It Play All Records?"

Certainly MAGNOLA does; and without any extra attachments, too. This is only one feature, albeit a most important one, in the thoroughly up-to-date equipment of the MARVELOUS MAGNOLA.

MAGNOLA "Built by Tone Specialists"



Watching the Music Come Out

May we send you our handsome illustrated catalog chock full of information concerning the wonderful construction system of Magnola and the beauties of its musical results, its artistic appearance and its moderate price?

Send your name and let us tell you more!

MAGNOLA TALKING MACHINE COMPANY

OTTO SCHULZ, President

General Offices
711 MILWAUKEE AVENUE
CHICAGO

Southern Wholesale Branch
1530 CANDLER BLDG.
ATLANTA, GA.

COLUMBIA CO. BUYS BIG FACTORY

Takes Over the Large Factory Building Adjoining Its Present Plant in Bridgeport, Conn., From the Remington Typewriter Co.

The announcement was made last week of the purchase by the Columbia Graphophone Co. of the big factory adjoining the Columbia plant at Bridgeport, Conn., and owned by the Remington Typewriter Co. The factory building just purchased is on Railroad avenue, and has a considerable frontage on Clinton avenue, extending several hundred feet along the railroad. Part of the property is on the shore of Cedar Creek, and although there is no dockage there now, it is possible this may be developed later, according to officials.

The original factory was built forty years ago for the manufacture of Sharpe rifles. Just what departments of the Columbia Co. will be housed in the new building have not yet been announced, but without question the additional facilities thus provided will prove most welcome in solving the Columbia Co.'s present production problem.

The transaction was said to involve considerably more than a million dollars, the assessed valuation of the plant being \$770,624, of which land and buildings total \$360,000; machinery, equipment and stock, \$417,263, and other property, \$361, according to the City Hall records. The Remington Typewriter plant employs in the neighborhood of four hundred hands.

NEW BONUS FOR EDISON EMPLOYEES

ORANGE, N. J., June 21.—At the annual field day of the Edison employes recently held at Olympic Park, Irvington, it was announced by Charles Edison that a new bonus system would go into effect on July 1. The object of the new bonus system is to reduce wastage and it will apply to 7,000 employes.

NEW YORK FIRM CHANGES NAME

The Reliable Purchasing Co., Irving Lasky, proprietor, which conducts a wholesale business in talking machines, records and accessories, 133 Mercer street, New York, has announced that the name of this concern has been changed to the Interstate Purchasing Co.

The Columbia Music Co., Inc., Lynchburg, Va., has opened a new store at 615 Main street. G. W. Legg is in charge.

SCORES SUCCESS ON THE STAGE

Sonora Portable Figuring in a "Star" Capacity on the Stage These Days

A new musical show entitled "Come Along," which will soon begin a tour of the country and which is based on an American soldier's experience on the other side, includes a Sonora Portable in the stage setting in the second act. Six beautiful ladies sing a song about some gentleman who played the Sonora, and then to make the scene complete the six young ladies later appear, each carrying a Sonora Portable.

The Sonora Portable phonograph also appeared on the stage when the Lambs Gambol



Sonora Portable in Good Company

housed in the new building have not yet Farrell Case," by George M. Cohan, the stage setting consisted of a simply furnished room, a desk, chair, telephone and on a small stand a Sonora Portable. During the farcical sketch practically all of the actors were killed off, and the last one, trying to reach the window and shout for help, falls over, turns on the Sonora Portable and expires to its lovely strains. The playing of the Sonora Portable under such ludicrous circumstances was received with howls of joy by the audience, and through the door ever-famous George M. Cohan, accompanied by his own American flag, rushed in and took the applause which some say rightly belonged to the Sonora Portable phonograph.

MADE DIRECTORS OF EMERSON CO.

Lewis B. Hall, Jr., of James B. Colgate & Co., 36 Wall street, New York, and Jacob Scholer, of the law firm of Kaye, MacDavitt & Scholer, 149 Broadway, New York, have been elected directors of Emerson Phonograph Co.

WESTERN VENEER PRODUCTS CO.
3900 CHOUTEAU AVENUE, ST. LOUIS, MO.

Largest Manufacturers of 3-ply Waterproof Veneer Phonograph Shipping Cases

Ask for Prices and Samples



"Last night, the Nightingale woke me,
Last night, when all was still;
It sang in the golden moonlight — "

—KJERULF



The Phonograph Dealer who will make the money this season is the man who has the *right* instrument on his floor—and who has the knack of seeing its beauty and hearing its melody through the eyes and ears of his best customers.

The secret of this invaluable knack is released to you in the new and beautiful *Nightingale Book*.

You can get just a faint idea of it from this proof of the front cover. It is like no other phonograph book in the world.

★ ★ ★

Success has entered more than one life through the reading of a single book.

Reach *now* for your letter-head, and say to the *Nightingale Manufacturing Company*, at 422 *Armour Street*, *Chicago*, just four words—

“Send the Nightingale Book!”



*The
Nightingale*



Stoddard King Zo Elliott

A single line of musical notation in treble clef, featuring a key signature of two flats (B-flat and E-flat) and a common time signature (C). The melody consists of a series of notes, some of which are highlighted in a light blue color, corresponding to the lyrics below.

“There’s a long, long trail a-winding,
Into the land of my dreams —
Where the Nightingale is singing
And the white moon beams — —”

—“There’s a Long, Long Trail”

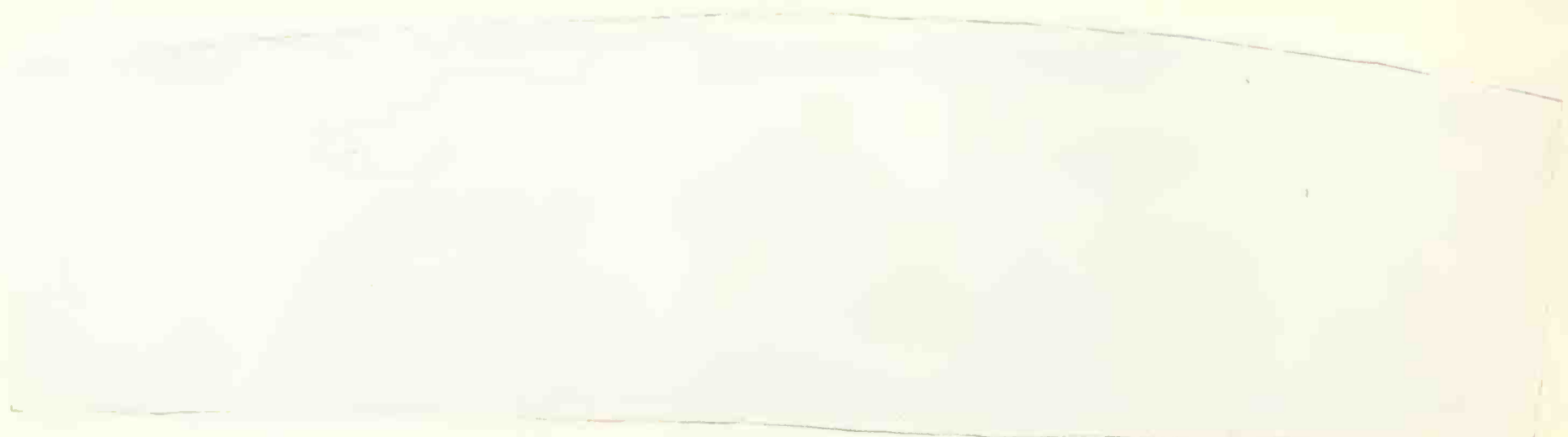

LYONS FAIR TO BE HELD IN FALL

Musical Instruments Will be Exhibited in Fall Session, October 1-15—Official Representative Sent to New York—To be Held Twice a Year

The Lyons Fair has been so successful that the authorities in France have determined to continue it, running two exhibitions each year, one October 1-15 and the other March 1-15.

According to this plan the Fair will be divided into trade sections, each section being open to exhibitors only once a year, i. e., at one of the dates mentioned above, the plan being to group the sections at each fair in such a way as to prevent buyers of similar articles from having to visit the Fair twice in the same year.

The Fair does not consist of windows and showcases, but of real shops and offices, independent of each other, where each manufacturer may feel absolutely at home.

Entries should be sent before December 31 for the Spring Fair, and July 31 for the Autumn Fair. In the case of shipments from the United States, all samples, catalogs and exhibits must be in the hands of the American Express Co. within two weeks following the above-mentioned dates; that is, for the Fall Fair samples and exhibits must be in the hands of the American Express Co. on or before August 15. After these dates entries may be accepted, but the position of the stalls in their respective trade divisions cannot be guaranteed.

Musical instruments are listed under section 29 and are scheduled for exhibition at the Autumn Fair.

The Lyons Fair has recently sent to New York, as its official representative, Ernest Perrin, who has opened an office at No. 3 Park Row.

CHANGE IN EMERSON RECORD SIZES

June "Emersonian" Contains Much of Interest in This Connection—House Organ Praised

The second issue of the "Emersonian," which appeared last month, contains many helpful comments on handling the Emerson business, and is also full of interesting sidelights on Emerson recording. Perhaps the most interesting news to the trade to be found within its covers is the announcement of an important change in Emerson record sizes. All popular song hits of the day, it announces, will be recorded as heretofore on Emerson Gold Seal nine-inch records only. Dance, band, and standard instrumental music will be recorded on Emerson Gold Seal ten-inch records. All religious, standard and semi-classical music will be recorded on Emerson Gold Seal ten-inch records. International Emerson label records of songs, melodies, instrumental, semi-classical and operatic music will be recorded on nine-inch records. The Emerson Co. believes that by adopting this policy it caters to the demands and wishes of the public.

INSTALLING NEW BOOTHS

Brunswick Bros., distributors for the Brunswick in Pittsfield, Ill., are installing new sound-proof booths in their building. A large stock of records is carried, among them being Victor, Columbia, OkeH and Pathé. An attractive display is being made.

Special on STEEL NEEDLES

We are contemplating closing a contract for **Thirty Million Needles** Per Month within the near future, and must arrange to sell them, and can quote prices as follows:

10 thousand lots	45c per thousand
100 thousand lots	43c per thousand
500 thousand lots	42c per thousand
1 million lots	39c per thousand
5 million lots	33c per thousand

LUCKY "13" PHONOGRAPH CO.
46 East 12th Street, New York

CHARGED WITH UNFAIR PRACTICES

Complaint Served on Boston Piano & Music Co. By the Federal Trade Commission

WASHINGTON, D. C., June 23.—The Federal Trade Commission has served formal complaint of unfair competition against the Boston Piano & Music Co., Iowa City, Ia., and the defendant is cited to make answer before the Commission in Washington on July 21. The charge alleges fraudulent schemes and practices, and false representation in the interstate sale of talking machines and records known as "Masterphone" machines and records. It is charged that salesmen for the concern assured prospective purchasers that dealers were abandoning the sale of various standard makes of machines in favor of their product, and made other promises of exclusive selling rights and sales and advertising support which were not forthcoming.

Every dealer should keep up the campaign for music in his locality.

NEW EDISON STORE IN WICHITA

Phonograph Department of Innes Dry Goods Co. to Be Conducted as Separate Concern Under the Name of Innes & Cosgrove

WICHITA, KAN., June 16.—The Edison phonograph department of the Innes Dry Goods Co. store is being separated from the department store proper and hereafter will be conducted as a separate concern under the firm name of Innes & Cosgrove.

Claude W. Cosgrove, manager of the Edison department at the Innes store, will be manager of the new concern, which will be located at 407 East Douglas street. The new concern has taken out a charter and is capitalized at \$20,000.

TO ADD TALKING MACHINES

A large stock of talking machines has been added to the line of the Bruce Piano Co., Springfield, Ill. Plans are under way for improvements to the present quarters on Monroe street.

**FAULTLESS
PIVOT BEARING
CASTERS**

Casters that roll easily across the floor—and smoothly. No chatter—no unsteadiness.

Simple construction—no complicated parts to get out of order, nothing to retard easy movement. Strong—plenty of metal in required places to resist strains.

Silent—neat appearing—a real necessity to YOUR talking machine, these FAULTLESS CASTERS.



Full Size—C-65

Made with leather, fibre, felt, steel and lignum-vitae wheels. A word from you puts all our caster experience at your service and brings you a copy of Faultless Catalog "G".

**FAULTLESS
CASTER COMPANY**
EVANSVILLE, INDIANA

"Move the FAULTLESS Way"

Eastern Sales Office:
Geo. Mittleman, 487 Broadway, N. Y.



“THE ARTIST”

Appeals to Every Dealer Who Thinks

Because of its—

**Tonal Supremacy
Cabinet Excellence**

**Mechanical Perfection
Great Value**

**Certain Deliveries
Liberal Discounts**

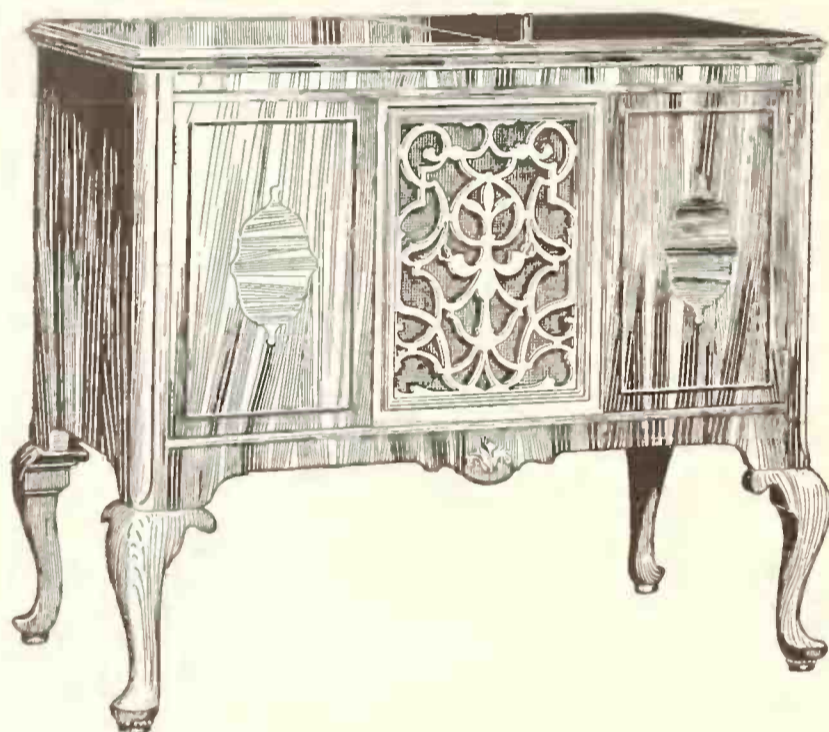

It is a fact, because of L'Artiste-Fletcher reproducer in conjunction with the very exceptional L'Artiste tone arm and the greatly improved construction of L'Artiste all-wood horn, that L'Artiste reproduction is of unusual quality, ample volume, with far less surface noise than usual.

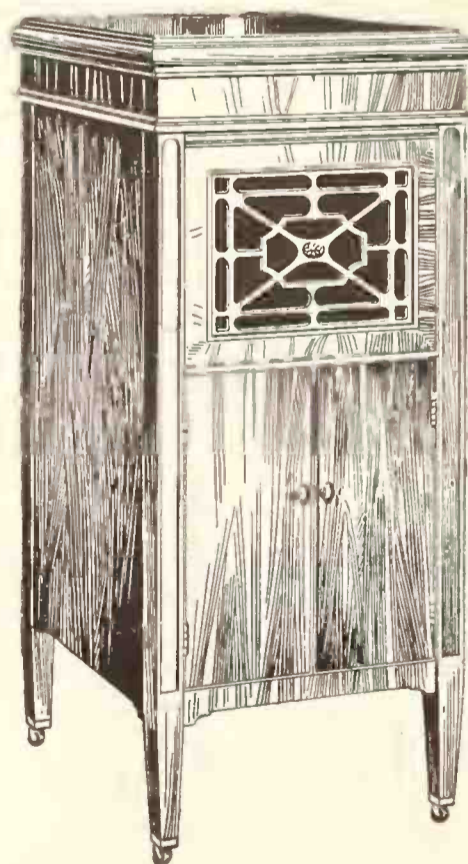

**YOUR CATALOG
IS READY**

Shipments in August

Five Upright Cases
\$100, \$125, \$150, \$175, \$250

Four Console Tables
\$150, \$200, \$250, \$300

GRAND RAPIDS PHONOGRAPH COMPANY

Fourteen hundred Block Front Ave., N. W.

Grand Rapids, Mich.

NEW PLYWOOD OF UNUSUAL MERITS

Wartime Product of Haskelite Mfg. Corp. Now Available to Trade—Albumin Glue Used

A new plywood manufactured under the name of Haskelite, which is produced by the Haskelite Mfg. Corp., whose executive offices are located at the Chamber of Commerce Building, Chicago, has many unusual features that should interest talking machine manufacturers. Instead of using the ordinary glue an albumin glue is used, which is set and hardened under a combination of pressure and heat. Due to the fact that a glue of this sort is used, further heating, soaking or steaming does not affect the glue to any noticeable effect other than that it sets more firmly. When a plywood is made up with this patent glue a paneling is obtained which has a minimum warp, and which is impervious to water, and will not warp when subject to heat. Because of the elasticity of the binding material, Haskelite can be bent at right angles without cracking, splitting, or in any other way affecting the exterior surface. Haskelite was a wartime invention and as a new product the Government did not allow the manufacturers to give publicity to their product during the war, as it was believed information about it might be of value to our enemies. Haskelite, as the plywood is called, is made up to practically any thickness, and in sizes to meet the demands of the individual. The variety of uses to which Haskelite may be put can be judged from the fact that to-day it is employed in the manufacture of the hulls of submarine chasers, the tops of automobiles, and the panels of art cabinets. In the latter a gum wood exterior is used, which, when finished, shows the unusual grain and obtains a high polish.

VICTOR CO.'S LATEST DIVIDEND

The Victor Talking Machine Co. has declared a regular quarterly dividend of 5 per cent. and an extra dividend of 15 per cent. on the common stock and the regular quarterly dividend of 1 3/4 per cent. on the preferred stock of the company, payable July 15 to stockholders of record June 30.

COLUMBIA CO. SIGNS YERKES' BAND

The Columbia Graphophone Co. has just made a contract with Harry A. Yerkes, of Yerkes' Novelty Orchestra, for the exclusive right to record the work of the saxophone sextet with the understanding that the organization shall be known as the Columbia Saxophone Sextette.

Take Advantage
of the
Summer Months

Suggest to your customers how they may return from their vacations at the mountains or seashore with the accomplishment of another language acquired, at the same time providing excellent pastime for the long summer evenings.

Sell them the

CORTINA
Phone-Method

It means profits on records, machines and text books.

Send for full information. Advertising matter and window displays.

The Cortina Academy
12 East 46th Street :: New York

BUYS OUT SCHIRMER DEPARTMENT

H. W. Hess Assumes Control of Talking Machine Department of G. Schirmer, Inc.

H. W. Hess, formerly of Tilden-Thurber, Providence, R. I., who last September took charge of the talking machine department of G. Schirmer, Inc., New York City, last Tuesday purchased this talking machine department from the Schirmer Co. Since the business was originally placed under Mr. Hess' management it has increased considerably. The business in the future will be conducted under the name of the Central Talking Machine Sales Co., Inc., but as far as the public is concerned all publicity, etc., will continue to be conducted and all retail business done under the name of Schirmer.

FRIDAY, THE THIRTEENTH, UNLUCKY

The Jinx Lures Piano and Talking Machine From Freight Car in Chicago Yards—The Judge Next Morning Proves Unsympathetic

We thought our luck on Friday, the 13th, was too good to be true. We knew that somewhere in this busy country the jinx just naturally had to pick on someone, and we have found out that the scene of the misfortune was in the New York Central yards in Chicago. On the afternoon of the fateful day a freight car entered the yards and was shunted to a side track. Within this car were a piano and a talking machine. The doors of the car were locked and sealed. An hour after the car came to rest the jinx descended and transported the instruments to the home of Lily Wallace, a negress, at 4130 Forestville avenue. Not long afterward two negroes greeted the gentleman at the bench with the usual "Good morning, Judge" and gave their explanation. The men were Henry Gest, sometime native of Florida, and Burt Burton, who rooms at the Wallace house.

"Boss, we ain't lugged nothing nowhere," replied Gest. "The things just followed us. We couldn't keep 'em from doin' it. And we was trying to coax 'em back to that freight car when we was arrested."

The negroes were held for freight car theft.

SALES REGISTER BOOK

Little Volume to Be Issued by New York Talking Machine Co. Will Greatly Interest Trade

A Sales Register Book to keep an accurate accounting system of the talking machine business by an individual concern is to be issued by the New York Talking Machine Co. This book will be gotten up in a loose-leaf binder style so that it is perpetually up to date. The book will contain a practical and modern system of registry: the purchase of talking machines, the models of the machines purchased, the date of purchase and the name of the jobber from whom they were obtained. It will also contain pages for the sale of machines, showing to whom the sale was made, the style of machine and the day of sale. It is believed that a book of this sort will greatly facilitate the dealer in keeping records of his purchases and sales.

F. R. SMITH IS PROMOTED

Former Head Bookkeeper in New York Made Assistant Manager of Boston Branch of Columbia Graphophone Co.

F. R. Smith, until recently head bookkeeper of the New York retail branch of the Columbia Graphophone Co., has been appointed assistant manager of the Boston branch of the Columbia Co. He will replace M. C. Perkins, who has resigned to take up the management of the Perkins Music Co., Malden, Mass. Mr. Perkins plans a vigorous effort in behalf of his new business, as he feels there is a splendid field in the territory in which he will operate. His store will handle the Columbia line exclusively.

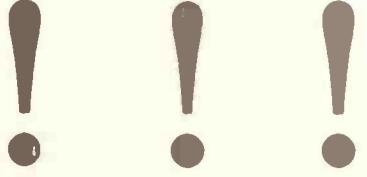

The
DEMAND
for
PHONO-GRAND
is
S-P-R-E-A-D-I-N-G
over all the land
The Reason
Phono-Grand

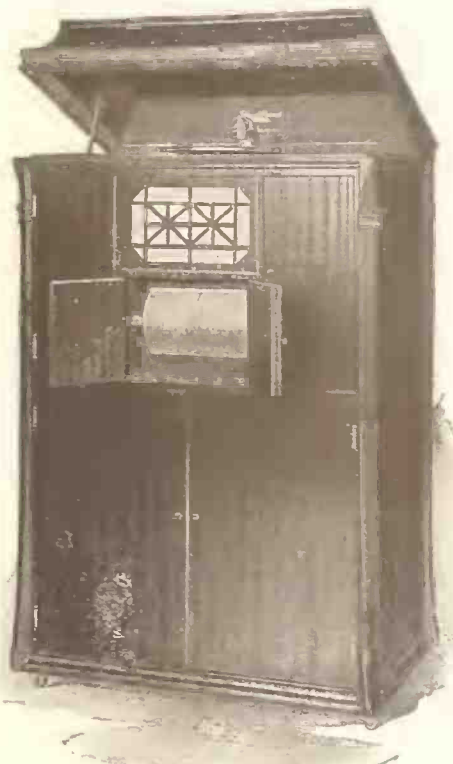

Dealers are Making Big Money
in all parts of the country selling this wonderful little instrument

Phono-Grand is an *Edition de Luxe Phonograph* and a *Splendid Reproducing Electric-Controlled Player Piano*

ALL IN ONE
"IT'S ALL VELVET!"

Write us today and we'll tell you why

J. P. Seeburg Piano Co.
209 S. State St. Chicago, Ill.
419 W. Erie St.

Get in touch with the jobber who operates in your territory

1—Sonora Phonograph Co.

616 MISSION ST.
SAN FRANCISCO, CAL.
Washington, California, Oregon,
Arizona, Nevada, Hawaiian Islands,
Northern Idaho.

2—Strevell-Paterson Hardware Co.

SALT LAKE CITY, UTAH
Entire States of Utah, Colorado,
Wyoming, New Mexico and Southern
Idaho.

3—Minneapolis Drug Co.

MINNEAPOLIS, MINN.
States of Montana, North Dakota,
South Dakota, Minnesota.

4—C. D. Smith Drug Co.

ST. JOSEPH, MO.
Nebraska, Missouri, northern and
eastern part of Kansas and 5 coun-
ties of Northeastern Oklahoma.

5—Walthall Music Co.

DALLAS, TEXAS
Western part of Texas.

6—Southwestern Drug Co.

WICHITA, KANS.
Southern part of Kansas, Oklahoma
(except 5 northeastern counties), and
Texas Panhandle.

7—Southern Drug Co.

HOUSTON, TEXAS
Southeastern part of Texas.

8—Yahr & Lange Drug Co.

MILWAUKEE, WIS.
Wisconsin, Upper Michigan.

9—C. J. Van Houten & Zoon

MARQUETTE BLD'G.
CHICAGO, ILL.
Illinois, Kentucky and Iowa.

10—Kiefer-Stewart Co.

INDIANAPOLIS, IND.
Entire State of Indiana.

11—Ohio Sales Co.

BECKMAN BLDG.
409 SUPERIOR ST
CLEVELAND, OHIO
State of Ohio.

12—Hessig-Ellis Drug Co.

MEMPHIS, TENN.
Arkansas, Louisiana, Tennessee,
Mississippi.

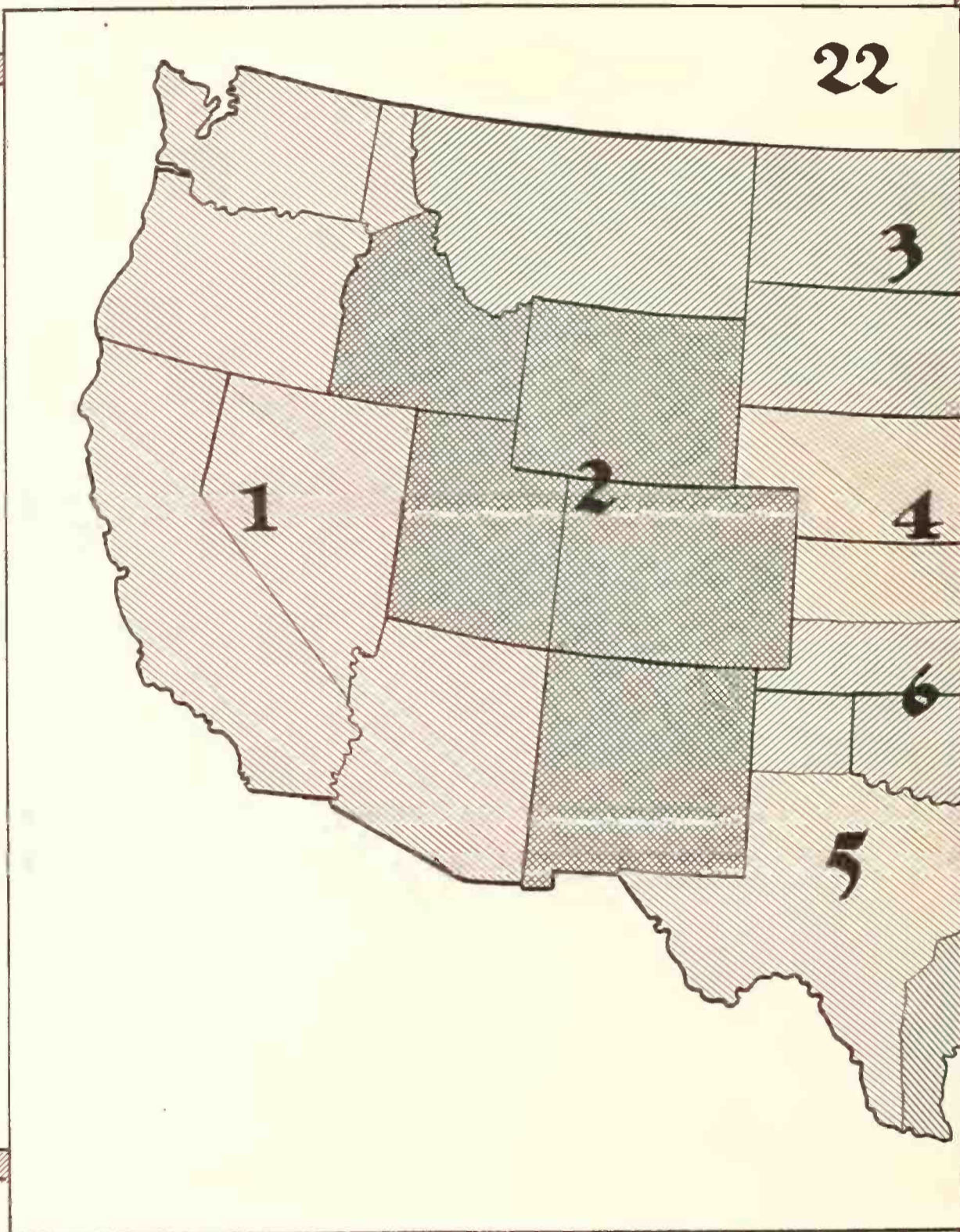

The Highest Class
Talking Machine
in the World



A complete line of upright and period models is available at prices from \$50 to \$1000
The Sonora is the instrument which won the highest score for tone quality at the Panama-Pacific International
Exposition and sells easily and for cash.

These firms will see to it that you get the best of service

22

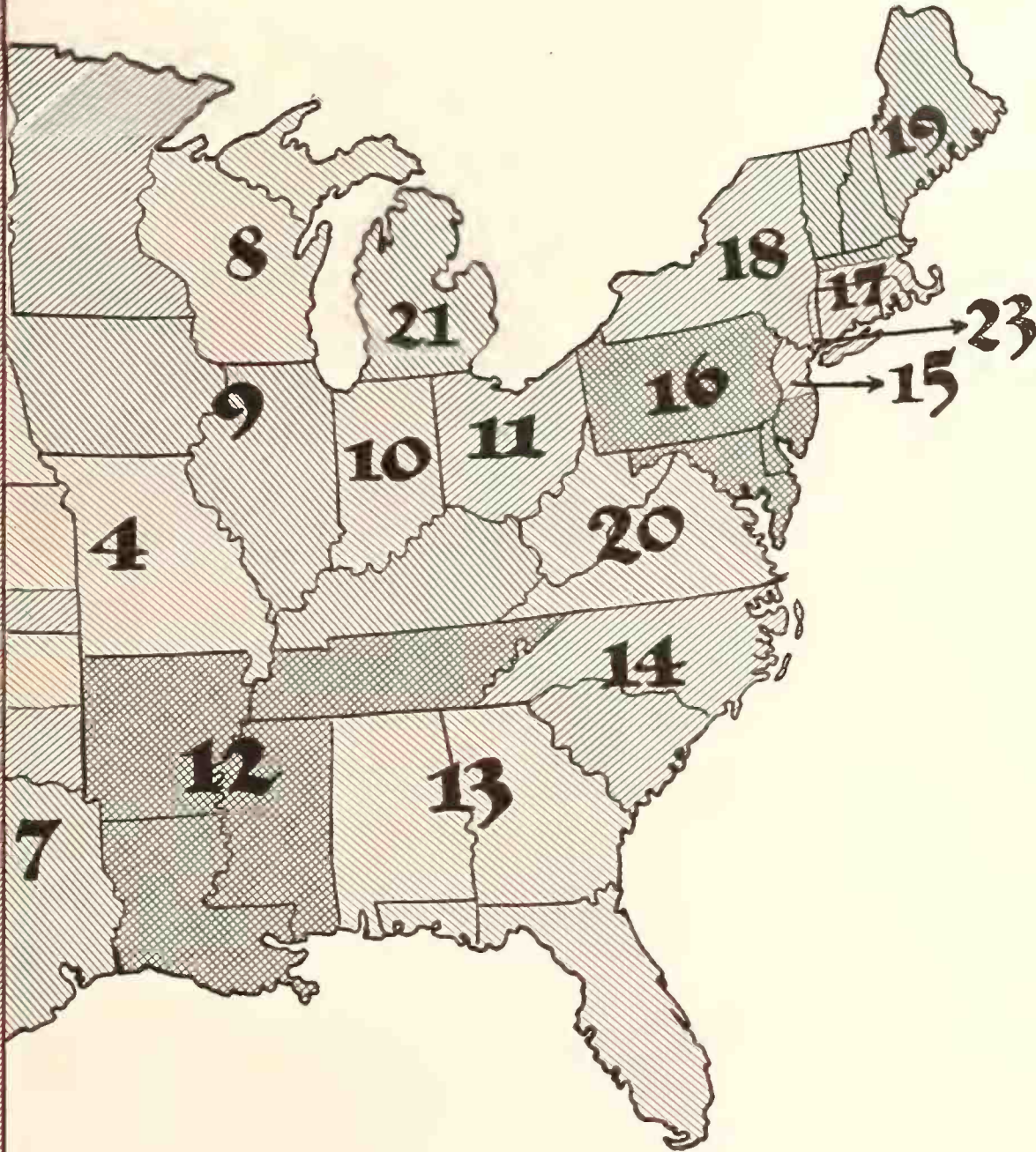

13—Southern Sonora Phonograph Co.

SELMA, ALA.

Alabama, Georgia and Florida.

14—Rountree Corporation RICHMOND, VA.

North Carolina and South Carolina.

15—Griffith Piano Co.

605 BROAD ST., NEWARK, N. J.

Northern New Jersey.

16—Smith, Kline & French Co.

PHILADELPHIA, PA.

State of Pennsylvania, Maryland, Delaware, District of Columbia and New Jersey, south of and including Trenton.

17—Musical Supply & Equipment Co.

221 COLUMBUS AVE.

BOSTON, MASS.

Connecticut, Rhode Island and Eastern Massachusetts.

18—Gibson-Snow Co.

SYRACUSE, N. Y.

State of New York with the exception of towns on Hudson River below Poughkeepsie and excepting Greater New York.

19—W. B. Glynn Distributing Co.

SAXTONS RIVER, VT.

States of Maine, New Hampshire, Vermont and part of Massachusetts.

20—Hillman & Son Phonograph Co.

WHEELING, W. VA.

Virginia and West Virginia.

21—C. L. Marshall & Co.

82-84 GRISWOLD ST.

BUTLER BLDG.

DETROIT, MICH.

State of Michigan.

22—I. Montagnes & Co.

RYRIE BLDG.

TORONTO, CANADA.

Canada

23—Sonora Phonograph Sales Co., Inc.

279 BROADWAY, NEW YORK

Distributors for Greater New York.

THE INSTRUMENT OF QUALITY

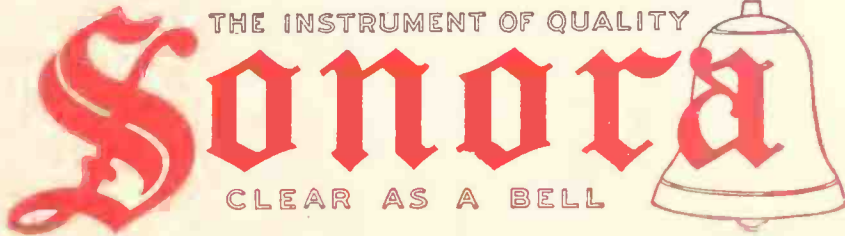

Semi-Permanent Silvered NEEDLES

replace steel needles and increase your phonograph records' life They play 50 to 100 times, are used on ALL MAKES of steel needle records, are more economical, convenient and give the maximum of satisfaction. 30c per card of 5—40c in Canada



**“Tears (of Love)” and “Yama Yama Blues”
on the same record will dry anyone’s tears,
drive away any blues. A-2741.**

**Columbia Graphophone Co.
NEW YORK**

COLUMBIA NOVELTY RECORD BOOK

New Booklet Featuring Green Label Records
One of the Handsomest of Its Kind—Con-
tains Interesting Facts for All Buyers

One of the most impressive booklets among the many in the record field is the latest publication of the Columbia Co. called the “Novelty Record Booklet.” This booklet is handsomely and artistically arranged and contains many features that will attract and hold the attention of its readers. The front cover design is beautifully lithographed in colors and suggests one of the big advertising values of the novelty record scheme, featuring the new green label which has been adopted as the symbol of these records. The inside cover displays the green label itself. As for the pages of the booklet, each is devoted to the particular records of some foreign country, such as Spain, China, Japan, Serbia, Italy, Bohemia, Russia, Belgium, Holland, Turkey, Sweden and others, and contains a sketch concerning the music of that people which makes interesting and instructive reading. Around the borders of each page are little thumb-nail illustrations in soft tints of red, gray and green, accurately portraying the costumes, instruments and customs of the country the music of which is listed on the page.

The foreword explains the purpose and origin of this unique collection of records which has been produced in response to the belief that the music of the Far East is worthy of more

NEW SONORA BILLBOARD AT CONEY ISLAND ATTRACTS

A new and novel sign, which is as visible at night as by day, has recently been erected by the Sonora Phonograph Sales Co., Inc., near Coney Island. Its location is such that it can

Sonora. It makes the name stand out more prominently than the rest of the display. The visibility and advertising power of this sign can be seen from the illustration on this page.

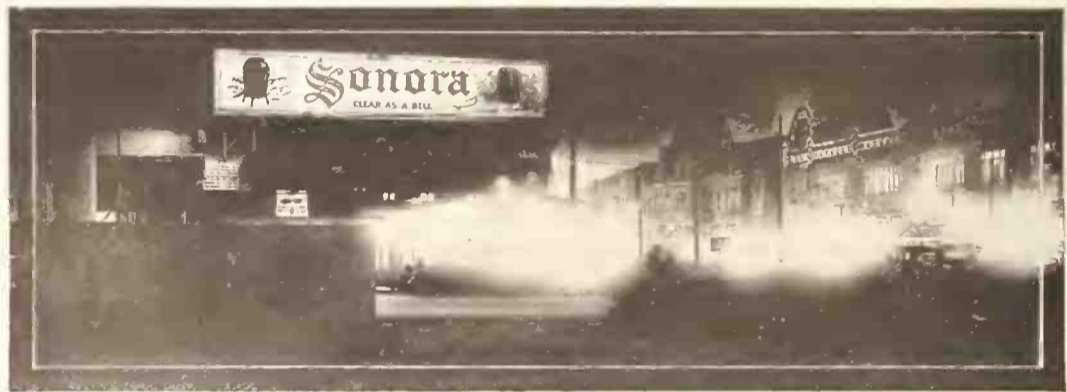

This Sign is Seen for Miles by Visitors to Noted Resort

be seen for miles when approaching Coney Island. The sign is illumined by night by large and powerful lamps played directly on it, and by a battery of bulbs placed behind the word

This sign must unquestionable leave a strong impression on the thousands who throng Coney Island these days and nights and is a good example of artistic advertising.

than passing interest and that the beauty of the melodies lies not so much in their strangeness but in their natural harmonies. Each type of music has been reproduced for the records by the instruments used by the native peoples and thus a faithful portrayal has been obtained.

This new novelty collection of records is expected to have a phenomenal sale among rec-

ord buyers and with this in mind the Columbia Co. is planning an extensive campaign to be carried on all over the country.

FOUND BIG WESTERN BUSINESS

John Cromelin, General Sales Manager of the Otto Heineman Phonograph Supply Co., Inc., Returns From Interesting Trip

John Cromelin, general sales manager of the Otto Heineman Phonograph Supply Co., Inc., returned to New York a few days ago, after visiting the trade in Grand Rapids and Chicago. In Grand Rapids Mr. Cromelin found the principal OkeH jobber, Chas. Kalder, most enthusiastic regarding the progress and success that he is making with the OkeH records. Mr. Kalder has completed arrangements to increase his sales force materially and additional salesmen are now visiting the dealers in his territory. They are co-operating with the dealers in every possible way and an extensive advertising campaign has been inaugurated.

In Chicago Mr. Cromelin visited the various OkeH jobbers and was pleased to find that the OkeH record is gaining steadily in popularity throughout the Middle West. The new bulletins are meeting with a hearty reception and the jobbers expressed their pleasure regarding the splendid tone quality of the OkeH record.

While visiting the Chicago trade Mr. Cromelin took advantage of the opportunity to call upon a large number of the “independent” phonograph manufacturers in this section, and found conditions phenomenal. Practically all manufacturers are far oversold and the principal problem confronting them at the present time is a question of product and not one of merchandising. From all indications, this year will be the greatest in the history of the phonograph industry and in fact the majority of manufacturers are already making plans for 1920 activities.

**1919 Will Be A
Banner Phonograph Year**

Prepare Now To Give

YOUR CUSTOMERS THE BEST POSSIBLE

By Getting

Pathe Phonographs and Pathe Records

Through

The Fischer Company

(Oldest Pathe Jobbers)

940 Chestnut Avenue

Cleveland, O.

Announcement

I HAVE assumed control of the Record Needle & Mfg. Co., and am reorganizing the business to assure the Record-Lite and Record Needle Cutter of their rightful prominence in the talking machine trade.

Increased and improved equipment and renovated factory methods insure that every piece of goods we turn out will be *right* in every detail. I guarantee this.

A new marketing plan insures absolutely fresh batteries—no deterioration—no battery stock in jobbers' warehouses.

Consistent advertising and energetic sales methods will characterize the business.

Record-Lite and Record Needle Cutter are destined now to become two of the liveliest selling specialties in the talking machine field.

I urge Jobbers and Dealers to take steps *now* to supply the trade.

Record Needle & Mfg. Co.
Milwaukee, Wis.

R. N. Zinke
President

President Milwaukee Association of Music Industries.

President Wisconsin Association of Music Industries.



Universal Record-Lite
Both Universal and Victrola Record Lites completely remodeled — better materials, better nickel and gold plating. Absolutely guaranteed in every respect.

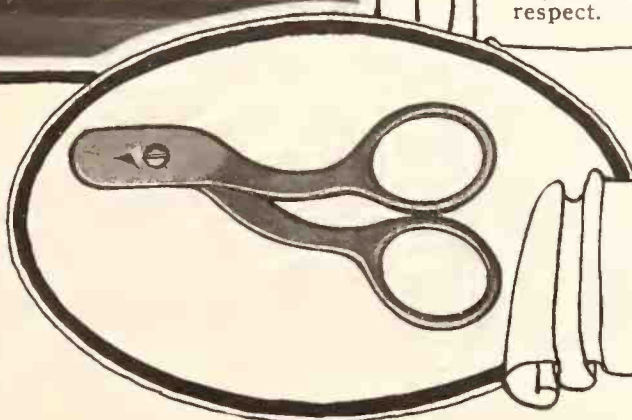

Record Needle Cutter
Perfected workmanship, better materials and fitting all through. Blades specially heat treated, hardened, ground and sharpened. Last indefinitely. Each cutter guaranteed.



IMPORTANCE OF BRANCH OFFICES

Recent Experience in Heineman Canadian Headquarters Shows Value of Fireproof Construction—Well-appointed Departments in Chicago and San Francisco Also Maintained

Had it not been for the fact that the office of the Canadian division of the Otto Heineman



Canadian Office, Toronto, Ont.

Phonograph Supply Co., Inc., is of absolutely fireproof construction, and that the receptacles for wastepaper and the like are of metal, a serious fire would have occurred recently. When C. J. Pott, manager of the division, entered his office on a recent Monday morning he found



Shipping Department, Chicago Office

the place full of smoke, and upon investigation he discovered that sometime between Saturday and Monday spontaneous combustion had taken place in some oil-soaked waste that had been used in the workshop. The waste set fire to a work bench, but the fire burned no further, owing to the fact that there was nothing but fireproof material around it. The stock in the

warerooms was untouched. In one of the accompanying illustrations a view of the office may be seen.

The other two reproductions are of the shipping department in the Chicago office showing the painstaking methods pursued in facilitating Heineman service, while the other shows a corner in the office of the San Francisco branch. Standing to the left of the table is Manager L. Gruen, discussing in detail the important features of the motor held in the hand of one of his assistants.

The maintaining of these offices shows forcefully the thorough manner in which the Otto

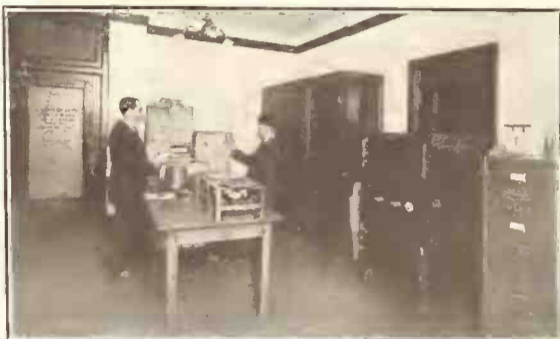

Corner in San Francisco Office

Heineman Phonograph Supply Co., Inc., has the country covered from coast to coast so that jobbers and dealers handling Heineman products will at all times have the benefit of a branch office within a certain radius, as well as the home office in New York.

OPENS IN NEW LOCATION

The Phonograph Shop, North Adams, Mass., has opened in its new quarters at 24 Bank street. This concern will handle Edison and Steger machines and records. The shop is under the management of Walter Timoney, who has had much experience in talking machine work.

George E. Buss, Edison dealer of New Philadelphia, Ohio, has leased new quarters and will move in as soon as alterations are completed.

PRECISION CASTINGS CO. ENLARGES

E. N. Dallin Tells of Improvements to New Syracuse Plant—Finds a Gradual Trend Toward Aluminum Castings at Present

SYRACUSE, N. Y., July 5.—A representative of The World in a chat with E. N. Dallin, of the Precision Castings Co., Inc., of this city, gleaned the following interesting information: "We are making large additions to our plant and increasing our equipment. When we are finished we will have one of the finest die casting plants in existence, although, of course, not the largest. We are doing a great deal of talking machine work, but are limiting ourselves to quantity production orders, as the character of our equipment is such that small orders cannot be economically run. We find a gradual trend towards aluminum castings and recently have booked large orders for some of the most difficult work in this line.

"We have also recently found that our factory locations in Fayetteville, N. Y., and Pontiac, Mich., are such that we are not subject to interference from the radical labor elements. Our employes are well paid and satisfied, and as far as we can see ahead will continue to remain so. The indications for business are encouraging and if they are realized our capacity will be far too small to satisfy the demand."

NEW UNICO BOOTHS INSTALLED

The Petersburg Music House, Petersburg, Va., has just added six new demonstration booths made by the Unit Construction Co., of Philadelphia. J. K. Fletcher, manager of the concern, is seeking a new location for his business and when located in the new quarters expects to have at least fifteen demonstration booths.

The Pathé Music Store, Alma, Mich., owned and managed by Frank F. Smith, has moved into new quarters on East Superior street, in the building directly opposite the store formerly occupied by this concern.



Exclusive Tone-Arms That Harmonize With Any Style Cabinet

IS THE tone-arm of your machine featured in your advertising as one of the distinguishing marks of the superiority of your product?

"Indiana" Die Casting Company experts will gladly confer with you on the design of an individual, exclusive tone-arm that will be in accord with the style of your cabinet.

The possession of your own dies will cut the costs, insure individuality, and guarantee deliveries, no matter how rapidly your production increases.

This service incurs no obligations on your part.

Send for the "Indiana" Booklet

"INDIANA"
DIE-CASTING CO.
INDIANAPOLIS, U.S.A.

New York Office: Vitus F. Di Lustro, 1003 Tribune Bldg.

*We received a letter
the other day from
a dealer handling*



OKEH

RECORDS

The letter said:

"I am selling two lines of phonographs that play the OkeH Records and you know, of course, that I am keenly interested in the sale of this record. Another reason is because the music is superior to all other makes, to my way of thinking, and I have handled and demonstrated all makes in all sizes from the smallest records to the largest that are made.

"The instruments that I handle seem to bring the music out of OkeH records wonderfully and I am proud, indeed, to handle these records."

(Name on Request)

We offer the trade a

Quality Record

plus

Immediate Deliveries

of all the

Popular Hits

The OkeH proposition gives liberal discounts to the dealer. Write for details.

Otto Heineman Phonograph Supply Co., Inc.

25 West 45th Street

New York City, N. Y.

FACTORIES: ELYRIA, O.—NEWARK, N. J.
PUTNAM, CONN. SPRINGFIELD, MASS.

Branch Offices: Chicago, Ill. San Francisco, Cal. Toronto, Can.



REPRODUCER MADE OF GAS MASK

Unusual and Interesting Souvenir Brought Back From France by M. C. Schoenly, Former Member of Victor Co. Traveling Staff

CAMDEN, N. J., June 30.—One of the most unique and interesting souvenirs of the great war has been brought back from France by M. C. Schoenly, of the traveling department of the Victor Talking Machine Co., who as a member of the 101st Engineers of the Twenty-sixth Division served eighteen months in France. The souvenir is nothing less than a most acceptable reproducer, fashioned out of a gas mask taken from a captured German, and used on a Victrola VIII, which had been donated to Company D of the 101st Engineers by Kraft, Bates & Spencer, the Victor dealers of



M. C. Schoenly

Boston, Harry L. Spencer being first lieutenant in the company.

After having passed through many battles unharmed the Victrola disappeared mysteriously in July, 1918, and reappeared two months later just as mysteriously, and with the reproducer missing. It was then that the German gas mask was utilized. The mica in the eye holes was made into a diaphragm, a piece of brass tubing from an exploded shell was used as a needle holder and the round rim holding the rubberized cloth and the metal breathing tube in place was also utilized, with the result that a very acceptable reproducer was fashioned. It is true that it did not bring out all the beau-

ties of the records, but it met the emergency to the satisfaction of the soldiers.

The reproducer was literally hammered together, no solder being available, and the needle holder was held in place by a piece of string.



Sound Box From Gas Mask

Reproducing needles were fashioned from ordinary sewing needles, taken from the soldiers' kits. The reproducer proved a never-ending source of interest to soldiers and natives alike.

Mr. Schoenly, who brought the sound box back from France, was a member of the Victor traveling staff before enlisting as private in the First Massachusetts Engineers in June, 1917. He left for France on September 26, 1917, and during his eighteen months of foreign service was never absent from his company. His good service is testified to by the fact that he came home wearing a sergeant's stripes.

MAKES HIT IN PORTLAND PARADE

Wakefield Music Co. Has Attractive Float in the Victory Rose Festival Parade

PORTLAND, ORE., July 4.—The only music house taking part in the Industrial parade during the recent Rose Festival was the Wakefield Music Co., whose float was one of the most talked of and most admired. On the float was a "Cremona," the new phonograph which Mr. Wakefield has just completed and put on the market, which played dance music, while on the float three handsome couples danced to the music furnished as the procession moved through the streets. The young ladies were charmingly gowned and with their partners made an attractive and graceful picture. As the tens of thousands of spectators viewed the parade, the float was a big advertisement for the "Cremona." The whole idea was novel and the new instrument was advertised in a manner that caught on with the crowd.

TALKING PICTURES NOW POSSIBLE

Latest Inventions in Radio Transmission Make Possible Singing and Talking Pictures—Talking Machine Synchronized

According to Mr. Godfrey Isaacs, managing director of the Marconi Co., the latest inventions in wireless transmission have made talking and singing pictures possible.

The cinema articulate opens up immeasurable possibilities in the world of popular entertainment and of educational science. Almost since the invention of the moving picture attempts have been made to introduce a method that would give the effect of making the characters talk. All these efforts were comparative failures. The nearest measure of success was achieved by the gramophone, but great difficulty was experienced in making the talking machine and the pictures synchronize.

For the secret of the new invention—well kept up to now—we have to turn to the greatest hidden force of modern science—wireless telegraphy.

Mr. Godfrey Isaacs, managing director of the Marconi Wireless Telegraph Co., states that the invention has reached the stage of commercial enterprise.

"There is no doubt whatever about its capacity to reproduce all sounds," says Mr. Isaacs. "As you know, all the nations in the world have been engaged in experimenting in order to produce the real thing, and at last wireless has accomplished the seemingly impossible. This development is, of course, of the greatest importance to film producers. The spoken picture play has always been the goal at which they aimed. The one great difficulty of making the speech of the actor coincide with his actions has been overcome."

By the new process when a man speaks or sings his voice is photographed at the same time, and the new animated picture will be screened from the same roll. Music, of London, says that the actual difficulties of production are minute and the cost is not extravagant.

S. E. OVERTON CO. ENLARGING

The S. E. Overton Co., South Haven, Mich., is building the third addition to its plant in response to the rapid growth of its business. This firm makes piano benches and legs for talking machine cabinets and its product is in great demand all over the country.

Rice & Co., Vicksburg, Miss., have taken on a new line of talking machines which they plan to feature extensively.



HERE IT IS

The
FLETCHER UNIVERSAL
TONE ARM and REPRODUCER

Gives Proper Playing Weights for all Records. No Adjustment Screws or Springs.

SAMPLES \$8.00 Specify 8½" or 9½" arm

FLETCHER-WICKES CO., 6 East Lake Street, Chicago, Illinois

THE GEORGE MCLAGAN FURNITURE CO., STRATFORD, ONTARIO, EXCLUSIVE CANADIAN AGENTS



There's Really Only One Way to Make Records Life-Lasting—

AND daily more and more owners of talking machines are coming to know what this one way is. No doubt you already know; so do scores of your better-class customers. But ALL should know the "secret"; it's to use

B & H Needles Exclusively

In the interests of better business—"trading up"—you ought to earnestly endeavor to boost your Fibre Needle sales. Through your salesmen, tell your clientele what the consistent use of this popular stylus means: pure, sweet tone, unmarred by hiss; subdued volume of sound; absolute preservation of the records and consequent protection of the record investment.

This plan will result, we confidently believe, in increased volume of business in costlier records and enlarged sales of higher priced instruments. Just try it.

Attractive color-circulars and other sales helps Free on request.

B & H FIBRE MFG. CO.

33-35 W. Kinzie Street, Chicago

CONVENTION OF EDISON DEALERS IN NEW YORK GREATEST EVER HELD

Many Notable Trade Subjects Discussed by Leaders in Edison Industry at Victory Convention Held in New York City, June 24 to 27

The fifth annual convention of Edison dealers, also known as the Victory convention, took place at the Hotel Commodore, New York City, June 24 to June 27, inclusive. It was the most successful affair of its kind ever staged, both from the standpoint of attendance, which ran up to nearly 1,500, and in practical results accomplished during the business sessions. The opening days of the convention were devoted to the meeting of the Edison travelers, the exhibit of special new period models, shown in the Western ballroom of the hotel, and the exhibition by the advertising department of the comprehensive lines of all forms of publicity utilized in connection with the Edison business. All sessions, for the first time, were open.

On Thursday morning, June 26, the convention started with a popular concert by one of the finest Edison orchestras. Thomas J. Leonard, general sales manager of Thomas A. Edison, Inc., opened the Victory convention with a hearty welcome to the great host of Edison dealers who had migrated to New York to join in the convention proceedings. He introduced H. E. Blake, Edison dealer of Philadelphia, as the chairman of the convention, who acquitted himself with distinction in this important post.

William Maxwell Outlines Future Factory Plans

The business program opened with an address by William Maxwell, vice-president of Thomas A. Edison, Inc., the subject of which was "What the Factory Plans to Do for You."

Mr. Maxwell contrasted the present situation in America with that of a year ago by quoting the headlines from the New York Sun which appeared the opening day of last year's convention and the headlines from that day's issue. Then it was all war, now it is peace. He told how, while the United States was at war, the Edison organization had wholeheartedly and voluntarily devoted its efforts toward war work and explained how this patriotic but not-to-be-regretted policy had handicapped the Edison Co. as regards production when comparison is made with certain other manufacturers of the talking machine industry who did little or nothing to help Uncle Sam win the war. He then went on to say:

"However, I did not come here to prate of patriotism or offer it as an excuse. There is a temporary shortage of certain types of Edison phonographs. What is being done to relieve that shortage and when will it be relieved? Those are the questions you want answered.

The Temporary Shortage

"The war is over, but you notice that the hotels are still stingy with sugar, butter and bread. The war is over, but most of the department stores continue to give us war-time service. The war is over, but smokers are still dodging behind buildings to get a light from matches of 'war-time quality.'

"During the war, as you all know, it was difficult to get skilled labor in factories, if the factories were not engaged in war work. In some of our cabinet factories we were obliged to close our eyes to certain things that we would not have tolerated in normal times.

"When the armistice was signed we said to our cabinet people in effect: 'We have been easy with you, because we knew what you were up against. Now conditions are different. You must meet specifications 100 per cent. on the

Chippendale. The new Sheraton is a real piece of furniture. It's got to be made and finished better than you ever thought of making the C-150.' We went through the entire line in that way.

"What happened? Of course, everybody said

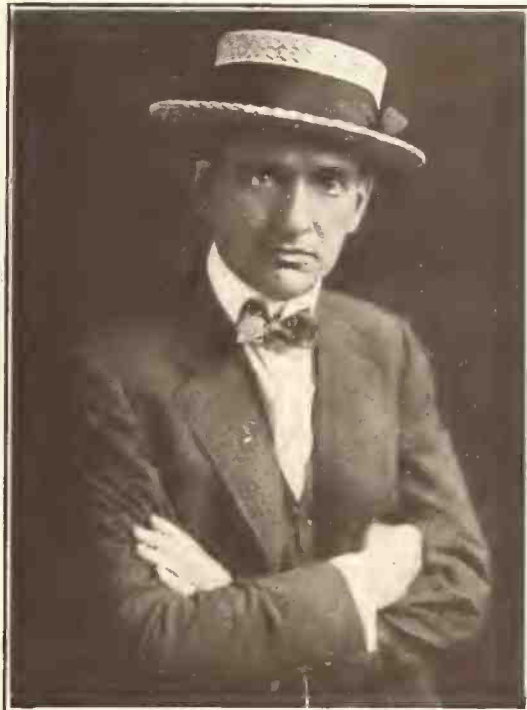

William Maxwell

'Yes,' and promised certain deliveries on certain dates. I suppose it was hard for the cabinet manufacturers to make their men and foremen realize that the war was over. At any rate, the cabinets did not come through the way we wanted them, and they were rejected. Literally thousands were thrown back by our inspectors. The cabinet men said: 'You claim you are in urgent need of cabinets, that your dealers are suffering for goods. There is only one way to get cabinets and that is to lower your



H. E. Blake, Chairman of Convention standards and relax your inspection. You will bankrupt us and put yourselves out of business if you don't.' We said to the cabinet men: 'If that is the case we might as well begin now to get ready to go out of business, as the Edison Co. will not lower its standards or relax its inspection one iota.'

"We sent a neutral expert to several of our cabinet plants to make an unprejudiced investigation. He reported: 'You are enforcing the most rigid standards that were ever in effect in

any furniture factory, but in view of the superb design of your cabinets I believe you are doing right.'

"One of the best-known retail furniture dealers in the country said to our general purchasing agent recently: 'You folks are preparing to make the Edison phonograph the finest piece of furniture in a man's home. We handle some pretty high-priced furniture but nothing that we are as particular about as you are about your cabinets.'

Production Approaching Normal

"Well, we finally won out. It took courage—it has given me a lot of new gray hairs—to refuse cabinets when we knew you needed them so badly, but it was necessary. To-day I believe every Edison cabinet factory is working to our standards in good faith. Cabinets are now flowing in fairly good quantities and the flow is increasing every week. July should bring material relief and August should place us almost abreast of our orders. We have put our own expert production men in several of the outside cabinet factories and they are accomplishing good results. We are doing everything possible to co-operate with our cabinet manufacturers. Recently we settled a strike which threatened to put three of our cabinet factories out of business for a month or more. We are sparing no effort and no expense to increase cabinet production and the results will soon be apparent.

"Our present cabinet specifications are so high that wood-working concerns which previously had supposed they could not afford to consider the manufacture of phonograph cabinets have discovered, as the Aimones did, that they have never made anything finer than Edison cabinets, and accordingly the ranks of our cabinet makers are being recruited by concerns whose work will correspond to that of Aimone. There is no furniture maker in the world to-day who is too exclusive or high class to make Edison cabinets.

No Shortage of Motors

"You have noticed that I speak only of cabinets in connection with the shortage of Edison phonographs. There is no shortage of motors and reproducers. We are making twice as many motors and reproducers as we ever made before. Our factory organization was never so efficient as now. The morale of our workers was not lowered during the war. Most of the war work which we did called for very fine workmanship. We did some work that other people couldn't do and I think the Government came to rely on us a great deal. I recall the case of a certain manufacturer who is internationally celebrated for the supposedly fine character of his work, but who fell down ingloriously on a certain implement of warfare which called for a high degree of precision. The Government asked us if we thought we could handle anything so fine as this particular device. We replied that while there were lots of things too coarse for us to make, there was nothing too fine for us, and we proved it quickly, to the Government's great relief and satisfaction.

"We are very proud of our manufacturing organization. We have good men. They feel that they are getting a square deal and they are happy. I don't believe any agitator could interest them for a second. I don't believe you need to worry about strikes at the Edison manufacturing laboratories.

"I suppose I should say a word about disc
(Continued on page 38)

CONVENTION OF EDISON DEALERS IN NEW YORK GREATEST EVER HELD—(Continued from page 37)

Re-Creation production. All of you know by this time that we can make plenty of Re-Creations. Production is not as yet scientifically distributed, for the very simple reason that the moulds give varying outputs. A new mould is being introduced which will overcome this difficulty, and also provide a product of remarkably uniform quality.

"So much for what we are doing in the way of producing goods for you, and I find I have consumed nearly all of my time with that subject, without getting down to the topics about which I expected to talk. Fortunately Mr. Fuller is to talk to you to-morrow in detail about our various plans for dealer co-operation.

"Already you know about the Diamond Amberola co-operative advertising campaign. The dealer who doesn't push the Diamond Amberola this fall is overlooking a good thing and every dealer who is pushing the Amberola will cer-

tainly want to get in on the co-operative advertising.

to Miss De Wolfe and her work and to all that her endorsement of the Edison period cabinets means. He said, in part:

Victor J. Petry's Talk on the Importance of Period Styles

"What I am going to say may hurt. Until your reproductions of period pieces were introduced we decorators had our own troubles trying to make those commercial, expressionless masses of mahogany or oak blend with the general furnishings, and while I admit that some of your salesmen weighed carefully the pros and cons of what is termed 'eye values,' we had to look upon same through telescopes and smoked glasses.

"The only available process then known to us was that expedient so lately and successfully tested—camouflage. We had to resort to paint

cleverness, versatility and resourcefulness in so many ways that I am sure she will give the same good account of her prowess in this particular regard.

"Let us not attempt to get up '57 varieties of design' merely for the sake of saying we have so many periods in stock, but let us adhere to what is now and always will be considered the best, if only a few very true and clever, reproductions."

Dorn Talks on Canvassing in a Metropolitan District

Following Mr. Petry came John Dorn, an Edison dealer of West New York, N. J., who took as his topic "Canvassing in a Metropolitan District." He said:

"Canvassing is the keynote and the foundation of salesmanship in placing many articles on the



Panoramic View of Edison Dealers From All Parts of the Country Who Attended

and then to the most neutral of tones blending with the environment with perhaps a faint suggestion of embellishment such as striping or a limited amount of polychroming. We thought of period cabinets (this is a fact) but hesitated to thrust them on our customers, being ignorant of the relationship of same to the mechanical device—a very important feature.

"I have been told of a firm in Grand Rapids who formerly paid their then designer \$3,000 per year. They were meeting serious and deserved competition till one decorator nervier than the rest told them they should more faithfully reproduce the gems of the antique. Finally they heeded his advice, secured the services of the foremost living designer for \$15,000 per year and empowered him to purchase any noted specimens obtainable and no questions asked as to price. Their production and sales to-day far surpass and outclass any would-be competitors.

"Not only Mr. Rockabilt and Mr. Van Astor should be able to enjoy the happy combination of good music enclosed in a superior case. Mr.

market. The New Edison is no exception and our experience has shown us that direct canvassing is directly responsible for selling more phonographs than newspaper advertising, circular letters or other numerous forms of publicity.

"I do in no way want to leave the impression that newspaper advertising, etc., is not essential. We use the newspapers, mail out circular letters to follow up our prospects, and find the more publicity the more sales. But by direct house to house canvassing you get in touch with every home and every family. This gives you an opportunity to see personally if there is music in the home or not, and if there is any possibility of making a sale. I was asked to relate the methods we use in going about our work.

Make Your Call a Personal One

"As everyone knows, canvassers are about as welcome to the average home as prohibition is to the longshoreman, and for this reason you must make your call appear a personal one. This can be done by making a mental note of the party's name in the letterbox as you ring the apartment doorbell. Say, for instance, the party's name is Jones, and is the lady who responds to the bell. Your first remark, "Good morning, are you Mrs. Jones?" makes Mrs. Jones believe you have called to see her personally on some business, and she, of course, informs you that that is her name, and waits to hear the nature of your business.

"We then introduce ourselves, asking if she has a phonograph. The lady will inform you if she has one or not, and if she has none there is a good chance for a prospect, and you proceed accordingly.

"It is more than surprising to find, considering the enormous phonograph business done each year, the number of homes without them, people who are in circumstances to well afford them, many who have thought of having one at some time or other, but have never fully made up their minds. It is this class especially where canvassing counts, and with a little persuasion a sale is very often made. A few weeks' canvassing will assure any dealer, I am sure, of the number of prospects obtainable (especially in thickly populated districts), if they are only gone after.

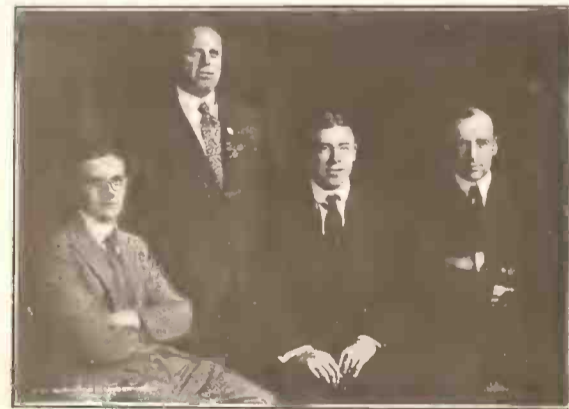

The Boston Group

Left to right: T. E. Dean, F. S. Boyd (standing), L. H. Ripley and G. R. Coner.

Smith, Mr. Jones, and Mr. Brown should have their cabinets represent their personal tastes and environments equally as well as their wealthier brother. There is no reason why they should be compelled, on account of their limited wealth, to have to content themselves with bulky cubic foot and monumental effects.

"The whole matter of case designing is, if I might say so, in its infancy. America has so often, and especially lately, shown her alertness,

Substitutes for Miss De Wolfe.

Following this Victor J. Petry (Beaux Arts, Paris), New York City, substituted for Miss Elsie De Wolfe, the famous authority on good furniture and interior decoration. Miss De Wolfe, who has recently given a very powerful endorsement to the Edison period cabinets, was scheduled to give a talk in person, outlining her opinion on the New Edison period designs from the standpoint of artistic home furnishing. Miss De Wolfe, however, was detained in returning from Europe, which accounted for the appearance of her associate, Victor J. Petry. Mr. Petry paid a warm tribute

CONVENTION OF EDISON DEALERS IN NEW YORK GREATEST EVER HELD—(Continued from page 38)

"If you find your party has no music we usually ask if she has ever considered a phonograph as a means to give her that part of her entertainment which has long been lacking. She may tell you that she had been considering one some time ago, but has given up the idea, or was considering getting one later. It must be borne in mind that you are not selling some small article, where people will fall quickly for your proposition, and you hardly ever find a party who is so anxious as to tell you directly that she wants a phonograph.

Getting an Instrument in the Home

"For this reason we always have an Edison on the auto and when a prospect is found where there is a possible chance for an immediate sale we try to place an Edison in the home on approval for a period of two or three days. This can usually be done by explaining the re-creation of the human voice by Mr. Edison's new \$3,000,000 phonograph, and telling them that it

indexed on a prospect card, with name and address and whatever remarks may be of assistance on the return call, and this is filed away for the month in which it is believed the prospect can be interested.

"When that month arrives a return call is made, and we have sales on record where we have followed up a prospect two or three years and more before making a sale. These return calls always keep you in the prospect's mind, and when they do think of buying a phonograph they think of your store, and your chances of selling them are several times greater than if you had not followed them up diligently. They then come to you, and it is then usually an easy matter to close the sale.

After Prospects in the Winter Months

"In the winter months, when you are busy, and it is impossible to see all your prospects, a circular letter goes a great way in bringing the sale to you. We have used some of the fac-

years in determining just what constituted the ideal quality for diamond points, and of the very careful work which is required in shaping the diamond points. He said that there are seventy-five operations in making a diamond point, practically all of which have to be conducted under a microscope which magnifies up to 1,000 times the normal size. He said: "The diamond must be shaped to fit into the groove exactly, and considering the fact that on the Edison record there are 155 lines to the inch it will be evident how perfectly shaped the diamond must be to fit exactly so small a groove." He also stated that the Edison Laboratories have spent more than a million dollars in proper equipment and experimentation on the diamond point and that no other manufacturer of diamond points could hope to acquire the necessary equipment and knowledge for a smaller investment than a half million. He described the polishing and rounding machine



the Edison Convention Held at the Hotel Commodore, New York, June 24-27

Photo by C. F. Allen © Talking Machine World.

is Mr. Edison's desire to have as many people hear the instrument as possible, and that he is using this method of introducing it, immaterial as to whether the party is ready to buy at the present time or not. Once your phonograph is in the home you have a good opportunity of selling it, for experience has shown us that 60 per cent. are never taken out again.

"We always leave about eighteen records and vary the selections, using a variety to make sure some of the re-creations will meet the musical requirements of the prospect.

"After the phonograph is placed we show the prospect how to operate the instrument, and demonstrate a few selections, generally using 80160, 'I'll Take You Home Again, Kathleen,' and 82536, 'Ave Maria,' the old favorites. We then leave, telling the prospects that we will be back in a day or two and to give the phonograph a good trial. Our return call is generally in the evening, when all of the family are at home. You then meet the husband and the rest of the folks and wait to hear the verdict.

"They most always tell you how pleased they have been with the instrument, but usually have some excuse to offer, such as that they have large obligations to meet, that the cost of living is too high, or any other of the innumerable ones that are always presented to a salesman in any line. Then, if these objections can be overcome, which they very often can, your sale is made, and you have another Edison booster, besides another party to sell records to, which you would never have had if you had not canvassed and used that little persuasion which always leads to sales.

Successfully Overcoming Objections

"Furthermore, it does not mean that you have to go out canvassing six to eight hours a day every day in the week. We usually canvass about two and one-half hours a day about four days a week, but we make it a point never to miss a house or a family, for the party on the fifth floor of an apartment wants music as much as the party on the first floor, and there is never a week that passes but we can show some results from direct canvassing.

"It is not alone the immediate sales you make, but the prospects you obtain that lead to sales later. Every one who we believe is interested or can be interested at a later date is

tory's circular letters and literature with very pleasing results.

"In addition, every person you sell is a booster for you, and with the Edison satisfaction they receive they tell you of their friends, and send them to you. Several of our customers whom we have sold through canvassing have sold from four to six phonographs for us and sold them to friends and relatives a good way from our territory who have gone out of their way to come to us.

"Make your customers believe you are giving them better service than they can get elsewhere, make them believe you are going out of your way to accommodate them, and they will go out of their way to help you make sales."

Geo. E. Clark Tells When a Diamond Is Not a Diamond

George E. Clark, acting manager of the Disc Re-creation Laboratories, then gave a very interesting talk on the subject of "When a Diamond Is Not a Diamond." He outlined in detail the exquisite skill that is required in mak-

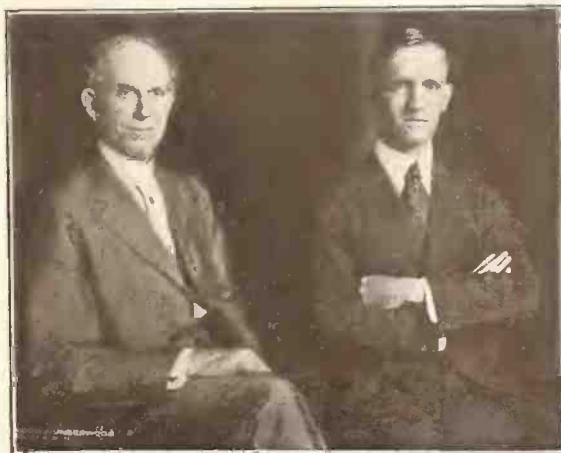

The New Orleans Group

Left to right: E. E. Hammond and A. Schreiber,

ing a diamond point for the New Edison. He told how the diamonds for the Edison diamond point are secured from the great diamond market of London, how it is necessary to select absolutely clear crystals of the very highest quality. He went on to explain how the Edison Laboratories were engaged for a great many

which the Edison organization has developed after seven years of intensive study.

James P. Lacey, an Edison dealer of Peoria, Illinois, came next on the program and discussed "Enthusiasm with a Big E." He said:

James P. Lacey Tells Why Enthusiasm Is a Power

"You've been to a ball game on a day when your home team seemed, at the opening of the ninth inning, hopelessly beaten by the visitors. As the first man on your side, wearing a down-and-out expression that perfectly reflected the thoughts of the majority of your home town rooters, came up to the plate in the last half of the ninth to bat, a long lanky individual—whom all your business men classified as a no-account, good-for-nothing baseball nut—rose from his place in the bleachers, waved his skinny arms and pierced the murky depressing atmosphere of that ball park with this clarion command, 'Now, then, fellows, let's give 'em hell!' In just such proportion as your various natures ordinarily respond to the 'never-say-die-spirit' you rooters took up the cry and immediately your team evidenced a re-creation of fighting spirit. You won that game. Your town nut saved the day. He was an enthusiast.

"Enthusiasm, properly directed, always wins. An enthusiast is always a nut, but nuts are not always enthusiasts. That town nut, had he properly directed his enthusiasm along commercial lines, in place of idling it away on dope sheets and batting averages, would have become your biggest business man.

"Consult your histories and you'll find that those who have dreamed big dreams, those who have been the most outspoken of radicals, are the ones to whom we pay the greatest homage. They are the ones in whom the spirit of enthusiasm is most pronounced. While I could occupy an hour in so doing, surely I need not delve further into the life of business, invention, sport, war or finance to illustrate to you the necessity of enthusiasm to our individual success.

"You show me a man without enthusiasm and I'll show you he has no personality, pep, ginger
(Continued on page 41)

Edison Message No. 45

Nearly all of our boys have returned from over seas. They are going through a period of readjustment to civilian life. Music is the great stabilizer, the great mental gyroscope that will help divert their minds to normal channels and ease them back into peaceful pursuits with a minimum of friction and with a renewed, a revived activity and enthusiasm.

This is the best reason in the world why Edison Dealers should now redouble their efforts to supply every home with a New Edison.

THOMAS A. EDISON, Inc.

ORANGE, N. J.

CONVENTION OF EDISON DEALERS IN NEW YORK GREATEST EVER HELD—(Continued from page 39)

or any of those qualifications that make for big success.

"You can't successfully handle your dealership without these qualifications. Hear me, that man who criticizes, finds fault, spends his hours and days in worrying over the things which have not been done, is rapidly approaching stagnation. He is engendering in his employes, in himself, in his whole business organization, the spirit of pessimism, a word that also spells failure.

"If you are handling a line of merchandise about which you no longer can enthuse, either go take a vacation and reverse yourself or give it up. There are only two kinds of dealers; the live wire or enthusiast and the complainer or pessimist. You are in one or the other class. As the darky says, you either 'is' or you 'ain't.'

"There are several very necessary assets which every business, to be successful, must have. Were I to ask you the most important you'd yell 'Cash' at the top of your lungs. Yes, I admit it is important and further I admit it's easier to be an enthusiast when the bank balance is bulging than when the reverse is true, yet I question the all importance of cash. How about the asset of Character, Up-to-dateness, Honest Dealing, Popularity, Service, Vision, Pleasantness, and Imagination? Never heard of listing some of these things as business assets, did you? There are many more that could be added to the list. The trouble is, so many of us take too many necessary qualifications for granted. Why not analyze your business and yourself as well and determine positively just how you measure up to your job? Call the following statement ridiculous if you wish, but weigh it well before passing judgment: I consider Enthusiasm, intelligently directed, the greatest business asset of all—greater than 'Cash' or 'Credit,' because our store was a rank failure when cash was plentiful and enthusiasm absent.

"If you could analyze the story of the Diamond Disc Shop, of Peoria, you'd find ample proof of what enthusiasm can and will do. You'd find there was a time when cash gave out because of the lack of enthusiasm; a time when nothing in God's world but enthusiasm could save the situation. Enthusiasm entered, put new life into the organization, sold goods, created recognition over all the country for the store; as a matter of fact made that store almost everything that it is to-day.

"Oh, I could tell you a thousand little stories about enthusiasm as regards our shop, but, since figures better tell the story, listen: Our business in 1918 doubled the 1917 business with less than \$1,000.00 additional expense. The sales for last December exceeded the entire sales for the first twelve months in business, and the sales this year have each month doubled the same month last year. And, gentlemen, enthusiasm did it.

"Don't imagine you can qualify as a real wide-awake dealer unless you are able to be a consistent as well as an everlasting optimist and enthusiast, because it can't be done. Too many of you have waited for the 'cream' stage to arrive before you thought of going after business. When that time does arrive there won't be any business for you to go after because the fellows who have fought on in spite of the difficulties will be the fellows who have covered the entire territory while you have been idling and worrying your time away.

"May I read you, in conclusion, the following verse from 'Success':

The man who wins is the man who does,
The man who makes things hum and buzz,
The man who works and the man who acts,
Who builds on a basis of solid facts;
Who doesn't sit down to mope and dream,
Who bumps ahead with the force of steam,
Who hasn't the time to fuss and fret,
But gets there every time—you bet.
The man who wins is the man who wears
A smile to cover his burden of cares,
Who knows that the sun will shine again,
That the clouds will pass, and we need the rain,
Who buckles down to a pile of work
And never gives up and never will shirk
'Till the task is done, and the toil is sweet,
While the temples throb with red blood's heat.
The man who wins is the man who climbs

The ladder of life to the cheery chimes
Of the bells of labor, the bells of toil,
And isn't afraid his skin will spoil,
If he faces the shine of the glaring sun
And works in the light till his task is done;
A human engine with triple beam
And a hundred and fifty pounds of steam.

Palmer Talks on News Value in Advertising

Following Mr. Lacey, Arthur J. Palmer, advertising manager of Thomas A. Edison, Inc., discussed the matter of "Advertising That Has News Value." His speech ran as follows:

"What constitutes a good advertisement? I should hesitate to pass judgment. I am frank to confess that I do not know positively just



Arthur J. Palmer

what does constitute a good advertisement, but I have my own ideas.

"You might think that the shouting, circus type of advertisement, megaphoning to the public the fact that they can purchase the New Edison for almost nothing down and less than nothing a week, is good advertising, whereas I might think that an ultra-dignified advertisement, utterly devoid of all striking display and absolutely shunning even the thought of terms, is good advertising.

Distinctiveness in Advertising

"However, I am convinced that the character of the Edison magazine advertising which we have been doing for the past nine months is good advertising because it stands out from the ordinary routine of just plain copy on account of its distinctiveness. Each advertisement in itself constitutes a story, an account of something which has actually happened. It tells of a specific occasion on which a humanly interesting test of the New Edison's ability to recreate was made.

"When you open your morning newspaper you expect to find on the front page something different from that which you found the morning before. You eagerly scan the columns to find out what has happened, the latest occurrences out of the regular routine of daily life. Suppose you should find on the front page the same themes, the same stories in a new form, with new headlines, simply paraphrased from yesterday's stories. You would soon grow tired of reading that paper and would very shortly cut it out altogether.

"Then, isn't it logical to assume that a news twist to advertising greatly increases the reader's interest? I think there is no doubt about that, and that is why we strive to give every Edison magazine advertisement a news angle.

"You will recall the Lazzari advertisement, the Case advertisement, the Ciccolini advertisement and particularly the Fields advertisement.

Each one told of a happening of interest to the music-loving reader, each was a distinct advertisement in itself, each one possessed an individuality of its own, telling a story of its own, though all on the same subject.

"You remember when a boy, how when a crowd would gather up near a corner and people would come running from all directions, all the fellows would shout 'Something's up.' Something had happened out of the ordinary routine, something that quickened your interest and appealed to your natural curiosity to find out what was doing. Something of 'news value.'

Lessons from Motor Publicity

"When an automobile manufacturer wins a great race, like the recent Indianapolis classic, the next morning his announcement of the achievement appears in the papers. His car has accomplished a great feat. He does not come out with the mere announcement that his car has four cylinders, or six or eight cylinders. He hits you between the eyes with a live, interest-compelling statement to the effect that his product has demonstrated its superiority over its competitors. So it is with the tire manufacturer and the makers of the various automobile accessories used on the winning car.

"Recently I saw a striking advertisement of a new vacuum bottle that has an unbreakable lining. The figure of a man was shown handing one of the bottles up to the aviator of one of the overseas aeroplanes and the copy said that Hawker, Alcock and Read all had taken this make of vacuum bottle on their perilous trips across the ocean. How intensely interesting is such advertising to the prospective purchaser of the respective products mentioned.

"Remarkable in their field as such products are, I am sure you will agree with me that we have a much more interesting and far more wonderful product and a still more interesting story to tell—and I feel that we are getting our story across to the magazine-reading public with what I might call a 'front-page punch,' and I feel that that is due to the news character of each advertisement.

"Do not misunderstand me. I am not lacking in appreciation of the power of reiteration, but in order to make an advertisement one that will tell an interesting story we must have something more than mere reiteration of a basic theme. We must present our story in a new garb each time it appears, we must dress it up. We are endeavoring to do that by giving each Edison advertisement an individual appeal, a newsy slant that will make it as palatable as the news stories on the front page of your paper.

"It is our present intention to continue these advertisements that have news value so long as subjects hold out, perhaps here and there injecting an advertisement like that of our recent announcement of the new period cabinets.

"If we are correct in our judgment we are making a favorable impression with our present line of advertisements on the magazine readers of the country. We are creating reader interest right in the very neighborhood; in fact, in the immediate vicinity of every dealer present. That interest is an asset. What have you done about it? What are you going to do about it? We are planting the seeds of favorable impression. Are you fertilizing the soil and are you nurturing the crop by running the interlocking advertisements? That reader interest will evaporate into thin air if you do not concentrate it on your store.

"We should like to print the name of every Edison dealer at the bottom all our magazine advertisements. Of course, that is impracticable, but the next best thing is for you to run the interlocking advertisements and shoot out to your prospects the interlocking folders which we furnish coincident with every magazine advertisement we run. Get all that's coming to you out of our national advertising.

"You will find it highly profitable to tie up
(Continued on page 42)

CONVENTION OF EDISON DEALERS IN NEW YORK GREATEST EVER HELD—(Continued from page 41)

your store with 'Advertising That Has News Value.'

H. M. Purdy's Remarks

Following Mr. Palmer, H. M. Purdy, an Edison dealer of Atlanta, Ga., spoke on "Our One Best Bet—the Official Laboratory Model." He outlined why the Official Laboratory Model of the New Edison is the best seller, due to such reasons as it is the model most extensively featured in Edison advertising, it is the model invariably used in the Edison tone-tests, it is the model used in comparison tests of all kinds, etc.

The Amberola Advertising Campaign

John A. Sherman next discussed "The Amberola Co-Operative Advertising Campaign." He spoke of the various ways in which the Amberola headquarters at Orange and the Edison Amberola jobbers are co-operating with the Amberola dealer for an ever-increasing business, and emphasized the fact that the Amberola business is not declining and that it is by no means an instrument the sale of which is confined to the rural districts.

Making Inspection Service Pay

A. D. Ulster, Edison dealer of Meriden, Conn., talked on "Making Inspection Service Pay." In his speech Mr. Ulster digressed to emphasize the extremely important position that service occupies in the modern business world. He enumerated several instances of where his company has rendered special services of a kind that might be deemed unnecessary or uncalled for, with the result that sales of an excellent character were made.

William Maxwell closed the speaking program for the Thursday morning session by reading a speech of R. L. Aimone, head of the Aimone Mfg. Co., New York City. Mr. Aimone was scheduled to give in person an interesting talk on the subject of period cabinets, the Aimone Galleries at present making a large number of period cabinets for the Edison Co. He was, however, called away by the sudden death of a relative, for which reason Mr. Maxwell read his speech to the conventionites. Mr. Aimone's address consisted of a glowing tribute to the quality and design of Edison period cabinets.

The Play "Eye Value" Makes a Hit

The session for Thursday closed with a novel comedy in one act, entitled "Eye Value," written by William Maxwell and produced by Verdi E. B. Fuller. The play took place in the office of Zebolin Oldfather, characterized as "An Edison Jobber and a Wise Old Bird." In the course of the play this same Wise Old Bird was duly convinced by A. Goldstein, a dealer-buyer, representing the Farmers' Bargain House of Intra-Reuben, Ill., that what the public wants to-day are high-class cabinets for phonographs, such as are found in the period models of the New Edison. The play was admirably written, as might be expected considering the authorship, and was well acted throughout. After the play, which finished about 2 p. m., the meeting adjourned until Friday.

Edison's Address Feature of the Session on Friday

The next morning, Friday, June 27, the Edison Dealers' business session resumed, starting in with a concert by the Edison Orchestra. The first event on the program was Thomas A. Edison's message to the convention, which was delivered in excellent form by William Maxwell as follows:

"A new order of things is emerging from the events of the past five years. Whatever may intervene, the ultimate result is going to approach more closely a square deal—for labor, for capital, for the merchant, for the farmer, for every one. The employer who is not square with his employes, or the employe who is not square with his employer, is going to be out of step with the times.

"Demagogues may muster a following of il-

logical radicals who advocate injustice as a means of gaining justice, and stiff-necked reactionaries may selfishly oppose the progress which destiny has decreed as humanity's reward for the sacrifices that have been made, but in the end there will prevail a just and honest basis for the relations between capital and labor.

"This new relationship cannot be legislated into existence. It will spring from the conscience and patriotism of the people. The time is coming when the unjust employer and the disloyal employe will share equal odium in the esteem of society at large.

The Efficacy of the Square Deal

"The square deal is fatal to radicalism. There can be no social revolution in the United States or Canada for the very simple reason that our Government and the Canadian Government are founded on the idea of giving everybody a fair show. There will be few disturbances of con-



Thomas A. Edison

sequence if a majority of us adopt the square deal as our business creed and our social creed. One lone man, who believes in the square deal and has the courage of his convictions, might very possibly convert a whole community. Accordingly the good citizen to-day, in addition to conducting his individual business in harmony with the Golden Rule, has the duty of raising his voice and using his influence in behalf of justice for all—justice as much for the railroad corporation as for its employes, and for the common laborer as well as for the highly skilled artisan. I believe that Edison dealers will recognize this duty and that they will not be found wanting in its performance.

"Of our own business I think I need speak but briefly.

"A large production of disc Re-Creations is already an accomplished fact and steps are being taken practically to double our present production.

"Our only problem at the present time is to obtain a mould that will give us a definite production of absolutely uniform quality. We are introducing such a mould and its use will enable us to get our supplements on schedule and give us a more uniform product.

"The shortage of disc phonographs has been due to our uncompromising determination to have cabinets of the finest quality. We have finally succeeded in getting our standard accepted by the various manufacturers and the shortage of phonographs will be materially relieved in the near future.

"As most of you know, I devoted practically all of my time to Government work from January 1, 1917, to November, 1918. It is not my habit to lavish praise upon my business associates and employes, but it is no more than fair for me to say that in my absence our organization made an extremely good showing in the face of numerous difficulties. Thanks to the responsibility placed on our organization during the war I now find, much to my satisfaction, that the business requires less attention from me and that I accordingly have more time for the phonograph research work, in which I take such a keen interest and from which I derive so much pleasure.

Symphony Orchestra Recordings

"I have already renewed the experiments on symphony orchestra recording, which were interrupted by the war. It is too early to make any definite prophecies, but I feel confident that sooner or later we shall be able to record a full symphony orchestra of ninety-four pieces with a fidelity which will enable us to sustain a tone-test in comparison with the orchestra. Please understand that this does not mean a new record. It will be the same kind of record we are now making, although it will probably have to be twelve inches in diameter.

Continuous Research Work

"I have assistants working constantly—under my direction—in research that covers every phase of phonograph development. I am very happy to be able to say that, so far as I am aware, in the past six years no one has announced a so-called improvement or development in the phonograph art which involved a principle that was unfamiliar to us. I confidently predict that the same thing will be true during the next six years, and, for that matter, the next sixty years. In other words, we are in front and we intend to stay in front. By this I do not mean that you are to expect new and unusual types of phonographs or records. Our progress will be marked by improvements and refinements that will be reflected in a superior musical result, but that will not keep the trade in a turmoil of change. The method which we adopted in introducing the new period cabinets illustrates, I think, that we recognize that changes in our lines must be made in such a way that the dealers will not be prejudicially affected.

"Improved conditions make it possible for us to do a great many things for you dealers that we have not been able to do in the past. This convention has been chosen as the occasion for announcing some of our plans for dealer co-operation. I sincerely trust that the results will afford us justification for increasing our expenditures in this quarter.

Assurances of Future Prosperity

"None of us has the gift of looking into the future with absolute certainty, but I think all of us are satisfied that the next ten years hold large rewards in store for every one who is identified with the Edison phonograph. There may be temporary disturbances in business during that period, but basic conditions in this country are so exceedingly favorable that I think we need have no serious apprehensions and that we are all justified in going ahead with absolute confidence.

"When you go home from this convention I hope that each of you will carry with himself, or herself, the conviction that the Edison Co. will do its best in every possible way to serve your interests and merit a continuance of the loyal support which you have given it in the past. Also I should like to have you feel that the relationship between our company and yourselves is a little closer than the relations which ordinarily exist between a manufacturer and his distributors. All of you have my sincere best wishes."

The New Turntable Tone-Test

E. C. Boykin followed Mr. Maxwell and described in detail the new turntable tone-test, which has recently been put forth by the Edison



THERE is character to Stephenson accessories a character that adds a clearly defined selling value.

The polished edge of the turntable protects the felt against wear and fraying and adds to the attractiveness of the table-board. The Speed Regulator, too, is of a new design that permits the entire surface to be heavily nickel-plated and highly polished.

The brake acts upon a smooth track on the under part of the turntable, stopping it smoothly and promptly without any possible injury to the motor. Possibly these details may appear as of minor importance but these Stephenson character accessories add a clearly defined selling value.

STEPHENSON
INCORPORATED
One West Thirty-fourth Street
New York City

CONVENTION OF EDISON DEALERS IN NEW YORK GREATEST EVER HELD—(Continued from page 42)

organization, and which consists of placing several different makes of instruments on the same turntable so as to give them the same location. The plan is to have the dealers use the turntable whenever the New Edison must be sold in competition with other makes of instruments. Mr. Boykin outlined the conditions of the test in his talk, and also gave several turntable tone-tests, which made a distinct impression upon those assembled. He also rendered a report on the results that have been attained by the different Edison shops which have already put the turntable test idea into practice.

How to Get Part of Half Million

Verdi E. B. Fuller, Director of Sales Promotion of the Edison Co., followed Mr. Boykin and talked on "How to Get Your Share of That Half Million Dollars." Most of what Mr. Fuller said was of a confidential character, and therefore will not be reported in these columns. He outlined in detail how the Edison Co. proposes to spend an additional half million dollars for co-operation with the dealer along several definite lines.

Holden Talks on the Colgate Case

D. Holden, legal counsel of Thomas A. Edison, Inc., spoke next and took as his subject "The Colgate Case." He outlined the significant points in the proceedings of the Colgate case from start to finish, and dwelt on the extremely important bearing the final decision by the Supreme Court has on the matter of price maintenance. He said that the statements in the daily newspapers had from time to time reported this affair in an erroneous light, and that many believed the proceedings originated before the Federal Trade Commission instead of before the Federal Grand Jury of Virginia. The final decision rendered by the United States Supreme Court, he went on to say, gives the manufacturer and jobber the right to sell to whom he pleases, and also the right to announce in advance that said jobber or manufacturer may discontinue to sell to any retailer who does not uphold desired retail prices. On the other hand, he said, the Colgate decision makes it possible for any jobber or dealer who has purchased goods outright to sell at any price he chooses to sell at. In other words, the one restraining factor in the case of the retail merchant, as far as price maintenance is concerned, is the danger of his source of supply being cut off, should he start a cut-price campaign.

Pullin Chats on Record Service

F. C. Pullin, manager of the Record Service

Department, followed Mr. Holden and discussed "Catalog Numbers and Supplements." He informed the Edison dealers that the production difficulties which had been encountered during the war can now be forgotten, and looked upon absolutely as a thing of the past. He outlined the plans which the Edison Co. has in mind for supplying Edison dealers with all records of operatic, standard and popular selections in the desired quantities on time. He predicted great things for the future of the record business, as far as the Edison dealers are concerned.

Stimulating Musical Interest

E. F. Carroll, an Edison dealer of Waco, Texas, read an interesting paper entitled "Along Broadway, and Other Factory Printed Matter." In his talk Mr. Carroll described in detail how his company used the musical paper entitled "Along Broadway," published by the advertising department of Thomas A. Edison, Inc., to stimulate musical interest among the residents of Waco, Texas, particularly with a view to increasing the sales of Edison records and of the New Edison. He reported the actual results obtained by his company through extensive use of "Along Broadway" and the other co-operative advertising matter secured through the Edison advertising department.

Sigmund Spaeth Discusses the Future of Music

Sigmund Spaeth, musical critic of the New York Times, came next, and dwelt on "The New Edison's Part in the Future of Music." He heralded the phonograph as the biggest educational factor in music and stated that successful musical education consists, not in imposing what is not wanted and needed, but in allowing the public to discover music values for themselves. This, he stated, can undoubtedly be best accomplished through the medium of the phonograph. Mr. Spaeth believes that all persons have an inherent or potential appreciation of music, and that it simply requires familiarity with music to bring out this musical appreciation. Familiarity, he stated, breeds enthusiasm in the case of all art, whether it be painting, sculpture or music, etc. Ragtime selections are easy to popularize, according to Mr. Spaeth, because the melodies are all very old, and while the public is not perhaps conscious of the fact, they have really heard these melodies time and time again. Mr. Spaeth contends

that when the public is made equally familiar with the melody of the better class of music their enthusiasm for it will be infinitely greater and that for this reason phonograph dealers should bend every effort toward familiarizing the public with the melodies of the really great masterpieces of music. He went on by paying a very sincere and unreserved tribute to the musical perfection attained in the New Edison, and laid particular stress on its ability to reproduce tone quality and tone color. Mr. Spaeth closed by urging every dealer present to exercise the selective power which lies in his hand to induce the public to an intelligent ap-



A Notable Group

Left to right: Charles Edison (son of Thos. A. Edison), C. E. Goodwin and W. E. Kipp.

preciation of music in its finest forms, and said that, through phonograph dealers, the American musical taste can be developed to a really permanent enthusiasm and appreciation, to a point where America will be a really great musical nation.

C. M. Dahl on the Business Outlook

C. M. Dahl, vice-president of the Chase National Bank, next delivered a very interesting discussion on the business outlook as he sees it to-day. He made a very urgent appeal that every American citizen devote a certain amount of time to the conscientious study of public service to the end that our public officials may be of the type really required to guarantee the finest possible position for the American commonwealth. Business, he said, will take care of itself, providing the standard of public service is maintained on a fittingly high plane.

Selling Phonographs in the Summertime

Frank A. French, Edison dealer of Manchester, N. H., closed the speaking program with a talk on "Selling Phonographs in the Good Old Summer Time." In his talk he gave a list of the various kinds of entertainment which may compete with the phonograph during the summer months and also a list of the entertainments which may compete with the phonograph during the winter months. The balance sheet showed that actually there are more means of the public finding entertainment in the winter, particularly along musical lines, than in the summer, and that, therefore, the summer months constitute a particularly good time for pushing the phonograph business. He recommended that the dealer make a point of going out summer evenings and where he finds a family out on the porch, offering to have an Edison sent up and placed on the porch for the evening entertainment. He stated in cases where this had been done by his company the family would enjoy the music up to so late an hour that the instrument could be left with the family over night, in other words, moved off the porch, inside the home. By delaying for a day in calling for the instrument the family were given a chance to sell themselves on the phonograph, and in this way a considerable number of sales were effected during the middle of the summer season.

Open Forum Closes Sessions

The business sessions of the Edison Dealers' convention closed with an open forum. The following officials of Thomas A. Edison, Inc., were placed in semi-jury form before the Edison dealers: William Maxwell, vice-president; T. J. Leonard, general sales manager; C. W. Luhr, manager of the Edison phonograph

(Continued on page 44)

ALBUMS

BUY DIRECT FROM MANUFACTURER

THE BOSTON BOOK CO. INC.
40-46 W 20th ST NEW YORK

EDISON VICTORY CONVENTION

(Continued from page 41)

works: George E. Clark, acting manager of the disc record manufacturing laboratories; W. E. Sanborn, manager of the Amberola record plant; W. H. Miller, manager of the recording laboratories; F. C. Pullin, manager of the record service department; Verdi E. B. Fuller, director of sales promotion; Arthur J. Palmer, advertising manager, and John Constable, chief engineer.

As soon as the jury had duly seated itself the Edison dealers were invited to bring up any questions of any description which they wanted to be answered. Quite a number of those present availed themselves of this opportunity, the questions asked bearing both on merchandising and the technical end of the Edison business. All the questions asked were promptly and effectively disposed of by the Edison official particularly qualified to answer each individual question asked. The meeting was adjourned at noon.

Most Enjoyable Banquet Brings Convention to Close

The annual banquet of the Edison Dealers' convention, held in the grand ballroom of the Hotel Commodore on Friday night, June 27, was marked by unbounded enthusiasm and graced by many of the most famous artists in the musical world. Thomas A. Edison was the center of attraction and was wildly cheered by the 1,500 guests, who rose with one accord to give him a tremendous ovation when he entered the banquet hall. The big room was decorated with the Allied flags and the music was furnished by Earl Fuller's Edison orchestra, which also came in for its share of applause. William A. Maxwell was master of ceremonies and introduced each artist who appeared on the program. When he first appeared on the platform he received three rousing cheers and made his well-known bow, which should make him eligible for a place in the realm of the famous actors.

As for the dinner itself, it was complete and mere words cannot do justice to its merits. Everyone had the time of his life and even the delegates from the parched and thirsty zones got so used to the popping of the corks that they didn't dodge.

After the guests were comfortably seated they were startled by the appearance of a real live bear, which wandered up the aisle and paused to make a bow to Thomas A. Edison, and then mounted the platform to give the latest version of the "shimmy." "Big Jim the Jazz King" certainly made a hit with the dealers. Following this opening event the entertainers appeared in rapid succession and included some of the most famous Edison stars.

Mr. Maxwell proposed three cheers for Herbert E. Blake, of Philadelphia, for his good work as chairman of the convention and the response of those present left no doubt as to their feeling in the matter.

Amid redoubled applause the New Edison was moved to the center of the stage, following which "Frisco" appeared with his xylophone and gave an interesting tone-test of his own playing and its reproduction. Mr. Edison requested "Silver Threads Among the Gold," this being one of his favorite songs.

William A. Maxwell then rose and made the announcement which he had reserved for the occasion that Albert Linquist was the newest addition to the Edison staff of artists and the recreations of his songs would appear in the fall. Mr. Linquist sang the favorite song of the British Tommies, "Tommy Lad," which he sang when he was with the Red Cross in England at the outbreak of the war.

Miss Gladys Rice was the next singer, followed by the inimitable Al Bernard, who convulsed the entire gathering by his allusion to the key to his cellar. The subject seemed to be a very vital one to all, even to the delegates



Annual Banquet of Edison Dealers, Which Closed the Victory Convention, Held at the Hotel Commodore Friday Evening, June 27—Cross in Left Center Indicates Thomas A. Edison.

CONVENTION OF EDISON DEALERS IN NEW YORK GREATEST EVER HELD—(Continued from page 44)

from the arid States. "When you spend \$50,000 in one month on one girl there must be a lot to her," said Mr. Maxwell, ambiguously, as he introduced Leola Lucey, but there seemed to be no doubt in the minds of the guests that she was worth all of that. The Criterion Quartet sang "Ring Out, Sweet Bells of Peace" and responded to the encore with an original bagpipe number.

A telegram was read from Frieda Hempel, which speaks for itself: "All good wishes to the Edison convention. To-day is my birthday and I am drinking a toast here in the Adirondacks to the health of the dealers and to Mr. Edison and the organization. I saw the new catalog and think it is most beautiful and artistic."

Carl Jorn, the Metropolitan Opera star, sang a new song, "Singing to You," which will appear among the Re-Creations this fall.

The popular Marie Morrisey sang her favorites, "Just a Wearyin' for You" and "Way Down Upon the Suwanee River," while everyone joined in the chorus with a will. A man from Dixie then moved the dealers from the Sunny South with his "Caroline"—yes, it was Vernon Delhart. Glen Ellison gave "Roaming in the Gloaming" and his bit o' Scotch was delightful.

Anna Case Receives an Ovation

The appearance of Anna Case caused the conventionites to fairly outdo themselves and the Dallas contingent could hardly keep themselves from storming the stage, so greatly did they admire the noted singer. This was her first time at an Edison convention and she was forced to respond to encore after encore, while the crowded galleries implored her to continue. She sang one of her own compositions, called "Song to the Robin." The Flemming Trio followed Miss Case and played in their own pleasing way.

Next Convention in New York

Mr. Maxwell then mounted the stage and asked where the next convention should be held. Suggestions came back with the patter of a machine gun. He then asked if it should be held in Chicago and the Western delegates were loud in their cries of approval. But he dashed their hopes by saying that considering the distance from the Windy City the vote was larger than he expected, by which we are to infer that the convention will be held here next year. In closing Mr. Maxwell expressed his appreciation of the large attendance and the good work done by all to make the convention a success. Dancing then began in the West Ballroom and with the last waltz closed the fifth convention, which was declared the best ever.

SPECIAL EXHIBIT OF NEW EDISON PHONOGRAPHS SHOWN

Several New Period Models and Complete Line of Regular Models Exhibited at the Hotel Commodore During the Edison Victory Convention—Advertising Department Also Has Display

During the fifth annual convention of Edison dealers a special exhibit of New Edison phonographs was made in the West End Ballroom of the Hotel Commodore. The exhibit included a very complete line of the regular line models and also of the special Edison period models of the more expensive type. This exhibit was

conducted primarily for the benefit of dealers attending the convention, but was also open to the general public. Throughout Tuesday the exhibit room was well crowded, both with members of the trade and the general public. Among the brand new models of the New Edison which made their debut at this exhibit were the new Heppelwhite model at \$155, the new Sheraton Sans Inlay at \$195, the new Jacobean at \$250, the new Louis XIV, the new XVIII Century English (Adam) at \$450, the new Italian (Umbrian) at \$450 and the new Chalet table model at \$95. All these new instruments are very individual in design and are constructed on the same extremely high quality principles that characterize the entire Edison line. Another special room at the Hotel Commo-

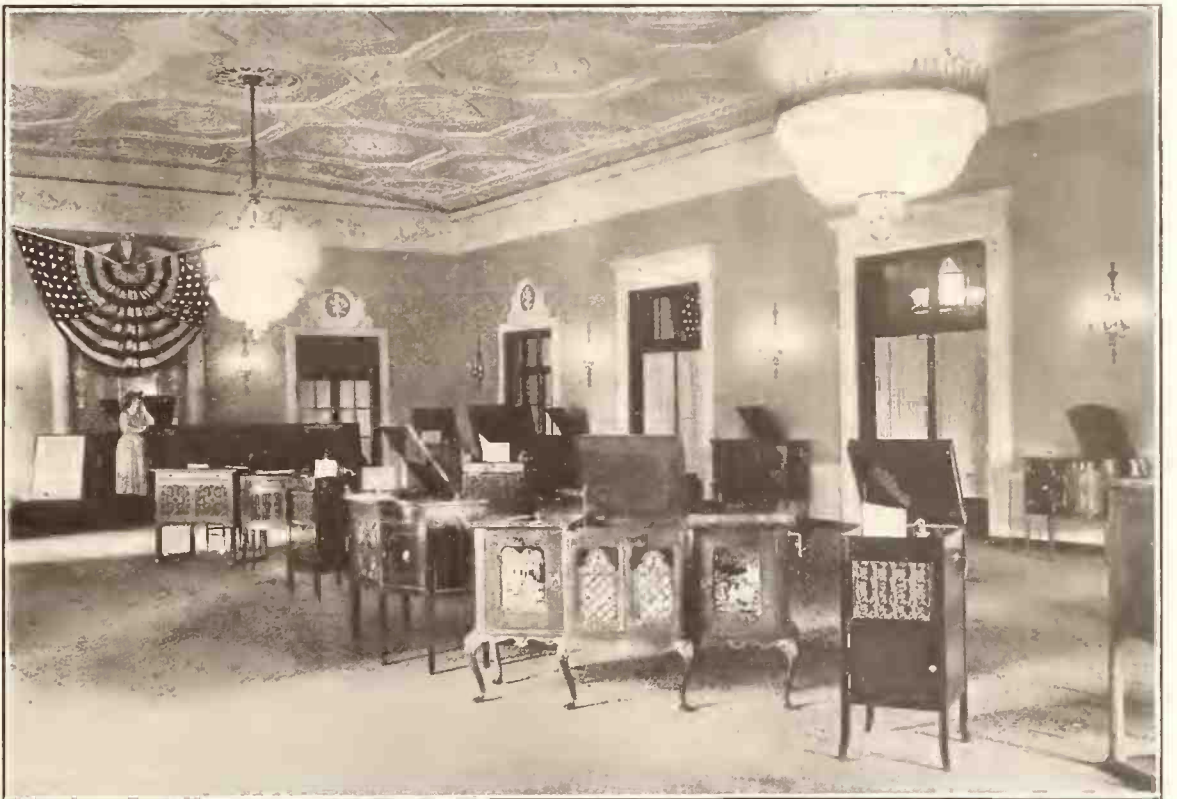

New Period Models Shown at Special Edison Exhibit—Miss Marie Tiffany in Background

dore was devoted to an exhibition by the advertising department of Thos. A. Edison, Inc. It consisted of a very comprehensive array of all the co-operative advertising, house organs, bulletins, display cards, Hansen window service, etc., that can be had by Edison dealers through headquarters at Orange. Needless to

say, this convention feature attracted much attention.

A brand new catalog entitled "Edison and Music" made its debut at the convention. It is very handsome typographically and contains artistic drawings of all the Edison instruments, including all of the various new models.

UDELL WORKS TO EXHIBIT

The Udell Works of Indianapolis have been making a good showing of their talking machine record cabinets and player roll cabinets on the north half of the second floor of the Klingman Building, Grand Rapids, during the great furniture exhibit that takes place in Grand Rapids annually each summer.

NEEDLE CUPS, TONE ARMS, MEISSELBACH MOTORS

Ask for our prices, lowest prices to quantity users. Ask for samples.



Immediate deliveries of this universal tone arm equipped with extra loud and clear sound box. Samples \$4.25. Ask for quantity prices.

MAIN SPRINGS

Following sizes in stock. Any other sizes to order.

- 1" x 0.20 x 13', for Victor, with oval hole, each..... 0.50
- 1" x 0.28 x 10', for Columbia each 0.50; per 100..... 45.00
- 7/8" x 0.23 x 10', each..... 0.38
- 3/4" x 0.22 x 10', Columbia, oval hole..... 0.35
- 3/4" x 0.25 x 9', oval hole, each..... 0.30
- 5/8" x 0.22 x 8', each..... 0.27

MICA DIAPHRAGMS

- 1-23/32", Victor Ex. Box, with or without center hole.....Each 0.15
- 1 1/8", for new Victor No. 2, very best, with or without center hole.....Each 0.18
- 1-31/32", for Sonora and all standard soundboxes.....Each 0.20
- 2-3/18", for Columbia No. 6, very best.....Each 0.25
- 2-0/16", for Pathé or Brunswick.....Each 0.45

SAPPHIRE NEEDLES

- Pathé, very best, loud tone genuine sapphire.....Each 0.27
- Pathé, soft tone.....Each 0.27
- Edison, very best, loud tone.....Each 0.27
- Edison, very best, medium tone.....Each 0.27

SUNDRIES

- Attachment for Victor Arm.....Each 0.25
- Attachuent for Victor Arm. permanent.....Each 1.15
- Kent Attachment for Edison Arm, nickel or gold plated.....Each 1.75
- Kent Attachment for Edison with Sound Box, nickel or gold plated.... 2.75
- Attachment for Columbia Arm.....Each 0.25
- Green turntable felt, 10" cut.....Each 0.10
- Green turntable felt, 12".....Each 0.15
- Governor springs, for Columbia motor.....Each 2c; per 100 1.00
- Governor springs, for Victor motor.....Each 2c; per 100 1.00
- Motor, double spring Meisselbach No. 12, complete.....12.50
- Motor, single spring, with 10" T. T., each..... 2.25
- Tone Arms, style P with mica box, each..... 4.25
- Soundbox, "M," fit Victor tone arm..... 1.00
- Columbia bevel pinion, No. 12333.....Each 90c; per doz. 9.00
- Columbia driving shaft, No. 11778.....Each 60c; per doz. 6.60
- Stylus Bar (needle arm) for Victor Exhibition Sound Box, complete, Each..... 0.35

FAVORITE PHONOGRAPH ACCESSORIES COMPANY, 1506 DeKalb Ave., BROOKLYN, N. Y.

EDISON TRAVELERS HOLD THEIR SECOND CONVENTION

Progressive Organization Met at Hotel Commodore on Last Month and Discussed a Number of Subjects Which Mean Much for the Future of the Industry—Close With Banquet

The second Edison Travelers' Convention was held in the West Ballroom of the Hotel Commodore on Tuesday, June 24. The morning session started at 10 o'clock with a brief word of welcome by T. J. Leonard. Following him Wm. Maxwell, as chairman of the meeting, made a talk on general matters which included several announcements of surpassing interest to the men present. M. M. Blackman, of Kansas City, next delivered an address on "The Laboratory Model," in which he outlined the importance of urging dealers to promote this model at the present time and how to do it effectively. An open forum followed directly after Mr. Blackman's talk. It was led by Messrs. Geo. C. Silzer, of Des Moines, Ia.; H. G. Anderson, Indianapolis, Ind.; A. R. Holbrook, of Cincinnati, O., and L. Taylor, of Ogden, Utah, by whom various suggestions were given.

E. E. Hammond, of New Orleans, La., next delivered an interesting discussion on "Canvassing." He outlined how important canvassing is to successful dealership, and how he persuaded the dealers in the Louisiana territory to adopt his belief. Following Mr. Hammond's talk an open forum ensued on the subject of canvassing which was led by G. F. Maxey, Detroit, Mich.; G. A. Sholes, Milwaukee, Wis.; O. M. Fisk, Kansas City, and O. A. Reynolds, of St. Louis, Mo.

W. L. Hightower, of Kansas City, Mo., was the next speaker and took as his subject "The Amberola Co-operative Newspaper Advertising Campaign," after which an open forum followed bearing on the Amberola, which was led by C. W. Hough, Omaha, Neb.; H. D. Stinchfield, Minneapolis, Minn.; J. K. Nichol, of Pittsburgh, Pa., and J. F. Tolleson, of Atlanta, Ga.

Following this J. G. Brown, of Syracuse, delivered an address entitled "Dealers' Quotas—What They Mean to Both Jobber and Dealer," after which followed an open discussion by O. P. Curry, Dallas, Tex., and C. H. DeForest, of New Haven, Conn.

The meeting then adjourned for luncheon but resumed activities again at 2.30, starting in at that time with a discussion by P. P. Hawley, of Albany, N. Y., on "Travelers' Reports." An open forum followed bearing on travelers' reports in which everybody participated. H. H. Blish, of Des Moines, Ia., then spoke on the topic of "Tone Tests: In What Respects Can the Present Scheme Be Improved?" The open forum which followed the "Tone Test" address was led by W. D. Word, Atlanta, Ga.; M. R. Kreuzsch, Cleveland, O.; T. A. Dillon, Toronto, Can., and L. A. Sutfin, Chicago, Ill.

J. K. Nichol, of Pittsburgh, Pa., spoke next on the subject of "Inspection Service: What Is the Dealers' Most Frequent Objection and How Do You Usually Meet It?" An open forum followed, headed by J. D. Gowdy, of Pittsburgh,

Pa.; G. C. Silzer, Sioux City, Ia.; P. P. Bassett, of Cincinnati, O.; J. Robinson, Philadelphia, Pa.

C. E. Stapleton, of New York, spoke next on "'Along Broadway,' and Other Laboratory Literature." The forum which followed was participated in by everybody. After that everyone took up the matter of new dealers-promotion plans with the result that many interesting and practical suggestions were made.

The meeting adjourned after having decided to hold the next Travelers' Convention at a time to be decided later.

Tuesday night those who attended the business session of the Edison Travelers' Convention were the guests of the Thos. A. Edison, Inc., at the Central Theatre, and enjoyed to the fullest extent the popular play, "Take It From Me."

Those who attended the convention were:

Albany—N. D. Griffin, P. R. Hawley.
Atlanta—W. L. F. Rosenblatt, W. B. Word, J. F. Tolleson.
Boston—F. H. Silliman, L. H. Ripley, G. R. Coner, F. S. Boyd, T. E. Dean, E. B. Compton.
Chicago—C. E. Goodwin, H. D. Buchanan, L. A. Sutfin.
Cincinnati—P. H. Oelman, A. R. Holbrook, P. P. Bassett.
Cleveland—B. W. Smith, L. N. Bloom, M. R. Kreuzsch.
Dallas—O. P. Curry, B. A. Ward, J. K. Paterson.
Denver—W. C. Wyatt.
Des Moines—G. C. Silzer, H. H. Blish, Jr., F. R. Williamson, E. C. Horne, H. F. Silzer.
Detroit—R. B. Alling, G. F. Maxey, M. E. Mikesell.
Indianapolis—W. E. Kipp, H. G. Anderson, E. H. Jarrard.
Kansas City—M. M. Blackman, W. L. Hightower, O. M. Fisk, F. E. Holmes.
Milwaukee—W. A. Schmidt, G. A. Sholes.
Minneapolis—L. H. Lucker, H. D. Stinchfield, G. H. Compton.
Montana—L. A. Walker.
New Haven—W. O. Pardee, F. T. Keeney, F. L. Stoddard, C. H. DeForest.
New Orleans—F. E. Hemenway, E. E. Hammond, A. Schreiber.
New York—E. C. Boykin, C. E. Stapleton, A. W. Toennies, W. E. Fredericks.
Ogden—R. Proudfit, L. Taylor.
Omaha—G. W. Shultz, J. M. Chapman, C. W. Hough.
Philadelphia—R. B. Cope, J. Robinson.
Pittsburgh—A. A. Buehn, J. B. Gowdy, J. K. Nichol, H. C. Trader.
Richmond—C. B. Haynes, E. Bowman.
San Francisco—A. Gabler.
St. John, N. B.—J. G. Harrison.
St. Louis—M. Silverstone, M. Goldberg, O. A. Reynolds.

BROOKS AUTOMATIC REPEATING PHONOGRAPH



THE WONDER INSTRUMENT

Plays and repeats any kind or size record—any desired number of times—then stops automatically with the tone arm suspended off to the right in the air. Any child can operate it.

WONDERFUL TONE WONDERFUL FINISH
WONDERFUL IN ITS SIMPLICITY
The Machine Creates Interest and Discussion.
It is Self-Advertising.

WONDERFUL SELLER
DEALERS—Send for Particulars, Prices, Terms
BROOKS MFG. CO., Saginaw, Mich.

Sioux City—G. U. Silzer, W. E. Morgan, R. W. White, O. W. Craik.
Syracuse—F. E. Bolway, J. G. Brown, C. L. and W. P. Eddy, H. D. Bush, A. W. Fiedler.
Toronto—R. S. Williams, H. G. Stanton, O. Wagner, T. A. Dillon, J. C. McKay, H. D. Cockburn, G. B. Petch.
Montreal—J. Arthurs.
Vancouver, B. C.—G. L. Bell.
Winnipeg—G. W. Paul.
Williamsport—W. A. Myers.
Edison Laboratory—Charles Edison, C. H. Wilson, W. Maxwell, T. J. Leonard, A. M. Hird, J. A. Shearman, V. E. B. Fuller, R. Michie, F. C. Pullin, K. R. Moses, E. E. Davidson, E. C. Trautwein, P. J. Burns, A. Rhinow, J. Van Riper, W. A. Reinhardt, H. R. Holmes, H. Durant, A. Walsh, H. R. Skelton, C. S. Gardner, J. J. Callahan, C. W. Burgess, W. F. Taylor, J. W. Scott, A. J. Palmer, C. H. Miller, J. P. Constable, G. C. Clark, E. H. Philips, D. Holden, W. Hildebrand.

The Stop That Stops Them All

An automatic stop of demonstrated success. Already in use by a number of Talking Machine manufacturers in this country and Canada, giving complete satisfaction. It always works—in short it is entirely dependable. Write for details.

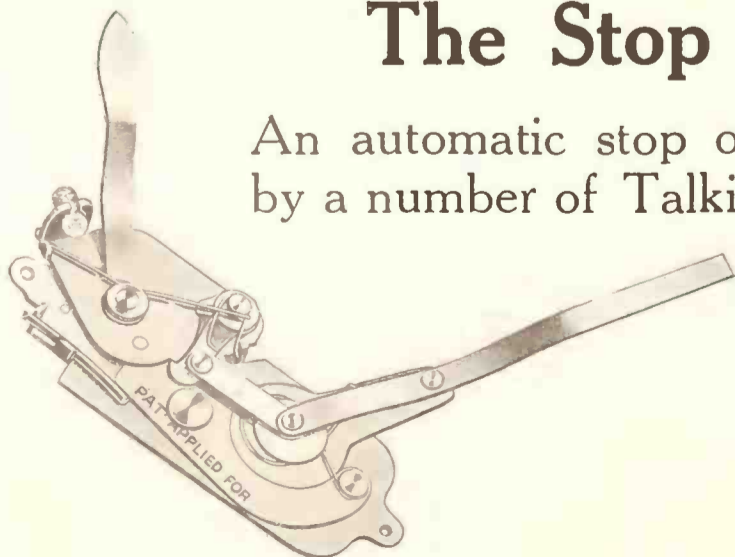

The Phonomotor Company

121 WEST AVENUE

ROCHESTER, N. Y.

CHARMAPHONE PHONOGRAPHS

Sold on a "QUALITY AND VALUE BASIS"

HERE IS THE LINE

For you to handle that will give you substantial profits

THE CHARMAPHONE'S splendid tone quality, attractive appearance and moderate price have made it the most popular Talking Machine on the market.

Order Today Samples of the CHARMAPHONE, and compare them with any high class machine. You will surely become a CHARMAPHONE dealer immediately.



MODEL 80-A.
44 in. high, 18 in. wide, 20 in. deep,
Heineman No. 33 motor, Heineman
Universal tone-arm and sound-box,
tone modifier, casters.
Wholesale Price \$40
Plus war tax
F. O. B. Pulaski, N. Y.



MODEL 35
12 in. high, 18 in. wide, 20 in. deep,
Heineman No. 36 motor, Charma-
phone Universal tone-arm and sound-
box.
Wholesale price \$17.50
Plus war tax
F. O. B. Pulaski, N. Y.



MODEL 65-A.
42 in. high, 18 in. wide, 20 in. deep,
Heineman No. 36 motor, Heineman
tone-arm and sound-box.
Wholesale Price \$32.50
Plus war tax
F. O. B. Pulaski, N. Y.



MODEL 55-A.
40 in. high, 18 in. wide, 18 in. deep,
Heineman No. 36 motor, Charma-
phone Universal tone-arm and sound-
box.
Wholesale price \$28
Plus war tax
F. O. B. Pulaski, N. Y.

The Best Popular Priced Talking Machine on the Market

The Charmaphone Company

Executive Offices and Showrooms

39-41 West 32nd Street, New York, N. Y.

We manufacture all our phonographs at our factory, Pulaski, N. Y.

—to score “direct hits” was the ambition of every battery in the A. E. F.

Emerson dance hits and song hits score “direct hits” with the music-buying public.



If you wish representation why not write today to our Vice-President, Mr. H. T. Leeming?

Emerson Phonograph Company, Inc.

NEW YORK
3 West 35th Street

CHICAGO
7 East Jackson Boulevard

VERY ATTRACTIVE UNICO MODEL DEPARTMENT INSTALLED

Interesting Feature of the First Floor of the Demonstration Building of the Victor Talking Machine Co. in Camden Is the Attractive Display of Unico Booths to Be Found There

PHILADELPHIA, Pa., July 2.—The Victor Talking Machine Co. have just installed on the first floor of their demonstration building in Camden a complete Unico model department as shown herewith. This was installed in order to demon-

strate to their dealers visiting the plant the value of efficient department layout and equipment. The department, occupying a space 28x60 feet, includes a display lobby, display windows, machine and demonstrating rooms, record sales room with record racks and counter, manager's office, and stockroom, which has all been com-



Unico Model Department Installed at Victor Headquarters in Camden, N. J.

pletely furnished and equipped. This department is designed and installed by the Unit Construction Co., and embodies the most advanced ideas in every detail and will undoubtedly prove of great value to Victor dealers in maintaining

a high standard of sales efficiency in their establishments.

During the past thirty days the Unit Construction Co. closed contracts with over sixty concerns in various sections of the country for the installation of Unico departments. The wide extent of these installations may be visualized by

the following partial list of recent installations: Eastern Talking Machine Co., Boston, Mass.; Clark & Jones, Birmingham, Ala.; Floyd's Music Shop, Paxton, Ill.; P. C. Peuser, Scranton, Pa.; Linton Co., Philadelphia; J. D. Harden, Sterling, Ill.; Bailey's Music House, Berlin, N. H.; Schultz & Schultz, Crawfordsville, Ind.; Earl Shepard Co., Klamath Falls, Ore.; A. O. Elliott, Savanna, Ill.; B. L. Conchar Co., Springfield, Mass.; G. F. Fields, Philadelphia, Pa.; W. H. Hill, Punxsutawney, Pa.; Redewell Music Co., Phoenix, Ariz.; Cable Piano Co., Wilmington, Ill.; Taylor-Moorehouse Co., Duluth, Minn.; E. T. Barron & Co., Superior, Wis.; Home Phonograph Co., St. Louis, Mo.; Union Outfitting Co., Omaha, Neb.; John H. Newell, Beverly, Mass.; F. G. Mardis, Mt. Vernon, O.; Van Wickle Piano Co., Washington, D. C.; C. L. Crowell, Leetonia, O.; S. E. Murphy, St. Cloud, Minn.; Cowperthwait Co., Brooklyn, N. Y.; Hadley Drug Co., Miami, Okla.; Thomas C. Watkins, Ltd., Hamilton, Ont.; Newton B. Heims, Pittsburgh, Pa.; Frederick Piano Co., Youngstown, O.; H. B. Newkirk, Salem, N. J.; C. A. Miller, Clyde, N. Y.; Maison Blanche, New Orleans; Music Lovers Shop, Rochester, N. Y.; Wilson Talking Machine Co., Oshkosh, Wis.; Schreve Studios, Boston, Mass.; Robert Clark, Osborne, Kans.; Leopold Adler Department Store, Savannah, Ga.; Cleveland Music Co., Beloit, Wis.; Donahoe & Donahoe, Fort Dodge, Iowa; William R. Zollinger & Co., Canton, O.

HELMUTH KRANICH, JR., RETURNS

After more than a year and a half service in the navy, Helmuth Kranich, Jr., son of Helmuth Kranich, secretary of Kranich & Bach, has been honorably discharged from the navy. During the latter eight months of his service Mr. Kranich was attached to the torpedo boat "S. S. Davis," which was on patrol duty on both this and the other side of the water. Before going into the navy Mr. Kranich was connected with the retail talking machine business.

GUARANTEED

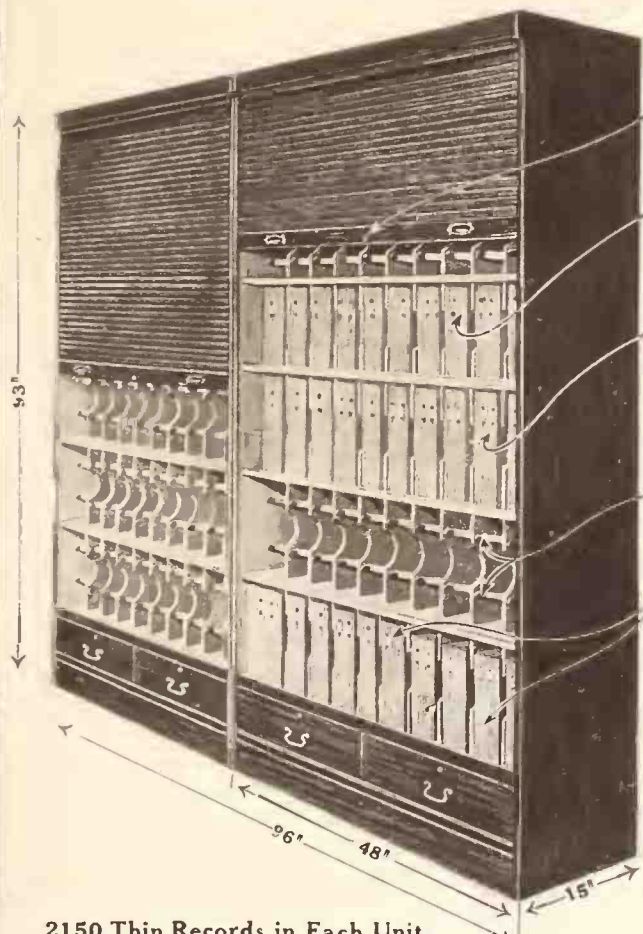

Locking Roll Top Prevents Dust and Theft.

350 10" Records on each shelf. Filed in Sales System Covers and Index Guides.

350 10" or 12" Records on this shelf.

Soft Flat Supporting Springs Prevents Warping (Patented).

10 and 12" Records Filed on same shelf. Held Flush at the front by Patented Adjuster.

2150 Thin Records in Each Unit.
4300 Records in These 2 Units Illustrated.

WRITE FOR CATALOGUE

Prices Models No. 2 and 62

(CAP. 300 10 and 12" RECORDS)

Sections	Oak \$6.00, Mah. \$6.25
Base	Oak 5.00, Mah. 5.25
Top	Oak 2.50, Mah. 2.75
Roll Curtain for complete Unit,	3.00

File Your Records So You Can Sell Them

This System pays for itself in six months. Automatically Re-orders All "Sold Out" Records. Every Record Located Instantly as Simple as 1-2-3.

PRICES, Models No. 2150 D. D. and L. C. (PATHE MODELS SPECIAL)

OAK	Locking Wood Roll Curtain	\$70.00
	Spanish Leather Roll Curtain	60.00
BIRCH MAHOG.	Locking Wood Roll Curtain	75.00
	Spanish Leather Roll Curtain	65.00

Sectional Models Fit Any Size Stock and Helps You Grow.



The Ogden Sales System Is Equivalent to an Extra Clerk and Increases Sales. Prices \$2.25 to \$9.75 a Section.

Ogden Sectional Cabinet Co., Inc.
LYNCHBURG, VA.



There are forty fox-trots to select from on this month's Columbia list.

Columbia Graphophone Co.
NEW YORK

INDUSTRIAL TENETS FIXED

Twelve Principles Indorsed by Referendum of American Employers

WASHINGTON, D. C., July 2.—Twelve principles of industrial relations have been indorsed by American employers, as represented in the membership of the United States Chamber of Commerce. Underlying the principle that "public interest requires adjustment of industrial relations by peaceful methods" were those declaring "the right of workers to organize," that "industrial harmony and prosperity will be most effectually promoted by adequate representation of the parties in interest," and that "industrial relations agreements should be faithfully observed." Fixing a basic day as "a device for increasing compensation" was held to be a subterfuge.

ALBERT SPALDING RETURNS

Albert Spalding, the noted violinist whose records made for the Edison have had such wide popularity, returned from abroad aboard the troopship "Dante Alighieri." During the war he served as an aviator and received his training in that branch in Italy. On the return trip he helped entertain the doughboys and delighted them by playing many selections. He made it a point to add his opinion that the war has done much for music and gave to the American soldier a better appreciation of the classics. While he is very much interested in aviation he is planning to return to the concert stage in the near future.

FINED WHILE GIVING SERVICE

C. J. Pott, Canadian Manager for Otto Heineman Phonograph Supply Co., Inc., Has to Say "Good Morning, Judge"

"Ten dollars and costs" adjudged the magistrate in a Toronto Police Court to C. J. Pott, Canadian manager of the Otto Heineman Phonograph Supply Co., Inc., who, when summoned before the "Beak," admitted that he might have been driving his car a little faster than the dizzy rate of fifteen miles per hour, which is the limit on Toronto streets.

"How can I give service at that speed?" counters Mr. Pott, who is more concerned about Heineman and Meisselbach products getting to the public via high-grade phonographs than he is in petty speed limits. In fact, his ear is so attuned to the rapid pace at the Heineman headquarters in Toronto that he just naturally goes over the speed limit.

NEW COLUMBIA DETROIT BRANCH

Manager Lind to Make Final Arrangements for New Branch in That City

S. E. Lind, manager of the Columbia branch at Detroit, is at present making final arrangements with the executive officers in New York for the equipment and arrangement of the new branch in that city. The new location of this branch will allow a larger operating space and has better shipping facilities which will ensure better service. The change in location is due to the increasing Columbia demand.

DEMAND IS MOST ACTIVE

Manager Bauer, of Cassidy & Co., Tells of Call For Victor Machines in Central New York

SCHENECTADY, N. Y., July 3.—The demand for Victor products in this city has been very great, with every indication that this exceptional demand will continue for some time to come. This highly encouraging report comes from Charles A. Bauer, the capable and aggressive manager of the Victor department of the Geo. A. Cassidy Co. Mr. Bauer, since his connection with the Victor department of the Geo. A. Cassidy Co. in 1911, has built a wonderful Victor business in Schenectady and his pleasing personality has won him a host of friends and made his department one of the foremost in the State. The general opinion of dealers in this section of the State is that Victor business has a very bright future in this section and all are planning to make the most of it.

RECENT INCORPORATIONS

The Jamaica Talking Machine Shop, Inc., Jamaica, L. I., has been incorporated with a capital stock of \$50,000 by C. Wischerth, A. Schwimm and A. H. Taylor, of Jamaica.

The General Phonograph Corp., of Illinois, has been chartered in Chicago with a capital stock of \$5,000. The incorporators are Henry F. Antos, Otto P. Lex and Otto B. Steiskal.

Wyman, Babb & Co., Chicago talking machine dealers, have opened a branch store at Chicago avenue and Leamington street.

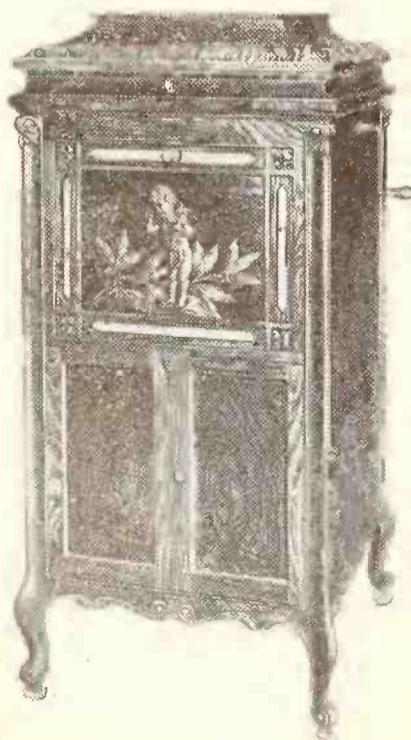

The Wonderful Tone Production of PHON D'AMOUR

is like the memory of a musician thinking over the performance of a great player. The

PHON D'AMOUR

plays every record and reproduces them tone true. This tone quality is obtained by the patented Diaphragm and Amplifier, which features are only obtainable in the

PHON D'AMOUR

THE FRITZSCH PHONOGRAPH CO. N. W. C. Main & Canal
CINCINNATI, OHIO

Announcing the

Steinburn

CHICAGO



Quality

unsurpassed and unsurpassable because side-by-side comparisons establish its obvious LEADERSHIP.

Tone

clear, rich, mellow music without even the slightest foreign vibrations. Steinburn LEADERSHIP is based on scientific improvements exclusively controlled by the Steinburn Corporation.

Popularity

assured by a policy of predominating national advertising and practical newspaper advertising wherever dealers are established.

Production

on a scale so large that accepted dealers will be assured deliveries.

Price

Large capital and no indebtedness permit us to establish retail list prices that give consumer 15% to 25% greater value.

Terms

four months acceptances without interest from date of invoice enabling the dealer to handle a far larger volume of business without using his capital.

Guarantee

a 5-year Guarantee Bond with each Steinburn phonograph assuring absolute consumer and dealer satisfaction.

Policy

one dealer in a locality but he must be a wake to the value of LEADERSHIP and able to retain it.

Model 40 Steinburn Phonograph.

50 in. high; 23 in. wide; 24³/₄ in. deep.
Finest selected veneers, genuine mahogany or quartered oak, golden or fumed. Extra heavy 5-ply panels. Finest hand finish.
Style F6, De Luxe tone arm, special precision weight adjustment for all records.
Steinburn orchestral reproducer—the very finest ever devised.
Steinburn all wood resonator with continuous curvilinear reflecting throat and two point support.
Improved non-muffling tone modifier.
Motor SC triple spring finest precision type.
Record compartment with shelves.
Automatic stop.



STEIN-BURN CORPORATION

General Offices and Display Rooms for Dealers
Heyworth Building, Corner Wabash Ave. and Madison St.

CHICAGO

More on next page

Announcing the

Steinburn

CHICAGO



ESTABLISHED merchants who appreciate the value of **LEADERSHIP** are invited to send at once for our catalog, or if possible to call personally at our Sales Office and Display Rooms for the purpose of seeing the Steinburn line and arranging for representation.

The Steinburn line comprises phonographs ranging in retail prices from \$32.50 to \$450.00 list.

Steinburn Phonographs play **all** records. The beautiful cabinets are made in Mahogany, Oak or Walnut.

The line has eleven distinctive models including popular cabinet styles, also period designs in Adam, Chippendale, Queen Anne, Louis XVI, and console models—each predominatingly superior.

The Stein-Burn organization has been successfully identified with large business interests of Chicago for forty years. For several years past we have been manufacturing phonographs of the better class. Our new policy of selling direct and exclusively to dealers assures the pre-eminence and leadership of the Steinburn phonograph. The securing of this line represents a franchise of unusual value to each dealer accepted.

Model 219 Steinburn Phonograph.

48 in. high; 21½ in. wide; 22 in. deep.
Finest selected veneers, genuine mahogany or American walnut—extra heavy 5-ply panels, very best hand finish.
Style 5B extra large balanced Grand Opera tone-arm and reproducer.
Steinburn all wood resonator with continuous curvilinear reflecting throat and two point support.
Improved non-muffling tone modifier.
Motor SAA large double spring of finest precision type.
Record compartment with shelves.
Automatic stop.



STEIN-BURN CORPORATION

General Office and Display Rooms for Dealers
Heyworth Building, Corner Wabash Ave. and Madison St.
CHICAGO

THE TRADE IN PHILADELPHIA AND LOCALITY

PHILADELPHIA, PA., July 5.—The talking machine business in this city is still finding the same great demand that has existed all through the year. The factories were able to supply more goods in June than they had done during the previous months of the year, and conditions generally are improving.

More Victor records and machines were received in June and it looks as if by late in the fall this firm will be in a position to supply a most satisfactory quota of the demand.

New Building For Columbia Co.

On Monday of this week the Columbia Grafonola started in to remodel the new building at Sixth and Filbert streets, which may be occupied by August 1. There will be 27,000 feet of floor space to lay out, which will be divided between the Columbia, which will move down from Broad street, and the Dictaphone, which will move over from Chestnut street, so that both establishments will be under the same roof.

Aside from the necessary offices, storage section, warerooms, etc., a handsome reception room for the trade will be built, and in the center of the second floor there will be a fully equipped talking machine salesroom, with all the necessary furnishings to be used as a model for dealers who wish to get a thoroughly up-to-date establishment. J. M. Bayliss, of the service department of the Columbia, is here working on the new building.

Columbia and Dictaphone Picnic

On Tuesday, June 10, the managers and employes of both the Columbia Co. and the Dictaphone Co. held an enjoyable picnic at Nesaminy Falls, near this city. Every one was there from Manager Wilcox down. There were plenty of good things to eat, and sporting contests of every character were held. There were several baseball games from pick-up nines of both com-

panies. There was a fat man's race, and this was won by Manager Wilcox, the prize being a handsome silk shirt, while the booby prize, a jumping jack, went to his assistant, H. E. Gardner.

A hotly contested egg race was also indulged in, and was won by D. S. Ramsdell, Mr. Westervelt leading until almost the finish, when he unfortunately dislodged his egg from the spoon and used it as decoration for his clothing.

Visitors to Columbia Offices

The Columbia Co. reports that business is improving right along, and the situation regarding machines and records is easing up materially. Among the Columbia visitors the past month were: H. L. Wilson, the general manager of the Columbia; R. E. Rea, who spent several days at the Philadelphia office; Calver Anderson, of Wilmington, Del.; R. L. Kieferle, a Columbia dealer of Lewiston; Mr. Youngjohns, of Norristown; S. N. Culver, of Delmar, Del., and H. Jarvis, of Millville, N. J.

Thomas J. Cummins, who for a number of years was head of the Strawbridge & Clothier talking machine department, has returned from France and has resumed his old place.

E. A. Manning, who contracted influenza last fall during the epidemic, has just returned to the Columbia, where he is the credit man.

Perfek'tone Co. Opens Warerooms

Philadelphia had a new firm added to its already long list in June, when the Perfek'tone Co. opened elaborate warerooms at 1127 Chestnut street. They have taken the entire building, which will be used for retail purposes. It has been elaborately furnished and all the case work of the Perfek'tone machines is of either reed or cane. The wholesale offices of the firm are located at the factory headquarters of Heywood Bros. & Wakefield Co., Fifth and Locust streets.

This firm represents the largest reed industry in the world, and the Perfek'tone machines are made at the Wakefield plant, at Wakefield, Mass.

New Edison Designs Popular

Herbert E. Blake, the biggest Philadelphia Edison dealer, reports that June was a most satisfactory month for him, although there was a shortage of machines during the month, due to the Edison Co. getting out a new line of period models which will be retailed by the dealers at from \$155 up.

Two Firms Enlarging

R. L. Perrett, of the Grafonola Shops Corp., is making extensive improvements in his warerooms at 1107 Chestnut street. He expects they will all be finished by the first of September. During the month he was in Boston attending a meeting of the store managers.

A large addition to the building of the W. L. Hurley Co., Camden, N. J., is nearly completed, and will be one of the finest in this vicinity. At the store, which is located at the corner of Broadway and Pine street, they handle the Brunswick, the Victor and the Edison machines. They have been advertising the Brunswick extensively.

C. P. Chew Again With Brunswick

C. P. Chew has again assumed full charge of the selling of the Brunswick in this territory, and he says that in all his experience he never saw dealers ordering machines as they are doing at present. The Brunswick machines are coming through much faster, and the factory seems to be catching up to the demand. They have a number of applications on file for the handling of the Columbia by big firms here, but they have refrained from putting on any new dealers until their present trade orders are filled. A. J. Kendrick, the sales manager of the Brunswick, was

(Continued on page 53)



A VICTOR DOG IN EVERY HOME

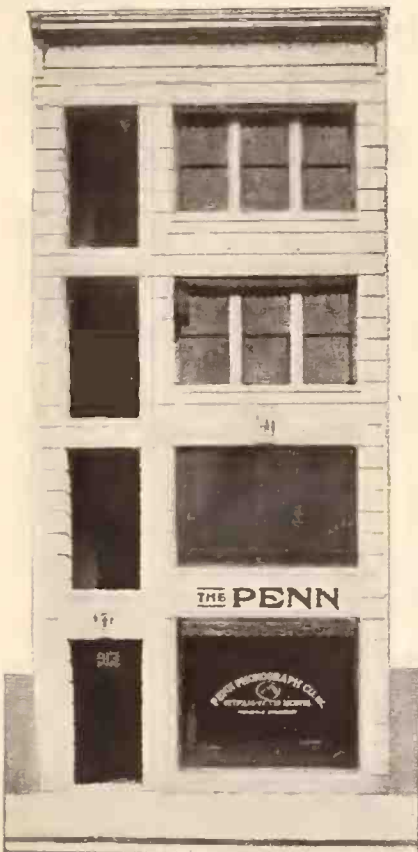

The Home of the Miniature Victor Dog

Permanent Advertisement

WANTED—Every Victor Dealer to provide a temporary home for the Plaster Paris Miniature Victor Dog. This miniature dog is the biggest permanent advertisement for the individual Victor dealer and the Victor business ever offered to the trade. Write for particulars and prices.

WANTED

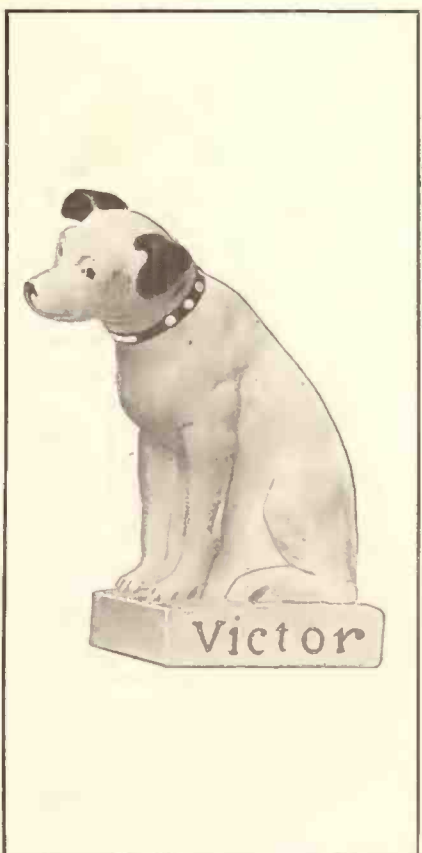

PENN PHONOGRAPH CO.
 913 Arch Street Philadelphia, Pa.
Victor Distributors Wholesale Only



BU EHN

SERVICE

WHAT are you doing?

Taking it easy—

- or insisting that July sales total April business
- planning a special August drive
- “polishing” your store equipment for Fall sales
- analyzing sales and creating quotas for September, October, November and December?

You ought to plan right now for the balance of 1919. This will be a banner year—that's sure.

The Louis Buehn Company

Victor Wholesalers

PHILADELPHIA



VICTOR

PHILADELPHIA

HITS! JAZZ! SONGS! BALLADS!

Recorded on **Emerson Records**

Attention!
Dealers in

Philadelphia
Eastern Pennsylvania
Southern New Jersey
Delaware
Baltimore
Washington, D. C.

What'll you have?

- 9184 { Everybody Wants the Key to My Cellar
Golden Wedding Jubilee
- 9198 { Blues My Naughtie Sweetie Gives to Me
I Ain't Got-en No Time to Have the Blues
- 9195 { Himalya
Oh How She Can Sing
- 1025 { Alcoholic Blues
Western Land
- 1020 { Kiss Me Again
The Magic of Your Eyes

AND—LOUISIANA FIVE'S best JAZZ pieces

Keep your cash register jazzing to the tune of Emerson Records by carrying a complete stock.

We have anything you want ready for immediate delivery.



Emerson Philadelphia Co.

Parkway Building

PHILADELPHIA, PA.

Broad and Cherry Sts.

Distributors of EMERSON RECORDS, IDEAL MUSIC ROLLS, BRILLIANTONE NEEDLES, and Albums.

in Philadelphia about the middle of the month, reporting good business.

Sonora Shipments Improving

E. S. White, Philadelphia jobber-manager of the Sonora, reports that machines are coming through in a much more satisfactory way. He says that the factory has promised the Philadelphia house substantial shipments in the near future. Mr. White was a recent visitor to Indianapolis.

Dogs, Fish and Mr. Barnhill

The Penn Phonograph Co. reports that business has been fair in June and that records have been coming through a little more promptly. Mr. Barnhill, who recently seems to have developed an unusual passion for animals, and especially the dog, is turning that penchant into good hard cash in the production of "His Master's Voice" in great quantities. On a recent visit I found a large aquarium of goldfish on Mr. Barnhill's desk, and have been wondering how they were to be used, but it must be for some commercial purpose.

Earl G. Dare Back With Penn Co.

Sergeant Major Earl G. Dare, who recently returned from France where he was with the 32d Division, has assumed his old position with the Penn Co. Recent visitors were C. N. Andrews, of Buffalo, N. Y., and J. W. Bridge, of Lock Haven, Pa., Leon Wittich, of the Wittich store, Reading Pa., K. H. Troop, of the Troop Music House, Harrisburg, Pa. The Troop firm is at present building a special record room, and will add several additional demonstration booths, making a total of fourteen.

Recent Visitors From Other Cities

George Gwehr recently visited this city and called at a number of different stores. He is making extensive alterations at his Wilmington, Del., talking machine store, which, it is said, will cost him \$40,000, and when completed will be the finest wareroom in this line in the State of Delaware. Mr. Holland, of the Roeblyn Piano Co., of Wilmington, was also here looking over the Philadelphia places to complete the plans

that he has already made for the improvement of his warerooms. H. E. Gardner, of the Columbia, recently spent several days among the firm's trade in Pennsylvania. A clever young woman talking machine representative, Miss Frankel, was in this city recently calling on the trade, representing the Sterling Talking Machine Co.

Riggins Piano Co. Opens

The Riggins Piano Co., also extensive handlers of talking machines, had the opening of their new store on July 1, where more than

double the former space will be given to the talking machine department.

E. E. Hipple, of the sales force of the Penn. has taken his family to Chelsea, Atlantic City, for the summer, and T. R. Clarke, of the same house, is spending the summer with his family at Pitman Grove, N. J.

"Shipments of Victrolas and records," says Harry W. Weymann, of H. A. Weymann & Son, "are showing considerable improvement

(Continued on page 56)

WEYMANN Victor Service.

WE aim to co-operate with our Victor Dealers in giving courteous and efficient attention to all inquiries and orders, and making prompt deliveries.

WEYMANN & SON

Victor Wholesalers

DISTRIBUTERS FOR QRS
PLAYER ROLLS

WEYMANN KEYSTONE STATE
STRINGED INSTRUMENTS

1108 Chestnut Street

Philadelphia, Pa.

Established since 1864

Pathé

YOU will make more money this year, next year and in the years to come with the magic name of *Pathé* over your store and the unequalled phonographs and records of *Pathé* in your store ready for the every day's growing demand for *Pathé* products than in any other field of endeavor.

YOU will never have as good an opportunity—perhaps opportunity will have passed out of your reach tomorrow—as you have today. *Pathé* dealers will not be crowded “off the map” and many are heeding the summons and taking advantage of the exceptional terms now being offered.

Write Nearest Distributor NOW

PATHE DISTRIBUTORS

PATHE FRERES PHONOGRAPH CO. (City Sales)
18 East 42d Street, New York

- | | |
|---|--|
| HALLET & OAVIS PIANO CO.,
146 Boylston St., Boston, Mass. | HARBOUR-LONGMIRE PHONOGRAPH CO.,
1001 Elm St., Dallas, Tex. |
| BRISTOL & BARBER
111 East 14th St., New York | HARBOUR-LONGMIRE PHONOGRAPH CO.,
311 W. Main St., Oklahoma City, Oklahoma |
| PATHE FRERES PHONOGRAPH CO.,
(City Sales Department)
18 East 42d St., New York City | THE FISCHER COMPANY
940 Chestnut Ave., Cleveland, Ohio |
| NATIONAL PIANO CO.,
305-307 N. Howard St., Baltimore, Md. | THE FISCHER COMPANY
44-46 Vine St., Cincinnati, Ohio |
| INTERSTATE PHONOGRAPH CO.,
1026 Chestnut St., Philadelphia, Pa. | CHURCHILL DRUG CO.,
Burlington, Ia. |
| PITTSBURGH TALKING MACHINE CO.,
963 Liberty Ave., Pittsburgh, Pa. | CHURCHILL DRUG CO.,
Peoria, Ill. |
| ROCHESTER PHONO. CO., INC.,
44 Clinton Ave. North, Rochester, N. Y. | CHURCHILL DRUG CO.,
Cedar Rapids, Ia. |
| BUFFALO WHOLESALE HARDWARE CO.,
317 Washington St., Buffalo, N. Y. | FULLER-MORRISON CO.,
540 W. Randolph St., Chicago, Ill. |
| WEAVER PIANO COMPANY,
York, Pa. | HELLRUNG & GRIMM,
904 Washington Ave., St. Louis, Mo. |
| M. SELLER & CO.,
Fifth and Pine Sts., Portland, Oregon | W. W. KIMBALL CO.,
Jackson & Wabash Aves., Chicago, Ill. |
| M. SELLER & CO.,
Spokane, Wash. | MOONEY, MULLER & WARD CO.,
101 S. Meriden St., Indianapolis, Ind. |
| WM. VOLKER & CO.,
Main, 2d and 3d Sts., Kansas City, Mo. | SALT LAKE HARDWARE CO.,
Salt Lake City, Utah |
| WM. VOLKER & CO.,
Houston, Texas | G. SOMMERS & CO.,
Park Square, St. Paul, Minn. |
| WM. VOLKER & CO.,
Denver, Colorado | WM. D. BROOKS & HINCHMAN SONS,
26 Congress St., Detroit, Mich. |
| ARMSTRONG FURNITURE CO.,
59 N. Main St., Memphis, Tenn. | WRIGHT & WILHELMY CO.,
Tenth & Jackson Sts., Omaha, Neb. |
| JOHN A. FUTCH COMPANY,
630 Washington St., Jacksonville, Fla. | WESTERN PHONOGRAPH CO.,
985 Market St., San Francisco, Cal. |
| GRAY & DUOLEY CO.,
Nashville, Tenn. | WESTERN PHONOGRAPH CO.,
820 S. Broadway, Los Angeles, Cal. |



Pathé FRÈRES PHONOGRAPH CO.

E. A. WIDMANN, President

10-52 GRAND AVE.

BROOKLYN, N. Y.

Pathe Freres Phonograph Co. of Canada, Ltd., Toronto

Pathé

Pathé sapphire—the beautifully polished round sapphire ball that fits perfectly into every record groove and flows over the surface of the record, reproducing accurately and smoothly the beauty of tone without it being marred by the scratching of the record-destroying hard steel needle.

Pathé sapphire—the crowning feature of **Pathé** **THE** Phonograph—makes the difference between music and mere noise—that is why **Pathé** has grown in such immense selling proportions during the last few years. **Pathé** dealers are reaping the benefits every day.



A Few New Best Sellers

- 22109 { "Sweet Hawaiian Moonlight".....Orpheus Trio
Accompaniment by Shebo's Novelty String Orchestra
- 22110 { "Lullaby Blues".....Premier American Male Quartet
- 22110 { "Eyes That Say I Love You".....Lewis James, Tenor
With Acme Male Quartet
- 22110 { "Alabama Lullaby".....Lewis James and Charles Hart
Accompaniment by Shebo's Novelty String Orchestra
- 22113 { "Chong"Premier American Male Quartet
- 22113 { "On the Ozark Trail".....Collins and Harlan
- 22114 { "Heart Breaking Baby Doll".....Billy Murray, Tenor
- 22114 { "Everybody Wants a Key to My Cellar".....Arthur Fields, Baritone
- 22118 { "Wild Honey"Toots Paka Hawaiian Troupe
- 22118 { "Till We Meet Again".....Toots Paka Hawaiian Troupe
- 40171 { "My Cairo Love"—Fox Trot.....Joseph Samuels' Orchestra
- 40171 { "Limbo-Land"—Medley One Step.....Joseph Samuels' Orchestra
- 22117 { "The Alcoholic Blues"—Fox Trot.....Synco Jazz Band
- 22117 { "Lassus Trombone"—One Step.....Synco Jazz Band
- 22121 { "I'll Say She Does"—Medley Fox Trot,
Green Brothers' Xylophone Orchestra
- 22121 { "Fluffy Ruffles"—One Step...Green Brothers' Xylophone Orchestra

Pathé FRÈRES PHONOGRAPH CO.

E. A. WIDMANN, President

10-52 GRAND AVE.

BROOKLYN, N. Y.

Pathe Freres Phonograph Co. of Canada, Ltd., Toronto

THE TRADE IN PHILADELPHIA

(Continued from page 53)

over previous months, and I am very optimistic over the prospects, and believe that conditions are going to be normal in a very short time."

Gus Pleibel, for many years connected with the Weymann talking machine department, recently returned from France and assumed his old position. John J. Powers, formerly at the head of the talking machine department of the George W. Huver Co., and who was in France for a year and a half, recently resumed his old post. A. P. Ackley, the talking machine dealer at 3161 Frankford avenue, is making extensive improvements in his store. C. G. Gardner, the Eastern supervisor of the Edison, was a recent Philadelphia visitor.

Eckhardt Takes Talking Book Agency

Walter Eckhardt, the jobber and retailer here of the Pathé, has just taken the agency for the distribution of the Talking Book Corporation's little "Talkers." His territory covers Pennsylvania, Maryland, Delaware, District of Columbia, North Carolina and Virginia. He has already placed these "Talkers" with the following firms: John Wanamaker, Philadelphia; Munger & Long, Camden, N. J.; Kauffman & Baer; Joseph Horne & Co., and Boggs & Buhl, of Pittsburgh, Pa., and the Schuldenfrei Dry Goods Co., of Atlantic City, N. J. R. S. Hibsman, who was recently with the Aeolian Co., has taken charge of Mr. Eckhardt's talking book department.

Mr. Eckhardt is at present very much engaged in the completion of a sales manual that he has been preparing for some time. It will give practical hints from a practical and successful dealer in talking machines.

Weymann & Son Add Music Rolls

H. A. Weymann & Son, well-known Victor and musical instrument distributors of this city, have found it expedient to add player rolls to their line. Many dealers on their list also carried music rolls and in the interest of efficiency and quick service H. A. Weymann & Son decided to make this addition to their stock. H. W. Weymann, who is in charge of this department, said: "The dealers will thus become identified with our three leading lines in their localities, all of which are of a quality that is indisputable. I look forward to fall with a most optimistic view and feel that the supply in all three lines will be greatly increased over corresponding months of last year." H. W. Weymann and family are spending the summer at Atlantic City, as usual, stopping at the Hotel Dennis.

Barnhill to Take Vacation

T. W. Barnhill, president of the Penn Phonograph Co., Victor wholesalers, will leave immediately after the Victor Distributors' convention is adjourned for a well-earned vacation, to be spent in New England.

Bevan Co. Installs Booths

The Bevan Co., of Wilkes-Barre, I am informed by the Penn, has entirely remodeled the present store and has installed seven additional booths.

COLUMBIA MEN BACK FROM FRANCE

D. V. B. Allen, formerly connected with the general sales department of the Columbia Graphophone Co., returned recently from France with the rank of lieutenant after fourteen months' service in the U. S. Army. Mr. Allen has resumed his connection with the general sales department.

E. B. Shiddell, formerly manager of the Columbia Co.'s branch at Dallas, who resigned to go overseas with the U. S. Army, returned from France this week as a lieutenant, bearing the insignia of the Croix de Guerre and the Victory Ribbon with two stars. Mr. Shiddell will probably resume his association with the Columbia sales division in the near future.

The Central Talking Machine Shop, New York, has been incorporated with capital stock of \$50,000 to manufacture talking machines.

TO REPRESENT AMERICAN MAKERS

William Gerner, of Chicago, to Visit Scandinavian Countries and Study Music Trade Conditions There for American Interests

CHICAGO, ILL., July 2.—William Gerner, for over thirty years a member of the Chicago piano trade, leaves Thursday of this week for New York, whence he will sail within a fortnight for a four months' European trip, a greater part of which time will be spent in Norway, Sweden and Denmark. The trip is taken with a view to studying conditions in the music trades of these countries and other European States in order to open them up for American-made pianos, players, organs, phonographs, music rolls, cabinets, benches and specialties. Mr. Gerner, himself a native of Norway, has already taken several trips to Scandinavia and in the past has done considerable export business. He is now entering this field on a permanent basis and expects to promote American trade with Scandinavia and vice versa. He will have associated with him his son, William Ger-

ner, Jr., who recently received his discharge in France after sixteen months' active service with the A. E. F., and who is now visiting the music dealers abroad. While in New York Mr. Gerner will interview manufacturers with a view to obtaining representation of their products. His address while in that city will be the Swedish-American Chamber of Commerce. His foreign office will be 1 Graensen, Christiania, Norway, and the American office is 4909 Broadway, Chicago. A comprehensive system of export service has been devised.

BOOKED GOOD ORDERS ON TRIP

Fred S. Solton, of the sales staff of the New York Album & Card Co., has just returned from a five weeks' trip throughout the trade. This was Mr. Solton's first trip after his return from service abroad. He was well pleased with the reception given him by his old friends in the trade, which took tangible form in the volume of orders received. Mr. Solton found business conditions very good throughout, and was impressed with the recent growth of the trade.

The FRANKLIN

The Phonograph That Stays Sold

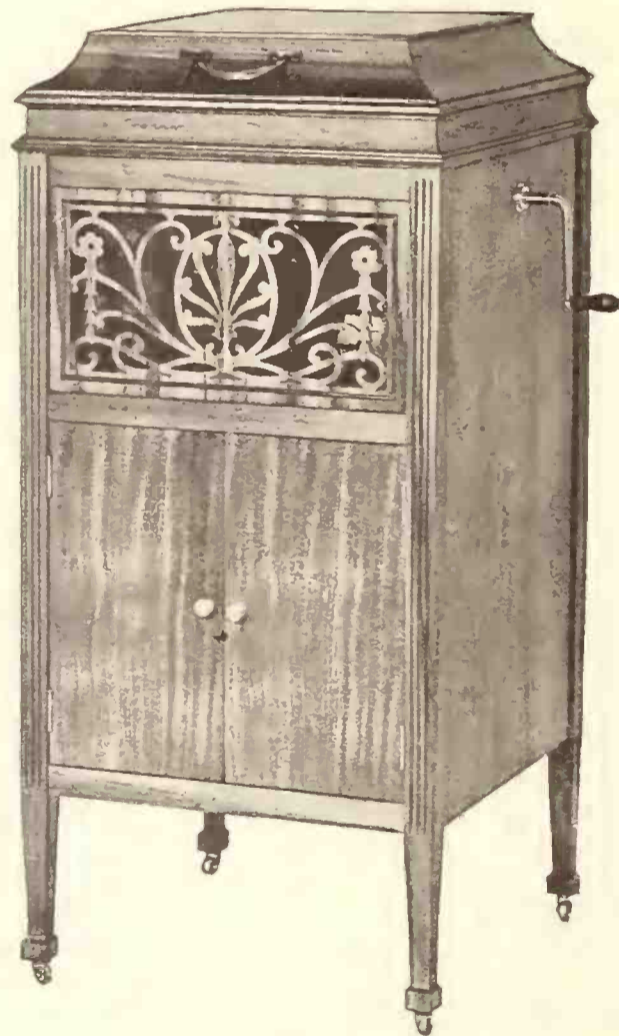

ADAM, \$125

Like a good watch, the vital thing in a phonograph is its works, the motor must run true, and, above all, the Reproducer, Tone Arm and Horn must be balanced and of the best quality.

We invite Comparative Tests as to the tone value of the Franklin.

Ten styles from \$50.00 to \$700.00.

Let us send you a price list, or, better still, order a sample at once.

The Franklin

is different.



FRANKLIN PHONOGRAPH COMPANY

INCORPORATED

10th & Columbia Ave.

PHILADELPHIA, PA.

**The public wants today's dances today.
And that's what they get on Columbia
Records.**

**Columbia Graphophone Co.
NEW YORK**



TRADE CONTINUES VERY BRISK THROUGHOUT OREGON

Victory Rose Festival an Event of Last Month—Big Demand for Victrolas—Wiley B. Allen Operations—Dealers Placing Heavy Orders for Fall and Winter Demands—Other News

PORTLAND, ORE., July 5.—The Victory Rose Festival was the important event of last month in this city. It rather interfered with the business of the talking machine houses during the three days when the parades occupied the attention of the thousands of visitors who crowded the streets, but the after-effects of the festival were stimulating to the summer trade.

Charles H. Carder, of the Victrola department of Sherman, Clay & Co., has had orders for Victrolas from as far east as eastern Pennsylvania, orders which it has been impossible for him to fill on account of the shortage of stock. A firm in Crown Point, Ind., wrote to him and asked him if he could fill an order for them in twelve months, but Mr. Carder was absolutely unable to give them any assurance that the order could be filled even then. The demand in Portland and surrounding country for Victor machines is increasing.

Extensive alterations are being made in the Wiley B. Allen store. The record department will be put on the floor in which the shop is now located and this will make that department one of the largest and most complete on the Coast. Frank Case, manager of the local house, says that everything will be done to increase the efficiency of this department and make it comfortable and pleasant.

Paul B. Norris, manager of the Wiley B. Allen talking machine department, has made more than his usual number of big sales during the month of June. A good stock of machines and a fine supply of records is on hand.

The G. F. Johnson Piano Co. is extensively advertising the Cheney phonograph. Cheney style 1 is the big seller of the summer season. It is in great demand for dancing, and its popularity increases every day.

The Remick Song Shop has such pleasant well-ventilated demonstration rooms that many of the young people who visit this store for the purpose of buying sheet music go into these rooms and buy Columbia records. The new venture of the Remick Song Shop is well looked after by Mrs. Frances Powell.

L. D. Heater, of the Columbia Graphophone Co., reports very satisfactory business. The dealers are calling for the L-2 Columbia, a \$225 instrument, which is a sensational seller. Mr. Heater says there is an extraordinary demand for big machines, although vacation models are wanted at present. The dealers here have been seriously handicapped by not being able to furnish these small models, which are so desirable for automobile trips, campers, and so forth.

A big shipment of records, including a fine assortment of foreign records, has just been received at the Columbia Grafonola shop.

Miss Reils, in charge of the record department of the Reed-French Co., has made some good sales during the month.

George W. Haskins, of the Burmeister & Anderson Co., Oregon City, Ore., who are dealers

in Columbia and Edison phonographs, was a recent visitor.

A shipment of thirty-two Brunswick machines has just been received by the Wakefield Music Co.

The G. F. Johnson Piano Co. have a very handsome new sign in front of the entrance on Sixth street. The famous Victor trade-mark forms the upper portion of the sign, the word Victrola being shown in large letters beneath the firm's name. It is a double sign and equipped with flashes so that the sides are alternately light and dark.

H. E. L'Anglaise, of the Remick Song Shop, is in Portland at present getting Columbia stock for the Wade fibre needle cutter.

Taylor C. White, 309 Stock Exchange Building, exclusive jobber in talking machine accessories, is making a phenomenal success with his entire line. He has just closed a deal whereby he becomes the exclusive jobber for Oregon, Washington, California, Idaho and Montana for the Wade fiber needle cutter.

G. C. Cook has become sales manager for the Taylor C. White line. Mr. Cook is making a tour of the Coast States.

The Wax-Wilson Co., which is the distributor for the Tone-Clear, is having splendid success in handling the record cleaner and renewer.

It has just sold one concern in San Francisco \$10,800 worth of the article.

Foley & Van Dyke are very fortunate in having a goodly stock of small machines on hand, which are in such demand during the summer months. Mr. Foley said that they took the advice of Frank McGallaird, representative of the Victor Co., who visited Portland a few months ago, and bought pretty heavily of small Victor machines.

Calef Bros. are placing very interesting advertisements in the local papers calling attention to the Pathé phonograph.

A new index card system has been devised by E. B. Hyatt, of the Hyatt Talking Machine Co. All of his assistants are enthusiastic over the new method, which is a big improvement over any system formerly used.

M. W. Davis, manager of the Edwards Furniture Co.'s talking machine department, is one of Portland's best salesmen. He has sold a goodly number of small machines for camping and outing trips and in three days' time sold in addition five \$200 Brunswicks, and a \$225 Brunswick, and at present writing there is not a \$200 Brunswick in stock.

The talking machine department of the Bush & Lane Co. continues to grow in popularity. More cash sales than usual have been made the past month.

Keenan & Jahn, Detroit, Mich., have opened a new store devoted exclusively to the display of talking machines and records.



**Iowa, Nebraska
and Wyoming Dealers**

The "Dusonto Phonograph" gets the *best* out of all makes of records. That is why the "Dusonto" is the "Master Key of the Record."

Immediate deliveries can be made to dealers in this territory through

THE BRINSMID CO.

Des Moines, Iowa

Exclusive Distributors for Iowa, Nebraska and Wyoming.

When dealing with "Dusonto" distributors you are assured of prompt, efficient and courteous service at all times.

Send for details.

The Belcanto Company, Inc.

2007-B Bush Terminal Sales Building

130-132 West 42nd Street, New York



The
Scotford Tonearm
and
Superior Universal
Reproducer

The Ideal
Combination
Plays All Makes of Records
as they should be played

Price of Sample Prepaid
Nickel, \$6.25 Gold, \$7.75
Adjusted for Cabinet
measuring 8 1/2 inches from center of Tonearm
base to center of Turntable shaft

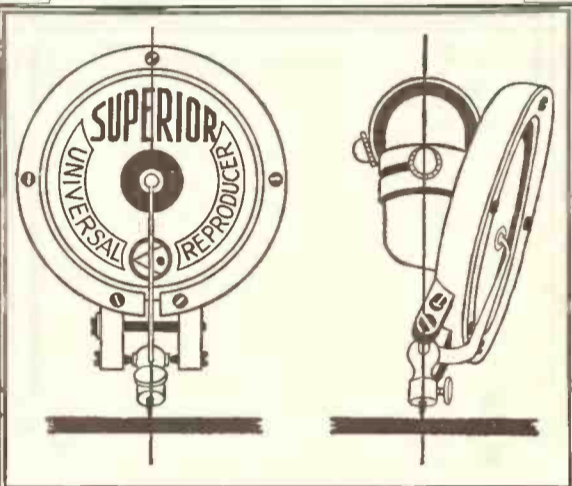

Distinctive Features

The Reproducer pivots on its axis (as illustrated above), taking the correct angle for all makes of records, and the needle retains same center in both positions.

Surface noise is less than with any other reproducer—surface scratchings being reduced to a minimum through perfect proportioning of the stylus construction, and placing the needle in the center of the groove at the correct angle.

The split construction of the frame and face ring of the Reproducer, together with the method of pivoting the stylus bar, and perfect insulation—effect a sensitive and free vibration—and prevent a pinched tone resulting at any time from natural contraction or expansion of the metal parts.

The reproduction is the mellow, natural quality of tone—absolutely getting away from the usual sharpness and metallic effect so noticeable in most reproducers.

Sound waves act upon the same principle as light waves—they travel in a straight line until they meet some obstruction, from which they are deflected at right angles. The right angle turn at the back of the Scotford Tonearm causes less breaking up and confusion of the sound waves than occurs in the curved arm.

The connection between the Reproducer and Tonearm is perfectly insulated with a hard rubber bushing. Inside diameter of the Tonearm is correct to accommodate the volume obtained from the latest records.

The right-side turn for changing needle is handier than the old style turn-back, and when in position for the Hill-and-Dale records there is no interference with lowering the cabinet cover.

The lateral movement at the base is simple, free and permanently satisfactory. Inside there is no obstruction to interfere with passage of the sound waves. There are no loose balls in the bearings, therefore no buzzing noise can occur from the great vibration on high notes.



Barnhart Brothers
& Spindler

Monroe and Throop Streets—Chicago

TALKING MACHINE MEN, INC., MEET

Plans Completed for Strong Membership Drive
—Join National Association of Music Merchants—New Service Bureau Working Well

At the monthly meeting of the Talking Machine Men, Inc., the organization composed of talking machine dealers of New York, New Jersey and Connecticut, held on the 18th day of last month, a full report of the plans for intensive campaign for membership which starts to-day (July 15) was presented.

The campaign will open with a luncheon at the McAlpin Hotel, where the membership teams and the dealers will be addressed by George W. Pound, general counsel and manager of the Music Industries Chamber of Commerce. The drive for new members will end shortly before the annual outing of the association, which is scheduled to take place at Rye Beach August 13.

E. G. Brown, secretary of the association, reported on his trip to Chicago early in June, when he was authorized to join the Music Industries Chamber of Commerce. This the organization accomplished by affiliating with the National Association of Music Merchants, who are already represented in the chamber.

J. J. Davin, who has been taking an active part in the membership drive as well as in the new service bureau of the association, spoke for both committees. In the report on the new service bureau he showed that in many ways they were compiling data, etc., which will be most helpful to the dealers making use of the material. The committee will also enlist the services of Ed Usoskin and Otto Goldsmith. The former is already supplying much material to dealers through his sign service organization and the latter makes a specialty of jobbing in special accessories and materials for dealers.

The membership committee was authorized to have a button made containing the names of the individual dealers of the association, these to be worn at meetings and outings as a means of recognition, as well as to encourage the dealers to make the acquaintance of all the members of the association. This plan is followed by the Rotary Club and other organizations and is a good idea.

ISSUE THEIR INITIAL CATALOG

GRAND RAPIDS, MICH., July 1.—The Grand Rapids Phonograph Co. of this city have issued their initial catalog to the trade. The book has been very attractively and artistically produced and the engravings portray realistically the nine models constituting the entire line. Five of the models are of the upright type and four of the Console type. All are in period designs, and the periods used are Chippendale, Louis XVI. Queen Anne, Adam and Sheraton.

BACK ON PEACE BASIS

Harry B. Haring has joined the general sales department of the Columbia Graphophone Co., but has not yet been given a definite assignment. He was formerly with the Fourth New York Infantry and was later captain of a machine gun company, and saw several months' service with the A. E. F. in France.

TALKING MACHINE DEALERS

—READ THIS—

"The finest and most delicate pieces of mechanism do not prove efficient unless properly lubricated. Skill, Genius, Invention and Workmanship must have the proper Oil. Stop and consider this when you have to buy an Oil for household use."

NYOIL
IS BEST

FOR ANY TALKING MACHINE



Being made in our Watch Oil Dep't, the same care given in refining as in our "Watch Oil," as all gums and impurities are extracted, leaving it Colorless, Odorless and Stainless.

BEWARE OF SCENTED OILS

Machines will not clog if oiled with NYOIL. NYOIL is used by the U. S. Gov't in Army and Navy. A trial order will make a permanent customer of you.

Ladies use NYOIL for Sewing Machines, for it is stainless. Sportsmen find NYOIL best for Guns, for it keeps them from rusting.

NYOIL is put up in 1oz., 3 1/4 oz. and 8 oz. Bottles, and in Pint, Quart and Gallon Cans.

For Sale by all Talking Machine Supplies Dealers
WILLIAM F. NYE, New Bedford, Mass., U. S. A.

NEW SONORA PERIOD DESIGN SHOWN

Italian Renaissance Model One of the Handsomest in Entire Sonora Period Family

Perhaps one of the handsomest of the Sonora Period family, namely, the Italian Renaissance Sonora, has just been brought to the public at-



Sonora Italian Renaissance

tention. This Italian Renaissance model is remarkably beautiful in both lines and in color. Due to the fact that furniture of this period is in vogue at this time, such a model is unusually timely. The cabinet will be forty inches high, twenty-six inches deep with a width of forty-six inches. It will be finished in oak and walnut, and all exposed metal parts are of antique gold finish. The Sonora phonograph quality is brought to its highest development in this model and the usual Sonora features, such as the motor meter, the tone arm and the tone modifier, are used in connection with it.

Jazz records are big sellers with the Culp Bros. Piano Co., Inc., Fort Smith, Ark.

"MAGNET" DECALCOMANIE NAMEPLATES



FOR TALKING MACHINE
CABINETS ETC

Pamphlets with fac-simile illustrations and prices mailed on request.

SMITH-SCHIFFLIN CO.

126 Liberty Street New York City



SOLD BY
WALTER D. MOSES & CO.
Oldest Music House in VA and NC
103 E BROAD STREET
RICHMOND, VA.

SOLE BY
J. E. STRATFORD
AUGUSTA, GA.

Jealous! Ambitious! Selfish! Proud!



GUILTY? Yes! Guilty on every count, and, what's more, we glory in it because back of it all is a Big, Generous, Impelling Motive.

JEALOUS of what others have done—AMBITIOUS to do more. SELFISH lest we may not do most—yet PROUD of what we already have done for the betterment of the TALKING MACHINE INDUSTRY and for the joy of phonograph users the world over. *What have we done?*

We Have Given to the World

The Universal Talking
Machine Needle Supreme!

“Tonofone”

The Semi-Permanent
Needle That's Different

THE NEEDLE WITH THE WONDERFUL TONE-PRODUCING ELASTICUM TIP

“Tonofone” tip is plastic—not hard and harsh. It is elastic—not stiff and rigid. It is pliable—not brash and brittle. It is cylindrical, of correct diameter and blunt pointed—not tapered and sharp. Therefore it will not widen with use nor scratch like other needles. That's why each Tonofone plays 50 or more standard records without injury.

ITS TONES ARE MARVELOUSLY PURE!

“Tonofone” is not a loud needle, but brings out all the tone-value of the record without the scratch. It does not sacrifice the tone quality for the sake of volume. It is the “needle of quality.”

ITS ARTICULATION IS AMAZINGLY CLEAR!

“Tonofone” tip being plastic and elastic, quickly shapes itself to the groove and picks out every one of those wonderful microscopic sound waves, thereby giving a perfect reproduction which no needle of any other construction can do.

OTHERS MAY IMITATE—NONE CAN DUPLICATE!

“Tonofone” makes the talking machine all but human—makes it sing and talk just like the human voice—makes it play instrumental music like the instruments themselves in master hands.

IT MAKES ALL RECORDS BETTER! IT MAKES GOOD RECORDS GREAT! IT IS THE “MASTER NEEDLE”!

“Tonofone” is not an experiment—it has stood every known test. Musically, mechanically and scientifically, it is correct. It has set a new standard in “Phonography.”

DISTRIBUTORS

- The Reed Company
237 Fifth Avenue, Pittsburgh, Pa.
- Home Music Co.,
9 No. Queen St., Lancaster, Pa.
- Smith Bros.,
Sandusky, Ohio.
- World Phonograph Co.,
Chicago.
- W. A. Carter,
Cable Building, Chicago.
- The OkeH Record Distributing Co.,
OkeH Bldg., Grand Rapids, Mich.
- World Sales Corporation,
1340 Lawrence St., Denver, Colo.
- Walter S. Gray,
Chronicle Bldg., San Francisco, Cal.
- M. D. Swisher,
115 So. 10th St., Philadelphia, Pa.



“Tonofone”
MADE SUPREME BY
THE MAGIC TOUCH
OF A FAIRY'S WAND

If You
Make or Sell
Talking Machines
or Records You
Need “Tonofone”

SNAPPY
PROPOSITION,
NOW READY
“COME AND GET IT”

EASTERN AND EXPORT DEPT.
180 BROADWAY
NEW YORK CITY
U. S. A.
TEL. CORT. 8586

MADE for THE TRADE by
R. C. WADE CO.

HOME OFFICE AND FACTORY
110 SO. WABASH AVENUE
CHICAGO, ILL.
U. S. A.
TEL. RANDOLPH 2045

The
CHENEY
 PHONOGRAPH

IN DESIGN, workmanship, choice of woods and finish Cheney Phonograph Cabinets are equal to the old world masters of period furniture design.

Sheraton and Hepplewhite, and those craftsmen of the William and Mary, Georgian and Queen Anne periods, live again in masterful Cheney creations.

We offer Cheney Phonographs in Regular and Console models, and create Art Models to suit individual requirements.

Cheney Cabinets are matched only by the Cheney Tonal System which they enclose. A series of *acoustic inventions covered by basic patents*, keep Cheney Tones serenely pure, comparable only to the original production.

On Display

at the

Grand Rapids Market

Keeler Building Arcade

June 23—July 19

Cheney Talking Machine Company

831 Marshall Field Annex Building
 24 North Wabash Avenue
 Chicago, Illinois

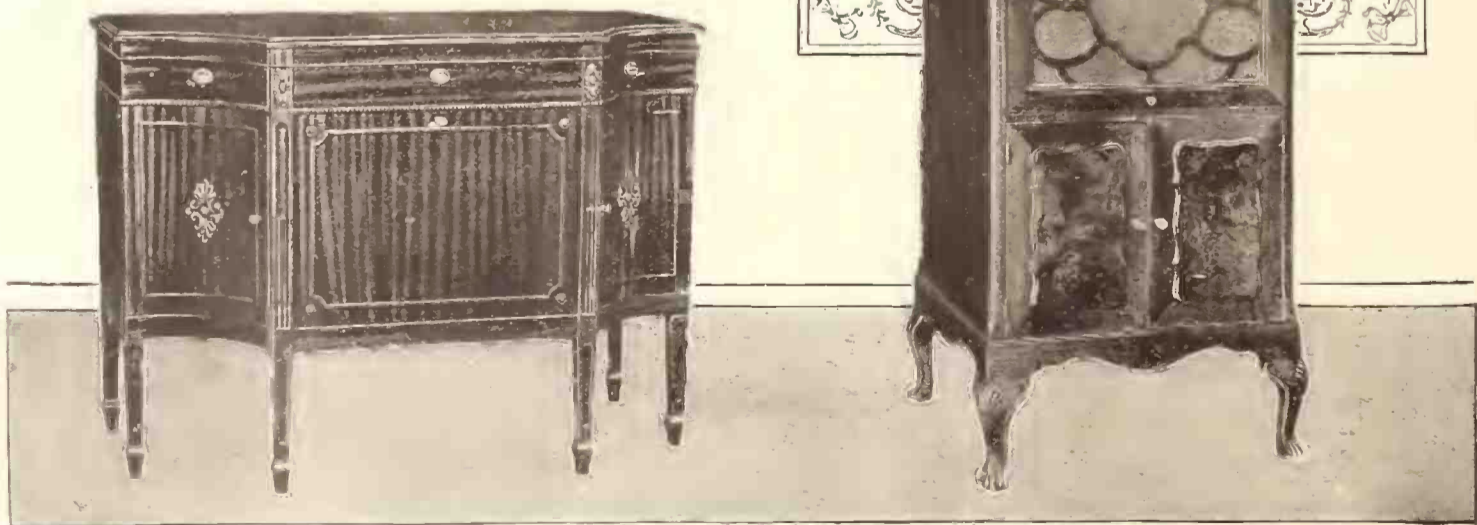

THE TRADE IN BOSTON AND NEW ENGLAND

JOHN H. WILSON, MANAGER, 324 WASHINGTON STREET, BOSTON, MASS.

BOSTON, MASS., July 3.—These are the days when business is expected to let up; no establishment looks for a serious drain on its line of machines or of records, although the shore and mountain business that has been developed the past few years has been surprisingly great. Machines that are especially popular are the lower priced ones, such as are adapted to camps and canoes, and to-day there is scarcely a lake or river resort where one will find a canoe without a machine. One hears of splendid prospects, and big ones, too, that will materialize in the fall, for good business is in the air. It is the lucky and businesslike dealer that plans now to place his fall order for goods, for there promises to be a shortage for those who are not early in the field.

Death of Russell L. Steinert

Robert S. Steinert, head of the Arch street Victor Department of the M. Steinert & Sons Co., has had the sympathy of a large circle of friends in the trade in the loss by death of his elder brother, Russell L. Steinert, president of the Jewett Piano Co., and associated also with the Steinert house. The young man while at a family outing dived into shallow water and hit his head on the bottom, so injuring himself that he died the following day at a hospital. Russell Steinert had been in business only a few years, following his graduation from Dartmouth College in the class of '12, and he had a most promising career before him.

Aeolian-Vocalion Forces Hold Picnic

The Boston Chapter of the Aeolian-Vocalion Co. held a picnic at Norumbega Park the last Saturday in June, and it was "some party." Manager T. W. Hindley was insistent that everybody should have a good time and between sports and dancing and canoeing and a good

supper the company spent a pleasant afternoon and evening. In fact, so well pleased were all the members of Manager Hindley's staff that they may get together again at some resort before the end of the season. This organization, which was started less than two months ago, is accomplishing all that was bespoken for it, and it is developing a fine esprit de corps among all the employes.

Signs Up Many New Dealers

Manager Oscar W. Ray, of the Emerson New England, reports that the new 10-inch record just introduced has been a good seller from the start, and dealers are eager to get a large supply of them. Mr. Ray has lately been over in New York and Bridgeport, Conn., this trip being taken in part in connection with the company's plan to develop an international and foreign business for its product, and already 100 accounts have been opened throughout the New England territory. The Metropolitan Furniture Co. in Springfield, Charles F. Boardman in Gloucester and I. F. Corinha in Woburn are some of the new dealers who have lately been signed up.

M. C. Perkins in Partnership With Brother

One of the important changes to be announced this month is the resignation of M. C. Perkins, the right-hand man to Manager Fred E. Mann at the Columbia wholesale headquarters. Mr. Perkins, who has had a long and valuable connection with this company, has gone into partnership with his brother, A. M. Perkins; and the Perkins Music Store, located in the Auditorium Building, Malden, is the result of the combination. This new store was briefly referred to in this department last month, at which time it had been in operation about two weeks. In the meantime the Columbia busi-

ness has been coming along at such a rate, for this is exclusively a Columbia store, that Mr. Perkins felt obliged to give all of his time to the enterprise much sooner than he had expected. Mr. Perkins was six years with the Chambers street, New York, quarters of the Columbia, and thereafter until coming to Boston he was manager of the Springfield store. Mr. Perkins has made many friends in Boston and both office employes and dealers will miss him greatly; but all are wishing him the best of success.

To succeed Mr. Perkins, Fred R. Smith has been brought over from the New York offices, where he has been well trained in the particular line of work he is called upon to take up here. Mr. Smith is a brother of Assistant Manager Smith, of the Pittsburgh offices of the Columbia. He reached Boston about the middle of the month.

Manager Mann, of the Columbia, spent considerable time the middle of the month in an inspection tour of the various Columbia agencies in Massachusetts and southern New England. He returned to Boston with a new fund of enthusiasm not only for the Columbia dealers, but for the volume of present business done and the fine prospects for the late summer and fall.

Showing New Vocalion Model

A new Vocalion model, No. 620, which will be included in the fall catalog of the company, is being shown at the Boylston street warerooms of the Vocalion and is being well spoken of by those who have examined into its merits. The handsome fivefold screen, "The Siren of Music," which attracts so much attention as the background for the Vocalion's window dis-

(Continued on page 62)

A Part of Your Daily Life

"New England Service for New England Dealers"



MORNING and night—and frequently at noon—you think of Eastern Service.

IN fact it is part of your daily life. To make your business better is our chief aim.

AS our interest is primarily in your welfare our staff believes that your improved success is the basic cause of our continuous growth.

The Eastern Talking Machine Co.

Victor Wholesalers

85 Essex Street

BOSTON

THE TRADE IN BOSTON AND NEW ENGLAND—(Continued from page 61)

play, is the work of Miss Edna Tremaine, of the Normal Art School.

A. E. Russell, of the Vocalion staff, recently spent a half-day studying the intricacies of the Vocalion laboratories and another half-day making a similar visit to the Columbia laboratories.

Install Larger Booth Equipment

Kraft, Bates & Spencer are having installed at their Boylston street warerooms a series of Unit booths which are being put in by the Unit Construction Co. There are to be six on one side and seven on the other and the general finish is to be old ivory. These booths are to occupy considerable of the floor space of the warerooms. Harry Spencer is giving his personal attention to the work. With the addition of these booths the warerooms will be especially well fitted to demonstrate the Brunswick proposition, with which the company is having marked success.

Developing Outlying Territory

A recent visitor to Boston was J. E. Pollard, manager of the United Talking Machine Co., of Rutland, Vt., which carries a large line of Columbia goods. Mr. Pollard says that he has lately installed a system of motor trucks which promise to perform a valuable service for the outlying territory, and he adds that he already has seen the good effects of this system as the business in the more distant sections has been wonderfully developed in a short time.

Found Business Moving Well

Joseph H. Burke got back toward the end of June from a week's trip among the principal centers of Connecticut, where he found business moving along in tip-top shape. He says that the trade everywhere is feeling in fine shape and they all are booked up with orders far ahead. Mr. Burke is planning to get away some time in July on a vacation with his family, but as yet he is undecided just where to go, although he leans toward a salt water trip. J. C. Morris, president of the Musical Supply & Equipment Co., was in town the middle of the month and expressed himself as well pleased with the way business is forging ahead in this territory.

Model Booth Near Completion

The model booth to be installed by the Unit Construction Co. at the large quarters of the Eastern Talking Machine Co. in Essex street is not reaching the state of completion as quickly as hoped for. The material now is all on hand and work on it will be rushed, so that it will be ready for use early this month.

A Victor Record With a History

In the Boylston street windows of M. Stein-

Steinert Service Serves

M. STEINERT & SONS CO.

35 ARCH ST.



BOSTON

WHOLESALE HEADQUARTERS

DEVELOPMENT

is the keynote of our policy. We aim to give our trade *prompt delivery and courteous and efficient attention.*

ert & Sons there is a Victor record that is attracting much attention. It was found on the German submarine U-11, when she was surrendered to the Allies and made the trip from Plymouth, Eng., to New York City manned by officers and crew of the United States Navy. This record was presented to Robert S. Weeks, who was very prominent in the last Liberty Loan campaign, by the American commander of the U-boat when the boat was on a recent visit to Boston.

Some Brieflets

George Lincoln Parker, the Colonial Building Edison dealer, went down to Providence the latter part of June for his class reunion at Brown University.

Harold Clapp, who has been serving with the Twenty-sixth Division, and is now discharged from service, is again in charge of the talking machine department of Frank Ferdinand's store out in Roxbury.

Joins Forces in Boston

H. M. Blakeborough, who for quite a time

was the New Haven, Conn., manager of the Columbia, has come to Boston, where he is associated with Arthur Erisman in the conduct of the Grafonola Co. of New England. Mr. Blakeborough at the New Haven establishment has been succeeded by H. L. Moorey, who has been one of the assistant auditors. Mr. Blakeborough has been in New Haven more than ten years.

Frank K. Pennington, assistant general sales manager of the Columbia, was a visitor here a short time ago, making his headquarters at Manager Mann's offices.

Vacations Now Under Way

E. J. Silliman, in charge of the record department of the Columbia, is the first of the Columbia forces to go away on his vacation; in fact, he is already home, following a pleasant two weeks in the country.

J. F. Carr, for the Columbia, started on a fortnight's trip toward the latter part of the month and his itinerary included Albany, N. Y., a trip down the Hudson and a several days' visit

— Oldest and Largest
Manufacturers of Talking
Machine Needles in the
World—There are several reasons

W. H. BAGSHAW CO., Lowell, Mass.

do they have the "Blues" in Boston?

Yes indeed, "Blues" one-steps and fox-trots have taken staid, conservative Bostontown by storm. All New England, for that matter!

New England Folks are one-stepping and fox-trotting to the melodious dance records which the famous Louisiana Five is making, these days, for the Emerson Phonograph Company.

Emerson dance and song hits are selling like the proverbial hot-cakes. If you want to handle a line that keeps your cash-register working overtime, ask us to outline our proposition.



Emerson New England INC.

68 Essex Street, Boston, Mass.

Distributors for Emerson Records, Q R S Player Rolls and Brilliantone Steel Needles throughout New England.

THE TRADE IN BOSTON AND NEW ENGLAND—(Continued from page 62)

in New York, where he combined business and pleasure. He was accompanied on the trip by his daughter, who has been attending a private school in Boston.

General Manager Herbert Shoemaker, of the Eastern Talking Machine Co., who is forging ahead most commendably, has been attending the Victor jobbers' convention at Atlantic City, where he met many of his old friends. Charles H. Farnsworth, president of the Eastern Co., was lately over at the Victor factory, remaining there for several days.

On Visit to Chicago

Harry Spencer, of the firm of Kraft, Bates & Spencer, whose house carries the Brunswick, was a Chicago visitor early in the month, having gone there for the convention of the piano men.

Did Surprising Business

Clarence W. Hill, manager of the Music Shop, located in the Meeting House Hill section of Dorchester, and which is an exclusive Columbia shop, did a surprising first day's business when he opened up a few weeks ago.

United Co. Takes on Another Floor

The United Talking Machine Co. of Brockton, Mass., has just added another floor to its talking machine department. The company's business has developed so rapidly of late that this addition was absolutely necessary to meet the demands of its customers. With this additional space there will be better opportunity to display a number of art models for which there was not room before. The company is planning to handle a line of pianos later on at not only its store here, but at its places in Plymouth and Willimantic, Conn.

Attended Edison Convention

Boston was well represented at the Edison convention in New York. Among those attending from this city were Manager Frederick H. Silliman and the four traveling men of the Pardee-Ellenberger Co., L. H. Ripley, F. S. Boyd, Guy R. Coner and E. B. Compton; Will-

iam E. Birdsall, of the F. H. Thomas Co.; Francis White, of the Edison department of the C. C. Harvey Co., and Lawrence Barry, of the same company's Lynn store.

Kenneth Read, traveling man for the Victor department of the Steinert house, was one of those going over for the Victor convention in Atlantic City this week. Mr. Read made the trip by boat from Boston to New York. Prior to starting for the convention he made a tour

of the Steinert houses through New England and was away for a week. Robert A. Steinert, manager of the Victor department, had planned to go to Atlantic City also, but the sudden death of his brother, mentioned elsewhere, caused him to abandon the trip.

The Edison parlors of the M. L. Parker Co., Davenport, Ia., have issued a new booklet for Edison dealers and prospects in that territory.

The Brunswick

ALL PHONOGRAPHS IN ONE

A MUSICAL INSTRUMENT OF CHARACTER FOR THE CRITICAL DEALER

IF LOCATED IN NEW ENGLAND WRITE

KRAFT, BATES & SPENCER, INC.
156 BOYLSTON ST. BOSTON, MASS.

"THE COMPLETE BRUNSWICK DEALER SERVICE STATION"



A Recent Curry Installation

The Curry plant is one of the best equipped wood-working plants in Boston. Over 11,000 sq. ft. devoted to the production of talking machine booths and accessories.

CURRY INSTALLATIONS SHOW INDIVIDUALITY

Each installation is designed to suit the location after inspection by our architect.

The construction of Curry Booths has proven exceptionally satisfactory. There has never been a sign of a crack and no sectional joint openings.

As best proof we submit a partial list of Curry installations of many years' standing.

- A. McArthur Co., 111 Washington Street, Boston.
- Rosen's Talking Machine Co., 11 School Street, Boston.
- Frank Ferdinand, Inc., 2260 Washington Street, Boston.
- Jordan, Marsh Co., 450 Washington Street, Boston.
- Charles S. Norris, 181 Tremont Street, Boston.
- Hallet & Davis Piano Co., 146 Boylston Street, Boston.
- The Grafonola Co. of New England, 174 Tremont Street, Boston.
- C. F. Hovey Co., 33 Summer Street, Boston.
- Royer Talking Machine Co., 1 Kingston Street, Boston.
- Bates & Holdsworth, Framingham, Mass.

Watch out for J. H. Remick's new installation, 168 Tremont St., Boston, Mass.

FRANK B. CURRY

Manufacturer

72-74 E. Dedham St.

Boston, Mass.

ENTER A. DORMAN GEISSLER, JR.

Arthur Dorman Geissler, president of the New York Talking Machine Co., is celebrating the arrival of another prospective power in the talking machine field in the person of Arthur Dorman Geissler, Jr., who made his appearance on June 23. While the youngster has not issued any statement of his future intentions we may easily imagine what his work will be as soon as he is old enough to follow in his father's footsteps.

ENTERPRISING INDIANAPOLIS HOUSE

INDIANAPOLIS, IND., July 1.—The Sonora talking machine department of Charles May & Co. is one of the nicest equipped in the city. Ernest L. Arthur, manager of the exclusive Sonora department, is pleased with the record the department is making in its opening weeks. This is one of the oldest and best-known stores in Indiana and is aggressively pushing the Sonora through large display advertising in the newspapers and through billboard advertising.

WINS REDUCED RATES FOR NEEDLES

Walter S. Gray Wins Fight for Proper Rates From Railroad Authorities—Big Saving

SAN FRANCISCO, CAL., July 3.—Walter S. Gray has won the deepest gratitude of the talking machine dealers, not only of the Pacific Coast, but throughout the entire United States, for his strenuous work with the railroad authorities on the subject of rates on talking machine needles. For years the rate on needles has been double that of talking machines and parts. Many efforts have been made to convince the Western Classification Committee of the railroads that this was an erroneous classification, but without effect, until recently Mr. Gray took the matter in hand, with the result that talking machine needles are now classed as talking machine parts and bear the same freight rate. This is a clear saving of 50 per cent. of the former rate. The saving for the dealers in dollars and cents will be considerable, and many have expressed their appreciation of Mr. Gray's work.

The Culp Phonograph Co., New York City, are taking advantage of the summer months to bring their line forcibly to the attention of the trade. In this way A. Culp, president of the company, is planning to equalize the rush of the latter months of the year.

Lansing Khaki Moving Covers

Despite the obstacles that have arisen during the past year have maintained their high standard of

QUALITY

The Quality of the LANSING cover has given it leadership in the field.



No. 3 Carrying Strap Shown in Cut

These covers are made of Government Khaki, interlined with heavy felt in Grade A, or cotton in Grade B, fleece lined, quilted and properly manufactured under the personal supervision of E. H. Lansing, the originator of the Talking Machine Cover for protection in moving. Made in two grades.

Write for prices and descriptive catalogue

E. H. LANSING
611 Washington St., BOSTON

San Francisco Representative: WALTER S. GRAY
508 Chronicle Building

JAQUITH MACHINERY BUREAU, Inc.

Designers and Builders of
SPECIAL MACHINERY

Mechanical and Electrical Devices
Designed, Developed and Patented
Correspondence with Talking Machine Industry invited
77-79 North Washington St., Boston, Mass.

REPAIRS AND REPAIR PARTS

Low Prices and Efficient Work
Phonograph Supply Co. of New England
28 School Street, Boston

WIDMANN RETURNS FROM SIX WEEKS' EUROPEAN TRIP

President of Pathé Frères Phonograph Co. Confirms Report That His House Will Handle All Pathé Phonograph Products for Entire Western Hemisphere—Schipa to Record for Pathé

E. A. Widmann, president of the Pathé Frères Phonograph Co., arrived in New York Monday, June 30, on the French liner "Lorraine," after a six weeks' absence. Mr. Widmann confirmed the report previously received by cable stating that he had contracted with Pathé Frères in Paris to handle as from July 1 all the Pathé phonograph products for the entire Western Hemisphere, Great Britain, her



E. A. Widmann

colonies and possessions. Mr. Widmann announces that under this arrangement the British company, its stock, plant and policy will hereafter be controlled by his American company. In behalf of the American company Mr. Widmann has arranged with M. Jacques Pathé and M. Emile Pathé to act as managers in London. Since the war started the French

Pathé Company have erected extensive factories in London, but these will be at once greatly enlarged so as to be a duplicate of the Brooklyn plant, which is now being extended to cover the whole block on Grand avenue from Flushing to Park avenue. Mr. Widmann said that records in France are selling at a very much higher price than in America, but that in London, although selling at a very much higher price than before the war, records are selling at about the same price charged in America.

Mr. Widmann also announces that Pathé has made an exclusive contract for the recordings of Tito Schipa, said to be one of the most wonderful tenors in France. Schipa's reception in the Royal Opera House at Madrid was greater than that ever given any other operatic artist. He is now in South America, where he will sing during the season, and later on will go to Chicago as leading Italian tenor with the Chicago Opera Association.

VAN WICKLE CO. REBUILDING

WASHINGTON, D. C., July 2.—Work is rapidly being completed on the new building of the Van Wickle Piano Co., Washington, D. C., and present indications are that the quarters will be ready for occupancy some time before the middle of the present month. Many important changes have been made in the structure at 1217 F street, which was destroyed by fire some months ago, and the new home of the Van Wickle Piano Co. will be able to take care of the increasing business of this concern. A large stock of pianos has been ordered from the manufacturers and in addition to pianos the Victor and Columbia talking machines will be handled.

The Starr phonograph and Gennett records are featured by the advertising of the Music Shop, Pittsburg, Kans.

The "PERFECTION" REPRODUCER

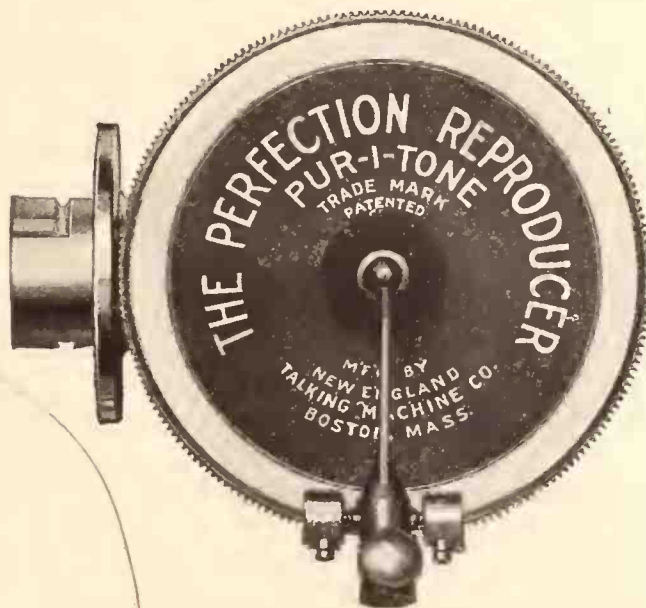

No. 11a
"PUR-I-TONE"
TYPE

reproduces all makes of hill and dale records on Columbia machines, especially Edison Disc records. The reproduction of sound through the medium of this reproducer is the most perfect that may be desired on the part of Columbia owners who wish to play Edison Disc records on their machines.

These reproducers are the very finest made, mechanically—reproducing as the records were recorded in the recording room—Clarity of sound with great volume.

IN STOCK FOR IMMEDIATE SHIPMENT — WRITE FOR QUANTITY PRICES

Manufactured by

New England Talking Machine Co.

The Largest Manufacturers of Phonograph Accessories in the World

16-18 BEACH STREET BOSTON, MASS.

Pacific Coast Distributor: **WALTER S. GRAY**

Chronicle Building, San Francisco, Cal.

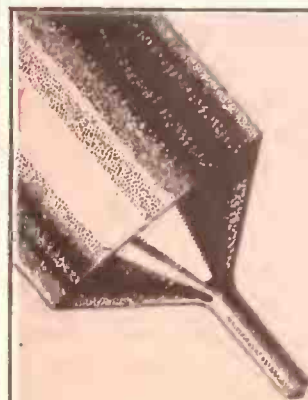

Millions have
already been sold!

Millions of these wonderful needles are now used and they are giving unequalled service and perfect satisfaction. Delighted purchasers are telling their friends and sales are growing very rapidly.



Semi-Permanent
Silvered

NEEDLES

enable you to make excellent profit. No matter what make of phonograph you handle you will find it advisable to have these needles in stock to supply your customers who are asking for them.

Sonora Semi-Permanent Silvered Needles are for use on ALL MAKES of steel needle records, play 50 to 100 times, are more convenient, more economical, and increase the life of the records.

Our production department is constantly increasing its capacity in order to satisfy demand. Send your order at once to get prompt delivery.

3 Degrees—
Loud, Medium, Soft
30c per card of 5
40c in Canada

**Sonora Phonograph
Sales Company, Inc.**

George E. Brightson, President

279 Broadway, Dept. Y, New York

TORONTO: Ryrie Building

Caution! Beware of similarly constructed needles of inferior quality

FOUR-STATE ASSOCIATION PLANNED IN CLEVELAND

Plan to Organize Dealers of Ohio and Neighboring States in One Body to Be Taken Up This Week—Cleveland Trade Happenings

CLEVELAND, O., July 7.—The Talking Machine Dealers' Association of Northern Ohio will hold its monthly meeting July 17, when reports upon efforts to form an organization of dealers in four States—Ohio, Pennsylvania, Indiana and Michigan—may be received. It is proposed, if possible, to make Cleveland the headquarters of the four-State association, because dealers in this section of the Middle West recognize that the organization in Northern Ohio is a model one.

Charles K. Bennett, general manager of the Eclipse Musical Co., distributor and retailer of Victor machines, and former president of the Cleveland association, is looking after the preliminary work of forming the proposed new body in Ohio. Charles Grinnell is doing a similar line of work in Michigan.

Several Cleveland men were among those who attended the conference of Victor jobbers and dealers in Atlantic City, the last week in June. Mr. Bennett headed the Clevelanders. Others included Charles Maresh, of the Maresh Piano Co., and M. O. Matlin, of the Home Piano Co.

The Cleveland Music Trades Association, several of whose members are handling talking machines, will have a picnic and outing at the country home of A. B. Smith, head of the A. B. Smith Piano Co., of Akron, O., and president of the association, July 14.

Talking machine dealers are pleased over the outcome of an effort of piano movers to raise their prices. A strike was threatened several weeks ago by these movers but a compromise was reached by dealers agreeing to pay certain competent men what they wanted and in some instances even more, leaving the incompetent mover without much real backing, so they never struck. The same agreement was reached with the piano tuners who wanted increased pay for their services. The best tuners are well paid.

Talking machine and piano dealers do not like the system some manufacturers have of billing pianos and talking machines and the boxes containing them on one bill.

Frank Jackson, a talking machine salesman, of St. Louis, was among the Cleveland visitors recently.

AUTOMATIC COVER SUPPORT

SIMPLE—SUBSTANTIAL
ECONOMICAL

No. 1287

No Springs to Get Out of
Order

Order Now for Future Delivery

Finished in

- GOLD
- SILVER
- NICKEL
- COPPER
- BRASS

WEBER-KNAPP CO.
JAMESTOWN, N. Y.

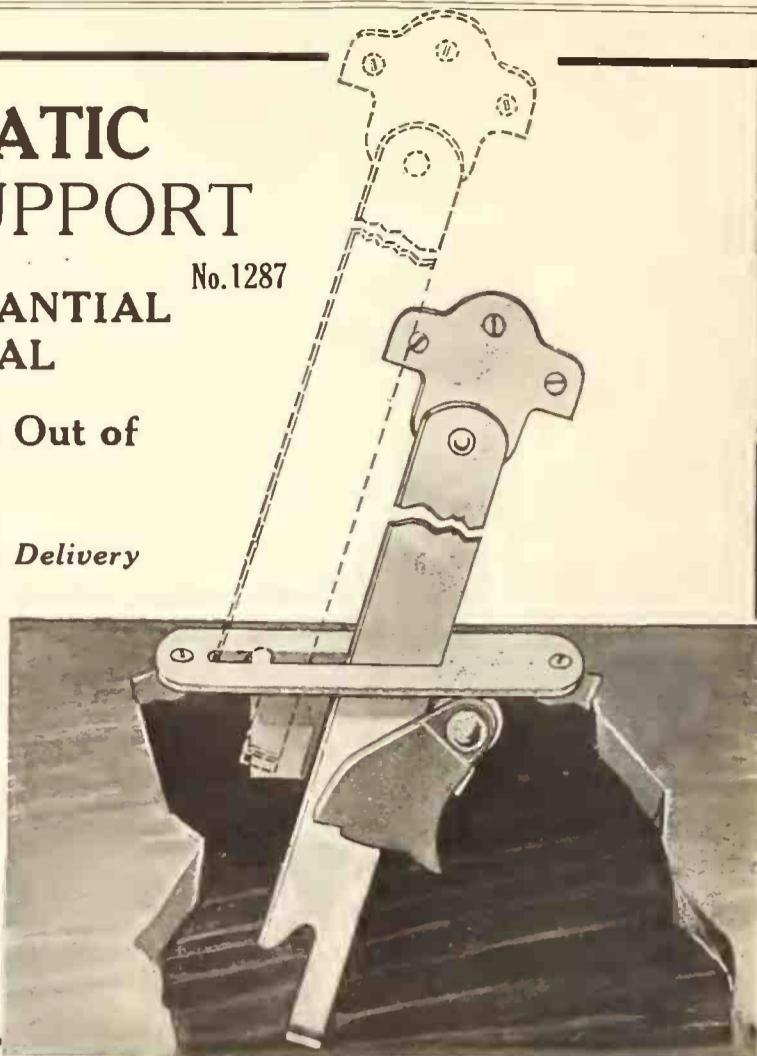

The big July Fourth home-coming celebration in Cleveland in honor of the city's discharged soldiers gave an impetus to music rolls, talking machine records and sheet music of the patriotic type. Cleveland's Director of Parks and Public Property, Floyd E. Waite, backed by the financial resources of the Mayor's advisory war board, staged a \$10,000 pageant, "Democracy in the Making," in one of the parks. This was supplemented by a community chorus of 2,000 voices in the open air. Prof. Haper Garcia Smyth directing the army of singers. About 1,500 persons participated in the pageant. Parades, pyrotechnical displays, street carnivals and concerts by bands added to the day's festivities. The demand for talking machine records reproducing war songs and patriotic music was exceptionally brisk, all dealers said.

The Starr Piano Co. has just added a big line of phonographs to the stock of the firm's four

Cleveland retail stores. Since the war ended the Starr factory, in Richmond, Ind., has been rushing to make up lost time on orders for talking machines.

Even the signing of the peace treaty has not brought out from under the ban talking machine records reproducing German songs. This class of records, when banned several months ago by members of the talking machine dealers' association, included about 1,000 titles. The Muehlhauser Brothers Piano Co. is featuring \$1,000 Corona phonographs in July Fourth window displays. The Cheney Sales Co., 4614 Euclid avenue, distributor for the Cheney phonograph, is making big strides for new avenues of business in Cleveland and throughout northeastern Ohio.

T. H. Towell, president of the Eclipse Musical Co., says that the talking machine business is just getting "its findings" with music lovers. In addition to his talking machine interests he is president of the Cleveland-Cadillac Co., wholesaler and retailer in Cadillac and Dodge automobiles. The distributing department of the Eclipse Musical Co. is located on the second floor of this building, while the company's retail store is located a few blocks down Euclid avenue, in the heart of the city's shopping district.

The Brunswick phonograph machine is not only holding its own among others in Cleveland but is steadily finding a stronger foothold among lovers of high-class phonographs for home amusement. The firm's branch store, in Huron road, is always well stocked with machines.

The Young Furniture Co., which operates two of the largest house furnishing emporiums in Cleveland, is constantly adding to its talking machine line of stock.

TO OPEN NEW STORE

The Glendale Phonograph & Piano Co., of Glendale, Cal., has leased a store in Burbank, and when alterations are completed this new branch will be run by the Salmanica brothers.

ATTENTION DEALERS

We manufacture a beautifully designed and splendidly constructed Talking Machine of the large 50-inch type. Write for illustration and terms.
TYROLIA TALKING MACHINE CO.
WILMETTE, ILLINOIS



TONE ARM AND REPRODUCER

Beware of unscrupulous infringers. We intend to protect our rights and our customers by prosecuting all infringers.

No Springs
Nor Weights
To Adjust



PATENTED
MAY 13, 1919
Plays any Make
Record Perfectly

Made in
Four
Lengths

Its appearance alone, when attached to your phonograph, will greatly enhance the selling value of your machines, both to the trade as well as to the ultimate purchaser, and when it has been demonstrated on all of the different types and brands of records, the tonal quality of its reproduction will appeal to the most critical musician.

"Designed by an artist and manufactured by a master mechanic," is the apt verdict of a veteran in the phonograph industry. We are in position to supply the needs of a few more high-class phonograph manufacturers, and to guarantee prompt shipments.

Write us for prices and descriptive circular

THE EMPIRE PHONO PARTS COMPANY

Sales Office: 425 So. Wabash Ave., CHICAGO, ILL.

Factory: CLEVELAND, OHIO

Address all inquiries to Chicago Office

“Friends” and “Smiles” and “Tears” are all big hits. “Friends” is the latest one. A-2744.

**Columbia Graphophone Co.
NEW YORK**



REMARKABLE DEVELOPMENT OF TRADE IN SAN FRANCISCO

Music Stores Rapidly Being Outnumbered—Heineman Progress—Recording Numbers of Talking Machines—Widdicomb Display at Baldwin’s—Business Brisk, With Satisfactory Outlook

SAN FRANCISCO, CAL., June 28.—Perhaps nowhere else in the country has the talking machine business shown such a remarkable development in proportion to the population as on the Pacific Coast. It seems but a short time since the business was a mere side issue of the music trade, while now the number of stores devoted exclusively to talking machine goods probably outnumber the regular music establishments. In the large cities some of these stores are regal in their equipment and occupy the most prominent locations in the business districts. The music houses, without exception almost, have been compelled to devote their most attractive space to the talking machine departments and judging by the vast amount of alteration work going on the future prospects are very bright. The shortage of standard machines is a great inconvenience to the trade, but there is no lack of new makes. The rapid increase in the number of manufacturers on the Coast is somewhat disconcerting and one wonders how success can be possible with most of them, especially when prices are being maintained on so firm a basis as they are at present. The general report is that the more expensive machines show the strongest demand.

Though only established in San Francisco a few months, the Pacific Coast branch of the Otto Heineman Phonograph Supply Co., Inc., has already had to increase both its office force and storeroom space. L. Gruen, the manager, is gratified that his company has been so liberal in supplying him with stock notwithstanding

ing the heavy Eastern demands upon the factories and he says this fact has done much to gain him the goodwill of the Coast trade. By making prompt deliveries he has won the confidence of his new customers and has established a reputation for excellent service. Jobbers in all the principal cities of the Pacific Coast region now handle Heineman goods and show a disposition to co-operate with Mr. Gruen in developing the market, both for the popular OkeH records and the various specialties. The repair department in San Francisco fills an urgent need and is kept busy all the time. Most of the Heineman and Meisselbach products can be repaired here without sending East. The 6C soundbox, the new product recently introduced to the trade, is considered a wonder for tone quality and volume. Some of the largest manufacturers of talking machines on the Coast are using it exclusively in their machines.

The Talking Machine Dealers' Association of the San Francisco Bay District, at their last business meeting, adopted a policy of recording the number of each machine which is brought in for repairs at the various repair shops, with the idea of keeping track of all machines. Thus stolen machines may be traced more easily and the dealers given greater protection against irresponsible buyers. A special list of missing machines will be placed with all the dealers so that they can be on the lookout for them. This co-operative measure helps to solve one of the most puzzling problems in the business. Other progressive plans will be discussed at the next business meeting.

F. A. Levy, president of the Talking Machine Dealers' Association and president of the California Phonograph Co., has planned to leave this week for an extended Eastern trip, combining business and pleasure. He will study conditions in the Eastern trade with the idea of discovering new wrinkles for the Coast business.

The latest arrival at the Sonora Shop on Stockton street is the beautiful \$140 model called the “Nocturne.” This machine will prove a winner, thinks E. C. Johnstone, the store manager, as it combines the best features of the Sonora machines with a popular price. Business on high-priced machines is encouraging. The special featuring of the Sonora Invincible has already borne good results. The demand for machines for country homes has increased this year, as the exodus to the country this summer is unusually heavy.

Andrew McCarthy, of Sherman, Clay & Co., is attending the annual jinks of the Bohemian Club at Bohemian Grove on the Russian River, an event which he never misses. Four members of the company are at the grove this year. Sherman, Clay & Co. are making extensive alterations in both their Tacoma and Spokane stores.

The talking machine departments will be greatly enlarged and improved by the addition of some of the newest equipment features.

R. E. Wolfinger, of the Wiley B. Allen Co., is about to leave for his annual vacation. This year he will visit the Yosemite and also southern California as far as San Diego. The chances are he will cross the Mexican border. Tijuana promises to be a popular resort for Americans in the very near future.

The Baldwin Piano Co., of San Francisco, has been displaying on the main floor for the last few weeks the line of Widdicomb phonographs manufactured in Grand Rapids. Mr. Thompson says he is trying out the idea of selling talking machines on the piano floor and if the scheme proves sufficiently attractive he will make it a permanent feature of the business. Some of the piano salesmen are former talking machine specialists. No records are carried.

New Pathé agencies recently established by Omer Kruschke, the Pacific Coast Pathé jobber, are: The Morgan Furniture Co., Livermore; J. R. Ricks, Dinuba, and Miller & Pinell, of Porterville.

Columbia business is heavy all along the line. Mr. Milnor, manager of the San Francisco office, has been calling on the Columbia agencies in the San Joaquin, and says the prosperous condition of the interior means a continuance of good talking machine and record business. The traveling force of the company has not yet been able to let up on activity despite the summer vacation season. Mr. Milnor attended the national convention of the Rotary Clubs at Salt Lake City June 16 to 21. Byron Mauzy, of San Francisco, also attended it on his way to the Piano Merchants' convention in Chicago.

INCORPORATED

The Repeatograph Co., Dover, Del., has been incorporated to manufacture talking machine repeating devices and attachments. The capital stock is \$100,000.

The Mutual
TONE ARMS & SOUND BOXES

**Speak
for
Themselves**

Mutual Talking Machine Co., Inc.
145 West 45th Street, New York

LANGUAGE RECORDS



Progressive Dealers sell
**LANGUAGE
Phone Method**
and ROSENTHAL'S
Practical Linguistry

The courses are so simply arranged that the demonstration satisfies the prospect. An excellent line for high-class dealers. We especially want to hear from dealers with good store locations.

Write for dealers proposition, booklet and advertising matter.
THE LANGUAGE PHONE METHOD
992 Putnam - 2 West 45th Street, - New York

BUFFALO CONTINUES TO BE A LIVELY TRADE CENTER

Fire Visits Neal, Clark & Neal Store—Confined to Basement and Rear—Andrews in New Wholesale Headquarters—Hoffman Expansion—Placing Orders Now for Holiday Stock—New Brunswick Agents—News of Month

BUFFALO, N. Y., July 2.—Fire visited the retail store of Neal, Clark & Neal, Victrola agents, on the evening of July 1. The loss was caused by fire, water and smoke and is estimated at \$10,000. The fire was confined to the basement and rear and was held in check on account of the excellent judgment of the firemen. Several of them, who wore gas masks, were overcome by the smoke. The blaze broke out in the evening and after working about two hours the firemen had it under control. The place was kept open all night and the fans in the booths and the overhead suction fans were in operation until morning in driving out the smoke. Very few machines were damaged and the store was open for business as usual next day. B. E. Neal and O. L. Neal were absent at the time. They were attending the Victor Jobbers' convention at Atlantic City. They were reached by long-distance telephone by W. J. Bruehl, sales manager of the store, who apprised them of the fire. Mr. Bruehl sent a letter to all the Buffalo newspapers, in which he praised the good work of the firemen, who in extinguishing the blaze worked carefully and minimized the damage to the elaborate store.

W. H. Reilly recently arranged a beautiful New Edison window for the Utley Piano Co.'s store. There was a background of green lattice work in an arch effect and across the top were the words, "New Edison." The central feature of the display was an official laboratory model.

W. D. and C. N. Andrews have moved into their beautiful new wholesale headquarters in the Builders' Exchange at Pearl and Court streets. Complete details of the improvements

"A Million A Year"

WHAT'S YOUR SHARE OF

MICA DIAPHRAGMS OF BEAUTY

—Phonographically Speaking—They Talk for Themselves—
Manufactured for over ten years for the larger consumers by the

INTERNATIONAL MICA COMPANY

Factory and Sales Dept. {	37th & Brandywine Sts. W. Philadelphia, Pa.	Mines, Amelia Co., Va.	Executive { Dept. {	1228 Filbert St., Philadelphia, Pa.
------------------------------	--	---------------------------	------------------------	--

Send for samples and quotations now and eliminate your diaphragm difficulties

in the building, of which they are owners, will be given later. C. N. Andrews and Mrs. Andrews attended the convention of Victor jobbers at Atlantic City. He and a member of his staff went on the trade-boosting excursion of the Buffalo wholesale merchants and manufacturers and furnished a Victrola for the trip. F. P. Besser recently returned to his former position with the firm. He served with the 106th Field Artillery in France. For a time he attended the American artillery school at Samur, France.

The Hoffman Piano Co., distributor of the Okeh records in this territory, is daily adding to its list of dealers. The Hoffman Co. has received a new shipment of these records and an abundance of high-class literature pertaining to them. "These new records are remarkably clear, distinct and full-toned," said L. M. Cole, manager of the Hoffman talking machine department. "We are planning for a great fall campaign on this merchandise."

With the temperature reaching the hundred mark, Buffalo's talking machine dealers are fixing their minds on Christmas. The reason is that on account of the shortage of goods many of them are wisely placing their holiday orders now. This they are doing for their own protection. So far as summer trade is concerned there is an extra heavy demand for summer portables, which fill the bill most satisfactorily. There is

also a lively call for expensive models. Working people are demanding the best in talking machines and have plenty of money to buy high quality goods.

W. H. Tyler has been appointed a salesman for the William Hengerer Co.'s Victrola department. H. J. Childs, assistant manager, has a large acquaintanceship among Buffalo's downtown business men and this connection has helped him in making many sales.

"Please send in my subscription to The Talking Machine World," he said. "I want to be fully informed all the time and The World is by far the best medium."

L. H. Scott, manager of the Hengerer Victrola department, says that despite the hot weather business is better than last year.

Among the firms which have lately been appointed Brunswick agents are the Koskie Music Co., Hornell; the Andrews Piano Co., Jamestown, N. Y., and Arthur M. Ferris, Utica. Speaking of the foregoing concerns, J. R. Flynn, manager of the Brunswick branch in Buffalo, said: "On account of the high standing of these firms our head office decided to add them to the Brunswick family. The dealers of this section of the country are keeping the Buffalo branch busy explaining that it is impossible to take on any more dealers. Many of our best dealers are placing their Christmas orders in self-defense as they are seeing the light."

The young ladies employed by Denton, Cottier & Daniels recently held an enjoyable picnic at Delaware Park. Among the features was a ball game, which ended in a tie score. In the evening Mr. and Mrs. Daniels treated the picnickers to a motor trip through Buffalo's parks and other delightful points about the city.

E. O. Hock, formerly connected with the Victrola department of the Robert L. Loud Music Co., has returned to the employ of that concern. For several months he was connected with the adjutant's department at Camp Upton.

A. F. Koenig, of the Koenig Piano Co., has bought a beautiful home at 611 Linwood avenue. Other residents of this thoroughfare include William H. Daniels, of Denton, Cottier & Daniels; George Goold, of Goold Bros., and Walter Erion, of the Erion Piano Co. Mr. Koenig and O. L. Neal, of Neal, Clark & Neal, were among those who recently attended the annual picnic of the Buffalo Optimists' Club.

A. H. Trotter, traveling representative of the Gibson, Snow Co., New York State distributors of the Sonora, was a recent caller.

The Hoffman Piano Co. is making a feature of models of the Sonora portables which were recently displayed in an effective manner in the Hoffman show window. L. M. Cole is manager of this department.

Joseph De Pasquale, who was the "brains" of the gang that robbed George Mossinger, treasurer of C. Kurtzmann & Co., was recently sentenced by Justice Brown to thirty-eight years in Auburn prison.

A cargo of fresh opinions on business was brought home by 500 Buffalo boosters, who recently went on the Chamber of Commerce cruise to Cleveland. The talking machine trade was represented on the trip.

Edward H. Droop, of E. F. Droop & Sons Co., Washington, D. C., will occupy his lodge in the Blude Ridge Mountains this summer and will be able to keep in touch with his business in the capital.

PHONOGRAPH CASES

Reinforced 3 ply veneer
THE STANDARD CASE
for Talking Machine and Records



Made by

PLYWOOD CORPORATION

GOLDSBORO, N. C.

8 Mills in Va., N. C., and S. C.

New York Office, 103 Park Ave.

Chicago Office, 111 Monroe St.

and
**Plywood
Cases**

ARE SYNONYMOUS

For 10 years phonographs have travelled in plywood cases and have reached destination in perfect condition.

Our capacity and experience in manufacturing insure you getting good service and well made cases.

We make record cases too.

Let us figure on your requirements.

The Modernola

*A Home Delight
to Ear and Eye*

*If You Are
To Sell Them—*

It's important that you make territory reservation and place your initial order—at once.

For while we are now in our large new factory, and production has been largely increased, we are finding it impossible to keep up with the demand for this different, distinctive member of the phonograph family.

The Modernola is a circular instrument, its graceful rounded effect and artistic finish adding wonderfully to any setting.

And then the Lamp feature. What life and color it gives to the dealer's window and floor displays. How much easier it makes selling.

And in the home—how a Modernola brightens and cheers—when silent as well as when entertaining.

Here's an instrument of 100 per cent. satisfaction for everybody. All equipment is of high quality and proven merit. The Saxophone Horn Chamber is original with The Modernola. Its tone richness and evenness is unsurpassed.

United States Government Patents cover designing and the exclusive Lamp Shade feature. Modernola sales rights will prove of more and more value.



The Modernola is round. The Lamp is detachable.

**WRITE—
DO IT NOW**

Territory is being allotted. Your request will bring desired information. Write at once and be prepared to sell Modernolas in your city, town or territory.



**THE MODERNOLA CO.
JOHNSTOWN, PA.**

“Mickels”—Really “Live!”

With Two (2) Aggressive, Thoroughly Capable Victor Distributing Points—Omaha and Des Moines



And, if you were to ask: “Which is the bigger and busier, the Mickel ‘Omaha’, or Mickel ‘Des Moines’ establishment?” the answer would be: “They’re BOTH LIVE WIRES.”

Seldom, indeed, has any American concern succeeded in keeping TWO establishments so nearly alike in the matter of the business done, stocks carried and services rendered.

It’s merely a matter of geography—if the Mickel Omaha establishment looks a little nearer to you on the map or from there—if Des Moines will serve you quicker because of its closer situation to your town, well, then, make it Mickels at Des Moines.

Either way you are going to experience an immense amount of satisfaction. And, by the way, we are going to witness the BIGGEST Victor business in history this Fall. Are you measuring your wits against it? Better get the spirit and start the connection NOW, with

Mickel Bros. Co.

OMAHA, NEBRASKA
DES MOINES, IOWA

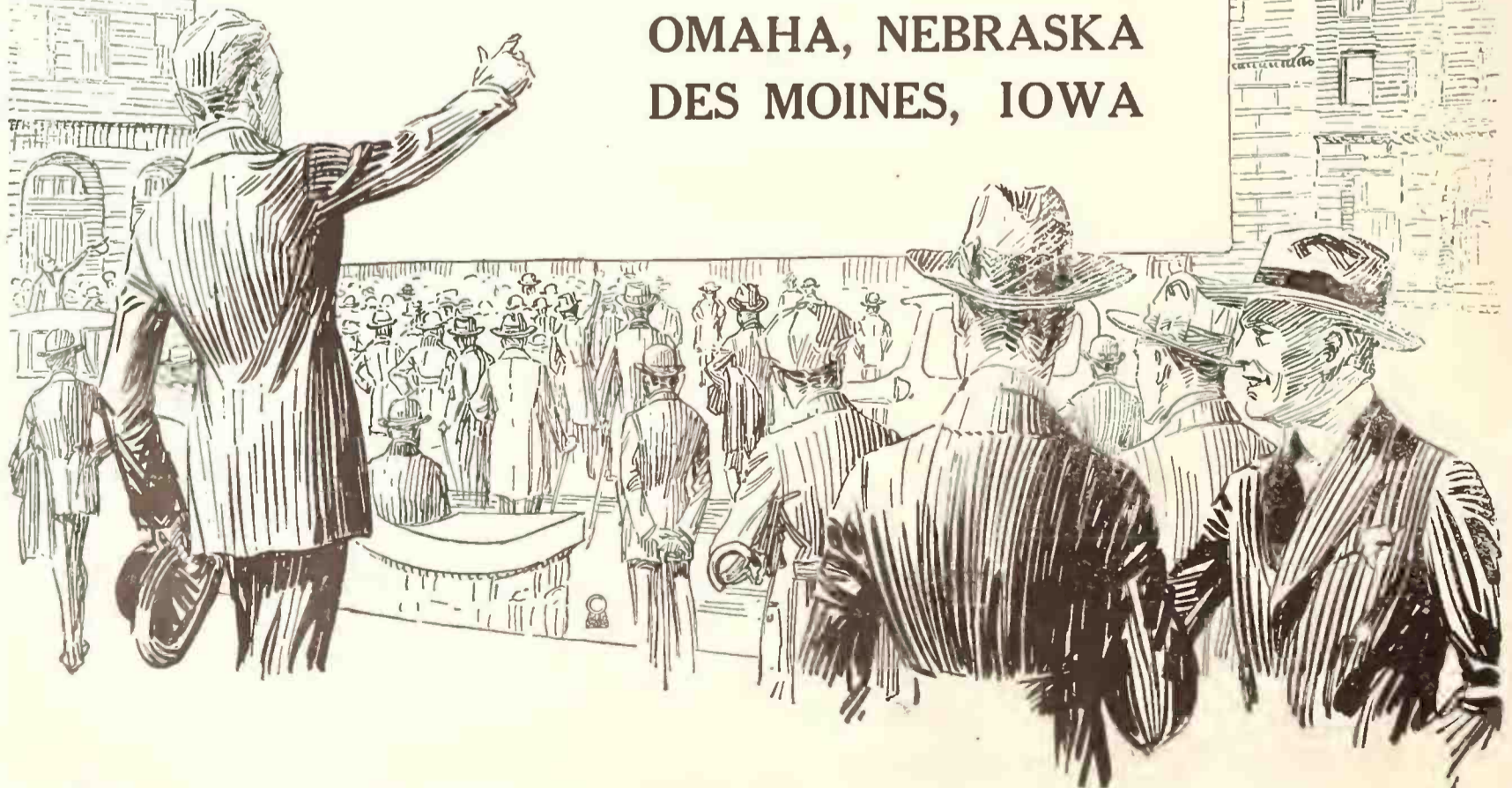

LIVELY GENERAL CONVENTION OF VICTOR JOBBERS AT ATLANTIC CITY

Great Gathering of the National Association of Talking Machine Jobbers, the First Held Since the War, Took Place Last Week at Atlantic City

ATLANTIC CITY, July 2.—The general convention of the National Association of Talking Machine Jobbers, the first meeting of the complete membership of that organization since 1917, was held at the Hotel Traymore here on Monday and Tuesday of this week, with the business sessions proving full of consequence and accomplishment.

Although no general meeting has been held for two years there have been held a number of executive committee meetings to consider the many problems growing out of the war and to the majority of these sessions the membership at large was invited, and, in fact, urged to attend. The association work has not lagged an instant. The official body of the organization had both initiative and the willingness to work and the result was that several serious situations were met and handled in a manner that has proven most gratifying to the members of the body. Then, too, as the conditions warranted, recommendations were made to the Victor factory officials and to the jobbers themselves regarding various phases of the production and marketing of Victrolas and records.

For the most part the general convention this week was given over to a review of what had been accomplished by the association during the past two years and the endorsement of the various recommendations to the factory and the membership at large as embodied in the reports of the president and secretary and presented before the meetings themselves. The confidence of the jobbers, as a whole, in the Victor Co. and its policies and satisfaction in the progress made by that company since the first of the year in getting back to a pre-war producing basis, or better, was plainly in evidence, particularly after a number of the Victor Co. officials, including R. L. Freeman, secretary of the company, had addressed the jobbers and set forth some facts regarding what the company had accomplished and planned to accomplish. At this meeting the jobbers themselves had some matters to discuss with and recommendations to make to the factory officials regarding future activities.

The attendance at the convention was excellent, practically 90 per cent. of the total association membership being represented. Although the arrangements committee had been busy in planning for entertainment, the fact that the majority of the jobbers came to Atlantic City primarily for serious business was evidenced by the fact that the two business sessions scheduled for Monday and Tuesday afternoon were supplemented by a third session on Tuesday morning in order that there might remain nothing undone.

After several executive and general committee meetings held on Sunday and Monday morning the first regular business session of the association was called to order on Monday afternoon and was devoted almost entirely to the reports of the officers and various committee chairmen.

President J. N. Blackman Reviews Conditions in Report

The first report presented was that of the president, J. Newcomb Blackman, which covered the period since the 1917 convention, reviewed present conditions in the trade and was most comprehensive generally. In his report President Blackman said, in part:

When you called me back to the presidency two years ago I not only appreciated the great honor, but accepted the office with a full realization of the responsibility involved.

War Service

We had been in the World War but a few months and with no precedent as a guide no one could forecast the events which have since made unparalleled history. Every true American must feel it a great privilege to live in this generation and to have taken part in the world struggle for the preservation of liberty, finally terminating with victory.

It was inevitable that true service meant sacri-



J. Newcomb Blackman, Retiring President

...ce, and among the many rewards of victory will be a better realization of the fact that most things worth while are accomplished by unselfish sacrifice.

The World Struggle and Business

Germany attempted to force autocracy on the world and prove that "might made right." In this attempt she undertook to tear down a foundation on which this country was built and under which it has prospered. The cost of defense has been great, but the victory is worth while, and, we hope, permanent. Likewise the talking machine business was established on a

attacks on our industry and in like manner there were times when unfavorable Governmental and court action seemed to forecast defeat.

The Recent Colgate Decision

It is my judgment that the recent Supreme Court decision in the Colgate case has correspondingly turned the tide and the principles of honest merchandising will soon be acknowledged and protected again.

We therefore meet in convention again with a feeling that the sacrifices we have made are worthy contributions to the cause of our country and our industry. Let us face the future prepared to meet, and solve as well, the many problems of the transition period.

1918 Convention Omitted

Your executive committee were sustained in their judgment that last year's convention should be omitted in keeping with the need for war economy and to avoid unnecessary travel.

Support Heartily Appreciated

Your officers, national councilor, executive and special committees have endeavored to faithfully perform their duties, which have been many and arduous. The support of these associates and the entire membership has encouraged and stimulated my efforts in serving as your president. It is, therefore, my privilege and pleasure to record here my grateful appreciation.

Communications through the mail and the trade papers have enabled your membership to keep posted on the association's activities. But to resume and refresh memories I want to review some of the most important.

Victor War Service

The patriotic action of the Victor Co. in immediately placing at the disposal of the War Department their entire organization and manufacturing facilities was in keeping with their reputation for leadership and service. The company's manufacture of war material necessitated extreme curtailment of their regular production and the entire trade patriotically and willingly shared in the sacrifice of business.

Industry's War Participations

With the general curtailment of business owing to the war the non-essential character of certain industries became a subject for interpretation. By personal and written argument the talking machine business successfully maintained its claim that it was essential during the war and that "music maintains morale." Its service and contribution were further demonstrated in the many Liberty Loan drives, the various camps, hospitals, on board transports and even in the trenches.

Executive Meetings

Our executive committee met four times since our last convention. Owing to the omission of our last year's convention and the importance of many changes and war restrictions we considered it advisable to hold open as well as executive sessions. All meetings were well attended.

Association Counsel

Owing to the complicated legal situation surrounding the conduct of our business the employment of expert legal counsel, at an annual retainer, was decided upon. Gilbert H. Montague, of New York, who has been closely identified with many test cases affecting sales policies, was retained as our general counsel. He is also one of the counsel for the defendants in the Victor-Macy case, where a

(Continued on page 72)

Officers of the National Association of Talking Machine Jobbers for 1919-1920

President, George L. Mickel
Vice-president, Thomas H. Green
Secretary, A. A. Trostler
Treasurer, W. H. Reynalds

foundation of liberty in the manufacture and sale of honest merchandise. For years our industry was protected by legislation and in the courts. Then the price-cutter, like Germany, with ulterior motives and dishonest propaganda, attempted to force recognition of the false principle that "Opportunity Is Privilege."

In the World War we fought with every resource, staking our lives on principles, which, if deserted, would be renounced. A year ago the enemy seemed to have victory in sight and then the tide turned and success crowned our efforts. During the same period and with the same confidence we have been defending the

**Next Convention
Atlantic City, 1920**

LIVELY GENERAL CONVENTION OF VICTOR JOBBERS AT ATLANTIC CITY—(Continued from page 71)



Attendants at the General Convention of the National Association of Talking

number of our New York members are co-defendants. The clear and concise explanation and advice given by him in our two last general meetings, as well as his guidance in association procedure, have been extremely valuable.

Revenue Bill Work

Our efforts to avoid unreasonable and discriminating taxation have been very successful. The final tax in the 1917 Revenue bill of 3 per cent. on the manufacturers' sale price and a 1½ per cent. floor tax was really a compromise after many hearings and conferences in Washington, in which the Victor Co. and our association took a prominent part. The United States Chamber of Commerce, evidently through ignorance of the facts, presented our industry in a most unfavorable light in its referendum number 25—recommending drastic tax measures. Victrolas were all classed as luxuries, and a 20 per cent. tax on the retail price

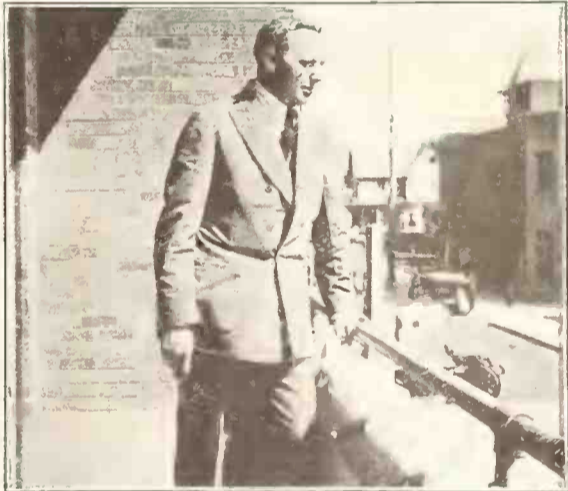

L. C. Wiswell, Free of Convention Worries

recommended. Discrimination was apparent, although no doubt unintended, for other musical instruments were classed more favorably and some exempted.

Protest on Referendum No. 25

Owing to the influence of this national body and its referendum I filed a strong protest with Mr. Goodwin, the secretary, which was published in the trade papers, and used by our secretary as a brief for the same purpose when our executive committee voted on the referendum in question. Later developments indicated that our efforts were successful.

1918 Revenue Bill

The 1918 Revenue bill necessarily taxed heavily almost everything except war merchandise. The original House bill imposed a tax of 10 per cent. on the manufacturer's sale price, as well as a floor tax. The need for revenue was so urgent that the representatives of our trade hesitated to protest too strongly. Convincing arguments finally resulted in the entire elimination of the proposed floor tax and the reduction to 5 per cent. on the manufacturers' sales. The net result was a 2 per cent. increase over the existing 3 per cent. tax in the 1917 bill. The Victor Co. met the situation in the manner now so well known and appreciated by absorbing and paying this increase.

Federal Trade Commission's Hearings

For the purpose of determining the merits

of contending claims on the uniform price question the Federal Trade Commission conducted hearings in Washington on October 3, 4 and 5, 1917. A large attendance and free discussion resulted. Henry C. Brown and members of our association took a prominent part in the debate. The outcome may be best judged by the



Roy J. Keith and Parham Werlein

commission's recommendations to Congress in December of last year, that suitable legislation be enacted to protect reputable manufacturers against unscrupulous price cutters. The Stevens bill was referred to specifically as meeting the situation if amended to provide supervision by the commission. This amendment has since been made.

Action by the Department of Justice

The action of the Department of Justice investigating and declaring unlawful the continuance of certain sales policies affected the Victor Co. and many other manufacturers. In

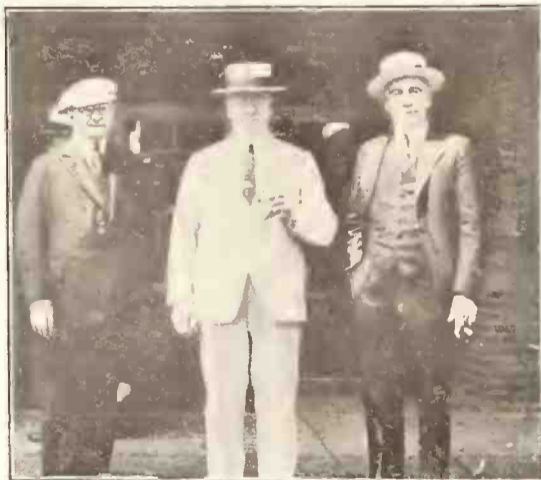

Chas. K. Bennett, P. J. and T. H. Towell the spring of 1918 new Victor prices were announced and the trade were advised that they must exercise their own judgment as to sales and resale prices.

Fair Trade League

Our executive committee and members in open session unanimously agreed that we should join the American Fair Trade League and become permanent contributors. Your president was elected to the board of directors of the league to fill the vacancy caused by the resignation of Louis F. Geissler. At the re-

cent annual meeting of the league the reports of Secretary Whittier and the league counsel, Joseph C. Davies, former chairman of the Federal Trade Commission, were extremely encouraging. The general impression is that with continued efforts the Stevens bill or other suitable legislation will be passed by Congress this session.

The Executive Meeting in January

Our executive committee meeting January 27 and 28, 1919, included two open sessions and was probably the most important and successful ever held. My report and recommendations contained so many subjects of permanent importance that I would like to present part of them at this time for further consideration. A special committee was appointed to prepare a report from the executive committee to the Victor Co. containing also certain suggestions and recommendations. The spirit in



Wm. Nolan, Who Took Care of the Ladies which they were received by the Victor officials showed an unmistakable desire to cooperate to the fullest extent. The response was almost immediate and perhaps the most important action taken was to equalize distributors' costs by a freight allowance announced in the company's letter, to take effect March 1, 1919.

Increased and Concentrated Production

The factory has promised to use every possible resource to greatly increase production. Our suggestion to concentrate manufacture on machines and records in immediate demand has been carried out very largely. The result has been that goods received have been at once sold and waste of labor and material in manufacture has been reduced to a minimum.

Record Supplement and Cut-out List

Monthly supplement issues have been kept down and the August list omitted for a purpose, I believe, generally approved. The large cut-out list announced will be a valuable guide and eventually afford much relief in record stocks.

Summarizing and without regard to preference I recommend that:

First—We continue our activities in the interests of legislation, such as the Stevens bill, and endeavor to accomplish the elimination of the present 5 per cent. manufacturers' tax.

Second—We continue our affiliation with, and support of, the American Fair Trade League.

LIVELY GENERAL CONVENTION OF VICTOR JOBBERS AT ATLANTIC CITY—(Continued from page 72)



Machine Jobbers, Held at the Hotel Traymore, Atlantic City, N. J., June 30 to July 2

Third—The incoming president be authorized to continue employment of legal counsel according to his judgment, subject to the approval of the executive committee.

Fourth—That the executive committee's reports and recommendations to the board of directors of the Victor Co., dated January 28, 1919, be reviewed and supplemented according to the judgment of this convention or the executive committee.

Interesting and Constructive Report by Secretary Roush

The next report presented, which was likewise comprehensive and interesting, was that of the secretary, Joseph C. Roush, and was, complete, as follows:

The more important phases of the secretary's work since our last convention in July, 1917, have been covered from time to time by written reports direct to the membership.

In addition to the usual routine duties of the secretary's office during the past two years

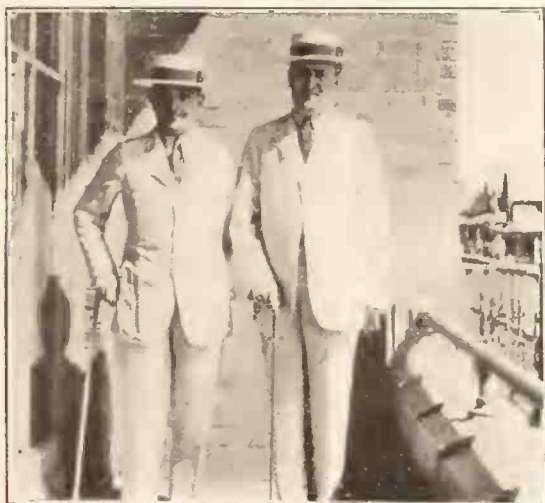

The Palm Beach Twins, E. P. Hamilton and Thos. H. Green

there has been considerable special work, occasioning a number of trips to Philadelphia, to Washington and to the factory for conferences with President Blackman and other members of the executive board, attendance at hearings before the Federal Trade Commission, conferences with factory officials, etc. The secretary also sent many letters and telegrams to Congressmen and Senators on behalf of the association during our fight on the luxury tax proposition and the other discriminatory features of proposed tax legislation.

Since the last convention there have been four meetings of the executive committee as follows: November, 1917; April, 1918; September, 1918, and January, 1919. The necessity for these meetings, the action taken and the results achieved are, I believe, sufficiently well known to the membership without requiring a detailed review.

There has been added to the membership roll since July, 1917, the George D. Ornstein Co., of Philadelphia, Pa. Upon the admission of this company to membership it was consid-

ered that the important part which Mr. Ornstein had played in establishing and perpetuating the system of distribution which has made this association possible entitled him to a special note of welcome to our ranks. Accordingly, the executive board adopted a special resolution and caused it to be spread upon the minutes of the association and directed that a copy be suitably inscribed and delivered to Mr. Ornstein.

Upon receipt of the secretary's letter enclosing the resolution Mr. Ornstein replied: "Please accept and express to the members of the asso-



J. C. Roush, Retiring Secretary

ciation my very sincere thanks for the very beautiful and highly flattering testimonial. It is most gratifying to have the little service which I rendered to the distributors acknowledged in this manner.

"Your very truly, Geo. D. Ornstein."

The association has lost the following members; C. Becker, Guatemala, C. A.; S. B. Davaga, New York, N. Y.; Consolidated Talking Machine Co., Salt Lake City, Utah; Greenhut Co., New York, N. Y.; O. K. Houck Piano Co., Nashville, Tenn.; O. K. Houck Piano Co., Little Rock, Ark.; Orton Bros., Butte, Mont., and John Wanamaker, New York, N. Y.

These changes leave us a total membership at this time as follows: Full, 79; branch, 8; total membership, 87.

The secretary has collected and turned over to the treasurer since July, 1917, the sum of \$16,600. He is very pleased to be able to report that all members of the association now on the roster have paid their dues in full to date and that all expense and other bills incurred by the association under its present administration have been paid. There are now no outstanding debts. The affairs of the association will be turned over to the new officers with a clean slate.

Members have been advised of the association's reasons for not holding the annual convention for 1918. The sentiment was strongly opposed to a convention upon patriotic grounds, the result of a mail vote on the subject being five for holding and sixty-one against holding a convention.

It has been the grievous duty of your secre-

tary to chronicle since our last general meeting the deaths of Henry Horton, Elton F. Taft, Mrs. Leslie Wiswell, Robert B. Gregory, C. H. Eisenbrandt, and Russell B. Steinert.

Upon receipt of news of the death of each your secretary immediately sent on behalf of the association floral tributes and suitable expressions of regret.

The membership has been supplied with copy of the written report and recommendations of the association addressed to the Board of Directors of the Victor Talking Machine Co. at the close of the series of meetings held at Philadelphia last January. These recommendations to the factory were summarized under the following heads:

1. Equalization of distributors' costs f. o. b. distributors' city.
2. Greatly increased machine production especially on elevens and fourteens.
3. Immediate and adequate supply of popular selections while "hits."
4. Monthly supplement issues not to exceed twenty-five domestic selections.
5. Immediate record cut-out list of not less than 750 domestic selections.
6. Monthly supplements to be printed and distributed from a central Western point.

It should be most gratifying and encouraging to our members to observe the sincere and determined manner in which the Victor factory has undertaken to comply with our recommendations, and to note that in every essential respect they have actually complied. While it was not found feasible to print and distribute supplements from a central Western point as recom-



Fred H. Putnam, Charles Bruno and Fred P. Oliver

mended, the problem of supplement distribution has nevertheless received earnest consideration, and I am authorized to say the factory will speedily announce a system which promises to give entire satisfaction to all concerned.

Measured from the standpoint of results actually achieved, these January meetings were perhaps the most important and productive sessions in the history of the association. I consider these results especially significant because they indicate a readiness upon the part of the Victor Co.'s Directing Board to carefully weigh

(Continued on page 74)

LIVELY GENERAL CONVENTION OF VICTOR JOBBERS AT ATLANTIC CITY—(Continued from page 73)

the demonstrated needs of the trade when those needs are properly and concisely presented, and to co-operate sincerely with distributors and dealers in broadening and bettering the conditions under which we carry on the business of marketing Victor products—wherever and whenever such co-operation is possible and consistent.

In view, therefore, of the splendid prospects of early relief from the shortage of Victor products which has prevented the full exercise of our sales effort, and of the development of the legal situation as reflected in the Colgate case, with which you are now familiar, the present stability



Louis Buehn, Who Looked After the Arrangements

and the future prosperity of this industry seem doubly secure.

By way of recommendations for the consideration and action of the association at this time I beg to submit the following:

First. That the annual membership dues be reduced to \$50 for full members and \$25 for branch members, and that no membership dues for the year 1919-20 be charged or collected by the Association. When the annual dues were raised in 1917 to \$100 the raise was consented to by the membership because it was considered there existed an emergency wherein the safety and success of the Association demanded a larger outlay of funds than the lower rate of dues would provide. That emergency is passed. In fact, the dues should have been reduced last year, and no doubt would have been reduced had there been a general meeting at which such action could properly be taken.

Second. That members of the Association take advantage of every opportunity to convey to the directors and department heads of the Victor Talking Machine Co. the fullest and clearest possible information as to general trade and competitive conditions existing in their respective territories, and that the urgent need of greatly increased production on both machines and records be constantly emphasized to the factory by citing specific cases, etc.

Third. That members who have up to this time conducted both wholesale and retail operations now carefully consider the rapidly changing trade situation and the future bearing which those changes may have upon the interests of a house conducting both wholesale and retail operations in the same territory.

Fourth. That members carefully consider the new status of competition and representation in our industry as compared with the old status of three to five years ago, and that a most thorough and thoughtful study be made of the subject of readjusting retail representation in such a manner as best to meet the needs of the line in each locality.

Fifth. That those members who believe the present level of list prices on machines and records is low enough, and in the interests of the line should not be reduced, express their belief to the directors and department heads of the Victor Co. at every opportunity. It has been said there is sentiment at the factory favoring return to pre-war price levels as soon as quantity production is again achieved. I submit that it would be more in the interest of the entire trade and would help to maintain better service to the public if the economies accomplished through increased production were expressed by an increased discount to the dis-

tributor, which would enable him in turn to quote a correspondingly increased discount to the dealer, leaving list prices approximately at the present level.

Treasurer's Report

A. A. Trostler, the treasurer, in his report, also covered the two-year period in a most efficient manner. The report covered the financial affairs of the Association for each of the two years and there was also provided a recapitulation, which might be accepted as a complete financial statement of the Association in detail. Incidentally the report indicated that the Association was in a most healthy financial condition.

Mr. Trostler was tendered a vote of thanks for the manner in which he had handled the duties of his office, a mark of appreciation that was also tendered the president and secretary at the conclusion of their reports.

Legislative Committee Reports

The legislative committee, of which George E. Mickel is chairman, presented a short report, much of the matter being already covered in the report of the president.

By-Laws Changed

In order to simplify matters a resolution was adopted changing the by-laws to provide for the holding of general conventions of the Association during the month of June or July instead of confining the convention period to the month of June as was formerly stipulated.

Annual Dues Reduced

Another resolution, likewise adopted promptly, provided for the reduction of the annual dues of association members from \$100 to \$50. The dues, originally fixed at \$25, were increased during the period of the war to \$100 to provide funds to carry on the greatly increased work of the association in handling the various problems growing out of wartime laws and regulations. With the passing of the emergency came the reduction of the dues, a move which was accepted most gracefully by the membership of the association at large.

After some discussion on general matters the meeting adjourned until Tuesday morning.

Much Important Business at Tuesday Morning Session

The convention session on Tuesday morning was devoted largely to the discussion of the several recommendations offered in the reports of the president and secretary, both in regard to matters to be taken up with the factory and



C. N. Andrews, Mrs. C. N. and W. D. Andrews other matters concerning the actual business of wholesaling machines and records. All the recommendations made by the officers were accepted and approved by the association as a whole, and their carrying out was left in the hands of the incoming executive committee.

Suggests Votes for Washingtonians

E. H. Droop, of E. F. Droop & Sons Co.,

Washington, together with W. R. Roberts, of the same house, brought before the association the question of securing the voting privilege for residents of the District of Columbia. As is generally known, residents of the district have no say by vote in the conduct of the Government, and a move is on foot to give them this right.



A. Davega and B. R. Forster

It was the consensus of opinion of the association members that the movement should be regarded favorably, but no definite action was taken.

Endorse Victor Co. War Policy

E. H. Droop presented to the association a resolution, adopted promptly and unanimously, supporting and approving the policy of the Victor Co. during the period of the war in turning over their manufacturing facilities to the Government for war purposes. The resolution was accepted as expressing most admirably the sentiments of the entire association.

Business Men and the Government

The association went on record as being strongly in favor of the idea of business men generally taking a more active interest in national politics, for the protection and advancement of the business of the country generally.

The association in convention reaffirmed the sentiment already expressed to the effect that factory production must not be allowed to lag, but should be stimulated to the greatest degree possible, with the assurance that the trade will be able to absorb and distribute any possible increase of production of Victrolas and records. At the same time some encouraging reports were received regarding the present increase in Victor factory output.

Favor One-cent Postage Campaign

On motion of A. Hospe, of Omaha, the association went on record as favoring the campaign that has been conducted for some time past providing for one-cent postage on letters.

Atlantic City Again Next Year

There was the usual discussion regarding the place at which the 1920 convention is to be held, and, as usual, the sentiment was overwhelmingly in favor of returning again to Atlantic City, and this is the final decision. The exact date is left to the discretion of the executive committee.

Tellers Have a Busy Time

Considerable time during the morning was given over to the election of a new executive committee to preside over the destinies of the association during the coming year. It finally developed that twenty members had been nominated for the fifteen positions on the executive committee. A vote was then taken and the tellers disappeared ostensibly to count the votes to determine the result. Strict search was made but they were not found in time for the afternoon session.

(Continued on page 75)

SCHWARTZ LION HEART SPRINGS.

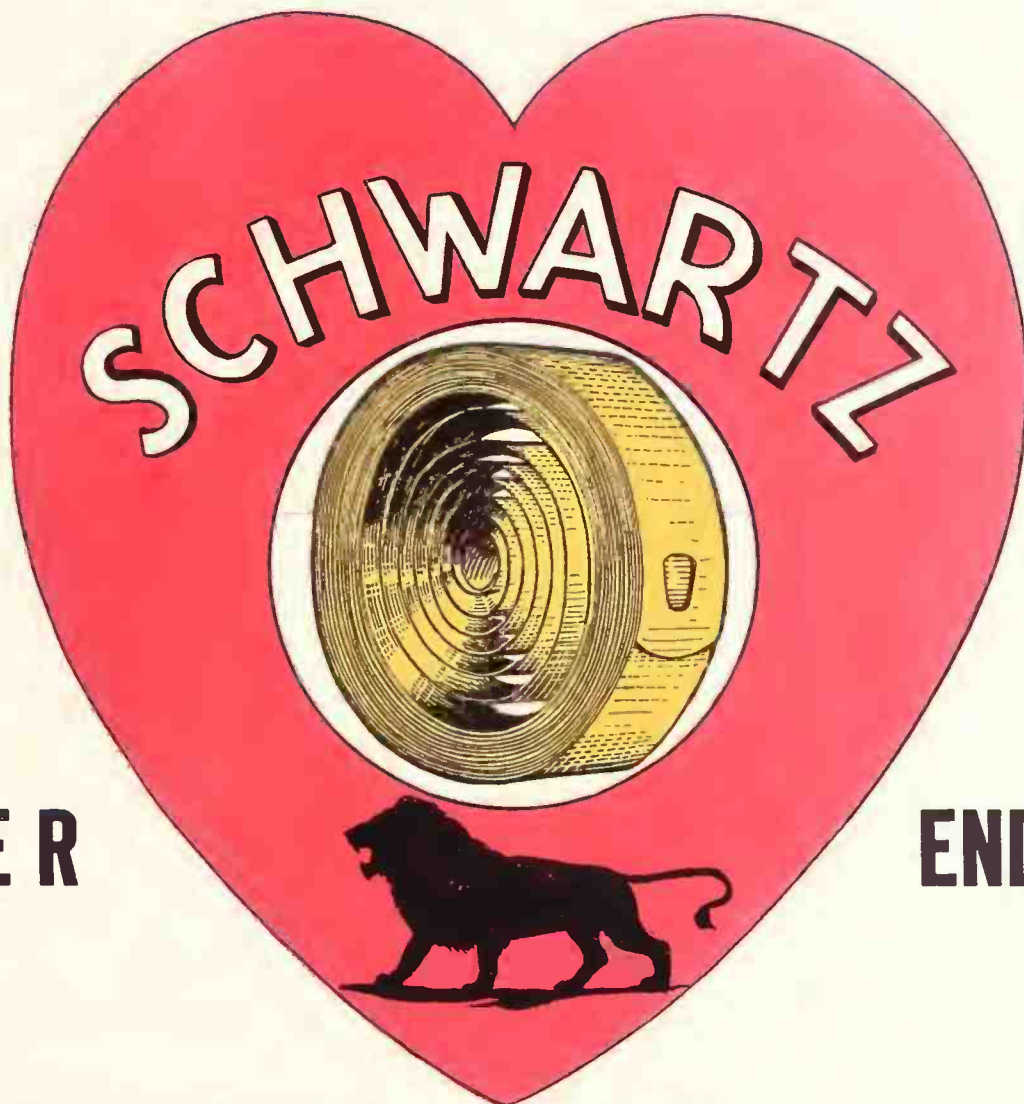

P O W E R

ENDURANCE

THE HEART

To win true success, to rise beyond the common herd, a MAN must possess POWER and ENDURANCE WITHOUT LIMIT. If not, he is a failure. To possess these qualities a man must have a LION'S HEART, the heart that never falters or misses a beat no matter what the conditions, and endures to the end, pulsating with power when others have ceased being. A weak HEART is sure failure.

THE SPRING

As with a MAN so with the talking machine. Its motor must possess POWER and ENDURANCE WITHOUT LIMIT to be a true SUCCESS, to rise beyond the common herd. Otherwise it is a FAILURE. To possess these qualities it must be equipped with SPRINGS that never falter or miss no matter what the conditions, and endure to the end, pulsating with power when others have ceased being. SPRINGS possessing the LION HEART QUALITY do this. YOUR TALKING MACHINE is NO BETTER than its Springs. A weak spring is sure FAILURE.

SCHWARTZ-LION HEART SPRINGS

embody everything their name implies. They will give more power, wind for wind, than any other make, and continue to do so indefinitely, without any deviations. Send us your specifications. We will send you samples. You are the sole judge as to their quality.

SCHWARTZ HERRMANN STEEL WORKS INC.

CHICAGO

JOHN W. GAGE MGR.
817 WASHINGTON BLYD.
TEL. MONROE 6733

OFFICES WORKS
SOMERVILLE,
NEW JERSEY

NEW YORK

JOS. E. VINCENT JR. MGR.
NO. 55 LIBERTY ST.
TEL. CORTLAND 5765

LIVELY GENERAL CONVENTION OF VICTOR JOBBERS AT ATLANTIC CITY—(Continued from page 74)

Victor Officials Speak At Tuesday Afternoon Session

The final session of the convention on Tuesday afternoon was given over chiefly to a series of interesting talks by various officials of the Victor Co., although the question of determining the new officers was first settled, they being chosen from among the members of the executive committee as follows:

The New Officers

President, George E. Mickel, Mickel Bros. Co., Omaha, Neb.

Vice-president, Thomas H. Green, Silas E. Pearsall Co., New York.

Secretary, A. A. Trostler, Schmelzer Arms Co., Kansas City, Mo.

Treasurer, W. H. Reynolds, Reynolds Music House, Mobile, Ala.

In addition to the four officers named the executive committee includes: James F. Bowers,

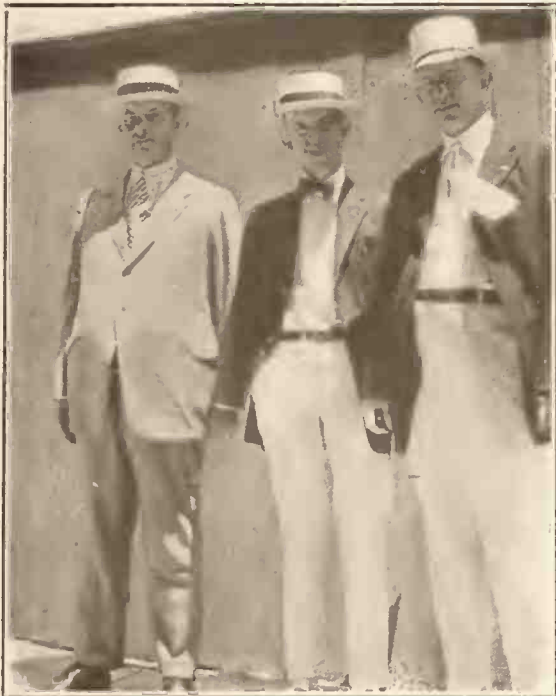

A. A. Grinnell, C. H. Grinnell and George Martin Lyon & Healy, Chicago; P. B. Whitsit, the Perry B. Whitsit Co., Columbus, O.; J. C. Roush, Standard Talking Machine Co., Pittsburgh; J. N. Blackman, Blackman Talking Machine Co., New York; Louis Buehn, Louis Buehn Co., Philadelphia; Daniel Creed, Chicago Talking Machine Co., Chicago; A. A. Grinnell, Grinnell Bros., Detroit; Andrew J. McCarthy, Sherman, Clay & Co., San Francisco; Burton J. Pierce, J. W. Jenkins' Sons Co., Kansas City, Mo., and H. A. Winkelman, Oliver Ditson Co., Boston.

This will be Mr. Mickel's second experience as president, he having held that chief office of the association during the year 1914-15. His past experience should insure the success of the administration.

Victor Co. Officials Talk

Perhaps the most interesting features of the convention were the addresses made by Ralph L. Freeman, secretary of the Victor Co.; Fred-



George E. Mickel

erick J. Staats, comptroller, and G. C. Child, director of the Recording Laboratories.

Mr. Freeman brought a most encouraging message to the wholesalers, and emphasized strongly the manner in which the Victor Co.



The Corley Co. Trio—Fred Kesnick, J. G. Corley and Frank Corley

had worked since the first of the year in bringing the factory production back on its old basis, a task that was now completed. He stated that the company had recovered from the war conditions more rapidly than any other concern of like size and which had been in a similar position. The goal of the Victor Co., however, he said, is not simply to get back to a pre-war

basis, but to go ahead with development work, and increase the output to meet the new demand that has grown for Victor products. Incidentally he outlined several new projects under way of distinct interest to both wholesalers and dealers, and which will be made public at the proper time.

Mr. Child for his part dwelt chiefly upon the record situation, and had some important announcements to make in that connection, and concerning moves now under way that should tend materially to increase the sales of Red Seal records. Mr. Child dwelt strongly on the fact that the success of the Victor record business lies largely in the attitude of the trade themselves towards the records, and urged that the wholesalers show a true appreciation of the tremendous musical value of the records, how they tend to place the best of music within the reach of the most humble, and work out their campaign along those lines, with a view to keeping the talking machine on its proper plane.

Mr. Staats also had some interesting information to offer the wholesalers as to factory con-



Rudolph Wurlitzer, C. Alfred Wagner and J. G. Corley Getting the Sun

ditions, the outlook for the immediate and distant future, and various plans under way calculated to develop and increase Victor business and prestige.

At the conclusion of the talks by the Victor men several of the members of the association took occasion to discuss certain phases of the various questions brought up by the factory men, and present their views regarding sundry policies.

New President Installed

The new president, G. E. Mickel, was duly installed in office, and a vote of thanks was offered to the various retiring officers for their earnest work during the past two strenuous years, and their willingness to carry the burden of association duties during that period.

Tribute to Departed Members

At this point President Blackman called the
(Continued on page 77)

The Corley Company

**VICTOR WHOLESALERS
RICHMOND - VIRGINIA**

DITSON VICTOR BOSTON

DITSON VICTOR SERVICE embodies many features that are unusual and work to the advantage of the dealer directly.

There's a human side to the service that goes just a little beyond the ordinary wholesaler-dealer relationship

We cannot accomplish the impossible—make machines and records grow over night, for instance—but we can, and do, make the dealers' interests our interests—

Honestly and unselfishly.

To the dealers who use

DITSON SERVICE

that fact will mean much this fall and afterwards.

OLIVER DITSON COMPANY

178-179 TREMONT STREET
BOSTON, MASS.

CHARLES H. DITSON & CO.
NEW YORK



LIVELY GENERAL CONVENTION OF VICTOR JOBBERS AT ATLANTIC CITY—(Continued from page 75)

attention of the association to several prominent members who had been cut down by the Grim Reaper during the past year, and a standing and silent tribute was paid to their memory. The convention then adjourned, preparatory to the annual banquet, the closing event Tuesday evening.

Annual Banquet Tuesday Evening a Splendid Success

Despite the demise of John Barleycorn the preceding midnight, and his absence therefore from the tables at the annual banquet of the association on Tuesday night, that affair was a success in every particular, and measured up well with preceding events, even the members of the Anvil Chorus proving that with noise-making devices handy they could still be happy without the flowing bowl.

Those who came to enjoy the banquet in all seriousness had the privilege of listening to what was probably the most masterly address on the talking machine and its relation to music that has ever been delivered before the association, the address being by James M. Beck, noted jurist, former Assistant Attorney General, and at the present time counsel for the Victor Co.

After the banquet proper had been disposed of to the accompaniment of some lively singing by the Peerless Quartet, and solos by the old record favorites, Billy Murray, Henry Burr, Frank Croxton and Monroe Silver, maker of the "Cohen" records, J. Newcomb Blackman, the retiring president, introduced as toastmaster James F. Bowers, who presided in the same capacity at banquets, for, lo, these many years.

Mr. Bowers immediately proceeded to make some of the diners feel badly by bringing up the question of prohibition and its effectiveness, quoting liberally from prose and verse to substantiate his contentions. His reference to Omar, "a loaf of bread, a pitcher full of lemonade, and thou," met with quick response, and after repeating Kipling's words,

"And when it comes to slaughter
You'll do your work on water,
And lick the boots of him that's got it,"

the toastmaster proceeded with the introduction of the several speakers of the evening.

J. Newcomb Blackman's Address

The first speaker was J. Newcomb Blackman, the retiring president, who outlined some of the trials and tribulations of the association members during the past few years, how they have rallied to the support of one another, and patriotically to the support of the Government during the period of the war without ever hav-

ing lost confidence. He declared that now there was a rainbow on the horizon of business, and that the future was full of promise.

Charles K. Haddon, vice-president of the Victor Co., who was scheduled to speak, was compelled to be absent, due to the serious illness of a near relative.

The New President Introduced

The next speaker introduced was the new president, George E. Mickel, who after some humorous introductory remarks told of the responsibility of the future as it related to the Victor wholesaler, and how the call is now for



James F. Bowers

energetic and resourceful business methods. He emphasized the tremendous size of the company, whose products the wholesalers represent, and the high standing of those products, and declared that they must be marketed in the best possible manner in keeping with their standing.

R. L. Freeman's Message

At the conclusion of Mr. Mickel's address a standing toast was drunk in honor of Eldredge R. Johnson, president of the Victor Co., after which Mr. Bowers introduced Ralph L. Freeman, secretary of the Victor Co., to make his initial address at the association banquet. Mr. Freeman told of the manner in which the Victor Co. had recovered from the effects of war conditions, having made greater progress since January 1 in that direction than any concern of like size and similarly placed. He declared that with the factory and distributing forces working together there was in sight an unparalleled era of prosperity for the entire trade.

In closing his brief talk Mr. Freeman invited

the wholesalers to visit Camden on Wednesday and inspect the factory to see personally just what was being done to speed up the output for their ultimate benefit.

Letter From Louis F. Geissler

After Mr. Freeman's address the toastmaster read a letter from Louis F. Geissler, former general manager of the Victor Co., who, after extending greetings to the association members, expressed his regrets at being compelled to miss the banquet for the first time since the forming of the organization.

James M. Beck's Masterly Address

The feature of the evening was the wonderfully able and scholarly address of the Hon. James M. Beck, who is known to be a brilliant speaker, but surprised his most enthusiastic admirers with his talk on the talking machine and its relation to music. Mr. Beck declared that talking machine wholesalers, or many of them, did not fully appreciate the dignity of the work in which they were engaged. He declared that "talking machine" and other generic terms for music-reproducing apparatus did not begin to fully convey just what the product was designed to accomplish and did accomplish.

The "Printing Press of Music"

In making his point clear Mr. Beck coined a new term for the talking machine, the significance of which should not in any sense be lost on members of the trade. He termed it "the printing press of music," and declared that as the original printing press of Gutenberg had delivered the world from ignorance of the written word, bringing knowledge to the masses, instead of confining it to the few, so had the talking machine delivered the world from ignorance of music. While it is true, he said, that music is written, in that form it is understandable only to a comparatively small number. The talking machine, however, has taken this written music and interpreted it with all its wonderful meaning in a manner comprehensible to anyone able to hear.

Of music itself, and its history, Mr. Beck proved himself a profound student. He stated that music was known before language, and lived longer than language. He told how the "Marseillaise," written by a soldier of France, had survived and been recognized as the hymn of freedom and quality, while impassioned addresses of noted Frenchmen of the period were forgotten. The brilliant addresses of the period of the Revolution, with the possible exception of Patrick Henry's oration, were likewise forgotten, and yet the "Yankee Doodle" of the same period has survived, and still survives. By

(Continued on page 79)



SINCE JUNE 21st, 1912, WE HAVE BEEN

EXCLUSIVELY WHOLESALE



FOR SEVEN YEARS EVERY DOLLAR'S WORTH OF VICTOR MERCHANDISE THAT WE HAVE RECEIVED HAS BEEN TURNED OVER TO SOME VICTOR DEALER.

We pledge to Southern Victor Dealers a continuance of this policy, and our co-operation to the fullest extent in the development of their Victor business.

ELYEA COMPANY

EXCLUSIVELY WHOLESALE

ATLANTA



Meet Low-Price Competition with a High Grade Product

Lundstrom
CONVERTO

PATENTED DEC. 11, 1917

Talking Machine CABINET



Cheap, unknown cabinet machines attract customers solely by Low-Price. There is none of the basic confidence felt as with Victrolas for instance.

You can easily win customers with limited means away from such competition by offering genuine Victrolas, small models, in which they have full confidence, and Lundstrom Converto Cabinets. In this combination they get a cabinet-type machine that you and they know is reliable, at a LOWER price than cheap but unknown cabinet machines.

Most of the leading Victor Distributors handle the Converto Cabinet as a STANDARD product.

THE C. J. LUNDSTROM MFG. CO.
LITTLE FALLS, N. Y.

Lundstrom "Converto" cabinets are broadly covered by patents. Infringements will be promptly prosecuted.

**Converto
Distributors**

Atlanta, Ga. Phillips & Crew Piano Co.
Austin, Tex. The Talking Machine Co. of Texas.
Baltimore, Md. Cohen & Hughes
E. F. Droop & Sons Co.
Birmingham, Ala. Talking Machine Co.
Boston, Mass. The Eastern Talking Machine Co.
Oliver Ditson Co.
Buffalo, N. Y. W. D. & C. N. Andrews
Burlington, Vt. American Phonograph Co.
Butte, Mont. Orton Bros.
Chicago, Ill. Lyon & Healy
Cincinnati, O. The Rudolph Wurlitzer Co.
Cleveland, O. The Collister & Sayle Co.
The Eclipse Musical Co.

Columbus, O. The Perry B. Whitsit Co.
Dallas, Tex. Sanger Bros.
Denver, Colo. The Knight-Campbell Music Co.
Des Moines, Ia. Mickel Bros.
Elmira, N. Y. Elmira Arms Co.
El Paso, Tex. W. G. Walz Co.
Kansas City, Mo. J. W. Jenkins' Sons Music Co.
Schmelzer Arms Co.
Memphis, Tenn. O. K. Houck Piano Co.
Milwaukee, Wis. Badger Talking Machine Co.
Mobile, Ala. Reynolds Music House
Newark, N. J. Price Talking Machine Co.
New York, N. Y. Emanuel Blout
The Cabinet & Accessories Co., Inc.
Knickerbocker Talking Machine Co.

Omaha, Neb. Mickel Bros. Co.
Peoria, Ill. Putnam-Page Co., Inc.
Philadelphia, Pa. The George D. Ornstein Co.
Penn Phonograph Co., Inc.
H. A. Weymann & Son, Inc.
Pittsburgh, Pa. W. F. Frederick Piano Co.
C. C. Mellor Co., Ltd.
Standard Talking Machine Co.
Portland, Me. Cressey & Allen, Inc.
Providence, R. I. J. Samuels & Bro., Inc.
Richmond, Va. The Corley Co., Inc.
W. D. Moses & Co.
Sioux Falls, S. D. Talking Machine Exchange
St. Paul, Minn. W. J. Dyer & Bro.
Syracuse, N. Y. W. D. Andrews Co.
Toledo, O. The Toledo Talking Machine Co.
Washington, D. C. Cohen & Hughes.
E. F. Droop & Sons Co.

LIVELY GENERAL CONVENTION OF VICTOR JOBBERS AT ATLANTIC CITY—(Continued from page 77)

taking music, therefore, robbing it of its mystery, and presenting it through the medium of records, in a manner understandable to the millions, talking machine manufacturers and their wholesalers, even though they may view the project solely as one of business, are nevertheless working for the benefit and uplift of humanity.

Then in addition to printing the music in understandable form for the ears of the masses, making it as comprehensible to the ear as the printed word is to the eye, said the speaker, the talking machine has enabled the noted singers of the day to be heard by millions of people all over the world, more people than they could

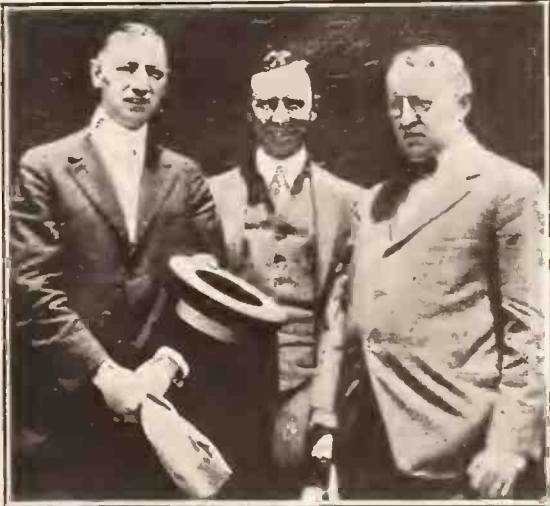

J. Elliott Clark, Ross P. Curtice and Geo. A. Mairs

appear before personally in a lifetime, if they sang before audiences of thousands nightly. The great singers of the past were known by reputation only to the masses, and personally to a comparative few. The voice of Caruso, in all its brilliance, however, is familiar to millions, in all parts of the world, familiar only because the talking machine makes it possible. Memories of the voices of other great artists have died with them, but through the talking machine Caruso's voice will be known and remembered through the centuries, declared Mr. Beck.

Speaking smoothly, quietly, the speaker held his audience spellbound for the better part of an hour, but out of the address there came one gem of thought, "the printing press of music."

At the conclusion of the speaking dancing was enjoyed until a late hour.

Those in Attendance at the Convention

The attendance at the convention came close to breaking all previous records, not, perhaps, from the number of individuals who were present, but from the number of concerns who had sent delegates. There were few of the old faces missing, but instead of being accompanied by delegations, as in previous years, the heads of the companies came alone or with their wives. Some companies proved more or less liberal in providing nice seashore vacations for several of their staffs. The Droop delegation from Washington, for instance, consisted of five members.

Members of the association represented at the convention and their delegates were:

American Talking Machine Co., R. H. Morris; Andrews Music House, W. H. Andrews and M. T. Jordan; W. D. & C. N. Andrews, Buffalo, Mr. and Mrs. C. N. Andrews; W. D. Andrews, Syracuse, W. D. Andrews; Badger Talking Machine Co., S. W. and H. A. Goldsmith; Blackman Talking Machine Co., Mr. and Mrs. J. Newcomb Blackman, Albert Blackman, Mr. and Mrs. P. Oliver; Emanuel Blout, Mr. and Mrs. E. B. Blout and daughter, and Mr. and Mrs. D. B. Riddell; C. Bruno & Son, Charles B. Bruno; Louis Buehn Co., Mr. and Mrs. Louis Buehn, and Mr. and Mrs. W. T. Nolan; W. H. Buescher & Sons Co., F. W. Buescher; Buffalo Talking Machine Co., Mr. and Mrs. O. L. Neal and Mr. and Mrs. V. W. Moody; E. J. Chapman, M. L. Wells; Chicago Talking Machine Co., G. P. Ellis; John Elliot Clark Co., John Elliot Clark; Cohen & Hughes, Baltimore, Mr. and Mrs. I. S. Cohen and the Misses Evelyn, Elizabeth and Cecile Cohen; Cohen & Hughes, Washington, Mr. and Mrs. F. S. Harris; Collister & Sayle, F. C. Larter and L. H. Dorn; The Corley Co., Mr. and Mrs. J. G. Corley, F. W. Corley, and Frank Kesnich; Cressey & Allen, C. B. Snow; Ross P. Curtice Co., Ross P. Curtice and C. R. Moores; Knickerbocker Talking Machine Co., A. Davega and Richard Veale; Charles H. Ditson & Co., Mr. and Mrs. P. E. W. Carlson; Oliver Ditson Co., Mr. and Mrs. H. A. Winkelman; E. F. Droop & Sons, Baltimore, W. C. Roberts; E. F. Droop & Sons, Washington, E. H. and Carl Droop, W. A. Lyman and C. Hauser; W. J. Dyer & Bro., G. A. Mairs; Eastern Talking

Machine Co., C. A. Farnsworth, G. H. Dodge, and Herbert Shoemaker; Eclipse Musical Co., T. H. and P. J. Towell and Charles K. Bennett; E. R. Eisenbrandt, Mr. and Mrs. W. A. Eisenbrandt and the Misses Alice and Eloise; Elmira Arms Co., J. W. Butts; Elyea Co., Mr. and Mrs. E. N. Upshaw; Florida Talking Machine Co., W. M. Edwards; W. F. Frederick Piano Co., Mr. and Mrs. G. H. Rewbridge and Mr. and Mrs. Benjamin Boycott; Gately-Haire Co., Mr. and Mrs. John Gately; Grinnell Bros., A. A. and C. H. Grinnell and George Martin; C. J. Heppe & Son, F. J. Heppe and W. T. Ellwell; Horton-Gallo-Creamer Co., E. C. Gallo; A. Hospe Co., A. Hospe; O. K. Houck Piano Co.,



W. C. Dierks, P. T. Evans and P. W. Simon, a Pittsburgh Crew

J. F. Houck and L. W. Pitts; J. W. Jenkins' Sons Music Co., Mr. and Mrs. Burton J. Pierce; Knight-Campbell Music Co., C. H. Arbenz; Koerber-Brenner Co., Mr. and Mrs. C. B. Gilbert; Landay Bros., Mr. and Mrs. Max Landay, and Mr. and Mrs. James Landay; Lit Bros.; Frederick Loeser & Co., Mr. and Mrs. E. Paul Hamilton; Lyon & Healy, James F. Bowers and L. C. Wiswell; C. C. Mellor Co., W. C. Dierks, Mr. and Mrs. J. C. Fischer and P. T. Evans; Mickel Bros., Des Moines, W. P. Deal; Mickel Bros., Omaha, George E. Mickel, Miss Gladys Mickel and G. E. Mickel, Jr.; Musical Instrument Sales Co., C. A. Wagner and C. R. Wagner; New York Talking Machine Co., Hugh C. Ernst and R. J. Keith; Ormes Inc., R. Wolf and C. L. Price; George D. Ornstein Co., George D. Ornstein; Silas E. Pearsall Co., Mr. and Mrs. Thomas F. Green; Penn Phonograph Co., T. W. Barnhill; Phillips & Crew Piano Co., M. C. Robson; Price Talking Machine Co.; Putnam-Page Co., Roy Page and Mr. and Mrs. Fred. H. Putnam; Reynolds Music Co., W. H. Reynolds; Robert C. Rogers, Mr. and Mrs. R. C. Rogers; Sanger Bros., Lester Burchfield; Schmelzer Arms Co., C. J. Schmelzer and A. A. Trostler; Standard Talking Machine Co., J. C. Roush, French Nestor and W. H. Russell; M. Steinert & Son, A. E. Reed; Stewart Talking Machine Co., Mr. and Mrs. A. M. Stewart, George Stewart and James Stewart; Talking Machine Co., Austin, Tex., Mr. and Mrs. A. E. Swan; Talking Machine Co., Birmingham, A. R. Boone; Talking Machine Co., Philadelphia, Mr. and Mrs. A. M. Stern and Mr. and Mrs. H. A. Ellis; Toledo Talking Machine Co., W. L. Kellogg and C. H. Womeldorff; W. G. Walz Co., W. G. Walz; Philip Werlein, Ltd., Parham Werlein and J. G. Moore; H. A. Weymann & Son, Mr. and Mrs. H. W. Weymann and Mr. and Mrs. A. C. Weymann; Perry B. Whitsit Co., Mr. and Mrs. P. B. Whitsit and Mr. and Mrs. W. F. Davison; G. T. Williams Co., G. T. Williams; Rudolph Wurlitzer, Chicago, L. V. Noble, and the Rudolph Wurlitzer Co., Cincinnati, Rudolph Wurlitzer.

GRINNELL
SERVICE

THE DAWN OF PEACE

Music, which played such an important part in winning the World's freedom, returns once more to its natural sphere, inspiring men to deeds of more exalted usefulness.

VICTROLAS and VICTOR RECORDS will be the vehicles which will play the greatest parts in restoring once again the World's balance.

Send Your Next Order to **Grinnell Bros.**

Let GRINNELL Service assist you in establishing Peace upon Earth and Good Will Towards Men.

VICTOR WHOLESALEERS
CORNER
FIRST and STATE STS.
DETROIT

QUALITY LEADERS IN THE CABINET FIELD



Style 71.—Mahogany, Golden Oak, Fumed Oak, Weathered Oak. Height 33 3/4 in. Top 17 1/2 x 17 1/2 in. Holds 168 12-in. Records. For Victrolas IV-A and VI-A; Columbia No 25 and No. 35.



Style 24.—Mahogany, Golden Oak, Fumed Oak, Weathered Oak. Mahogany has Mahogany front door; Oak has Quartered Oak front door. Height 33 in. Top 17 x 17 in. Holds 168 12-inch Records. For Victrolas IV-A and VI-A; Columbia No. 15, No. 25, No. 35.



Style 72.—Golden Oak, Fumed Oak, Weathered Oak. Height 34 in. Top 16 1/4 x 20 in. Holds 180 12-in. Records. Made specially for Victrola VIII-A. Top has countersunk holes to accommodate rubber bumpers on machine.



Style 86.—Mahogany, Golden Oak, Fumed Oak, Weathered Oak. Height 30 in. Top 19 1/4 x 22 3/4 in. Holds 96 12-in. Records. For Victrola IX-A; Columbia No. 50; Pathé No. 50.



Style 79.—Mahogany, Golden Oak, Fumed Oak, Weathered Oak. Height 34 in. Top 19 1/4 x 22 3/4 in. Holds 96 12-in. and 96 14-in. Records. For Victrola IX-A; Columbia No. 50; Pathé No. 50.



Style 32.—Mahogany, Golden Oak, Fumed Oak, Weathered Oak. Height 30 in. Top 24 x 20 in. Holds 126 12-in. Records. For Victrolas VIII-A and IX-A; Columbia No. 50; Pathé No. 50, and smaller machines.

Prompt deliveries on all orders. Write for Illustrated Catalog of complete line

The Geo. A. Long Cabinet Company

HANOVER, PA.

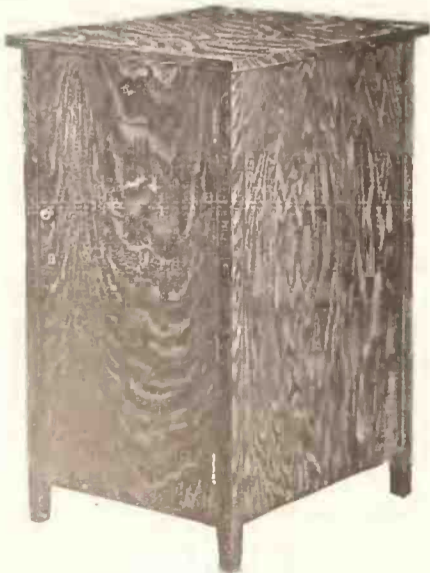

Style 76.—Mahogany, Golden Oak, Fumed Oak, Weathered Oak. Mahogany has Mahogany front door; Oak has Quartered Oak front door. Height 34 in. Top 19 1/4 x 22 3/4 in. Holds 96 12-in. and 96 14-in. Records. For Victrola IX-A; Columbia No. 50; Pathé No. 50.

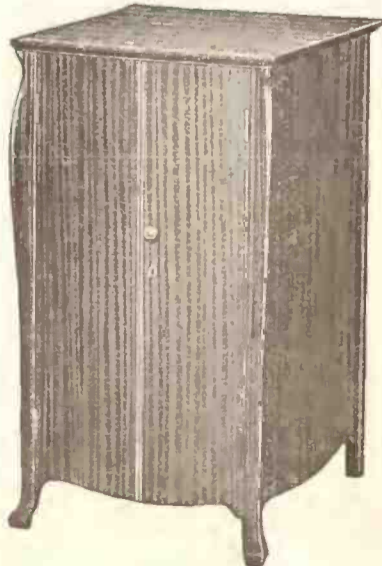

Style 77.—Mahogany, Golden Oak, Fumed Oak, Weathered Oak. Height 34 in. Top 19 1/4 x 22 3/4 in. Holds 96 12-in. and 96 14-in. Records. For Victrola IX-A; Columbia No. 50; Pathé No. 50.

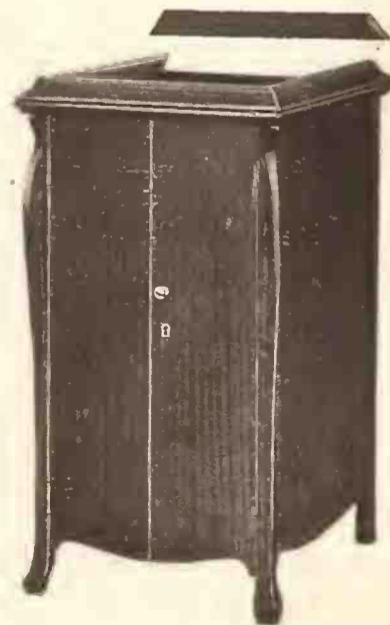

Style 77.—Shows cabinet equipped with top moulding to be used only in connection with Victrola IX-A.

LIVELY GENERAL CONVENTION OF VICTOR JOBBERS AT ATLANTIC CITY—(Continued from page 79)

SPLENDID ENTERTAINMENT GIVEN JOBBERS BY VICTOR CO.

After a Visit to the Factory Victor Jobbers Are Guests at Special Concert Given at the Little Theatre, Philadelphia, Followed by a Dinner and Dance—Great Array of Artists

On Wednesday the members of the National Association of Talking Machine Jobbers were the guests of the Victor Co. on a tour of the factory in the afternoon, and at an elaborate concert at the Little Theatre, Philadelphia, in the evening, followed by a dinner, entertainment and dance in the roof garden of the Bellevue-Stratford Hotel.

The wholesalers and their families left At-

In the evening at 8 o'clock the guests adjourned to the Little Theatre and enjoyed an elaborate concert, at which Jascha Heifetz, John McCormack and Sophie Braslau were the featured artists, with the Victor Orchestra, led by Pasternack, appearing in several numbers. After an overture by the orchestra, under the direction of Josef Pasternack, Mr. Heifetz played several numbers in his exquisite style,

audience to their feet with his impassioned singing of Fay Foster's masterpiece, "The Americans Come." An encore number completed the program with the exception of some selections from "Eileen," played by the Victor Orchestra, whereupon Ed Droop, the gifted orator, arose and in glowing words expressed the gratitude of the Victor jobbers for the wonderful treatment accorded them by the artists, Mr. Child and the Victor Co.

From the theatre the party went to the Bellevue-Stratford, where during the service of an elaborate dinner in the Rose Room they were entertained by Joseph C. Smith and his orches-

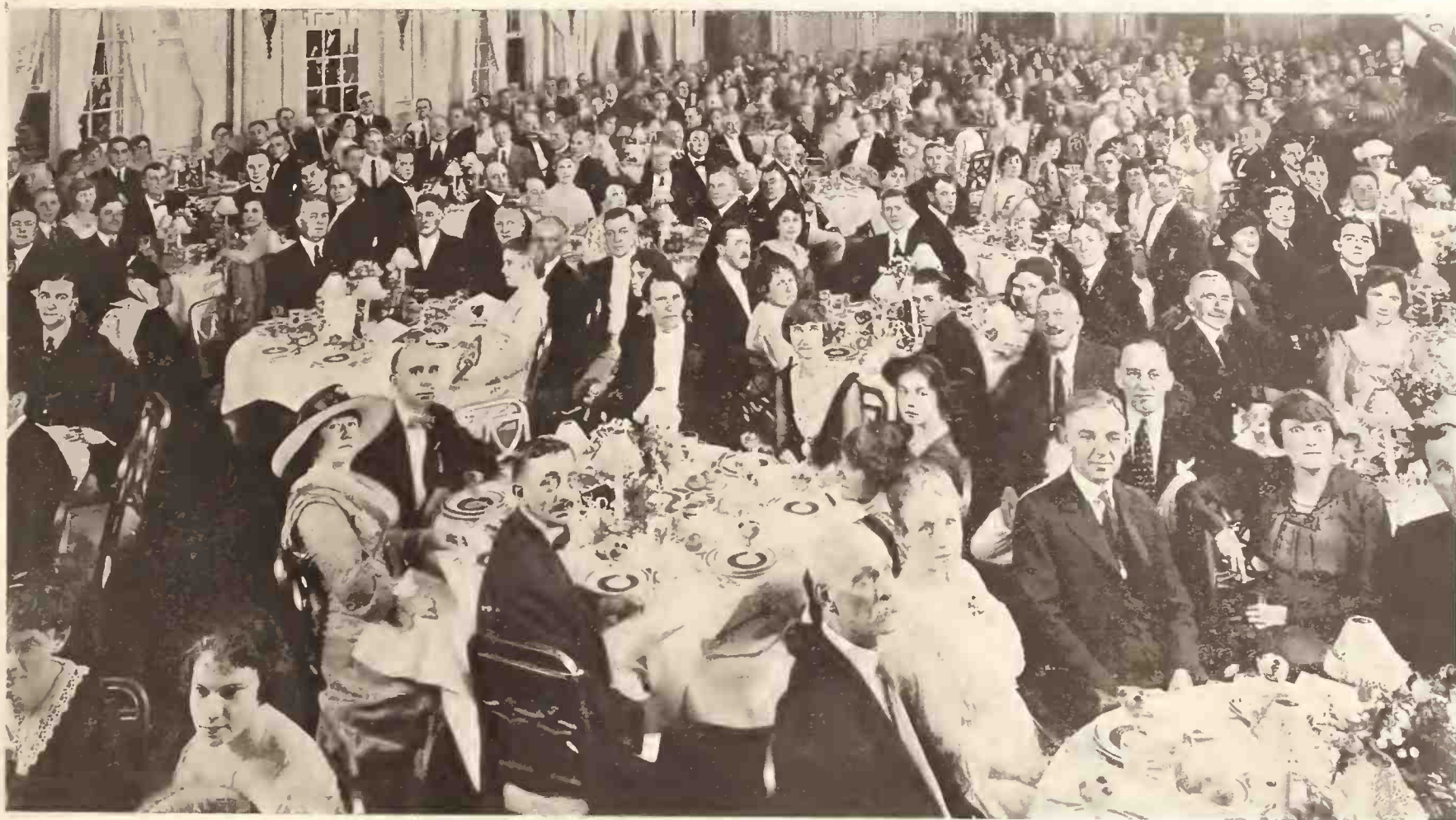

Banquet Tendered National Association of Talking Machine Jobbers by Victor Co., Philadelphia, July 2, 1919

lantic City after a swim in the morning and upon arriving at the Hotel Bellevue-Stratford, Philadelphia, found that accommodations had been arranged for them by the Victor Co. officials. They then visited the factory at Camden, where they witnessed some striking new models of the Victrola, of which due announce-

ment will be made later, and were taken on a tour of inspection through various departments of the immense plant of the company in order that they might see for themselves just what strenuous efforts were being put forth in every department to speed up production. As many of the wholesalers remarked, the Victor factory had never looked busier, with every section of the plant under full headway.

among them being a nocturne in E minor by Chopin, a rondo by Mozart, a Slavonic dance in E minor by Dvorak-Kreisler and a series of Gypsy airs by Sarasate. In answer to the enthusiastic applause he gave several enjoyable encores. Miss Braslau sang a sacred number, "Father, Why Hast Thou Forsaken Me," most impressively, singing a lighter number as an encore. John McCormack, after an opening number by Donizetti, aroused his audience with a beautiful rendition of "Dear Old Pal of Mine," one of the favorite songs of the day, and an Irish ballad by Moore. He then brought many of the

tra, the Criterion Quartet, the Misses Holt and Rosedale, Billy Murray and Ed Smalle, Victor Herbert, the Van Eps Trio, Pietro Deiro, Miss Adele Rowland and several other popular artists associated with the Victor recording staff.

Dancing on the Bellevue-Stratford roof garden



John McCormack

ment will be made later, and were taken on a tour of inspection through various departments of the immense plant of the company in order that they might see for themselves just what strenuous efforts were being put forth in every department to speed up production. As many of the wholesalers remarked, the Victor factory had never looked busier, with every section of the plant under full headway.



Miss Sophie Braslau



Jascha Heifetz

to the accompaniment of Smith's Orchestra and the Van Eps Quintet served to round out a perfect day, perfect with entertainment of the inimitable Victor style and likewise proved a fitting finale to the varied convention activities, both in Atlantic City and in Philadelphia.

LIVELY GENERAL CONVENTION OF VICTOR JOBBERS AT ATLANTIC CITY—(Continued from page 81)

VICTOR CONVENTIONITES TRY THEIR SKILL AS AVIATORS

Airplane Flights Attract the More Adventurous, While Sailing, Automobiling and Bathing Parties Add to the Enjoyment of Those in Attendance at the Atlantic City Meeting

As is usually the case at the Atlantic City conventions, the program of entertainment laid out by the Arrangements Committee was quite

afternoon, at the Airport. A substantial delegation of talking machine men and their ladies went out to the grounds to watch the flights,

gation appeared overanxious to repeat the experience.

On Tuesday at noon the ladies were taken in automobiles to the Sea View Country Club, where luncheon was served to them. Mr. Nolan



Mr. and Mrs. I. Son Cohen and Miss Cohen liberal in its scope, particularly in so far as it was planned to keep the time from hanging



Perry B. Whitsit Ready for a Flight

and several of them had the courage to take to the air in company with capable pilots. A. A. Trostler was picked out by the aviator to accompany him on an exhibition flight, and the next birdman who inveigles brother Trostler into the same predicament will have to work some. Suffice it that a few nose spins and a loop-the-loop or two do not help the digestive apparatus to any great degree. Others who took the opportunity of "flying" included Ralph L. Freeman, Parham Werlein, V. W. Moody, Perry B. Whitsit, Miss Cecile Cohen, Mrs. I. Son Cohen and A. Davega.

Whether it was the \$25 fee or the sensation is undetermined, but the fact remains that after a brief voyage in cloudland none of the dele-



Ralph L. Freeman, One of the "Aces"

again did the honors and this popular gentleman had fifty-three representatives of the fair sex under his wing.

The unofficial program was likewise long and interesting, including bathing parties, and particularly on the night of June 30 bands of pilgrims wandered in and out of the many oases on or near the Boardwalk and helped to dry them up. Also the roller chairs enjoyed their usual popularity, the sad sea waves lost none of their attractiveness for bathing purposes, at least, while the piers offered desirable entertainment, and a good time was had by all.

(Continued on page 83)



A. A. Trostler and V. W. Moody

heavily on the hands of the ladies, while their "worsen halves" were in the business sessions.



Parham Werlein as an Aviator

On Monday afternoon William T. Nolan, of the Louis Buehn Co., put on his gay garments,



Capt. Steele and A. Davega

grabbed a cane, and escorted the ladies in special buses to the Inlet, where a boat was started and a pleasant hour spent in sailing the high seas.

The big affair in the entertainment line, however, was the airplane flights later on Monday

Victor Wholesalers

Wholesale Only



We Are Nearly Ready

to give VICTOR dealers the great advantages of efficient Victor service made possible through the equipment embodied in our new headquarters—to which we will move the end of this month.

W.D. & C.N. Andrews
Buffalo, N. Y.

New Building



OTTO HEINEMAN PHONOGRAPH SUPPLY CO., Inc.

25 West 45th Street

New York City, N. Y.

FACTORIES: Elyria, Ohio Newark, N. J. Putnam, Conn. Springfield, Mass.
BRANCH OFFICES: Chicago, Ill. San Francisco, Cal. Toronto, Ont.

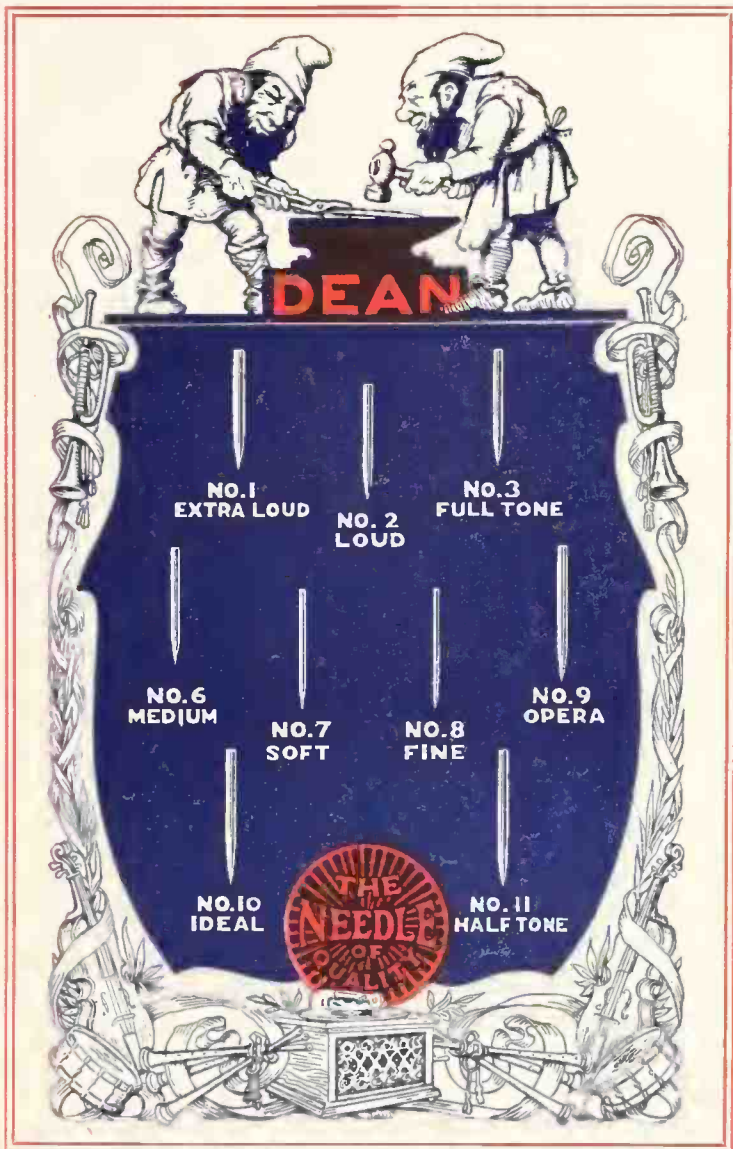

DEAN

For nearly a quarter of a century this name has stood for the highest quality of Phonograph Steel Needle.

Petmecky Multitone Steel Needle Plays Ten Records Perfectly

Three Different Tones

1. For **LOUD TONE**—Play with flattened side facing record.
2. For **MEDIUM TONE**—Play at intermediate angles.
3. For **SOFT TONE**—Play with edge facing record.

One Needle with three different tones

LOUD — MEDIUM — SOFT

Petmecky Multitone Steel Needle

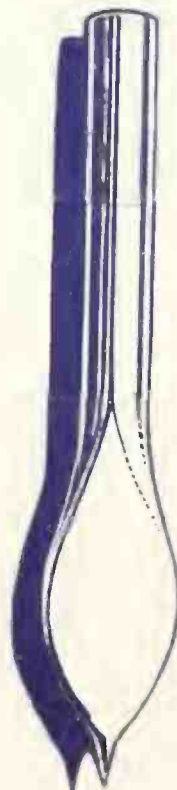

LIVELY GENERAL CONVENTION OF VICTOR JOBBERS AT ATLANTIC CITY—(Continued from page 82)

Heard in the Lobby of the Traymore

Atlantic City always proves a lodestone to talking machine men and their families and it is therefore to be expected that there will be a good showing from all sections of the country at the convention. Although the number in attendance was not so great as at some previous conventions, that fact did not interfere with everyone endeavoring to have the best possible time when not tied up by the convention sessions. The regular crowd knew just where to go and what to do to have the best time, and proceeded to carry out their ideas without delay. Some were so anxious to get into the swim that



The Ladies Outward Bound

they arrived two or three days before the convention opened. The balance kept right on arriving up to Tuesday night in time for the banquet. Owing to conditions covering railroad travel there was no attempt made to run special cars from New York or from the West, so some of the travelers made up special parties in order to break up the monotony of travel. The main thing is they all got there.

The threat that the country would go dry on July 1 stimulated the desire on the part of a score or more of our livest Victor jobbers to see the passing of the wet and the coming of the dry in proper style. The result was that a table for twenty was reserved in the Submarine Grille of the Traymore as far back as February, and a liberal deposit paid thereon. When the selected twenty on Monday night went down to enjoy the benefits of their foresight they found that there was plenty of room in the grille for probably 100 more who had not taken time by the forelock. Lack of a crowd did not interfere with the twenty enjoying the trip right up to the last moment. Some swore it was 2 A. M., others hesitated and the remainder declined to commit themselves. Besides the Submarine Grille all the leading resorts on or near the Boardwalk had their quotas of talking machine men and their ladies attending the wake of

John Barleycorn, mostly in the guise of spectators rather than participants. In so far as action went it is no secret to say that most of them were disappointed.

Pittsburgh claims to have had the biggest delegation at the convention and appears to be entitled to that distinction, the Standard Talking Machine Co. being represented by J. C. Roush, French Nestor and W. H. Russell, and the C. C. Mellor Co. by W. C. Dierks, Mr. and Mrs. J. C. Fischer and P. T. Evans. P. W. Simon, a live dealer of Uniontown, Pa., was also declared in on the delegation.

E. F. Droop & Sons, of Washington and Baltimore, also sent a very substantial delegation, including E. H. and Carl A. Droop, W. A. Lyman and C. Hauser, of the Washington headquarters, and W. C. Roberts from Baltimore. At Atlantic City that delegation spelled generosity.

One convention visitor introducing an accessory did not have to visit the Boardwalk to hunt up his party. Going to his room one evening to demonstrate his product to a wholesaler he opened the door to find three of the hotel maids dancing merrily to the music of his Victrola. The accessory man was game and insisted upon the girls staying and making a real party.

The broad scope of the association membership is indicated by the fact that there were present at the convention men from Maine and men from Hawaii, C. B. Snow from Portland,



The Schloss Brothers Arrive

for instance, and W. D. Adams from Honolulu. Florida, Texas and Illinois were also represented by native sons or successful visitors.

Never have rumors been so numerous at any convention as they were at the Atlantic City meet. To have accepted them all as founded on fact would have meant that the Victor Co., as well as every prominent wholesale house in the trade, is going to be reorganized. The

funny part of it was that some of those regarding whom the rumors were true denied them point blank, while those referred to in rumors that had no basis frequently looked guilty, and kept the scribes guessing. It can be said, however, that many surprising shifts are going to be announced very shortly. In fact, some of them are already announced in The World this month.

The Schloss Brothers, cabinet men, arrived in due course in Edwin Schloss's Hudson super-six. Incidentally Mr. Schloss found time to burn up the roads around Atlantic City just



The Ladies Ready for the Sail

to see what the car could do when pushed a little. On the straightaway it served to cure any desire to fly.

Sunburn lotion was at a premium with many of the convention visitors. The weather for a couple of days was pleasantly cool, and the bathers loitered on the beach without giving due regard to the fact that Old Sol was still on the job going strong. On Wednesday the sunburned element resembled a delegation of cripples.

On Tuesday afternoon one of the conventioners wandered into a cafe, with a thirst, in search of a highball. "Nothing but beer and wine," said the barkeeper; "that's orders." "Well, what about the bottle of whiskey I ordered this morning?" demanded the talking machine man. So good was his acting that he got away with the bluff and likewise the whiskey.

The ocean air and beautiful weather were not calculated to induce Atlantic City visitors to stay indoors, but nevertheless a few packs of cards being available some delegates were moved to closet themselves behind closed doors and give the call of the desert poker player to its mate, "Oh aces! oh aces!"

The convention received considerable attention in the columns of the local newspapers, as well as New York and Philadelphia dailies, through the efforts of George C. Kerr, publicity man of the Traymore. Brother Kerr has the

(Continued on page 86)

Exclusive Victor Wholesaling

ON A HIGHER PLANE OF CO-OPERATIVE SERVICE THAN HAS EVER BEFORE BEEN ATTEMPTED

We cordially invite all Victor Retailers and their organizations to visit our model Victor Wholesaling Establishment

Knickerbocker Talking Machine Co.

METROPOLITAN VICTOR WHOLESALERS

138-140 WEST 124th STREET

NEW YORK CITY

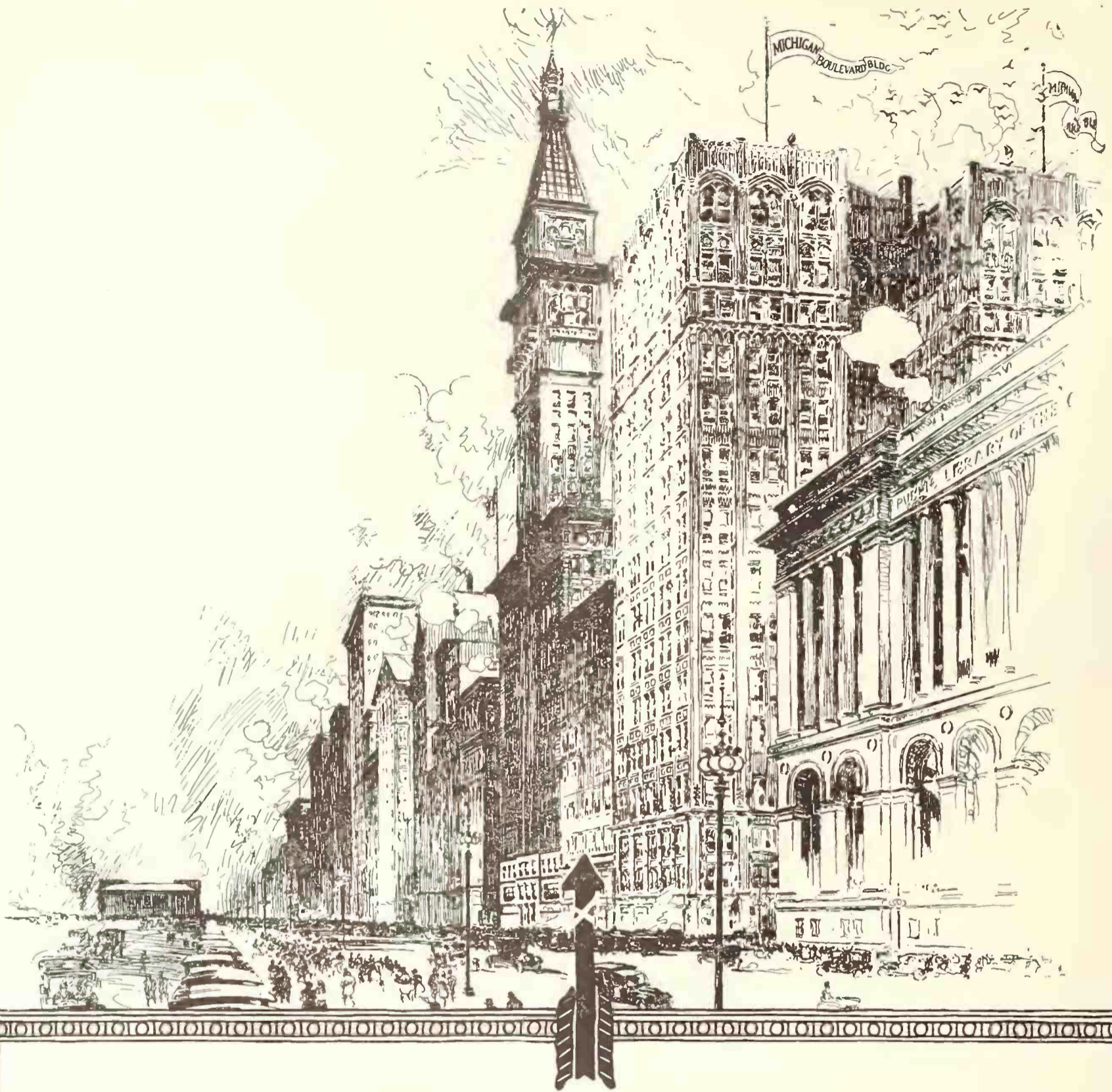

CHICAGO TALKING MACHINE CO.

*Exclusively a wholesaler of
Victor Talking Machines
Records and Supplies* 

12 North Michigan Ave. Chicago, Ill.

NEW YORK TALKING MACHINE CO.

*Exclusively a
wholesaler of
Victor Talking
Machines
Records and
Supplies*

119 W. 40th St.
New York City

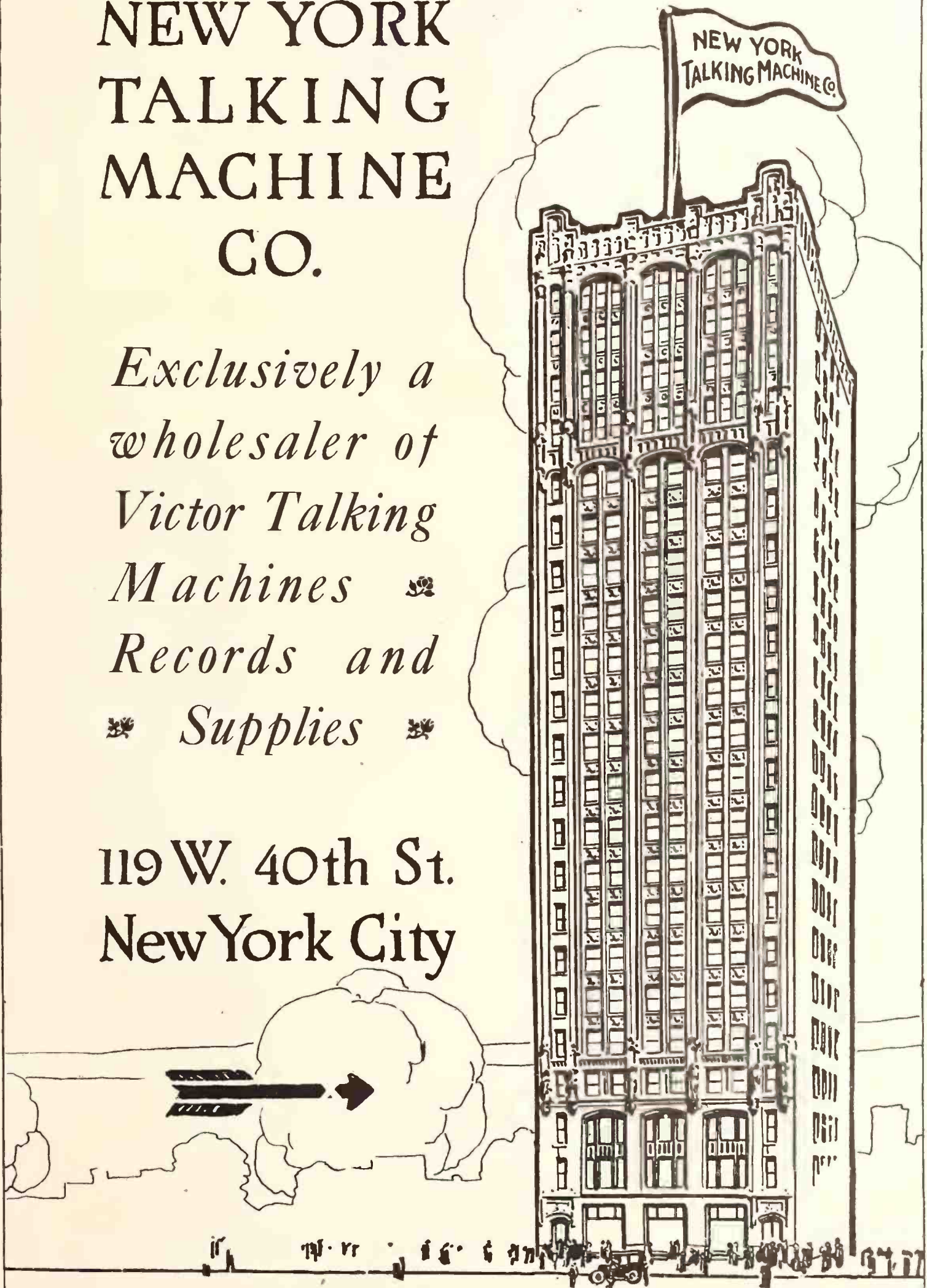

LIVELY GENERAL CONVENTION OF VICTOR JOBBERS AT ATLANTIC CITY—(Continued from page 83)

knack of making friends with newspaper men and in rendering them every assistance in the conduct of their business. The result is much free publicity for the Traymore.

Fortunately for some of the bachelors among the jobbers several of their contemporaries had the foresight to bring their daughters to the convention. I. Son Cohen, of Baltimore, and Mrs. Cohen, for instance brought three, and that fact served to make the dancing so much more interesting.

Fred P. Oliver proved one of the busy bees at the convention in helping Louis Buehn to see that the arrangements worked out properly. Meanwhile Wiswell and Trostler, who have had much to do in the past, simply posed around the lobby nonchalantly and carefree.

The talking machine men may, and did, advocate high-grade music and the exploitation of Red Seal records, yet it seems to take some real wicked jazz to make them show unusual pep.

At the Atlantic City conventions the jobbers usually have a day or two spoiled by J. Pluvius, but this year was the exception. If the committee had ordered the weather in advance they could not have selected any better.

Those self-confessed experts of the trade who can go around the course at par, or in one or two strikes below, were keenly disappointed when it was announced that after the tournament had been postponed from Saturday to the following Wednesday and then to Thursday there were too few players left to make a tournament worth while. Several jobbers who had been telling each other how good they were



All Aboard for Ocean Trip

fought duels on greens near Philadelphia and no prize cups were awarded.

Toastmaster Bowers' asides at the banquet were so delightful that banqueters were sorry when he started to introduce speakers. His usual dialogue of quotations with E. H. Droop were missing because Mr. Droop had gone home, but Ernest John proved a worthy substitute. It is said there is no subject known regarding which Mr. Bowers cannot quote

P. T. Evans, who accompanied the Mellor Co. delegation from Pittsburgh, is a real veteran of the great war. He went across as a member of an advance signal detachment of seventy-eight men, a part of the Twenty-eighth Division, and but eighteen members of the company came back. Eight members of the Pittsburgh talking machine trade, including Mr. Evans, were in the company, and only one of them was lost. The Twenty-eighth Division saw some hard fighting and Mr. Evans is privileged to discuss the war with authority.

It was a very peculiar fact that those who attended most of the heavy committee meetings were married men and that the meetings were mostly held during the evening. Another peculiar fact was that having disappeared after the

meeting the committeemen returned, some seeking large bills in exchange for bunches of small ones and other strolling to the desk to have checks cashed. It might have been a coincidence, but—

The evening of entertainment by the Victor Co. was well duplicated in point of quality by the very handsome concert program and the



S. Ernest Philpitt and W. C. Roberts handsomely engraved and embossed supper-dinner menu. Both were real works of art.

ACCESSORY MEN AT CONVENTION

Take Advantage of Opportunity to Meet Jobbers and Introduce New Lines

As has usually been the case at previous conventions, a goodly number of manufacturers and distributors of cabinets, needles and other talking machine accessories took occasion to visit Atlantic City during the convention of the National Association of Talking Machine Jobbers.

Among those seen around the lobbies of the Traymore were Clement Beecroft, of Philadelphia, who took occasion to display to the jobbers a new type of cabinet with a revolving record compartment, working almost automatically and which does away with the usual cabinet door. He also displayed the other specialties for which he is the representative.

B. R. Forster, of the Brilliantone Steel Needle Co., New York, was also there with some interesting samples and the glad hand.

Otto Goldsmith, of the Cabinet & Accessories Sales Co., New York, was also much in evidence to tell about the merits of the Lundstrom cabinets and the other specialties he handles.

W. A. Condon, of Condon & Co., Inc., spent some time around convention headquarters and told those jobbers, not already familiar with them, something regarding the Torrington "Uniform" needles, for which his company is agent.

E. H. Lansing, the cover man from Boston, brought Mrs. Lansing with him and made a holiday of his visit.

Lewis C. Franc, of the Lu-Franc Sales Service Co., Detroit, took advantage of the opportunity of displaying to the jobbers his new special monthly series of record envelopes.

Phil Ravis, president of the Peerless Album Co., New York, looked the conventioners over, as did D. Tauber, president of the Progressive Phonograph Supply Co., New York, manufacturers of the Wall-Kane needles.

Edwin E. and Myron Schloss, of Schloss Bros., New York, the cabinet makers, motored down to the convention city for the purpose of shaking hands.

Rayburn H. Smith, H. A. Dalley and E. E. Morton, of the Unit Construction Co., Philadelphia, the latter being the company's Chicago representative, were also seen about the Traymore during the convention period.

Jones-Motrola, Inc., New York, the New England Talking Machine Co., makers of the "Perfection" reproducers and other concerns were also represented.

GOLF CONTEST FOR BLACKMAN CUP

Although Formal Tournament Is Postponed a Number of Jobbers Enter Contest With the Handsome Blackman Cup as Prize—Regular Tournament Postponed Till Next Year

Although the official golf tournament to be held in connection with the convention of the National Association of Talking Machine Jobbers was postponed for a year, owing to the fact that it was found impractical to hold it either in Atlantic City or Philadelphia, due to conflicting circumstances, a number of the jobbers decided to enter into contest for the handsome cup offered by J. Newcomb Blackman, retiring president of the Association, and the match was played off at the Old York Road Country Club, Jenkintown, Pa., near Philadelphia, on Tuesday morning.

Throughout the playing of the entire tourney a closeness of scores made interest most keen, and it was not until the last few holes were played that A. C. Middleton and Burton J. Pierce forged ahead of the others. The final score found Mr. Middleton and Mr. Pierce tying for first place with the score of 79. Mr. Walz ran third with a score of 81, Mr. Buehn fourth with a score of 83 and Mr. Oliver followed next with a score of 85. Those who played were H. C. Middleton, director of the Victor Talking Machine Co.; Burton J. Pierce, of J. W. Jenkins' Sons, Kansas City, Mo.; Louis Buehn, of Louis Buehn Co., Philadelphia, Pa.;



The Blackman Cup

Elmer Walz, general manager of Cohen & Hughes, Baltimore, Md.; and Fred P. Oliver, vice-president and general manager of the Blackman Talking Machine Co.

In order that a final decision may be reached as to which of the two tallying the best scores may be awarded the cup for the coming year, a match will be played between Messrs. Middleton and Pierce at the first occasion when Mr. Pierce visits Camden. This eighteen-hole match will probably be played in the latter part of the summer, as Mr. Pierce expects to visit the city again at that time.

The cup offered by Mr. Blackman, who is the retiring president, is given with the idea that it should be played for every year until some lucky one has won it three times. The winner each year has the right only to hold it until the ensuing tournament of the next year, when the cup passes on to the next lucky one.

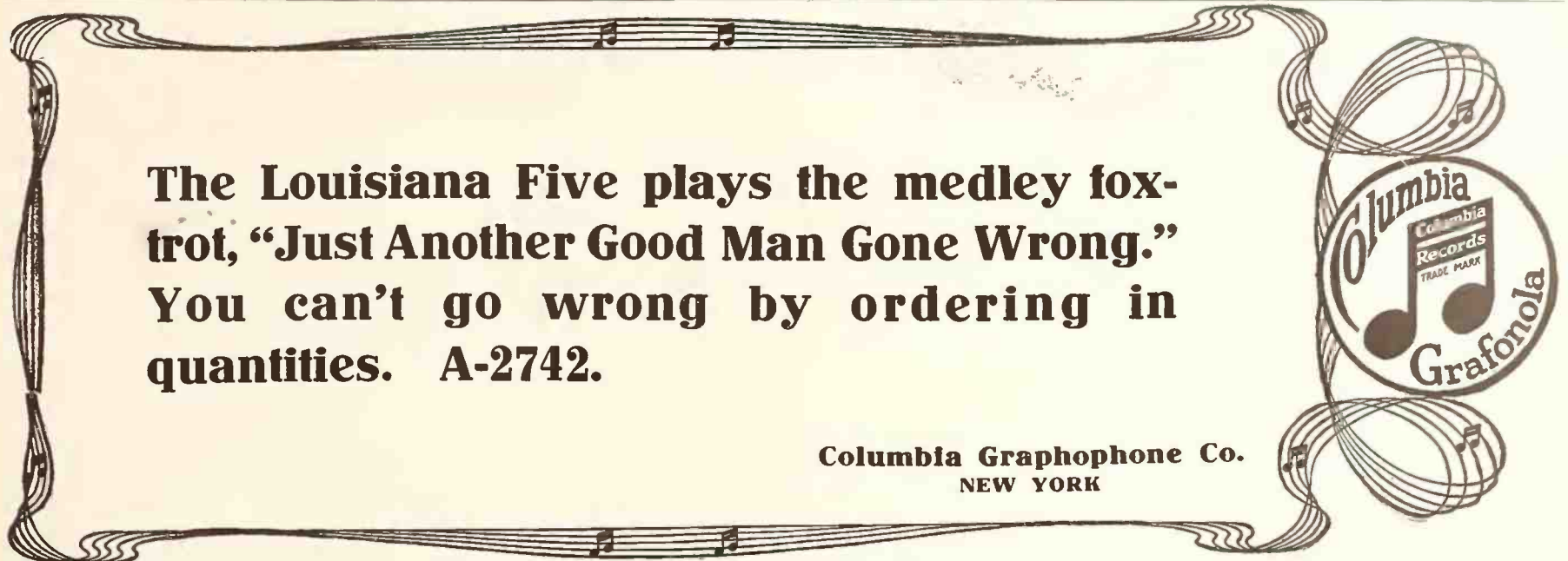

The Louisiana Five plays the medley fox-trot, "Just Another Good Man Gone Wrong." You can't go wrong by ordering in quantities. A-2742.

**Columbia Graphophone Co.
NEW YORK**

TWIN CITY TRADE PREPARING FOR HEAVY FALL BUSINESS

Work Begins on Elaborate New Home for Columbia Graphophone Co.'s Branch—Golden Rule Store's Victrola Department Enlarged—Vocalion Gaining Ground—General News

MINNEAPOLIS and ST. PAUL, July 7.—Hot weather brings no surcease from troubles to the talking machine dealer or distributor in the twin city territory. Their woes may not be quite as plentiful as they were some months ago, but they are numerous enough. Primarily the source of the general discontent lies in the inability of the manufacturers to supply both machines and records in quantities that will meet the persistent and constantly growing demand. To be sure, the general situation has eased considerably in the past few weeks, and the horizon of hope and encouragement is somewhat brighter. Preparations are being made, however, for a record trade in the late summer and fall, the magnitude of which will only be limited by the shipping facilities of the manufacturers.

Work was begun last week on the new Northwestern home of the Columbia Graphophone Co., 18-22 North Third street, Minneapolis. This will be a distributing center solely. Manager W. L. Sprague, Northwestern representative, will have 30,000 square feet of floor space at his disposal to begin with and will have in reserve an additional 20,000 square feet. The arrangements will be as complete and convenient as modern engineering skill can devise.

Work already is underway for the enlargement of the Victrola department in the Golden Rule Store, St. Paul. Manager J. L. Pofahl has been on a study tour of the East and will incorporate some of the ideas he gathered into the

plans for his new space. He will have about twenty demonstration booths, which will take care of the most of the 3,000 square feet allotted to him. Various other houses likewise are providing facilities for their talking machine departments.

The Aeolian-Vocalion after its fine start in the Northwest is getting a footing here and there through the active efforts of the Stone Piano Co., general distributors. Manager T. S. Leavitt, of the talking machine department in The Emporium, is completely satisfied with his new line.

More Sonoras, a great many more, could be sold in the Northwestern territory if the instruments could be obtained, says Sewell D. Andrews, manager of the Sonora department of the Minneapolis Drug Co. The improved baby grand model is finding many warm friends and all the Sonora dealers want them.

Minneapolis was represented by six "live wires" at the big Edison meet the last week in June. The party consisted of Laurence H. Lucker, Edison's Northwestern agent; H. E. Stinchfield, Joseph Lowy, George Compton and Captain Toppel, all of the Lucker organization, and Frank Gonyo, head of the talking machine department of the New England Furniture Co. Edison business in the cities and the country would be entirely satisfactory, but for one thing and that is—

George Mairs, head of the Victrola department of W. J. Dyer & Bro., St. Paul, and E. F.

O'Neill, of Beckwith-O'Neill, Minneapolis, have nothing to say. "What's the use?" they ask. "Everybody wants a Victrola."

Director E. L. Kern, of the Brunswick-Balke-Collender Co., is still away behind in his orders. The Brunswick machine is being extensively pushed both in St. Paul and Minneapolis.

Really, the only manager who is not coming forward with some lusty denunciation is Jay H. Wheeler, who supervises the Pathé department for the G. Sommers Co. He does not say that he has assembled as big a stock as he would desire, but believes that he will be able to satisfy the majority of his numerous patrons in the Northwest.

OUTING OF SCHLOSS BROS. FORCE

Employes of Cabinet Factory Enjoy Lively Day at Coney Island Resorts

Schloss Bros., the well-known cabinet manufacturers of New York, gave an outing to their employes and a number of guests on Friday, June 18. The entertainment included surf bathing, followed by a banquet, after which the party repaired to Steeplechase Park, where all the sports of that resort were indulged in. Various other pleasures were programmed and the gathering returned to the city after a day of much activity. The employes were taken to the beach in three large sightseeing cars.

The Alexander Victrola Store, 118 Broadway, Long Branch, N. J., has undergone improvements and several new soundproof booths have been added.



An Excellent List of Victor Records

**We Will Gladly Play
Any Record For You**

14779-15	He's in the Old Time (Mickey)	35
14780-15	Got I Let You Go (Mickey)	35
14827-15	Smart Little Dancer	35
14828-15	Humorous Round	35
14829-15	Let's All Sing	35
14830-15	What I Mean (Jack)	35
14831-15	Madly Love a Man	35
14832-15	Somebody's Love	35
14833-15	Madly Love a Man	35
14834-15	Somebody's Love	35
14835-15	Somebody's Love	35
14836-15	Somebody's Love	35
14837-15	Somebody's Love	35
14838-15	Somebody's Love	35
14839-15	Somebody's Love	35
14840-15	Somebody's Love	35
14841-15	Somebody's Love	35
14842-15	Somebody's Love	35
14843-15	Somebody's Love	35
14844-15	Somebody's Love	35
14845-15	Somebody's Love	35
14846-15	Somebody's Love	35
14847-15	Somebody's Love	35
14848-15	Somebody's Love	35
14849-15	Somebody's Love	35
14850-15	Somebody's Love	35



Art Series

Delivery
Envelopes

Jobbers get particulars—
Very attractive

Also Columbia, Edison and
Pathé lists of Records in
Art Series

RECORD
CABINETS

made with
Beecroft's Patent Moulding
Pat. No. 1,244,944

SOME NEW STYLES

Correspondence solicited

309 W. Susquehanna Ave.

CLEMENT BEECROFT

Philadelphia, Pa.

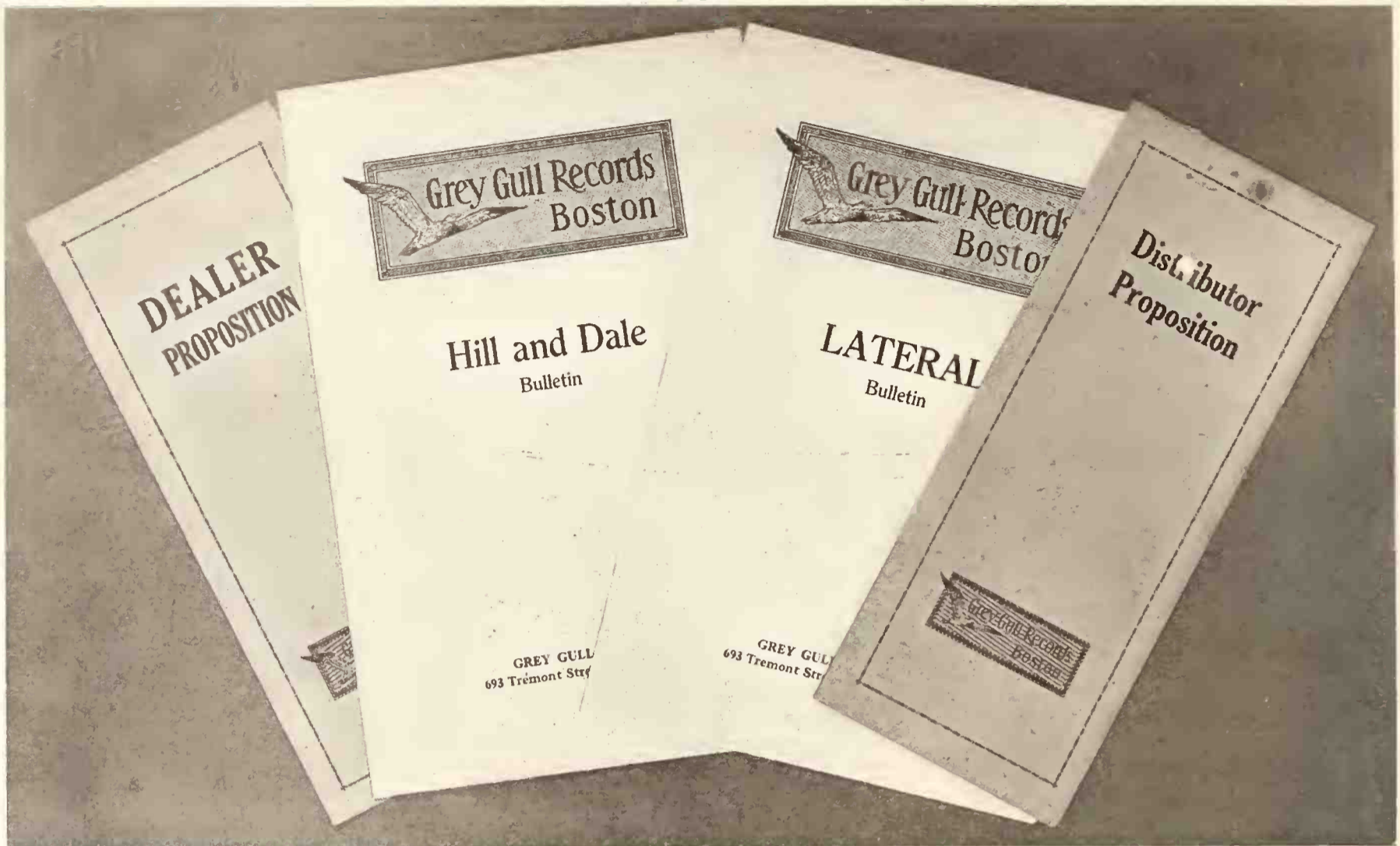

Free! Any or all of these leaflets will be sent to you in answer to a request on your business letterhead. There are no secrets about our terms to the trade.

Grey Gull Records are made attractive to you, *not* by unusually large discounts; nor by special concessions of *any* kind. They are made attractive to you because you are certain that *nobody* is buying them on better terms than those published; because they are beautifully recorded and cleanly printed; because they are made by a responsible, strongly financed concern; because you can be sure of getting your monthly quota promptly and regularly, this year, next year, five years from now and twenty years from now. Write us today, at 693 Tremont Street, Boston.



BIRMINGHAM DEALERS INTERESTED IN NEW ASSOCIATION

Southern Victor Dealers' Association to Have Hearty Support of Talking Machine Men in Alabama—Unico Booths in Demand—Plan Nine o'Clock Saturday Closing—Other News

BIRMINGHAM, ALA., July 3.—Victor talking machine dealers of this section were very much pleased to receive letters from the Elyea Co. Victor distributors, Atlanta, Ga., calling together all Victor dealers in convention in Atlanta on July 16 for the purpose of forming the Southern Victor Dealers' Association. The Elyea Co. have had this step under consideration for several years, but have held the matter up pending cessation of hostilities on the other side. From all reports the convention is bound to be a success as dealers from all sections of the South have signified their intention of attending. This is most certainly a big step forward for the Southern Victor dealer.

The Cable-Shelby-Burton Piano Co., of this city, are now busily engaged in making extensive alterations and additions to their talking machine department. Mr. Burton, the genial manager of this progressive house, has said that the talk-

ing machine department is to be his "pet department" and from the evident growth of the department Mr. Burton's remark is true.

H. Allen Dalley, vice-president of the Unit Construction Co., Philadelphia, spent several days in the city investigating the merits of Birmingham as a distributing point for "Unico" products. Mr. Dalley was very favorably impressed with conditions all through the South and reported having taken many orders for "Unico" equipment.

B. F. Bibighaus, representing the Victor Talking Machine Co., spent several days here during the month. Mr. Bibighaus had been spending some time in the smaller towns of Mississippi and expressed himself as pleasantly surprised on arriving in Birmingham and finding so many "live" dealers. Mr. Bibighaus did not confine his visits to Victor dealers, but managed to call, for a short visit, on every dealer here.

J. D. Moore, manager of the wholesale department of Philip Werlein, Ltd, New Orleans, was a visitor in Birmingham for several days. It was Mr. Moore's first visit to this city since his connection with Messrs. Werlein and it gave him an opportunity to meet personally many of his good customers in this section.

Mr. Dahlberg, of the Dahlberg Talking Machine Co., Montgomery, Ala., was a visitor in the city for several days and reported his business to be unusually good for this season of the year. Mr. Dahlberg does not devote any of his time to the business, but leaves it entirely in charge of one of the young ladies who has been with him some little time. His house handles the Victor line exclusively.

Mr. Ely, of the Pathé Frères, spent two days here last week in the interest of his house. Mr. Ely made a special trip to the city to take up important matters with the Haverty Furniture Co., which handles the Pathé line in its chain of stores throughout the South.

A. R. Boone, proprietor and manager of the Talking Machine Co., this city, left on Saturday for Atlantic City to attend the Victor Jobbers' Convention.

Victor Wan has left the J. E. Cain Furniture Co. and accepted the management of the phonograph department of F. W. Browning. Mr. Wan is effecting extensive alterations in the Third Avenue store and promises to give the Edison and Vocalion lines a representation henceforth that they will do credit to these products.

Miss Willie Cox, of the Clark & Jones Piano Co., is spending her vacation in Chicago, where she will spend some time with Lyon & Healy in their Victor Department. Miss Cox expects to visit also the Widdicomb factory in Grand Rapids. Miss Cox is known to the Birmingham public as the "Phonograph Girl." She has been engaged in the business for many years and has probably sold more talking machines and records than any woman in the South.

The Clark & Jones Piano Co. report, as usual, a tremendous business for the past month. The house has looked for a falling off of its business during the summer months, but with judicious advertising and concentrated effort on the part of the salespeople the firm reports an extremely good business for June.

During the past week the talking machine dealers of this city signed a petition to close their doors at nine o'clock on Saturday evenings. This is decidedly a step forward because heretofore many of the dealers had no specified time to close and it created confusion in the minds of the record-buying public.

Last week quite a little excitement was created by a fire on the mezzanine floor of the C. C. Holcombe Co. Plumbers were at work and a gasoline burner exploded and set fire to everything in a radius of ten feet. Several of the salesladies lost wraps and other belongings and slight damage was done to other material on the floor.

The Clark & Jones Piano Co. purchased last week two new trucks for the delivery of talking machines during the coming season.

Loveman, Joseph & Loeb have been featuring the new Edison cabinets in their advertising during the past month. The phonograph department of this house is very much more active since the installation of Mr. Golden as manager, and the coming fall promises to be a busy season.

The ACME of Perfection

in tone reproduction is attained in the ACME soundbox, because of its scientifically correct diaphragm construction which produces the real scientific sound waves.

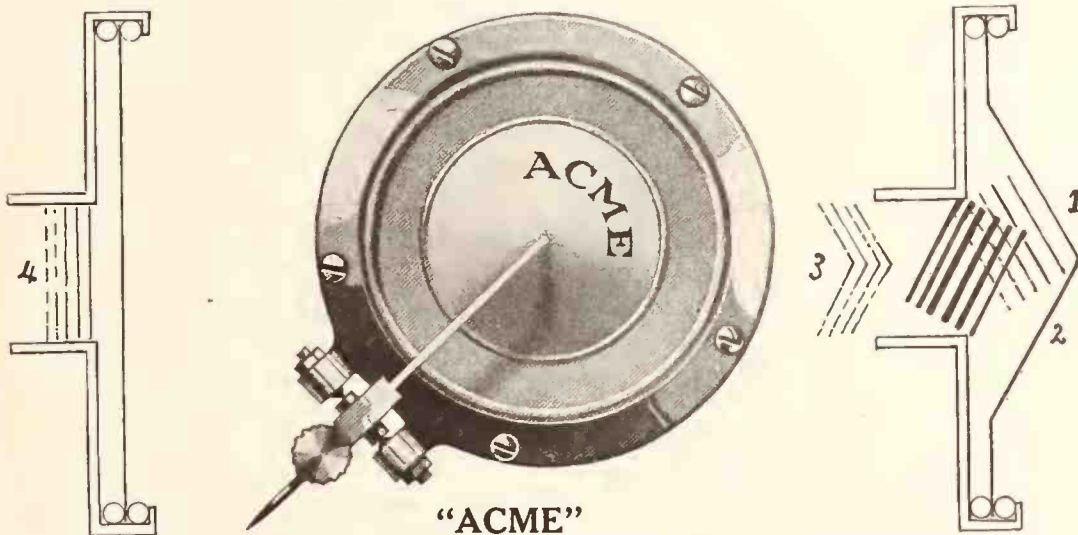

This illustration shows the short tone waves of the ordinary soundbox as used on most phonographs.

Nature's tone wave as produced by the ACME reproducer and approximately six times longer than tone waves of the ordinary soundboxes.

The result is an unmuffled NATURAL TONE of immense volume and an entire absence of that tin can, metallic tone of mica diaphragms. Made in Nickel and Gold to fit Victor, Columbia and Sonora.

**SPECIAL ATTACHMENTS to play
Victor and Columbia Records on
EDISON Machines**

Try an ACME reproducer for yourself. If not delighted you may return it. The price is right. Special inducements to live dealers and jobbers.

**ACME PHONOGRAPH CORPORATION
New York City**

46 Murray Street

Tel. Barclay 7633
7634

Write for our catalogues on phonograph hardware, motors, tone arms, records and accessories.

HIGHEST QUALITY LOWEST PRICES
COLE & DUNAS MUSIC CO.
54 W. LAKE STREET CHICAGO

WHAT HAVE YOU TO SELL?

We purchase in any quantity, anything you have for sale in the talking machine industry. The larger the quantity the better we like it. We can use cabinets, motors, tone arms, reproducers, springs, tabulators, micas, machine screws, wood screws, etc., etc., in job lots, or regular merchandise if the price is satisfactory. Get in touch with us on anything you have to sell.
LUCKY 13 PHONOGRAPH CO.
46 East 12th Street, New York

THE PROBLEM OF SUPPLY AND DEMAND IN CINCINNATI

Dealers Kept Busy in Trying to Make Two Factors Balance—New Machine Enters the Field—Big Convention of Columbia Dealers Held—Linking Up Records With Films—News of Month

CINCINNATI, O., July 3.—Getting ready for the fall and winter rush of business in the midst of unusual hot weather is the story of the retail and manufacturing trade of the Middle West. The merchants are not at all bothered about existing conditions, for the main question is to keep a satisfactory supply of selling records on hand.

P. H. Oelman, manager of the Phonograph Co., Cincinnati, was back at his desk Monday, following his attendance at the dealers' convention. While speaking highly of the usefulness of gatherings of this nature, Mr. Oelman's main thoughts were along the lines of a bounteous supply which is not forthcoming.

Holiday inquiries are being received at the Fritsch Phonograph Co., Canal and Main streets, where business is reported active.

Among the many out-of-town visitors to the local Columbia branch during the past two weeks were: George W. Hunter, Dayton, O.; E. C. Christian, of the Christian Music Co., Lexington, Ky.; Chester Fisher, Harrison, O.; Jacob Gordon, Butler, Ky.; Mr. Elmer Woodhead, Falmouth, Ky.; Mr. Shaffer, of A. R. Simpson Co., Hillsboro, O.; J. Margolis, of the Victor Furniture Co., Dayton, O.; Mr. Kramer, of the Sterling Jewelry Co., Dayton, O.; E. G. King, Williamsburg, O.; U. V. Walker, Owenton, Ky.; A. D. Kirk, Winchester, O.; A. R. Polasky, Georgetown, O.; J. J. Davis, Seaman, O.; W. T. Breeze, Brooksville, Ky.; C. L. Hutsiniller, of the Modern Drug Shop, Prestonburg, Ky.; Mr. Trapp, of Trapp & Gardener, Ripley, O.; Jeff Thompson, Lebanon, O.

"The Heart of Humanity," which played at the Lyric Theatre the past week, gave the Columbia dealers in Cincinnati an opportunity to tie-up with that film, by window displays, newspaper advertising, etc., and in that way sell more records of "The Heart of Humanity," which is

recorded by the Columbia Co. Also "The Red Lantern," which is playing this week at the Lyric Theatre, is receiving co-operation from the Cincinnati Columbia dealers. A. F. Greenwood, formerly of the Cincinnati branch, has resigned, and as yet no one has been assigned to succeed him.

F. F. Dawson, manager, has been visiting dealers in Kentucky the past week.

R. F. Bolton, sales manager of the International Record Department, has also been a visitor to the Cincinnati branch in the past week. Mr. Bolton gave some very good ideas about selling foreign records.

The big event of the Cincinnati branch this month was the Columbia dealers' convention, June 4 and 5. There were over 100 dealers present, including their sales people. Mr. N. B. Smith, assistant manager of the Cincinnati branch, had charge of the meeting, which was held in the assembly room of the Sinton Hotel, while Manager Dawson presided in the evening at a banquet in the grill room of the same hotel. The first meeting opened with a talk by Chas. Corday, manager of the Leo Feist Inc., on advertising. The talk of the evening was made by Geo. W. Hopkins, general sales manager of the Columbia Graphophone Co. C. K. Woodbridge spoke briefly about his branch of the business. The latter is connected with the Columbia Dictaphone.

The "Recall" will be the name of the product of the Huss Bros. Phonograph & Piano Manufacturing Co.'s factory, just being assembled at the northwest corner of Canal and Vine streets. It will be made in four sizes. The company will not be in quite shipshape for turning out goods under two weeks, according to C. C. Coppin.

Mrs. Janet Furniss has been spending considerable time with the Campbell Furniture Co., at Piqua, O., installing a new record system,

and is having wonderful success in her work.

Manager T. Sigman, of the Victrola department of the Rudolph Wurlitzer Co., is elated over the general trend of things in his territory. In speaking of business yesterday he said:

"The hot weather during the month of June did not affect the demand for talking machine goods, for the sale of Victrolas and records in our wholesale and retail departments was way over June of last year.

"Many small Victrolas, such as the \$25.00 and \$35.00 models, were sold to campers and vacationists, who seemed more than ever to realize the entertaining qualities these wonderful little instruments possess. 'Just the thing,' one young lady said, 'to have our dancing out on the lawn.'

"Instrumental records proved the best sellers this month, with jazz bands and dance records leading.

"'Service' seems to be the one great aim of all the enterprising Victrola dealers, and they are spending large sums of money for fixtures, booths, sign displays and many other attractive articles, in order that they may get their stores to look attractive and also for the convenience of their customers."

C. L. Byars reports the biggest Vocalion business the local Aeolian store has ever experienced in the month of June. He is still suffering a shortage of goods, but Mr. Byars feels confident that if some stock comes in to relieve the situation in July and August these two months will be record breakers.

Miss Hortense Palmer, one of the charming members of the Vocalion Record staff, has just embarked on the long journey on the sea of matrimony. Miss Palmer leaves with the congratulations and best wishes of all her associates.

One of the newest organizations to take on the jobbing of Emerson records is the Southern Sonora Co., Selma, Ala., which has been given the territory covering all of Georgia and Florida.

For Edison, Victor and Columbia Dealers Only

WE HAVE THE

SIMPLICITY ELECTRIC MOTOR

(AUTOMATIC SWITCH IN MOTOR)

Makes winding unnecessary. Electrifies your Edison, Victor or Columbia efficiently and satisfactorily. The **Finest Electric Motor** on the market.

FOR ALL OTHER DEALERS

For dealers handling any make of phonograph other than the Edison, Victor, Columbia we have perfected a new

WINDING DEVICE

that is automatic, "self-operating." Best ever offered to the trade. It is attachable to any make of phonograph other than the three mentioned above and electrifies any phonograph instantly. Requires no adjustment.

Shelton Electric Co.

16 East 42d Street, New York · 30 East Randolph Street, Chicago

STRADIVARA

"KNOWN FOR TONE"

YOUR FALL TRADE WILL DEMAND THE STRADIVARA. SIX BEAUTIFUL MODELS, POPULARLY PRICED WITH UNUSUAL TONE QUALITY AND EXQUISITE WORKMANSHIP. SOME DESIRABLE TERRITORY STILL AVAILABLE IF YOU APPLY QUICKLY. FULL ADVERTISING SERVICE, OF COURSE.

Manufactured by THE COMPTON-PRICE CO., COSHOCTON, O.



THE SUBTLE 
BEAUTIES OF ALL
RECORDS ARE BROUGHT TO LIFE
ONLY WHEN PLAYED ON THE
 STRADIVARA

W. C. FUHRI JOINS HEINEMAN STAFF

Well-known Talking Machine Man Appointed General Manager of Record Division of Otto Heineman Supply Co., Inc.—A Man of Wide Experience in All Branches of the Industry

The Otto Heineman Phonograph Supply Co., Inc., announced this week, through John Cromelin, general sales manager, the appointment of W. C. Fuhri as general sales manager of the record division, with headquarters at the company's executive offices, 25 West Forty-fifth street, New York. Mr. Fuhri will also devote his time to co-operating with and giving serv-



W. C. Fuhri

ice to the users of all other Heineman products, including Heineman motors, tone arms, sound boxes, needles, etc.

W. C. Fuhri is one of the best-known members of the talking machine industry in the country. For the past twenty-one years he has been associated with the Columbia Graphophone Co., having occupied important executive positions with that company.

In 1898 he joined the Columbia forces at St. Louis, in a short time becoming assistant man-

ager of that branch. After six months he was promoted to manager and two years later was district manager, with headquarters in St. Louis, his territory comprising the entire Southwest.

In 1906 Mr. Fuhri was transferred to Chicago, where he was given control of the entire district from New Orleans as far west as Salt Lake City. He occupied this post for ten years.

In 1916 Mr. Fuhri went to New York to become United States manager for the company, having under his jurisdiction the entire business throughout the United States. A change of policy influenced him later to request that he be reassigned to his former post in Chicago, where he has been for the past year.

Mr. Fuhri's past experience admirably equips him to render invaluable co-operation and service to the Heineman clientele. He brings to his new position a thorough knowledge of the phonograph industry and an intimate familiarity with all details of record and phonograph merchandising that is equaled by very few members of the trade. Mr. Fuhri will take a much-needed rest and assume his new duties within the near future.

ATLANTA TRADE CONTINUES STRONG

Summer Months Show No Lessening of Business—Leading Houses Report Continued Activity—Columbia Salesmen and Dealers Meet

ATLANTA, GA., July 7.—Reports from several hundred talking machine dealers in this State indicate that business is running in higher figures than ever, and the summer months are bringing no noticeable slowing up. Trade conditions are entirely satisfactory, largely due to the fact that cotton has advanced in price and a great deal of money is in circulation.

Manager Terhune, of the local branch of the Columbia Graphophone Co., recently made a trip to Florida and returned very much pleased with conditions as he found them.

A feature of the month was the meeting of Columbia traveling salesmen and dealers held at the Ansley Hotel early in June. After an excellent dinner the new records were played and short talks were given by various dealers.

Active summer business is reported by the Zaban Furniture Co., Columbia dealers; the Atlanta Talking Machine Co., the Cable Piano Co., Victor dealers; the Delpheon Shop, Chamberlin-Johnson-DuBose Co., Victor and Sonora dealers; the Phillips & Crew Piano Co., Phonographs, Inc., Edison jobbers, and the Elyea Co.

Prepare!

DURING the past year or more dealers have sold many excellent records for which there had been little demand.

THE extreme shortage which resulted in the dealer's inability to supply sufficient of the records asked for, forced him to familiarize himself with the class of records he could procure and to interest his customers in them.

THE demand for records will continue to grow and even with increased output there will be a shortage of many numbers.

ANTICIPATE this demand and see that you have a stock of those so-called slow selling records and do not lose profits other dealers are making.

SALESMEN ARE CRANKS ON TONE

They have tried every needle on the market—but now they are perfectly happy with the perfect needle.

THE DE LUXE STYLUS

It plays 100 to 300 Records

Three for 30 Cents

They are enthusiastic about it because it does not scratch or hiss.

It brings out the perfect tone.

Used once always enjoyed.

You can't afford to be without The DE LUXE

The Duo-Tone Co.

Manufacturers of Talking Machine Needles

ANSONIA, CONN.

C. BRUNO & SON

INCORPORATED

Victor Distributors to the Dealer Only

351-353 Fourth Avenue

NEW YORK

WE DO NOT RETAIL

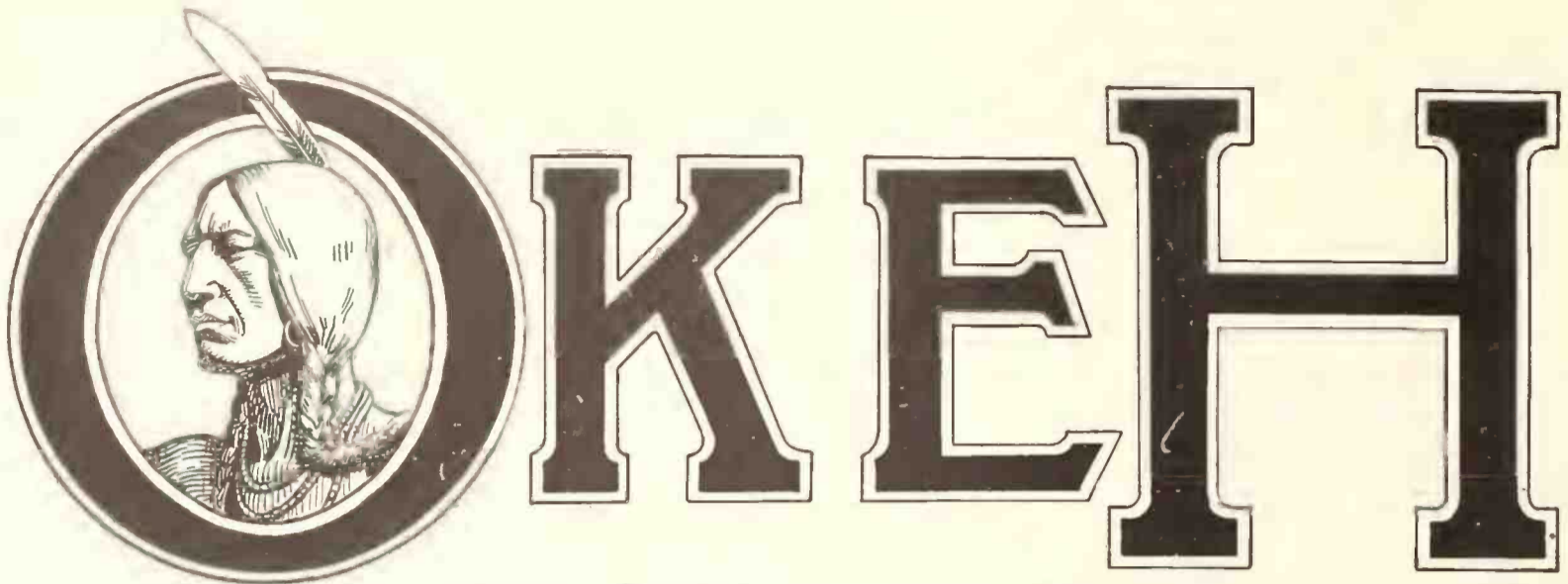

RECORDS

**WELCOME
COMPARISON**

This record is not only the most popular record line on the market because dealers are receiving IMMEDIATE DELIVERIES of the best-sellers of the day, but because it is a QUALITY PRODUCT.

OkeH Dealers can therefore furnish the popular hits of the day IMMEDIATELY, and they can also merchandise the OkeH Record strictly on its musical merits, and tonal superiority.

ISN'T THIS A WINNING COMBINATION?

We can tell you more about our dealer plan

RISHELL PHONOGRAPH COMPANY

OkeH Jobbers

WILLIAMSPORT, PA.

UNITED PHONO. CORP. ENTERTAINS

Dealers From All Parts of Country Visit Puritan Phonograph Plant—Show Visitors How Machines and Records Are Made

SHEBOYGAN, WIS., July 2.—During Friday and Saturday of last week the United Phonograph Corp., makers of the Puritan phonograph, entertained dealers from all parts of the country who came to inspect the Puritan plant. The visitors divided their time between the factories at Grafton, Port Washington and this city. At Grafton they had the opportunity of seeing records made. At the banquet on Friday night a pleasing program was offered by the artists on the Puritan staff and the officials of the company outlined the plans by which the present success of the concern has been attained. Col. E. J. Barrett presided as toastmaster and gave the credit for the success of the Puritan to the splendid co-operation shown by the dealers.

Among those present at the banquet were: R. W. Micks, Gladstone, Mich.; L. J. Lively,

Morrison, Ill.; Joe Frank, Bristol, Tenn.; O. C. Horn, Oshkosh; C. E. Whitcomb, Minneapolis, Minn.; Arthur T. Garrett, St. Paul; Robert J. Karsten, Milwaukee; Raymond A. Kuhn, Milwaukee; C. B. Allen, Madisonville, Kentucky; I. Zimmermann, Duluth, Minn.; Elmer J. Joostou, Peoria, Ill.; A. J. McCampbell, Bessemer, Ala.; Dick Kimm, Rockford, Mich.; Joseph P. Malloy, B. Brown, Charles J. Orth, Milwaukee; L. M. Beck, Fort Wayne, Ind.; Col. E. J. Barrett, Gordon Osborn, L. T. Jenkins, R. L. Meves, Sheboygan, and O. E. Moeser, Port Washington.

CHATTANOOGA TRADE STILL ACTIVE

Conditions for June Satisfactory—Sterchi Bros. Change Name—Trade in Rural Districts Unusually Active—Other News of Interest

CHATTANOOGA, TENN., July 7.—Business conditions in the talking machine trade in this city for June were very satisfactory. The volume of sales continued to be unusually large, and most dealers received shipments of stock with greater

regularity than for some time past. The record business especially is very active, many of the manufacturers being oversold for months ahead on the standard pieces.

The Sterchi Bros. Furniture Co., Columbia and Edison dealers, announce a change in firm name to Sterchi Bros. & Fowler. Mr. Fowler has for several years been an officer and stockholder in the firm, and his addition to the staff of this concern is a recognition of his work in the music trade in the South. This firm has for some weeks past been using much space in the local newspapers, and excellent results have been obtained from this form of advertising.

Other enterprising music houses that are sharing in the general trade here are the Stulce-Yarnell Furniture Co., Columbia dealers; Rhodes-Mahoney Co., Victor and Brunswick dealers; Clemons Bros., Victor and Sonora dealers; and the Templeton Piano Co., which has increased its talking machine department considerably within the last year. Reports from travelers in the surrounding territory indicate that business is very good in the rural district.

The Machine that Plays any Record



PHONOGRAPHS and RECORDS

The Machine that Plays any Record

Empire records are becoming more popular every day and dealers are finding large sales for them. One of our dealers writes as follows:

“Received the 50 records No. 31104 this morning and sold them all before 5.00 P. M. Wish I had ordered more.”

We know that you can also sell a great number of Empire records to your patrons. Write for our August record catalog or send us an order for a dozen samples. Liberal discounts to dealers. See list of August records in record bulletin of this paper.

EMPIRE UNIVERSAL CUT

Records can be played on any phonograph using a steel needle



See List of August Records in the Record Bulletin of this Paper



Model XA Mahogany or Walnut



Model B Mahogany Walnut or Oak

EMPIRE UNIVERSAL CUT

Records can be played on any phonograph using a steel needle



No Attachment Needed No Sound Box to turn

WRITE FOR OUR CATALOG AND AGENCY PROPOSITION

Empire talking machines are unexcelled in quality and are all equipped with high grade motors. There are ten models in the line—prices at retail are from \$35.00 to \$500.00.

EMPIRE TALKING MACHINE CO.

John H. Steinmetz, President
429 South Wabash Avenue, Chicago, Ill.

THE SATURDAY EVENING POST

VITANOLA

Plays All Records — Natural As Life

ALTHOUGH our nation-wide publicity campaign has just been inaugurated, already the VITANOLA has taken its rightful place among the world's largest sellers.

Not only is the VITANOLA—*The Phonograph of Marvelous Tone*—now being brought, through extensive National publicity, to the attention of millions of buyers, but our service to dealers has been broadened accordingly, and we invite you to learn more about this by sending for a copy of the pamphlet entitled "Making a Phonograph Department Pay."

This pamphlet will be interesting and instructive to you, whether or not you handle the VITANOLA, as it is based entirely upon actual experiences of successful dealers.

Write for your copy today.

Vitanola Talking Machine Co.

508 West 35th St., Chicago, Ill.

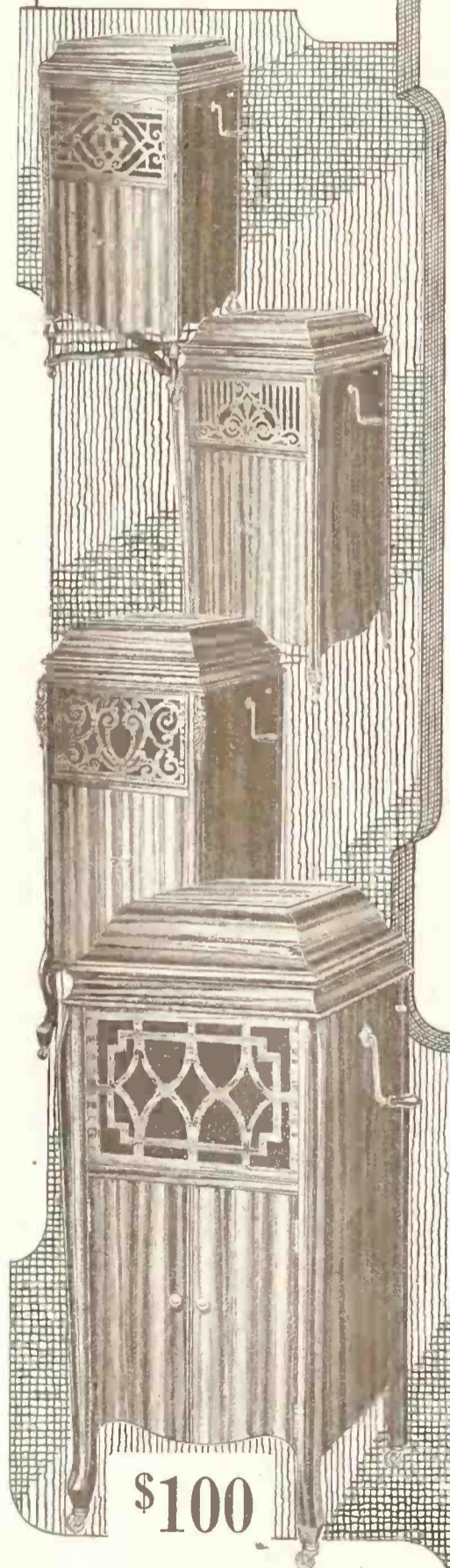

CONVENTION OF HEINEMAN EXECUTIVE AND SALES STAFF

Encouraging Reports Made at Two-day Gathering of Heineman Forces—President Otto Heineman Gives Valuable Data—Garford and Meisselbach Enterprises Steadily Progressing

Otto Heineman, president of the Otto Heineman Phonograph Supply Co., Inc., 25 West 45th street, New York, was the host at a luncheon given at the Hotel Astor recently in conjunction with a convention of his executive and sales staff. The meeting lasted two days and many important topics were discussed and plans consummated which will greatly enhance the co-operation and service offered to the Heineman clientele.



Otto Heineman

At the luncheon Mr. Heineman gave his staff some valuable data in connection with the remarkable progress of the various Heineman factories during the past six months. Figures were advanced showing that the output of Heineman motors has increased tremendously within the past year, and after submitting these figures Mr. Heineman paid a well-deserved tribute to the untiring efforts and indefatigable work of A. G. Bean, president of the Garford Manufacturing Co. (now a part of the Heineman organization), who has been in charge of the Elyria plant since the inception of the Otto Heineman Phonograph Supply Co., Inc.

Record of A. G. Bean

Mr. Bean, who was recently elected president of the Garford Mfg. Co., after being its vice-president and general manager for many years, is one of the best-known manufacturers in the Middle West. He has been an important factor in manufacturing circles throughout this section of the country for a number of years and at the present time is president of the Manufacturers' Association of Elyria. He has worked day and night to bring the Elyria factory to its present state of high efficiency and the phenomenal success attained by the Heineman motor may be attributed in a considerable measure to Mr. Bean's rare executive acumen, remarkable manufacturing knowledge and thorough familiarity with every phase of motor production. He has left nothing undone to make the Elyria plant a model factory in every sense of the word and visitors to this plant are amazed at its magnitude and scope.

Some time ago Mr. Heineman made a trip through the Middle West, spending several days at the Elyria factory, and after a conference with Mr. Bean arrangements were made providing for the enlargement of the plant in practically every department and contracts were awarded for new machinery. This machinery is now installed and its beneficial effect on Heineman motor production is indicated in the fact that the output during June far exceeded any month in the history of the company. Mr. Bean submitted preliminary estimates showing that July and August will even outdistance the June figures and the executive and sales organization was delighted to receive this gratifying news.

Encouraging Meisselbach Reports

A. F. Meisselbach, vice-president of the Otto Heineman Phonograph Supply Co., Inc., gave equally encouraging reports of the situation at Newark and in one of his usual witty speeches expressed his sincere appreciation of the co-operation that has been given the Meisselbach

division by every member of the Heineman organization. The new \$500,000 Meisselbach factory at Newark is making rapid headway, and when this plant is completed ample facilities will be afforded for the development and growth of the Meisselbach division. For several years past the demand for Meisselbach motors has been far in excess of the available factory output, but the new building will solve this problem satisfactorily and give Mr. Meisselbach and his associates an opportunity to vastly increase their output.

OkeH Records Going Well

John Cromelin, general sales manager of the company, furnished interesting data regarding the progress being made with the OkeH record. The sales organization was pleased to learn that the new lists of OkeH records have won enthusiastic commendation from well-known musical critics who have visited the OkeH record laboratories during the past few months and Mr. Cromelin advised the sales staff that manu-

facturing conditions will enable the record division to give immediate deliveries and prompt service to OkeH jobbers and dealers everywhere.

Brief addresses were also made by several other members of the executive staff, and among others who attended the luncheon in addition to those mentioned above were the following: Adolf Heineman, vice-president; Jacob Schechter, secretary; W. G. Pilgrim, assistant general manager; Pliny Catucci, chief engineer; A. L. Patrick, treasurer of the Garford Mfg. Co.; S. A. Ribolla, general manager of the Chicago branch; John Dean, of the Dean Division; C. J. Pott, Canadian manager; Anthony Vesseli, superintendent of the Newark factory; P. L. Baerwald and M. E. Schechter, managers of the Eastern sales division; W. C. Strong, of the Newark division; R. C. Ackerman, export manager, and L. M. Robinson, advertising manager.



A. G. Bean

TO ADDRESS TALKING MACHINE MEN

Geo. W. Pound to Speak Before Local Organization at Luncheon on July 16—To Launch a Strong Membership Campaign

George W. Pound, general counsel of the Music Industries Chamber of Commerce, will address the members of the Talking Machine Men, Inc., at a special luncheon of that organization at the Hotel McAlpin on Wednesday, July 16. It is stated that Mr. Pound will have an important message to deliver to the talking machine men who, by virtue of their recently acquired membership in the National Association of Music Merchants, have become affiliated with the Music Industries Chamber of Commerce.

At the meeting on July 16 the Talking Machine Men, Inc., will launch their strong membership campaign, which will last the month, and will wind up at the annual outing of the organization at Rye Beach on August 13.

CANADIAN COPYRIGHT ACT DROPPED

OTTAWA, ONT., July 1.—The special committee of the Canadian Senate on the proposed new Copyright Act has submitted its report to that body. It is understood that the bill will be dropped by the Government with the idea of introducing it again next session. In the meantime negotiations will be entered into with the United States in an effort to reach an agreement regarding a mutually satisfactory basis of copyright between the two countries.

THE COPPER PROCESS CO.
OF NEW YORK

WISHES to announce to the manufacturers of Talking Machines that they are now in a position to produce according to the demands and specifications of the manufacturer, copper tone arms of unbreakable structure. Tone Arms of less parts, of more graceful lines and of better tonal qualities, are the products of our company.

We are also makers of Tone Arms of our own designs. We recommend that you acquaint yourself with our "Universal No. 2."

THE COPPER PROCESS CO.
19-21 WEST 44th STREET, NEW YORK

NICHOLSON
Talking Machine
RECORD CABINETS
the kind that talk
VALUES and SALES
K. NICHOLSON FURNITURE CO., Chase City Virginia
Record Cabinets, Sect. Bookcases and Ladies' Desks

SLIGHT SLUMP IN TOLEDO TRADE

Local Conditions Have Temporary Effect on Talking Machine Business—Stocks Still Slack—What Various Concerns Report

TOLEDO, OHIO, July 7.—Most of the local dealers seen by your correspondent report business not quite up to normal. This, however, is due entirely to the conditions here in Toledo.

The various Pathé, Columbia and Brunswick dealers report business fair. The Edison representative is having a fairly good sale on the higher priced models. Until local conditions improve business in the talking machine field will not show marked activity.

The Cable Piano Co. reports the demand for Victrolas in excess of its shipments, with a slight falling off in the demand for records.

The Whitney & Currier Co. are experiencing difficulty in getting a sufficient quantity of Victrolas and records to take care of their trade.

The J. W. Greene Co. reports business fairly good in all lines.

Chas. H. Womeldorff, manager, and Warren

L. Kellogg, assistant manager of the Toledo Talking Machine Co., have just returned from the jobbers' convention at Atlantic City, and report being very well satisfied with conditions at the factory. In their estimation the Victor Co. is doing all that is possible to speed up production. They were very favorably impressed with the new period designs just shown by the Victor Co., and believe that these machines will meet with a ready sale to the dealers and to the trade in general. All things taken into consideration, the past convention was the most successful of those held by the National Association.

The demand for Victor goods from the out-of-town dealers still continues unprecedented, and prospects are for an immense business this fall and winter.

INCORPORATED

The National Phonograph Co. of Pittsburgh has been incorporated under the laws of Pennsylvania with a capital stock of \$50,000 by H. H. Fleischman and others.

Specialized Manufacturing Production for the Phonograph Trade



"They buy at a place where prices compete, where Quality must always excel." Only one of the reasons our business is growing. "We serve all our customers well."

NEEDLE CUPS, BRAKES, COVER SUPPORTS, REGULATOR DIALS, etc.

What Is Your Need?

Correspondence invited—Orders promptly attended to
60 Grand Street New York City

CONVENTION OF EDUCATIONAL FORCE

Staff of Victor Co., Educational Department, With Heads of Departments Conducted by Jobbers and Dealers, to Convene in Camden

During the last week in August there will be held at the Victor Co. headquarters in Camden a general convention of the staff of the Educational Department of that company, under the direction of Mrs. Frances G. Clark, which convention will also be attended by the heads of the various educational departments conducted by wholesalers and dealers. During the course of the convention there will be held a number of interesting and helpful lectures by musical authorities as well as a series of descriptive concerts. The growing interest shown in educational work by the Victor wholesalers and dealers at large and the establishment of special departments by many of them to handle that phase of the business should serve to lend much interest to the forthcoming convention. Before the August meeting Mrs. Clark plans to spend a vacation of several weeks in Maine in order to recuperate after a distinctly strenuous season.

ANNA CASE ENTERTAINS WOUNDED

Soldiers From New York Hospital Guests of Edison Artist at Home Near Mamaroneck

An admirable climax to the notable war work accomplished by Miss Anna Case, the Edison artist, was a lawn party and concert given by her at her summer home near Mamaroneck on Flag Day to 200 wounded soldiers from a New York hospital. The feature of the entertainment was a short concert by Miss Case, assisted by some vaudeville acts from New York theatres. The entertainment was given on a side porch overlooking the wide lawn and Long Island Sound, the porch being draped attractively in the national colors. The soldiers and their nurses were grouped about the lawn, many of the former being in such shape that they had to be carried from the army ambulances on cots.

Miss Case sang a new song which she has just composed: "The Robin's Song," and her singing served to inspire the wounded soldiers immensely. "You don't know how much you've done for us, Miss Case," said one. "This is the happiest day I've ever known." After the entertainment supper was served on the lawn, and the guests returned to the hospital.

S. S. Hackett and his wife and daughter, all from Fresno, Cal., spent a few days recently in New York City. Mr. Hackett is of the Bristol-Cowan Co., large Columbia dealers.

STIMULATE SUMMER SALES

The GARFORD Model C Phonograph is designed to assist you in developing a profitable summer business. Its appeal to vacationists is only one of its many sales possibilities.

THE GARFORD MODEL C

Retails at \$15

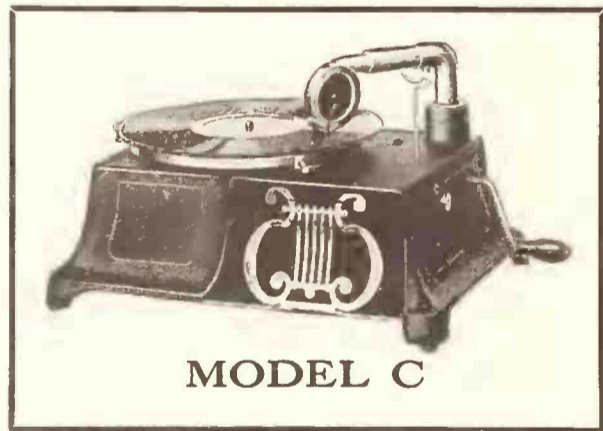

Retails at \$15

The GARFORD Model C is a high-class phonograph constructed of quality materials and *guaranteed* to give absolute satisfaction and excellent service.

Our Dealer Proposition is Unusually Attractive

THE GARFORD MFG. CO.
ELYRIA, OHIO

COTTON FLOCKS

.. FOR ..
Record Manufacturing
THE PECKHAM MFG. CO., 238 South Street
NEWARK, N. J.

HOME OF **DOEHLER** PRODUCTS

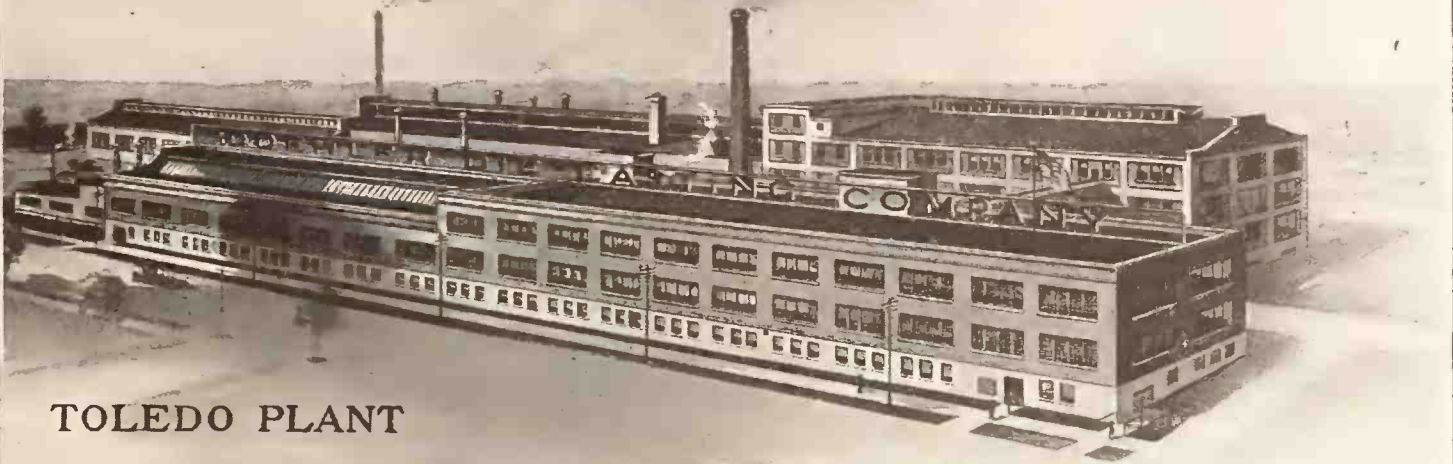

TOLEDO PLANT



BROOKLYN PLANT

DOEHLER DIE-CASTING CO.

MAIN OFFICE AND EASTERN PLANT
BROOKLYN, N.Y.

WESTERN PLANT
TOLEDO, OHIO.

SALES OFFICES IN ALL PRINCIPAL CITIES

HANDSOME WINDOW POSTER

Sonora Phonograph Sales Co. Sends Out a Number of Sales Aids in Form of Posters Bearing Particularly on the Sonora Portable

The Sonora Phonograph Sales Co., Inc., is sending to its dealers at this time some extraordinarily handsome window display posters, two of which are unusually apropos of this season, inasmuch as they feature the Portable. One of



Sonora Window Poster Much Admired

these posters pictures a Sonora Portable in connection with a wonderfully inviting vacation scene, composed of pretty girls, snow-capped mountains, and beautiful vistas. Another illustrates the Sonora Portable entertaining a party of smart automobilists while resting leisurely on the roadside, an illustration of which appears herewith.

Both of these attractive posters prove to be extremely powerful arguments to demonstrate that the Sonora Portable is just the kind of musical instrument to be taken with one on a vacation.

Among other artistic lithographs which the Sonora Co. is sending out is one showing the Baby Grand in a fashionable shore home. All of these display posters are excellent in coloring and composition and undoubtedly constitute a set of the sales aids that will be appreciated by dealers.

What More Can You Ask

All the features that go to make a talking machine *Profitably Salable* you will find as regular equipment of *Magnola*: "Built by Tone Specialists."



Complete description of all these features is to be found in our *handsome illustrated catalog*, which we should like to send you. May we? Ask us to tell you our plans for your benefit!

MAGNOLA TALKING MACHINE COMPANY

OTTO SCHULZ, President
 General Offices: 711 MILWAUKEE AVENUE, CHICAGO
 Southern Wholesale Branch: 1530 CANDLER BLDG., ATLANTA, GA.

**A
 RECORD CABINET
 MATCHING
 VICTROLA NINE A**



309 1/2.—Mahogany, golden oak, fumed oak, weathered oak, nickel plated trimmings, lock and key, shelves interior, casters. Height, 33 inches. Top, 18 1/4 x 21 1/8 inches. Matches New Victrola IX A. Patented rimmed moulding with removable back piece, so machine can easily slide in, giving a perfect "Cabinet-match" appearance. Average weight, crated, 70 pounds.

MANUFACTURED BY

SCHLOSS BROS.

637-645 West 55th Street New York

Cabinets of all descriptions and finishes

Catalogue No. 20 Ready for Distribution.

Have You One?

E. J. WALZ WITH COHEN & HUGHES

Well-Known Member of Victor Co. Staff to Become General Manager for Cohen & Hughes, Prominent Wholesalers of Baltimore.

BALTIMORE, Md., July 2.—Cohen & Hughes, prominent Victor wholesalers of this city, have just made the important announcement that Elmer J. Walz, who for the past fifteen years has been connected with the Victor Co. in various capacities, will become associated with the Cohen & Hughes organization as general manager on August 1.

In making the announcement Cohen & Hughes say: "Realizing that the reconstruction period is bringing bigger possibilities and broader responsibilities, we have found it necessary to augment our organization in order to give our dealers the full measure of support and co-operation to which they are entitled."

The wide experience of Mr. Walz in the Victor business eminently fits him for his new responsibilities, and it is expected that his association

with the house of Cohen & Hughes will prove a distinct factor in the development of that company's business.

NEW DEALERS IN BELL HOOD NEEDLES

The New England Musical Instrument Trading Co., New York, distributors for the Bell Hood semi-permanent needle, have added many dealers to the list of those acting as agents for their product. The needle is meeting with success and from a consumer's standpoint is gaining much popularity. Philip Jacobson, head of the above company, is making a campaign to enlist the support of the dealers in the eastern territory which will be immediately followed by a drive in the Middle West.

Write for our catalogues on phonograph hardware, motors, tone arms, records and accessories.

HIGHEST QUALITY LOWEST PRICES
COLE & DUNAS MUSIC CO.
 54 W. LAKE STREET CHICAGO

The WATSON SISTERS (Fannie and Kitty)

Celebrated Stars of the Winter Garden Show "Monte Cristo Jr."

Record Four Song Hits *Exclusively* for

OKEH RECORDS

IMMEDIATE DELIVERIES of the WATSON SISTERS OkeH Records, and all the other *popular hits* listed below, comprising our

ORDER NOW

SEVENTH BULLETIN

ORDER NOW

- | | | | |
|------|---|------|---|
| 1193 | WHO PLAYED POKER WITH POCAHONTAS? (Fannie Watson, of Watson Sisters) | 1199 | CHONG (Fox Trot) |
| | FOR JOHNNY AND ME (Kitty Watson, of Watson Sisters) | | SINGAPORE (Fox Trot) |
| 1194 | WHEN YOU SEE ANOTHER SWEETIE HANGING AROUND (Kitty Watson, of Watson Sisters) | 1200 | AFTER ALL (Fox Trot) |
| | EVERYBODY WANTS A KEY TO MY CELLAR (Fannie Watson, of Watson Sisters) | | (DRY YOUR) TEARS (Fox Trot) |
| 1195 | THE RED LANTERN (Baritone) | 1201 | YOU'RE STILL AN OLD SWEETHEART OF MINE (Vocal Duet) |
| | I'M FOREVER BLOWING BUBBLES (Tenor) | | WHEN YOU LOOK IN THE HEART OF A ROSE (Tenor) |
| 1196 | SWEET SIAMESE (Fox Trot) | 1202 | WAIT AND SEE (Tenor) |
| | RUSPANA (One Step) | | HEART BREAKING BABY DOLL (Tenor) |
| 1197 | MAMMY O'MINE (Vocal Trio) | 1203 | THAT LONG, LONG TRAIL IS GETTING SHORTER NOW (Vocal Trio) |
| | I FOUND YOU (Tenor) | | SALVATION LASSIE OF MINE (Tenor) |
| 1198 | BEAUTIFUL OHIO (Vocal Duet) | 1205 | TURKESTAN (Vocal Quartet) |
| | TEARS (OF LOVE) (Tenor) | | BURMAH MOON (Tenor) |
| | | 1206 | EYES THAT SAY "I LOVE YOU" (Tenor) |
| | | | CHONG (Tenor) |



Otto Heineman Phonograph Supply Co.

INCORPORATED

25 West 45th Street

New York City, N. Y.

FACTORIES: Elyria, Ohio Newark, N. J.
Putnam, Conn. Springfield, Mass.



BRANCH OFFICES: Chicago, Ill. San Francisco, Cal. Toronto, Ont.

EXHIBITS OF TALKING MACHINES AT GRAND RAPIDS SHOW

Interesting Feature of Semi-Annual Furniture Show Just Opened in Grand Rapids Is the Extensive Display of Talking Machines Made by Various Well-known Firms

GRAND RAPIDS, MICH., July 1.—Grand Rapids is not only the headquarters market for all high-grade furniture, but it is rapidly becoming one of the leading markets in this country for the talking machine business, at least so far as semi-annual displays are concerned.

The exhibits in this market this summer of talking machines are attracting very pronounced attention, and the company that will admit doing a poor business has not yet been found. Indeed, one concern which does a very fair volume of business is known to have sold its season's output in the first two days of the market. That was unfortunate, it is felt, for obviously that concern sold to jobbers who were anxious to pick up all the stock they could get early. This is the only company in this market which has consented to sell in job lots. The others have talked this way: "We don't care if we don't sell our entire output. We do insist on our goods getting a wide distribution—that's the best sort of business in the end."

As was to be expected, among the most attractive exhibits in the market are those of the Cheney Talking Machine Co., the Michigan Phonograph Co. (Lauzon), the Widdicomb Co., and the Grand Rapids Phonograph Co. All of these concerns are essentially Grand Rapids products, very few parts used by any of them being made outside of this city. The Cheney is showing a large line in the Keeler exhibition building, its cabinet work, done by the Berkey & Gay Furniture Co., being fully as elegant as the cabinet work on any of that concern's highest-grade furniture. Walnut and mahogany in various finishes are used. Obviously one sees in these machines the acme of exemplification of the leading period styles, and buyers of high-grade furniture are proving insistent on being given fully as much elegance in cabinets as is found in the best period furniture.

The new Grand Rapids Phonograph Co., formerly the Grand Rapids School Equipment Co., is showing a number of models of its L'Artiste, in mahogany, walnut and oak. The company is using the Meisselbach motor and its own tone arm, and is producing a beautiful machine. The finished product will be on the market during the last week in August. Meanwhile a good business is being done, and jobbing will be maintained only in the far southern and southwestern parts of the country.

The Michigan Phonograph Co., which is a branch of the Lauzon Furniture Co., is making as its leader this season a large model in Japanese lacquer finish. The Lauzon is a most artistic model, with a finish that is easily accounted for by the fact that the same artists who have been making the famous Lauzon lamps for some years are now working on the finish of the cabinets. Two oaks, two mahoganies and a walnut are being shown in a variety of periods. The Krasberg Motor Co. had an exhibit in the same building.

The Widdicomb Furniture Co. in its phono-

graph department is showing twenty pieces in ten models in mahogany, walnut and oak, the prevalent period styles, and the same excellent quality of goods. The company did not bring out any new models for this exhibition, business in both furniture and talking machine lines being too great.

The Starr Piano Co., Richmond, Ind., as usual made an exhibit in the Furniture Temple, where it has been for six semi-annual seasons. Half a dozen high-grade machines were shown, and a good business was booked.

Exhibits of less pretentious character are being made by the new Crescent Co., the American Phonograph Co., the Arcraft Phonograph Co., all of Grand Rapids; Naturvia, made by the Natural Way Phonograph Co., in Zeeland, Mich., the Supertone, of New York; the Manophone Corporation, of Adrian, Mich., shown in the Morton House lobby, the first time in connection with a furniture exhibition; the Empire of Chicago, the Concertola, of New York, West Michigan Furniture Co. and other exhibits.

One of the centers of interest was the OkeH building, the entire ground floor of which had been turned over for exhibition purposes. Among the products shown in this building are: Heineman-Meisselbach motors and phonograph supplies, Dean needles, OkeH records, made by the Otto Heineman Phonograph Supply Co., New York; Peerless record albums, Peerless Album Co., New York; B & H Fibre Needles, B & H Fibre Mfg. Co., Chicago; Fletcher-Wickes sound-boxes and tone-arms, Fletcher-Wickes Co., Chicago; Modernola talking machines, the Modernola Co., Johnstown, Pa.; Supertone talking machines, Magnedo needles and Triangle phono-parts, L'Artiste talking machines, the Elite phonographs, Elite Phonograph Co., Grand Rapids; Veeco electric motors, the Veeco Co., Boston, Mass., makers of Veeco electric motors.

In the Klingman Annex, where several of the smaller phonograph concerns are showing their exhibits in small booths, there is a large exhibit of talking machine accessories—motors, tone arms, modifiers, automatic stops, turntables, needles, gear winds, record albums, etc., in an interesting profusion.

Considering that this is the first ambitious effort ever made to stage an exhibit of phonographs in Grand Rapids, the results are fine. The buyers have also seen on exhibition cabinets made by ten to twelve furniture manufacturing companies on contracts for such concerns as Pathé, Columbia, Aeolian-Vocalion, Sonora, and others. It is said on good authority that phonographs and cabinets being made on contract in this city will aggregate twelve million dollars in value.

During the year 1918 the musical instruments exported by France to the United States amounted to \$401,300. This was a decided decrease from the exports in 1917, which were valued at \$981,000.



AUTOMATIC STOPS

The simplest and most efficient Automatic Stop on the market. They give excellent service, are easily installed and are absolutely guaranteed.

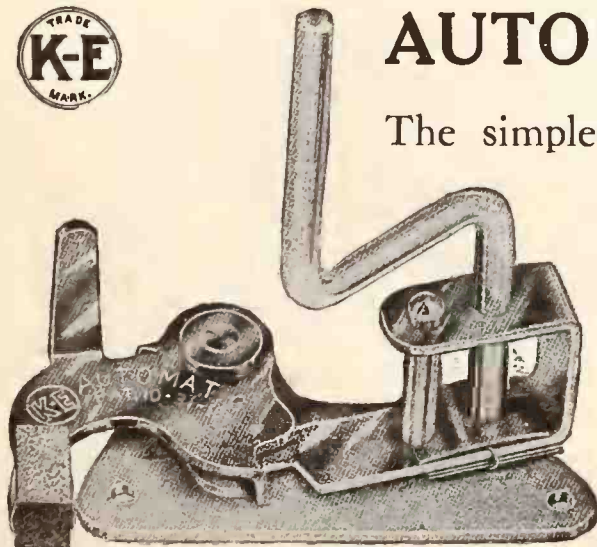

Send 50 cents for Sample Stop

Kirkman Engineering Corporation
237 Lafayette St., New York

VAN VEEN

"Bed Set" Booths
Sectional Record Racks
Record Sales Counters

How We Serve the Dealer

☞ We give individual service to the dealer and prefer to lay out a plan that will meet his exact conditions rather than make his business fit our plans. We study the dealer's needs and requirements, bearing in mind that local conditions and surroundings may not always conform to fixed plans and specifications. *Individual Service* has been the key-note of our success.

☞ Send us a plan of your store showing doors, windows, and the position of other fixtures. Our service department will then lay out the installation best fitted for your store.

Van Veen Booths, Record Racks and Counters Ready for Prompt Shipment

Why Van Veen Booths Are Better

- No. 1. Built of best kiln-dried lumber.
- No. 2. Correctly constructed by skilled craftsmen.
- No. 3. Embody Economy, Simplicity and Efficiency.
- No. 4. Each section is complete in itself, eliminating faulty fitting of numerous small parts that dry out and cause open joints and sound leakage.
- No. 5. High grade glass in large sizes of extra thickness and clearness is a feature, no booths built with less than two-thirds length glass.
- No. 6. Moderate in price and most economical in comparison with any other booths manufactured.
- No. 7. Easily erected, no complicated attachments requiring adjustment.
- No. 8. Handsome in design and high grade cabinet finish.

Write, wire or phone for our representative

Arthur L. Van Veen & Co.
Marbridge Bldg.
47 West 34th St., New York
Tel. Greeley 4749

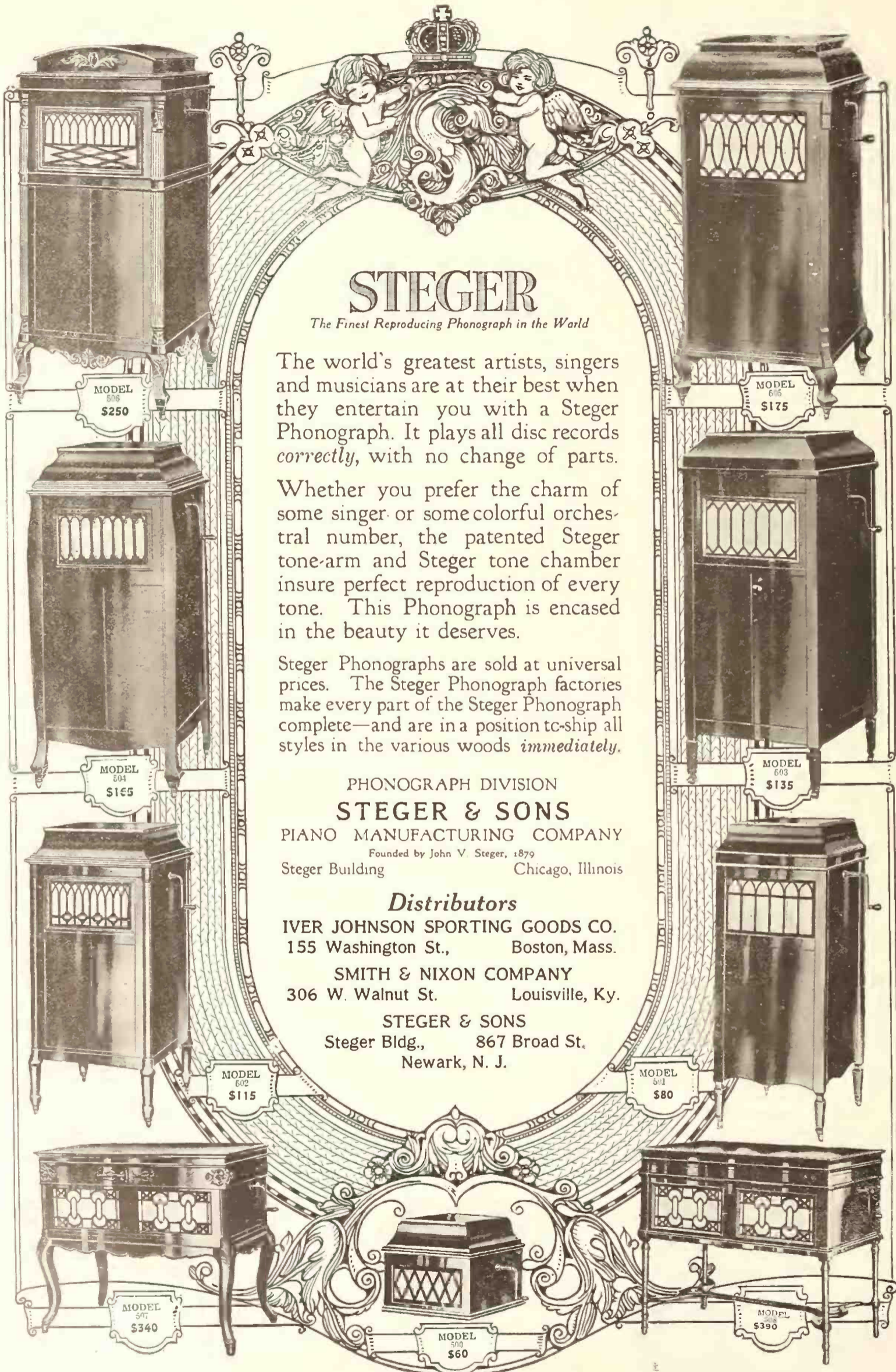

STEGER

The Finest Reproducing Phonograph in the World

The world's greatest artists, singers and musicians are at their best when they entertain you with a Steger Phonograph. It plays all disc records *correctly*, with no change of parts.

Whether you prefer the charm of some singer or some colorful orchestral number, the patented Steger tone-arm and Steger tone chamber insure perfect reproduction of every tone. This Phonograph is encased in the beauty it deserves.

Steger Phonographs are sold at universal prices. The Steger Phonograph factories make every part of the Steger Phonograph complete—and are in a position to ship all styles in the various woods *immediately*.

PHONOGRAPH DIVISION

STEGER & SONS

PIANO MANUFACTURING COMPANY

Founded by John V. Steger, 1879

Steger Building Chicago, Illinois

Distributors

IVER JOHNSON SPORTING GOODS CO.
155 Washington St., Boston, Mass.

SMITH & NIXON COMPANY
306 W. Walnut St. Louisville, Ky.

STEGER & SONS

Steger Bldg., 867 Broad St.
Newark, N. J.

MODEL 606
\$250

MODEL 605
\$175

MODEL 504
\$165

MODEL 503
\$135

MODEL 602
\$115

MODEL 501
\$80

MODEL 507
\$340

MODEL 500
\$60

MODEL 500
\$390

FROM OUR CHICAGO HEADQUARTERS

Edward Van Harlingen
William Braid White
Eugene F. Carey
Arthur E. Nealy
A. Snyder

World Office
Republic Bldg., 209 South State St., Chicago
Telephone: Wabash 5774

CHICAGO, ILL., July 10.—“Right now, when warm weather is supposed to bring me a breathing spell—when I am supposed to let business go by the board and get out of town on my vacation—right now I’m getting in my best work.” said a well-known Chicago wholesaler. “Do you remember that old gag—something about opportunity knocking at the door? Well, it’s true now if it ever was true. The old dame stands just outside the door of every talking machine man’s establishment in the country with money bags bulging under each arm.”

Roughly, but aptly, this expresses the ideas of a certain percentage of foresighted Chicago talking machine men, retailers as well as wholesalers. There seems to be an intention on the part of many to “make hay while the sun shines,” and accomplish during the summer what could not be accomplished if left until the fall. A desire to “get the jump” on the other fellow is apparent. It is the consensus of opinion that next fall will bring the apex of demand, that the holidays will offer a golden opportunity for establishing businesses upon firm and permanent footings which will outlast the present “boom.” Another reason for the unusual hot weather activity of many local talking machine men is the fact that although machines are hard to get now they will be much harder to get in the fall and it behooves both dealer and manufacturer to keep busy.

Local dealers are not losing sight in the mad scramble for machines of the fact that prestige and a reputation for conscientious dealing count for the most in the long run and that the narrow-minded policy of selling for the present, oblivious of the future, will in time eliminate the man who pursues it. The broader tendency is evident in local newspaper advertising, service to customers and window displays. Now, when the demand is so far in excess of supply, when there would seem to be the least call for effort in keeping one’s goods before the public, now the most progressive merchants are striking out with utmost energy. No other June or July has seen as much newspaper advertising of talking machines, or window displays of anywhere near equal merit.

Wholesalers are pursuing the same policy in regard to their distributors. They realize that

now it is up to them to do their best by their dealer clientele, as the latter have done their best in slacker times. Although greatly oversold and assured that all output will be contracted for months in advance, the service was never better nor the desire to match increased output with higher quality more apparent. Building for the future seems to be the end toward which the majority of manufacturers are working. There are some on the other side of the fence, but they are as visible as a black dot of ink on a white sheet of paper.

Good Local Window Displays

Window displays of more than usual merit appear in a number of Chicago downtown talking machine houses. The fact that machines are scarce and hard to get seems to have had no detrimental effect upon the expense and energy expended in trimming the windows, nor has the coming of warm weather and what is usually termed the slack season had any backward effect in this matter; in fact, the talking machine window displays of the present time, if anything, are of a higher degree of excellence than has been seen since the first of the year. A number of merchants believe in the theory that a prospect starts “thinking” of buying in the summer or early fall and “makes up his or her mind” in the holidays. It then follows that the store which attracts the first favorable attention gets the ultimate business.

Lyon & Healy have had a most pleasing “real life” window of a summer place in the mountains, with a Victrola as the center of interest. The display appears in the large corner window of the Lyon & Healy store and lends itself admirably to this sort of a display. Around the edges of the window runs a little brook in which live fish to the number of some half-dozen or more are swimming. A miniature waterfall throws water down over mossy rocks into the stream and in a number of places along the “brook” air-bubbles can be seen continually arising from the bottom. Along the side of the stream a few birds, excellent specimens of the taxidermist’s art, stand in lifelike attitudes. At the rear of the window stone steps and an arch are pictured, leading back to a villa. From the arch hang great numbers of flowers, creating a very pleasing effect. A most

lifelike, breezy out-in-the-open-air atmosphere is attained throughout the display, which starts one immediately thinking about vacation; but the happy mother and small boy listening to the instrument do not permit one to forget that the talking machine is a necessary part of the outing.

Quite another type of display, yet none the less original in its way, is that appearing in the Wurlitzer window, featuring the two records, “Alcoholic Blues” and “How Are You Going to Wet Your Whistle.” A representation of a Victrola, with the doors, turntable, tone arm, sound box, lid, winding lever, etc., bears the name “Dry-Ola.” This talking machine, constructed entirely from a beer keg, would seem a most appropriate instrument upon which to play the two funereal selections above mentioned. At any rate the people gazing in at the “Dry-Ola” with moistly interested eyes seem to voice their approbation of the display.

The Talking Machine Shop, exclusive Victor retailers of Chicago, are running true to their usual form in putting on a summer display which attracts the attention of the passerby immediately. Against a background of red brick, representing a homestead typical of millions throughout the United States, is built a small porch with very limited space. Upon this porch a Victrola, some records and two comfortable wicker chairs are placed and demonstrate what the small porch of the average family dwelling affords in the way of summer musical entertainment. The red brick background, gray and white railings of the porch, green lawn and flowers make up a most harmonious whole, well calculated to get action out of the man who has no talking machine on his porch.

The Brunswick Shop have a timely window in which a June bride is pictured as bending over the gift of a Brunswick instrument, enraptured with the music she hears. The figure is made of cardboard and dressed with silk. At one side of the window a large jardiniere of flowers is set, lending a colorful effect that is pleasing.

New Store in Benton, Ill.

The Southern Illinois Music Co., which has for some time past operated the thriving music establishment at Du Quoin, recently opened a
(Continued on page 103)

We are glad to announce that we will resume our Original Prices on

THE “WADE” FIBRE NEEDLE CUTTER



The Wade

Fibre Needle Cutter No. 1 Price \$1.50

HURRAH FOR PEACE!

Special attention—
Read above—

“Not how cheap but how good”

Write for samples and Trade Discounts or Order From your Regular Distributor



The Wade

Fibre Needle Cutter No. 2 Price \$2.00

WADE & WADE, 3807 Lake Park Ave., Chicago, Ill.



20th Century Victrola Advertising

Newspaper advertisements
which attract attention and
build sales.

Literature for mailing which
directs the local trade to
your store.

Window advertising which
centers the interest of the
public in you.

These are a few of the Advertising
Services we offer Victor Dealers.

Samples Free

Order a "SILENT SALESMAN,"
listing Victor Records, for your
counter. You will like it; in case
you don't, send it back; price \$9.00.

Lyon & Healy

Victor Distributors

CHICAGO

FROM OUR CHICAGO HEADQUARTERS—(Continued from page 101)

new store in Benton. C. D. Durham, manager, stated that the stock of the Southern Illinois Music Co. has been increased from \$2,500 to \$10,000 so as to enable them adequately to take care of their increased business. The company handles Edison and Columbia talking machines.

Big Opening at Decatur

The Linn & Scruggs Drygoods Co., of Decatur, Ill., held the formal opening of their new music department last month. The building in which the talking machine and piano departments are housed consists of three stories and a basement. The first floor contains demonstration booths, some talking machines and a stock of player-pianos. On this floor also is located the office of the manager, W. E. Rauch. The concert hall for the demonstration of talking machines and pianos is on the second floor. The third floor has a repair room and the basement is used for storage.

A "Get Together" meeting of all those connected with the newly established department was held on the morning of the "opening." In the afternoon a musical program was given at the recital hall with vocal and instrumental numbers rendered by prominent artists. Representatives Putnam and Page, of the Stewart Phonograph Co., Victor jobbers of Peoria, Ill., and Springfield, Ill., respectively, gave Linn & Scruggs a luncheon on Wednesday noon, and in the evening the Sonora Talking Machine Co. gave a Sonora supper. It may be mentioned in passing that the Packard Piano Co. started the ball arolling in the morning with a Packard breakfast. It is evident that Linn & Scruggs were well fed on the eleventh.

Vitanola Post Advertising

The Vitanola Talking Machine Co. recently inserted some very interesting and effectual page advertisements in the Saturday Evening Post. "The Phonograph Plus at the Price Minus" is the title of one advertisement. In the opening paragraph of this page we find the name "Vitanola," explaining that the "vita" in their name

is the Latin word meaning "life." Numerous cuts and interesting text matter completed the company's advertisement.

Columbia to Be in New Offices

The Columbia Graphophone Co. plans to remove in the near future from its present location, 12 North Michigan avenue, to new quarters in the McNeil Building. The Chicago branch will then have one of the finest wholesale display offices in the country. A complete model store with new record racks, counters, and booths, modernly equipped throughout, will be constructed and on exhibition at all times for the convenience of visiting dealers. Plans for the offices in the McNeil Building have been completed and construction started, but the Columbia Co. does not expect to be able to move for a short time yet.

Traveler Undergoes Operation

H. H. Michaels, traveling representative for the Chicago Talking Machine Co., Victor jobbers, recently submitted to a serious operation for stomach trouble in the Presbyterian Hospital. His friends will be glad to know that he is now practically out of danger and will soon be again calling upon talking machine merchants in Michigan and Indiana.

Rapidly Recovering His Health

John H. Steinmetz, president of the Empire Talking Machine Co., recently underwent an ocular operation in St. Luke's Hospital here. The operation occurred a few weeks ago and was an entire success. Mr. Steinmetz recovered quickly and again resumed his activities as chief executive of the Empire Talking Machine Co.

Crops and Talking Machines

C. E. Hitchcock, of "Hitchcocks," Wellington, Kan., believes in music and agriculture. He is in both businesses and just now finds both in a great state of prosperity. His son, R. W. Hitchcock, now actively in charge of the Wellington music house, sends the accompanying photograph of himself and father in one of their

wheat fields to the Brunswick-Balke-Collender Co., whose product they handle. The picture gives a good idea of the Kansas wheat crop of this year and promises many good things for the established music dealer.

"You will notice that the wheat is almost shoulder high," writes R. W. Hitchcock, "and of the very finest quality. We will harvest 450 acres of wheat on the farm this year and from



C. E. and R. W. Hitchcock in a Wheat Field the looks of things around here we begin to think that you people will get all the money."

Just Goes and Gets Married

Another A No. 1 saleswoman is lost to the Chicago talking machine trade! Miss Ruth Steele, who formerly had charge of the talking machine department of the P. A. Starck Piano Co., has been married to Captain Patrick F. Machler, who commands the hospital for wounded soldiers at Newport News, Va.

Visitor From the West Indies

A. Melenedez, music merchant with interests in the West Indies, is in Chicago with a big smile and a store of optimism regarding the music situation in our neighboring islands. Mr. Melenedez is here visiting his brother, who is employed with Armour & Co., and has stated that he intends to remain in the city for a month or two. He has a home in Havana, Cuba, where his largest musical house is established. He carries a number of lines of musical instru-

(Continued on page 104)

Your Account With Us



Will Be an Insurance Policy Against
 EMPTY RECORD SHELVES LOSS OF CUSTOMERS
 LOSS OF PROFITS

Record Dealers Reach the Acme of Wisdom
 WHEN THEY STOCK UP WITH POPULAR HITS ON



No Waiting for Delayed Shipments When You Order From Us

MAGNOLA TALKING MACHINE COMPANY

711 Milwaukee Avenue

OTTO SCHULZ, President

CHICAGO, ILL.

FROM OUR CHICAGO HEADQUARTERS—(Continued from page 103)

ments, as well as other musical specialties.

Now Occupy Entire Building

The Universal Stamping & Mfg. Co. announce this month that they have taken over the entire building wherein their plant and offices are located. The size of this building is 250 by 140 feet and is devoted exclusively to the manufacture of "Universal A6" three-spring motors and turntables, as well as the "Universal Auto Stop," "Star Stop" and "Sure Stop." One of the unique features of this factory is in the remodeling of a large room which was made absolutely soundproof. The walls, ceiling and floor of this room are made of very thick concrete. This room is devoted entirely to the testing of "Universal" motors and the men



Plant of the Universal Stamping & Mfg Co.

working herein are highly specialized in this art. The men work with stethoscopes as part of their equipment, and with the aid of the afore-said apparatus are able to detect the slightest sound that may possibly emanate from the motor. Their object is in the main to inspect each and every motor and see that it is absolutely noiseless before going out of the factory.

During the war the Universal Stamping & Mfg. Co. were turning out a great amount of special mechanism used in 75 millimeter guns, and the same employes that were working on this mechanism are now employed in the building of Universal motors and automatic stops. In doing this work the mechanics worked from French blueprints and thereby became well acquainted with the metric system of measurement. The machinery that was used in the manufacture of these parts is of the highest grade and all work turned out by them is accurate in every detail.

Change Store Name

Hereafter the George P. Bent retail piano and talking machine store, located at 214 South Wabash avenue, will be known as the "Chicago Music Center." Under the management of George Harry Bent and Charles Bent, just returned from service overseas, the store plans extensive campaigns for summer and fall business. George P. Bent, founder of the house, has retired and recently gave a farewell dinner to his many friends in the trade. After a two

weeks' fishing and hunting trip in the woods of Wisconsin Mr. Bent will leave for his California home. The "Chicago Music Center" will continue to handle the complete Victor line of talking machines and records.

"Blues" In Alabama

Why is it that just now "Blues" seem such wonderful sellers? Is it because of the great drought that has struck the country, or just because this weird music appeals at any time in any place to the millions of people who have discovered it? John H. Steinmetz, president of the Empire Talking Machine Co. and manufacturer of the Empire records, cites an instance of the remarkable sale of this type of record in the South. The Music Exchange of Birmingham, Alabama, recently received a large shipment of "St. Louis Blues," Empire records, on a Saturday morning, and sold the entire lot before evening, with prospects of a big night's business yet to come. But then, sectionally speaking, why shouldn't "St. Louis Blues" be popular in "Alabama"?

Attend Edison Convention

C. E. Goodwin, president of the Phonograph Co., large Edison jobbers of this city, accompanied by L. A. Sutfin, H. D. Buchanan and J. R. Kittleredge, all prominent Edison men of Chicago, left the last week in June to attend the Edison conventions in New York. A special train, upon which was carried all of the Western Edison men attending the convention, left Chicago a few days previous to the New York opening date. The conventioners stopped off at Niagara Falls on their way East and were enabled to enjoy the trip through the Hudson River valley by daylight.

Carload Lots a Success

Otto A. Gressing, sales manager of the Vista Talking Machine Co., of Port Washington, Wis., who has strongly pushed the idea of wholesaling talking machines in carload lots, reports marked success of the method. He believes that dealers are ready for the carload-lot plan, especially with the trade in its present condition. Mr. Gressing states that O. O. Dice, well known to the talking machine trade, is now covering the Illinois territory, and that E. E. Kolar is traveling in Indiana.

Crystola Agency Here

Francis Evans, of the firm of Evans & Davis, has been placed in charge of this concern's newly acquired Crystola agency. Mr. Evans has just returned from service overseas and takes up his new duties with great enthusiasm. He expects to establish a number of agencies all

over the country before the end of the fall. Evans & Davis are marketing the Crystola, not only in the Middle West, but in all parts of the United States. Besides talking machines this firm handles a number of well-known lines of pianos.

Meet Need for "Popular" Model

The Usona Talking Machine Co., which has been in the talking machine manufacturing business for over three years, has recently produced a new model designed to meet the great present-day demand for a machine of the cabinet type retailing under \$80. J. D. Keating, president of the company, has found from his long experience in dealing with retail merchants, that the



J. D. Keating

substantial cabinet model retailing at a price ranging between \$70 and \$80 is pre-eminently the machine in need by merchants at the present time. "The spring and early summer," says Mr. Keating, "have developed an enormous demand for this type of talking machine, and the fall and holidays will witness a further increase in the sale of machines at this price. It is true that there is, and will be, a great call for the higher-priced models, but there is no getting around the fact that the instrument retailing for \$100 or less is the dealer's real source of revenue. However, this does not mean that a 'cheap' or inferior type will get across. Talking machine buyers are becoming more and more judicious in their selections every year and the lower-priced models must be well and artistically made."

Mr. Keating is well acquainted with all branches of the trade, and has had years of experience in the manufacture and marketing

(Continued on page 106)

TRANSFER NAME-PLATES

We make the Transfer Name-Plates and Trade-Marks for the largest talking machine manufacturers in this country and for dealers in every state.

YOUR NAME, Mr. Dealer, on every machine brings the owner back to you for records and his friends to you for a machine.

Samples, Suggestions and Sketches Furnished Free

THE MEYERCORD COMPANY, CHICAGO

Largest Manufacturers of **DECALCOMANIA** Transfer Name-Plates

UNIVERSAL

THE MOTOR YOU WILL EVENTUALLY BUY

PERFECT
IN
MECHANISM

NOISELESS
IN
WINDING

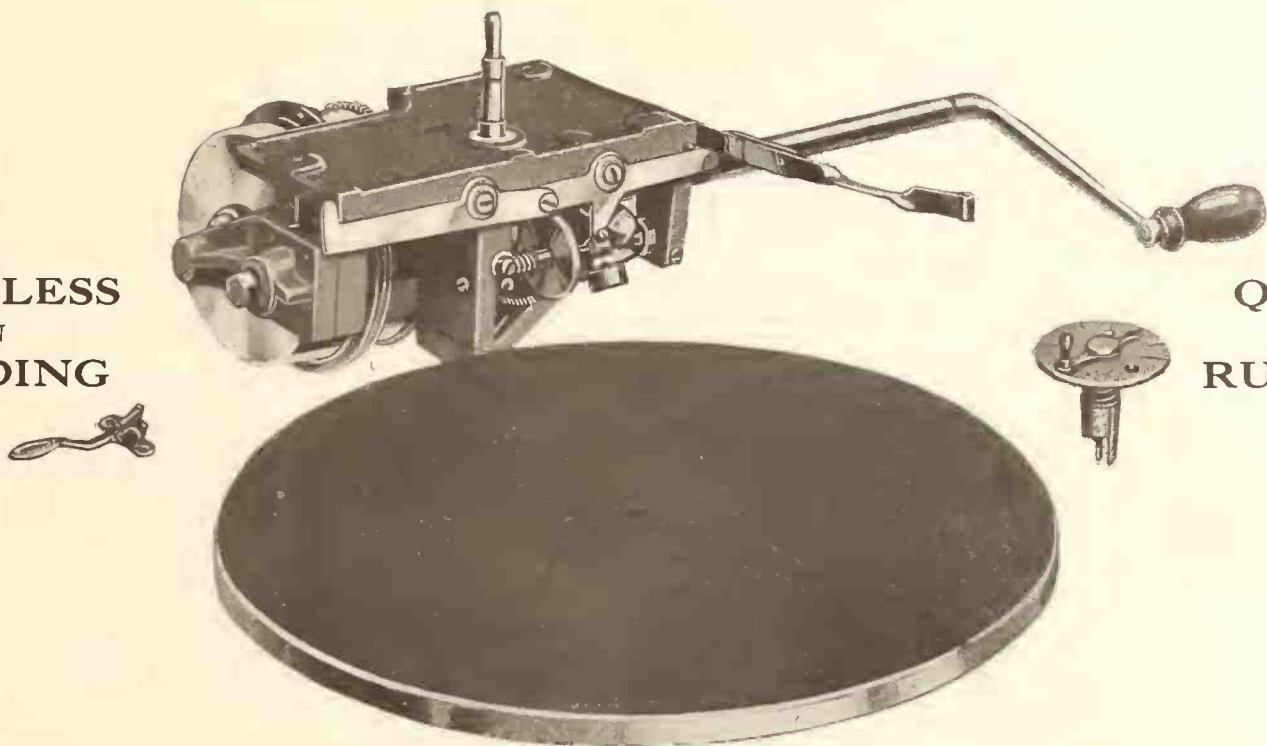

QUIET
IN
RUNNING

IMMEDIATE DELIVERIES

ALSO MANUFACTURERS OF
UNIVERSAL AUTOMATIC STOP — STAR STOP — SURE STOP

SAMPLES and PRICES on REQUEST

Universal Stamping and Manufacturing Co.

1917-1925 SO. WESTERN AVENUE

CHICAGO, ILL.

The Oro-Tone

QUALITY FIRST

FOR THE PERFECT REPRODUCTION OF ALL DISC RECORDS ON THE SUPERB EDISON

Has received the endorsement of the largest Edison dealers. It operates with the lever the same as the regular Edison reproducer. To see it is to admire. Hear it and be convinced.

Shall we send sample on approval?

Retail Price, Nickel Plated, \$8.50 Highest Grade Gold Plating \$12.50

Mfrs. of highest grade tone arms, reproducers, attachments for phonographs for playing all records. Diamond and Jewel point needles, motors, supplies, etc.

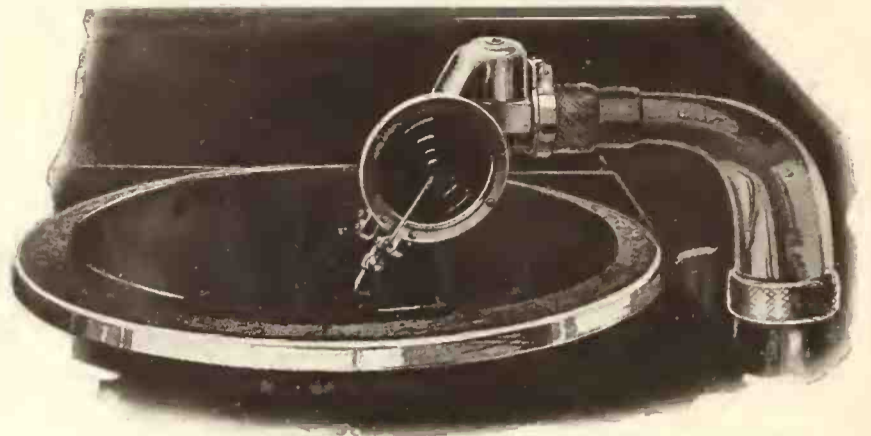

The Oro-Tone Co.
QUALITY FIRST

Successors to COMBINATION ATTACHMENT CO.

1808-10 IRVING PARK BOULEVARD, CHICAGO, ILL.

FROM OUR CHICAGO HEADQUARTERS—(Continued from page 104)

of machines both by direct sale and by mail orders. He was formerly connected with the Mazophone Co. in the capacity of general sales manager, where he came into close contact with talking machine people all over the country. The product he now manufactures has been upon the market for three years and includes an extensive line of instruments from the "popular model" above mentioned to art and period styles.

Now in New Location

The Phoenix Phonograph Co. is now located in its new plant at 2504 to 2506 West Van Buren street, this city. This company has been for the past five years manufacturing talking machines for the local trade, mainly, but have now decided upon going after the trade this fall. At present they have four models on the market, but it is their intention to change these styles within a very few weeks.

Vocalions Attract Trade

The firm of Bissell-Weisert, located in the Fine Arts Building, have been carrying in the daily papers advertisements of the Aeolian-Vocalion which possess extraordinary merit. The Bissell-Weisert company in both their piano and talking machine advertising appeal to a very high class of trade, in fact, the shops along our Boul Mich compare favorably with those of Fifth avenue in New York or the Rue De La Paix in Paris. So the Bissell-Weisert advertis-

ing, whether of talking machines or of pianos, is bound to bring in results commensurate with their merit.

"Actuelle" Visits Chicago

The Actuelle paid a short visit to Chicago the first part of the month and met quite a number of Western Pathé dealers, while demonstrating in several of the Pathé jobbers' warerooms in Chicago. It was introduced by W. W. Parsons, Pathé special representative, who is making a Western demonstration tour for that company. Mr. Parsons, who is a well-known figure in the Chicago trade, treated his many friends to a series of musicales, the artist of course being the Actuelle. It was the first time this new instrument was seen in Chicago. A great number of talking machine men took in the performances. All were highly pleased with the demonstration and thanked Mr. Parsons heartily for inviting them to the entertainment. Mr. Parsons took in several large towns in Illinois after leaving Chicago, and then started on a general tour of the Central Western States.

Home-Made Jazz Music Overseas

At the present time two Chicago boys and a third from the South, where jazz music is said to have originated, are popularizing the new American (alleged) music in France and Germany by the aid of home-made instruments. The two Chicago lads are J. H. Joyce and Andrew N. Nelson and they have made for them-

selves ukuleles, especially adapted to jazz music, from logs said to be fifty years old. And now they're wondering why the talking machine record men of the country always wear smiles and do such a large business.

New Hiawatha Model

The new addition to the Hiawatha Co.'s plant, announcement of which was made last month, is rapidly nearing completion, and the officers of the company announce that from present indications the space will be ready for occupancy about the middle of the month. The addition consists of a one-story building and basement, located at the side of the present plant, and the plans of this provide for a foundation strong enough to take an additional three stories. Free Moynahan said that the Hiawatha business has been growing to such an extent that they made this provision in the new building so that they

AMBEROLA SERVICE

As the Edison Cylinder products are not controlled by zone system, dealers anywhere can take advantage of **LYONS' SERVICE**; which is efficient, skilled, and up-to-date.



Contrary to the general impression, the cylinder line **IS NOT A THING OF THE PAST**. It is absolutely the best value offered the public today.

J. I. LYONS

17 W. Lake St.

Chicago

Equip Your Phonographs With Perfect Automatic Brakes

Samples \$1.00 Each
Cash with order
State make of tone arm used



Also made with long brake shoe for 1 inch offset

Patented Aug. 28, '17

Simple construction and easily attached. Made in four styles to fit any make of tone arm.

Write for attractive quantity price

PERFECT AUTOMATIC BRAKE CO.
Room 400, 425 S. Wabash Ave., Chicago

Repair Parts

For All and Every Motor That Was Ever Manufactured

WE can supply any part. The largest and most complete assortment of repair parts—in the United States—on hand, for old, obsolete and present-day motors. If your order cannot be filled from stock, we will make it up special.

Special prices on main springs, governor springs, micras, repair parts, motors, tone arms, steel needles, etc., in quantity lots.

Expert repairing on all makes of phonographs and motors.



INCORPORATED UNDER THE LAWS OF ILLINOIS

Consolidated Talking Machine Co.

Manufacturers of

SUCCESSORS TO
Standard Talking Machine Co.
United Talking Machine Co.
Hornum Talking Machine Co.
O'Neill-James Co.
Arethe Co.

High Grade Talking Machines, Disc Records, Talking Machine Supplies, Etc.

227-229 West Washington Street, CHICAGO, ILL.



TRADE MARK "CONSOLA"

CABLE ADDRESS "CONSOLA"

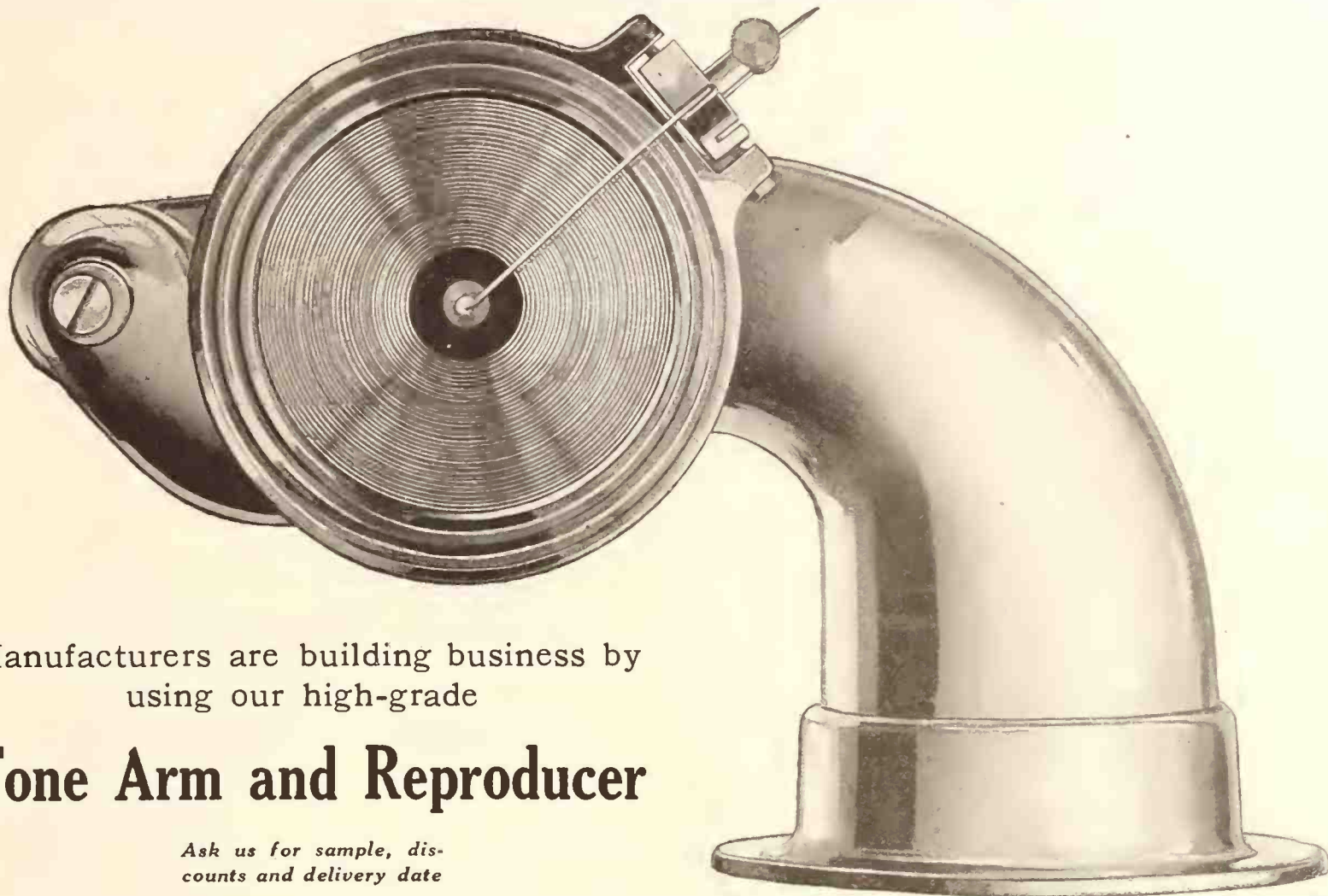

Manufacturers are building business by using our high-grade

Tone Arm and Reproducer

Ask us for sample, discounts and delivery date

Jewel Phonoparts Company

59 E. Van Buren Street

Chicago, Illinois

FROM OUR CHICAGO HEADQUARTERS—(Continued from page 106)

could take care of future increases in their production. This new addition will allow them to increase their present capacity to practically double. Mr. Moynahan also announced that they are working on a new and unique model Hiawatha talking machine that will retail at about \$1,000. It is expected that this new instrument will be ready for the trade in time for fall delivery.

Western News Agencies Active

The channels through which the Western News Co. market their instruments seem to have been enjoying particularly satisfactory business during the entire month of June and the early part of July. Demands made upon this concern have taxed their output severely, but according to the executives of the company increased facilities have taken care of the increase in demand.

Cards Bring Needle Sales

The artistic little placards prepared by F. D. Hall, president of the B & H Fibre Mfg. Co., for the use of retail talking machine merchants in calling the attention of customers to the merits of the B & H Fibre needles, have already produced results in the increased demands made upon the B & H Fibre Mfg. Co. during the past thirty days. This concern has materially increased its manufacturing facilities to accommodate the ever-increasing demand made upon it, but in spite of this and of the month of June, which usually brings with it a decided reduction in demand, the B & H Fibre Mfg. Co. is extending itself to the utmost in order to keep up with present orders.

"Inspirational Business"

E. P. Van Harlingen, Western representative of the Talking Machine World, published and distributed to his friends at the recent trade conventions in Chicago a little booklet entitled "Inspirational Business." Upon the cover of the booklet was written at the bottom of the page "What shall we do with the conventions when they are over?" Following this came an intro-

duction voicing an appeal for higher ideals in business ethics. The author is only just recovering from an unfortunate accident of a few months ago, and the little publication was in the way of a greeting to his friends. Any who wish to have "Inspirational Business" will receive one upon request.

Good Business in Hardware

Cole & Dunas report favorably concerning their trade in talking machine hardware. The past month, although a little slower than early in the spring, has been very satisfactory and is many times better than the same month in any previous year. "I am confident that a large number of machines and records will be sold right through the hot weather," said Mr. Dunas. "The manner in which business has held up during the first hot weeks of the year convince me that there will be very little let-up."

Cole & Dunas have become distributors for the Krasberg motors, which they intend to push strongly. Another new item added to their catalog is a rotometer for indicating the proper revolutions per minute of talking machine turntables.

Catching Up on Deliveries

The Western office of the Sonora Phonograph Corporation finds itself in a slightly better condition so far as back orders are concerned.

The company is taking no new applications, but last month an account was opened with the C. H. Pill Furniture Co., of Fort Dodge, Iowa, a concern which had entered its application for Sonora machines quite some time back. The C. H. Pill Furniture Co. will handle a complete line of Sonora machines and accessories and will continue to handle the present line of Windsor models. "It is significant of the conditions in the trade at the present time that accounts filed three or four months ago are just being filled," said Mr. L. Golder, of the Western office. "There is to be no 'off season' this year."

A Progressive Department

Mandel Bros., well-known department store of Chicago, maintain on their ninth floor one of the finest talking machine businesses in Chicago. The small section opened three years ago has grown steadily, and now comes word that in the fall eight more sound-proof demonstration booths are to be added. O. C. Searles is in charge of the department and handles the complete Columbia and Aeolian Vocalion lines of instruments and records. The arrangement of the department is particularly attractive and suitable to an establishment of this sort. In a spacious center room a number of models are on exhibition and all around this are demonstra-

(Continued on page 109)

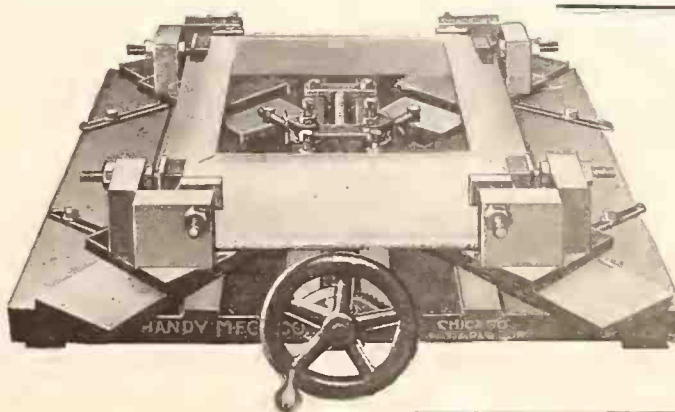

We illustrate the

"Handy" Dome Clamp

Quick action for clamping domes and frames on Talking Machine Cabinets.

Write for Catalogue of clamping machines for Cases and for all purposes

VENEER PRESSES AND CLAMPS

HANDY MFG. CO.

27 E. Madison St., Chicago, Ill.

ONE OF THE FINEST PHONOGRAPHS

We Might Say *The Finest*
We Say *One of the Finest*
Because——

Our phenomenal success in the past year permits us to make this statement and prove every word of it.

If we were to substitute a word for the name Hiawatha that word would be quality.

Our tremendous increase in business is due to quality.

We are now enlarging our present plant, which will mean an increased production — in fact double our present output — this proves conclusively that the keynote of our success is due entirely to our quality phonographs.

Mr. Dealer: You should handle one of the finest phonographs and let Hiawatha quality be your trade mark.

Your initial order for one Hiawatha will enable you to do so

Our policy is just as fair as our claim.

HIAWATHA PHONOGRAPH COMPANY

MANUFACTURERS

209 S. State Street, Chicago, Ill.

FACTORY: GENEVA, ILLINOIS

HIAWATHA
PHONOGRAPHS

Listen to this simple story
to this song of *Hiawatha*
LONGFELLOW



FROM OUR CHICAGO HEADQUARTERS—(Continued from page 107)

tion booths, a few of them facing upon State street where the disinterested spouse of the missus making a record purchase can devote his attention to the busy street below. Miss G. Beattie is in charge of the record department, which is located on one side of the main room. Upon glass counters appear the latest Aeolian-Vocalion and Columbia record bulletins, and advertising literature of these two concerns makes up a very excellent display.

Six Best Chicago Sellers

Record sales during the past thirty days, in spite of the approach of hot weather, have shown very little decrease. The "hits" are going strong, and promise to sell well all through the summer.

In Victor records the six best sellers, as reported at the Talking Machine Shop, have been: "Juanita" by De Gogorza, "When You Look in the Heart of a Rose" by McCormack, "Kiss Me Again" and "Humoresque." "Oh, Susy, Behave!" and "Monte Cristo, Jr." "When You See Another Sweetie Hanging Around" and "Mammy O' Mine," "Bring Back Those Wonderful Days" and "Jazz Baby."

In Columbia records the best sellers as given by Miss Beattie of Mandel Bros. are as follows: "Chong" and "Waiting," "I'll Say She Does" and "What Is Your Name," "Core'n grato" by Stracciari, "Madame Butterfly" by Rosa Ponselle, "A Good Man Is Hard to Find" and "That's Got 'Em." "Mary Anne" and "Bevo Blues."

The Edison six best sellers as given by the Edison Shop are: "L'Ardita-Magnetic Waltz" and "Sundown in Birdland," "Looking This Way" and "Some Sweet Day, By and By," "My Bonnie, Bonnie Jean" and "Nanny," "Mummy Mine" and "Me-ow." "In a Kingdom of Our Own" and "When the Cherry Blossoms Fall." "In the Land of Beginning Again" and "Mammy's Lullaby."

In Pathé records, as reported by the Brunswick Shop: "Sweet Hawaiian Moonlight" and "Lullaby Blues," "Chong" and "On the Ozark Trail," "Mammy O' Mine" and "Wild Honey," "Alcoholic Blues" and "Lassus Trombone," "I'll Say She Does" and "Fluffy Ruffles," "After All" and "Hindu Lady."

Six best sellers in Vocalion records as given by Miss Beattie of Mandel Bros.: "William Tell," "Call of the Cosy Little Home" and "Behind Your Silken Veil," "Don't Cry, Frenchy" and "Bluin' the Blues," "Mary Ann" and "Gypsy Girl," "Indigo Blues" and "Oriental Jazz." "Eyes" and "When Cherry Blossoms Fall."

In Emerson records: "Shadows" and "Wild Honey," "Mammy's Lullaby" and "Hawaiian Moonlight," "Yama Yama Blues" and "Church

Kaumanns & Co.

Importers and Manufacturers

21 EAST VAN BUREN STREET

CHICAGO, ILL.

"ALL-IN-ONE"

Attachments

for

**Victor
Columbia
Edison
Machines**

"ALL-IN-ONE"

Speed Indicator

Registering

78 and 80

Revolutions

Street Sobbing Blues." "Rainy Day Blues" and "My Rose of Palestine," "Alabama Lullaby" and "I Found You," "Everybody Wants a Key to My Cellar" and "Golden Wedding Jubilee."

In Empire records: "When You Look in the Heart of a Rose" and "By the Camp Fire," "Somewhere in Hawaii" and "Oh, Mari, O Maria," "Slim Trombone" and "Yellow Dog Rag," "You're Still An Old Sweetheart of Mine" and "Honey Lamb." "Full O' Pep" and "The St. Louis Blues," "My Old Kentucky Home" and "Hawaiian Nights."

Demand for New Tone Arms

The demand for a quickly adjustable tone arm seems to have resulted in the case of the Fletcher-Wickes Co. in an unusually large bulk of orders during the month of June. According to this concern manufacturers of cabinets and those who assemble talking machines for wholesale distribution intend to leave no stone unturned in their efforts to attain a maximum output during the hot weather.

Artistic New Catalog

The Nightingale Mfg. Co., of this city, manu-

facturers of the Nightingale talking machine, has just produced a very fine specimen of talking machine catalog. It is printed upon special multi-colored stock, elegantly illustrated throughout. The booklet makes a very handsome appearance.

Advertising With Blotters

The World Phonograph Co. has recently printed great numbers of blotters, bearing two illustrations of the well-known World phonograph in Adam, brown mahogany and golden oak, and the true color with the interesting text matter make up a very effective little card.

Book on Retail Management

"There is money—good money—in the right kind of a talking machine department," says the Vitanola latest service booklet, "Making a Phonograph Department Pay." "Merchandising anything nowadays is more than ever a matter of brains—buying brains as well as selling brains. And ideas are what brains feed and thrive on. Thus many say, 'Ideas are the very life of business,' despite that old saying about

(Continued on page 110)

Going Fishing This Month?

You'd be in a nice fix if you went without your fishing equipment. Wouldn't you?

Ever stop to think that trying to land a talking machine prospect with an imperfectly equipped instrument is exactly like trying to fish with a bent pin? It can be done, after a long struggle—sometimes—but your chances are slim. Equipment counts.

THE CHICAGO COVER BALANCE No. 4

is the Acme of Cover Balance Perfection and a guarantee of equipment superiority that proves itself a major factor in landing the most exacting prospect.

It's Controlled by a Touch!

and is instantly adaptable, by means of its new method of anchorage, to either angular or curved talking machine covers.

Samples sent FREE to Manufacturers

We also manufacture EMPIRE TOP HINGES

Send for our new catalogue just off the press

Chicago Hinged Cover Support and Balance Company

2242-44 W. 69th Street Telephone Prospect 250 CHICAGO, ILLINOIS

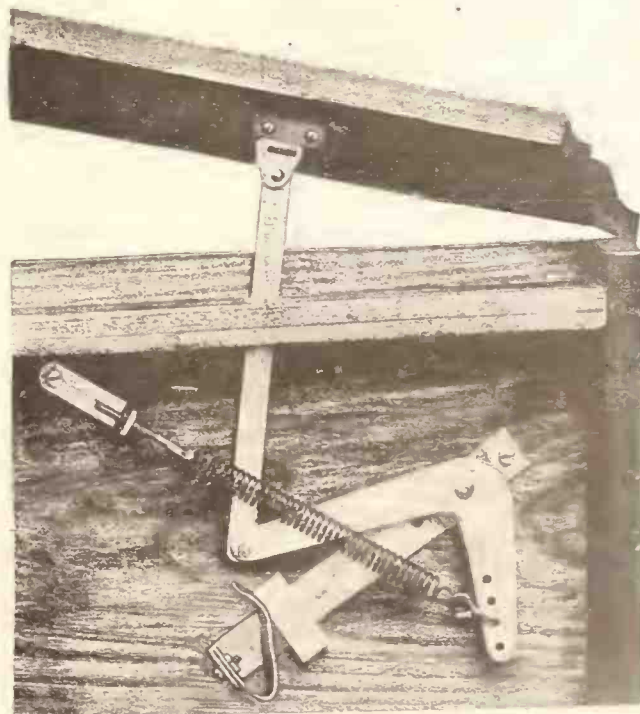

Perfect Cover Balance No. 4
(Patent Applied for)

FROM OUR CHICAGO HEADQUARTERS—(Continued from page 109)

competition, holding that distinctly important position.

"It is in the selling end of the game that ideas play perhaps the larger part. Realizing this, the clever, aggressive merchant is always on the lookout for new thoughts and suggestions, new merchandising plans that can be added to his fund of original conceptions and turned to definite advantage in his business."

"Making a Phonograph Department Pay" will be found a valuable little brochure for any retail merchant to look over, whether or not he handles Vitanola talking machines. Throughout the booklet on every page, under the title "New Sales-Building Hunches," appear personal accounts from Vitanola dealers, citing original and effective ideas for marketing talking machines. How one dealer utilized the circulating record library idea for increasing talking machines sales; how another made profitable appeal to possible buyers by attracting little children to his store Saturday morning with a "Story Lady" hour; how an "inside" salesman utilized the slack periods of the day in securing "outside" business; how a high school building was used during the summer for giving free dances with the aid of a talking machine; how a factory superintendent was convinced of the value of a talking machine in keeping his workers contented—all of these and numerous other highly original schemes are listed in the book.

An article entitled "Where the Money is in the Phonograph Business" gives a straight-from-the-shoulder talk from manufacturer to retailer. Another entitled "Frankly, You Need More Than Just a Good Phonograph" points out the necessity for co-operation and service between the manufacturer and merchant. The book is printed in a cobalt blue and is filled with artistic illustrations. The cover bears a gold embossed imprint of a Vitanola model.

On Vacations

Miss Pauline Tishler, Miss B. Bren and Miss F. Hamilton of the Talking Machine Shop are

away on vacations. Miss Tishler, well known to visitors to the Talking Machine Shop record department, has selected Denver, Colorado, as the place in which she will spend the summer.

Colored Record Arouses Interest

Miss G. Beattie, in charge of the record department of Mandel Bros. department store, reports great interest aroused as a result of the Aeolian-Vocalion's new colored record just placed upon the market. The color idea is something entirely new and causes a number of sales merely because of its novelty, aside from its musical merits.

Critic Reviews Conventions

Herman Devries, prominent Chicago artist and musical critic of the Chicago Evening American, highly impressed with the activities of music men in their efforts to spread the gospel of better music and better musical instruments, writes at length upon this interesting subject in the columns of his paper. He treats of the problems of musician and manufacturer and points out the mutual benefits to be derived from the closer co-operation of these two. Mr. Devries believes the music men made art possible and that Chicago occupies an important place as one of the future musical centers of the world.

"Chicago is giving an impetus to the musical industries in keeping with the advancement of music in America," he says. "The manufacturers have done more, probably, to advance music in this country than any other element that has had to do with this educational feature of life."

"There is fast being created throughout the length and breadth of this land and throughout the world, if you please, a greater and greater demand for music. I predict that this country is fast approaching the point where it will become the greatest musical nation in the world, and we must give credit to the men who have laid the foundation for this great advancement."

"To my mind the greatest move that has been made occurred right here in our own city of

Chicago in this movement toward the bringing together of the musicians and the commercial side of music to the end that there will be given more music to the public, which is becoming more and more insistent as to demand, and becoming higher and higher as to the quality of music that must be supplied."

Announce Price Increase

The Vitanola Talking Machine Co. announce an increase in price now effective in a letter mailed to all of their dealers, which says, "The percentage of increase indicated is less than the figures in present manufacturing costs over those which prevailed when our previous prices were arrived at. Raw materials have steadily risen until today the same articles are two or three times more than a few months ago. Primarily the cause of the increased costs of materials is the prevailing higher rate of wages. We believe it is fair and just that every person engaged in the industry should receive full benefit of his labor, and we would not, even if it were possible, reduce costs by cutting wages. Realizing the necessity of being equally as fair with our dealers as with our labor, we have increased list prices."

Leaves on Thousand Mile Trip

W. J. Cummings, president of the Phoenix Phonograph Co., Chicago, leaves on Monday for a thousand mile automobile trip with Mrs. Cummings. They plan to make this trip their vacation and will be gone two weeks, traveling to Cleveland, Detroit, Windsor, Ont.; thence through Canada to Niagara Falls, thence to Buffalo and back home via Cleveland.

S. A. Ribolla Visits East

Late in June S. A. Ribolla, the crack salesman of the Heineman forces and general manager of the Otto Heineman Phonograph Supply Co., of Illinois, made a business trip to the Eastern Heineman headquarters and took this opportunity to visit the new Meisselbach factory now in course of construction. Mr. Ribolla states that the new plant will be ready for pro-

"A Paragon of Excellence and Beauty."—Webster.

PHOENIX

"The same, plus the finest value imaginable."—The Trade.

WHY?

Because: The Equipment is the Best Obtainable: AND

The Large Output provides for IMMEDIATE DELIVERY.

We specialize on deliveries in carload lots.

DON'T FORGET

THE PHOENIX Plays All Records—
Perfectly



Phoenix Style C 50" High



Phoenix Style A 46" High

FOR FURTHER PARTICULARS WRITE

PHOENIX PHONOGRAPH CO.

1504-06 W. Van Buren St.

(Phone West 3629)

Chicago, Ill.

FROM OUR CHICAGO HEADQUARTERS (Continued from page 110)

duction of Meisselbach motors between the dates of September 1 and 15. He also stated that in the Middle West, his own territory, there was a marked increase in demand for these motors.

Interesting to the Trade

The Handy Mfg. Co., makers of all kinds of veneer presses, clamps and clamping machinery, are now placing on the market their "Handy" revolving all-steel-and-iron case clamp. This new device is made for the purpose of holding cases square while being assembled. The clamp is swung between two frames, so that it may be turned over at will by the operator. It



"Handy" All-Steel-and-Iron Case Clamp

is made of steel and iron and comes in three sizes. The pressure plate moves easily and the long two-inch screw permits it to travel thirty inches. After clamping the case it can be revolved to any angle, so that work can be done on either the front, back or bottom. The pressure is applied by a sprocket wheel thirty-five inches in diameter, which permits great pressure with little effort.

To Move to New Quarters

M. J. Eggleston, secretary and treasurer of the Sterling Devices Co., made the announcement this week that this new company has grown to such proportions within the last few months as to be obliged to seek larger quar-

ters. They have succeeded in making arrangements for larger and more ample space in the new building, which has just been erected across the street from their present location. This company is closely associated with the Krasberg Engineering & Mfg. Co. The Sterling Co. recently brought out a new model tone arm and reproducer and were about to make public mention of this fact when the representative of a large talking machine concern in Chicago dropped in for a friendly visit. He saw the new tone arm and at once brought the attention of his company to it, with the result that the company took over the new arm and reproducer for its exclusive use.

The drafting department of the Sterling Co. is now working on some new talking machine accessories and Mr. Eggleston says that in a very short time he will have another new tone arm and reproducer ready for the trade, as the blue prints are completed and work is being rushed on the first model.

The Latest!

It takes more than talking machine manufacturers and salesmen to point out the varied uses to which a talking machine can be put. The Chicago Daily News prints an interesting article entitled "Here Is Music De Luxe," which explains how two ingenious Chicagoans found the talking machine to be an indispensable necessity of life.

First there's Gus Ditrich, field marshal of the waiters at the Blackstone Hotel. Gus says the patter of an alarm clock in the morning outrages his nerves for the entire day. So he has rigged up an attachment between his alarm clock and his talking machine. Get the idea?

At ten o'clock every morning, or whenever waiters de luxe rise from their beds, Ditrich's clock jerks wide the doors of his talking machine and it sings good morning thus: "Oh, say can you see-e, by the dawn's early light—"

Well, that's all right, Gus, but listen to A. W. Parsons, Rogers Park, a clerk in a loop grain

office. Parsons said he had put his talking machine to an even more helpful task. He said the machine was "saving his life"! Parsons has a seven-month-old son, named Julius. Julius has a musical voice; it reaches high C at precisely 3:15 every morning. "Why not connect the talking machine by a string to my bed?" thinks he. "When the kid starts whimpering I can pull the lanyard and the machine would begin grinding out 'Go to Sleep, My Baby' and 'There's No Place Like Home.'" He tried it—and oh, "Rock-a-by Baby"! It worked like an anaesthetic.

Arthur Dunham, organist at Sinai Temple and leader of the Philharmonic Orchestra, gave it as his opinion that the talking machine would find many unusual fields of activity. The lowbrows, he said, found inspiration while they worked in ragtime; the intellectuals found that they better enjoyed a book or a visit to the dentist if there was a talking machine playing a grand opera repertoire.

Sells to Foreigners

Constantine Xides, salesman for the W. W. Kimball Co., joined this concern a few months ago with the intention of selling pianos and musical goods to his own people, the Greeks of Chicago. He has made "good" solely through his own original methods and strong initiative. Mr. Xides stimulates musical and dramatic entertainment among the Greeks and Turkish population, helping them arrange plays, musicales and so forth, and always appears in person at each of these entertainments, speaking on the advantages of music in the home. He always makes known the fact that he is an agent for a talking machine concern and in this way manages to close many prospects that might otherwise not have matured at all. The foreign element in Chicago has always been one of the big problems for Chicago talking machine retailers. How to reach them, inspire confidence and create favor for a concern's goods has been

(Continued on page 112)

NOW IS THE TIME

to look forward for your fall supply of tone arms. We are now manufacturing three distinct types of arms for use on any style and price of machine.

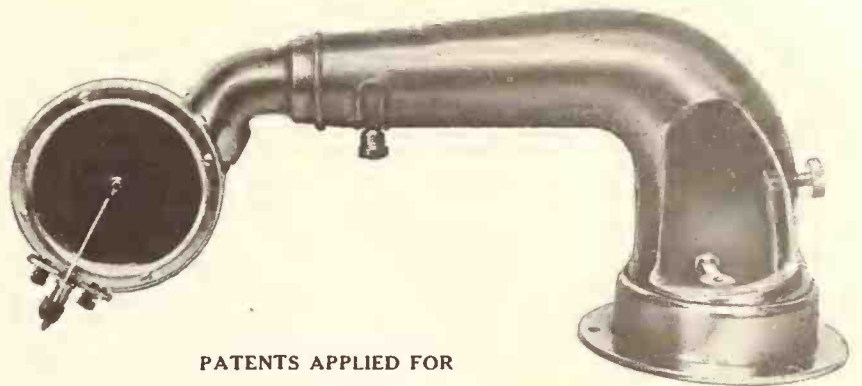

PATENTS APPLIED FOR

Just received a shipment of sapphire Jewels and Diamonds from Switzerland.

Don't forget we job "OkeH" Records and can supply you with all talking machine hardware and accessories. We carry a large stock of standard phonograph springs. Have you tried our "Phono" Oil, guaranteed not to gum?

Write for Special Conference Prices on Motors

Lakeside Supply Co.

416 So. Dearborn St., Chicago, Ill.

Tel. Harrison 3840



Have you a big supply of the great Columbia Mid-Summer Dance List, just out? You'll need it.

**Columbia Graphophone Co.
NEW YORK**

FROM OUR CHICAGO HEADQUARTERS—(Continued from page 111)

the object of almost every large merchant. A number of Chicago concerns have representatives traveling among these people, but the present instance of a piano salesman carrying on active musical propaganda among the foreign-speaking element is not only novel, but it is effective.

From Pianos to Talking Machines

W. A. Berry, for many years wholesale traveling representative for Iowa and the northwest for the Cable-Nelson Piano Co., and who since July, 1918, has represented the Baldwin Co. in the same territory, has resigned from the latter house and will enter the wholesale talking machine business at Des Moines, Ia., as a member of the firm of Kirkhart & Berry. The headquarters will be 603-605 Sixth avenue. They will market the Mocking Bird phonograph, which will be offered the trade in five attractive models, including four of the cabinet and one of the "table" type. It is announced that the firm will be ready to make deliveries on or about August 1.

STEIN-BURN CORP. DEVELOPING FIELD

Prominent Corporation Take Important Steps Toward Developing the Manufacture of Talking Machines—Their Plans in This Connection

CHICAGO, ILL., July 5.—The Stein-Burn Corp. of this city have recently taken some important steps toward the development of the talking machine business which are of special interest to the trade.

This company have in a quiet way manufactured talking machines of the better grade for several years for a few distributors, and but recently have developed their capacity to a large and important point. They are now adopting a policy of selling exclusively through dealers and have a sufficiently large capacity and extensive line of both standard and period models to make it seem probable that within a comparatively short time the Stein-Burn Corp. will be one of the leading institutions of the industry.

The men back of the Stein-Burn Corp. have been successfully identified with large business interests of Chicago for over forty years. The president of the corporation is Charles Stein; vice-president, A. L. Redlick; secretary, J. H. Seibly, and treasurer, B. F. Stein. Executive offices are maintained in the Westminster Building and the sales offices and display room for dealers are on the second floor of the Heyworth Building, corner Wabash and Madison streets.

The same interests that are identified with the Stein-Burn Corp. are also financially and actively interested in the Stein-Burn Camp & Field Equipment Co., and many other varied enterprises of large proportions, some of which are devoted to the manufacture of steel products, paper products, automobile accessories, wood-working, cabinet making, etc.

Steinburn phonographs, it is understood, are to be advertised extensively through national magazines, newspapers and trade papers. The merchandising campaign contemplates a goodly amount of local newspaper advertising of a predominating character, paid for by the Stein-Burn Corp. and bearing the name of the local dealer. Arnold Joerns Co., advertising agency of Chicago, have the advertising plans in charge.

The Stein-Burn Corp. have announced a number of important planks in their trade platform, among which the following are of special interest:

"1. Only one dealer in a town will be accepted.

"2. Each Steinburn phonograph carries a five-year guarantee in the form of a bond, which is given, the purchaser and which obligates the Stein-Burn Corp. to repair or replace without any charge any parts that may be defective.

"3. The Steinburn phonograph plays all disc records without any additional attachments and has a number of exclusive patented improvements, among which the new Reflectocurve throat is especially unique."

The Steinburn line at present contains eleven models ranging in list price from \$32.50 to \$450.00. The models include popular cabinet styles of both curved and square designs, also period models in Adam, Chippendale, Queen Anne, Louis XVI and Console models.

HEALY FAMILY HOLDS REUNION

Marquette Healy Host at Gathering of His Three Brothers and His Sister After Their Strenuous Work Abroad During the War

CHICAGO, ILL., July 7.—Marquette Healy, vice-president of Lyon & Healy, was the happy host at a family gathering July 4. Himself and his four "kids," that is, his sister, Mary, and his three brothers, Columbus, Vincent and Augustine, held on that day the first family reunion after a separation of two years during which time the kids were all overseas on active service. The little celebration was held at the Healy home at Lake Geneva.

Augustine, Vincent and Columbus got into service uniforms just as soon as America entered the war. Columbus entered the Officers' Training Camp at Ft. Sheridan and won a commission as first lieutenant. He was in the third division, which fought in the Argonne. Vincent and Augustine joined the Marine Corps, obtained commissions and went across early in the game. The next of the family to go was Mary, who enlisted in the Red Cross. For a while she was barred from overseas service because her brothers were already over there, but the ban was raised in September, 1918. Miss Healy then was sent overseas and was stationed at Colombey Les Belles, France, where she served until a month ago, actively engaged in hospital work.

However, before leaving home they all got their heads together and elected that Marquette, the oldest son of the founder of the firm of Lyon & Healy, should stay behind and keep the home and business fires burning for them. So Mark stayed home and attended to the business. When he got them all together again, which happened to be the Fourth of July, he had everything known in fireworks ready for their amusement and it goes without saying that "a good time was had by all."

VITANOLA CO.'S NEW PLANT

The Vitonola Talking Machine Co. is rapidly perfecting its plans for the new plant, which will cost nearly half a million dollars, in Chicago. The proposed buildings will be substantial fireproof structures of most modern type.

The annual report of the Brunswick-Balke-Collender Co. for last year shows a surplus after charges of \$1,162,562, or the equivalent, after preferred dividends, of \$13.73 a share on the common stock. This compares with a surplus of \$1,211,889 in the preceding year.

**YOU
GET THE CABINET
WE
DO THE REST**

For the Manufacturer who
Wants the Best Equipment
at the Lowest Price We
Can Supply Complete the

**MOTORS
TONE-ARMS
HARDWARE**

in Lots All Ready to make
Your Cabinet a Phonograph

ALSO

RECORDS and ACCESSORIES

*Our Merchandise Guaranteed
Write for New Catalog*

COLE & DUNAS MUSIC CO.
54 W. Lake St. Chicago, Ill.

FROM OUR CHICAGO HEADQUARTERS—(Continued from page 112)

EXHIBITS AT FURNITURE SHOW

Many Talking Machine Concerns Successfully Exhibit at Chicago Show—Large Volume of Business Transacted on This Occasion

CHICAGO, ILL., July 1.—The semi-annual furniture exposition, held in Chicago this year, has produced a highly satisfactory amount of business in both furniture and talking machine lines. All the talking machine concerns represented expressed particular satisfaction in this respect. Most of them have done from 50 per cent. to 100 per cent. more business than at any other previous exhibition. This probably is due to the general shortage of machines. Many exhibitors were forced to take all orders far in advance, the present output being completely taken up. Retail visitors to the exhibition have been plentiful, and all seem to possess great enthusiasm over the talking machine departments of their businesses.

The exhibits were held in two main furniture exhibition buildings in Chicago, located at 1319 and 1411 Michigan boulevard, and will continue till after the middle of the month. In these two buildings were the following exhibits:

The Vitanola Talking Machine Co. exhibited on the sixth floor of the building at 1319 Michigan Boulevard, with Sales Manager L. Samuels in charge. Mr. Samuels, who covers the territory between Chicago and Boston, had the following to say: "We have done a capacity business, far more than our expectations, right now during the summer months. The trade is better than it has ever been before, which is largely due to the fact that dealers are ordering ahead of time."

The Nightingale Mfg. Co. exhibited at 1319 South Michigan avenue, with Sales Manager M. K. Cowan in charge. "We have enjoyed a very good business," he said, "and our policy of shipping carload lots to jobbers and dealers has met with great response. I have been very

pleased to accept the orders of a large number of merchants since the exhibition opened."

The Harponola Mfg. Co., with C. George Werner in charge, exhibited a complete line of their two products, the Chimonola and Harponola talking machine. The exhibit was held on the sixth floor at 1319 Michigan boulevard.

The Wartell Phonograph Co., with General Manager Wartell in charge, exhibited their complete line of "Wartrolas."

There was also a piano and talking machine concern represented in the Goldsmith Piano Co., of Chicago. Pianos, player-pianos and the Goldsmith Vocanola were on exhibition.

The Mandel Mfg. Co. held a very fine exhibit at 1411 Michigan boulevard, showing their complete line. W. C. Tyndall was in charge, assisted by H. H. Salzman. Mr. Tyndall reported the first few days of the exhibition as being highly satisfactory.

The Emerson Phonograph Co. exhibited at 1411 Michigan avenue, with C. J. Woodard in charge. Mr. Woodard was also very pleased with the attendance of merchants.

The Windsor Furniture Co. exhibited on the fifth floor of the building at 1411 Michigan avenue. G. M. Grace received visiting merchants. A complete Windsor line of cabinets and art period models were shown.

The Colonial Phonograph Co., of Sheboygan, Wis., exhibited their complete line at 1411 Michigan avenue. H. S. L. Allman was in charge.

The Playerphone Talking Machine Co. exhibited their complete line of instruments on the second floor at 1411 Michigan avenue. W. K. Cayton, sales representative, was in charge.

The World man picked up a clever little conversation on salesmanship at the Nightingale booth. "Now and then you will find a dealer so bent on selling a phonograph that he does not give his customers a chance to buy it. This is letting salesmanship run away with sense. The merchant who makes most of his money out of talking machines nowadays is the man

who has the happy faculty of looking at phonographs through his customers' eyes—of hearing them through his customers' love of music and sense of sound. When he demonstrates a fine instrument, he encourages his customers to forget their surroundings and imagine themselves listening to the song of a Nightingale in the old home."

A number of most interesting little paragraphs in the manner of the above are distributed throughout the book. The comparison between the appearance of the Nightingale talking machine and the brilliant plumage of the Nightingale bird is very ingenious.

TIMELY TIP ON A TIMELY TOPIC

By D. S. GILLESPIE

Of the Universal Stamping & Mfg Co.

What is a talking machine motor? Is it merely a mechanical part of the talking machine, whose purpose is merely to revolve a turn-table, or is it an integral part of the sound reproducing mechanism? I claim it is both, and if anyone cares to consider it in this light an agreement will easily be reached.

As everyone knows, the pitch of the sound produced by a talking machine can be raised or lowered by controlling the speed of the motor. This has long been known and anyone who has been in the talking machine game for a day or so soon finds it out.

The speed of the turn-table is controlled by a little set screw situated on the motor board. The set screw is numbered and a little arrow on the handle, when pointing to one of these numbers, indicates the number of turn-table revolutions per minute. In many of the high grade motors now on the market this controlling device is accurate and dependable; but in many others it is theoretical. It is practical in some instances and theoretical in others sim-

Relative Merit

In talking machines is not always determinable from outward appearances. Intrinsic merit goes deeper and is the subject of the following

Straight from the shoulder conversation

THE USONA

has demonstrated its merit through three years of successful selling. It is built by men of wide experience in the talking machine field and has always been backed by a policy of

BUILDING FOR THE FUTURE

which policy has necessitated the best obtainable in materials and workmanship.

Usona cabinets are exceptionally well constructed. The finish put upon even the smallest of our models is equal to that of a high-grade piano, hand-rubbed and finely finished. The motors are double-spring, smooth-running and powerful—of the highest type and as near trouble-proof as any mechanism can be made. The Usona tone arms and sound boxes represent the latest and best now being produced.

It will pay you to investigate

USONA TALKING MACHINE CO.
1977 Ogden Ave., Chicago

VALUE!

A remarkably well-constructed and reasonably priced machine designed to meet the demand for a model retailing at \$100.00.



47 inches
19 by 19 inches
Heineman
No. 33 Motor
Heineman
No. 11 Tone
Arm and No. 2
Sound Box

Model AX
Fumed Oak, Waxed
Oak and Mahogany
Finish

FROM OUR CHICAGO HEADQUARTERS—(Continued from page 113)

ply because, while one manufacturer adopts a policy of putting on the market a motor mathematically correct in every detail, another will turn them out without the slightest thought of mathematics. "Mathematics" is used in this sense in lieu of and representing precision.

A motor cannot be made to run anywhere near right if it is merely "assembled." It must be "built," and built by the company which makes each and every part that goes into its construction. In this way each little piece that goes into the motor is mathematically correct and measured to the ten thousandth of an inch. This is seen to by a competent engineer and the work is therefore dependable.

The parts, when put together, will therefore fit exactly, and a motor made in this manner will give perfect satisfaction. Noise will be eliminated and the speed will be constant.

The salesman who is demonstrating machines should know these things above all others, and the more he knows about the motor the easier it will be for him to convince his prospect that

the instrument he is offering for sale is of the best quality. He must know that rattling of the motor and variation of record speed will interfere with tone quality, for many a good sale has been lost on account of the salesman's ignorance in mechanical matters such as this.

Of course construction of cabinet enters largely into a sale but where the salesman can get a real music lover before a certain machine and demonstrate that this instrument emits the purest tone, free from any mechanical defects, such as mentioned above, he is doing more for the house he represents than he imagines, because a lover of music will always boost a pure-toned instrument. To the party who purchases an instrument for its furniture value, tone makes very little difference. Such a person buys the talking machine as a piece of furniture and regards it as such, whereas the music lover purchases it as a means of education and is generally broad-minded enough to boost it in trying to help educate others.

Therefore, if the talking machine salesman will remember that the talking machine motor is an integral part of the sound-reproducing mechanism and will impress this fact upon the mind of the music lover, he is sure to raise his stocks in the eyes of these people and in this manner greatly benefit himself.

BIG OKEH PACIFIC COAST TRADE

Communication From L. Gruen, Pacific Coast Branch Manager for Otto Heineman Phonograph Supply Co., Tells of Big Demand—Stradivaras Displayed at San Francisco Office

An idea of the splendid conditions of the talking machine business on the Pacific Coast was very forcefully manifested in a letter which was recently received by the Otto Heineman Phonograph Supply Co., Inc., 25 West Forty-fifth street, New York, from L. Gruen, Pacific Coast branch manager, who says:

"The demand for Heineman motors and records on the part of manufacturers and dealers on the Coast is growing so rapidly that the San Francisco office has been obliged to take more space and add to its office staff. The number of visitors is also increasing daily with the result that it has been found necessary to transfer to the factories numerous orders specifying delivery from stock.

"The jobbers are experiencing a call for Okeh records far beyond their anticipation, and consequently are clamoring for shipments in order to supply their dealers.

"The new addition to the San Francisco office is especially equipped as a service department, where all Heineman and Meisselbach motors, tone arms and sound boxes are inspected before being shipped to the customer. This department contains motors and parts mounted in various positions, and the manager, L. Gruen, is enabled to instruct mechanics and cabinet manufacturers how to install and adjust motors.

"A number of prominent cabinet makers have decided to make cabinets of California redwood veneered, in accordance with certain specifications which Mr. Gruen worked out in common with the California Redwood Association.

"The San Francisco office is exhibiting a full line of Stradivara phonographs manufactured by the Pacific Phonograph Mfg. Co., of Portland, Ore., and will soon also show Queen Anne tables containing Meisselbach outfits.

"This year promises to be a record-breaker, and the outlook is bright both for the manufacturer and the dealer. The San Francisco branch of the Heineman Industries has booked some of the largest contracts ever placed by Coast manufacturers."

Die Cast Tone Arms, Reproducers and Attachments in any Quantity

PARKER WHITE-METAL & MACHINE CO.
ERIE, PENNSYLVANIA

EMPIRE UNIVERSAL ATTACHMENTS

for
EDISON PHONOGRAPHS



Showing the attachment connected to Edison Tone Arm set in correct position to play Victor, Columbia, and any lateral cut record.

Write for
Descriptive Folder
and
Attractive
Quantity Prices



This shows the attachment in the proper position for playing the Pathé and any hill and dale cut record.

The Empire Phono Parts Co.

Sales Office

429 So. Wabash Avenue
CHICAGO, ILL.

Factory

CLEVELAND, OHIO

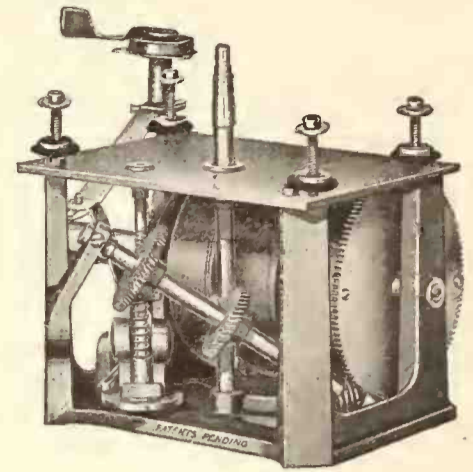
**Manufacturers**

Be advised that you cannot rightfully assert that your phonograph is "as good as can be made"

UNLESS

It is equipped with the new
Fulton Motor

(Designed by Wm. R. Everett, M.E.)

*This is the Noise-less,
Trouble-less, All Worm
and Spiral-gear
Motor. Cannot Be
Overwound.*

"No adjustments are provided
—none are necessary"

Send \$15.00 for sample
—refunded if motor is re-
turned. Price \$12.50 in
lots of 1000. Partial
shipments if desired.

Fulton Bros. Mfg. Co.

WAUKEGAN, ILL.

CHICAGO OFFICE:

20 E. Jackson Blvd.

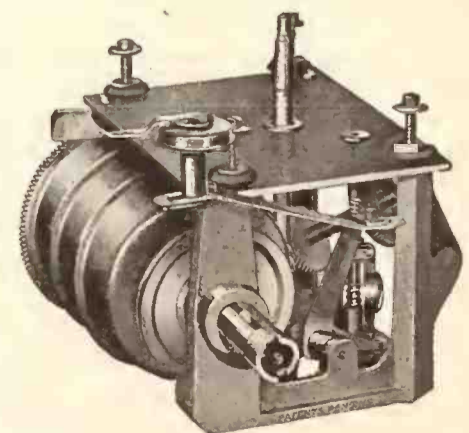

Our New Winner

MODEL NO. 3

In Walnut and Gold

Pictures cannot do justice to this beautiful cabinet.

Nearly every dealer who has seen the sample on display in our office, instantly ordered.

Here is a combination that wins admiration at a glance. We predict a large sale for every MANDEL dealer who displays this new Walnut and Gold phonograph.

All of the exposed metal parts are heavily gold-plated—the tone arm and reproducer, turn table frame, brake, hinges on doors and cover, lid support, winding crank, door knobs and all exposed screws.

The record compartment is lined with a beautiful green or brown silk plush.

The cabinet is finished in that distinctive MANDEL style—the kind our 3000 dealers are pleased to recommend. Great care is exercised in selecting beautifully grained Walnut lumber. The retail or list price is only \$150.00. It can't be surpassed if the price was \$100.00 more.

Order one and be convinced.

Write for details of our complete line of Mandel-made Machines

Mandel Manufacturing Co.

Incorporated

501 to 511 S. Laflin St.,

Chicago, Ill.



"NO PERCENTAGE IN ANNUAL CALF"

Some Timely Comments on Repeat Orders Found in the "Peptomist" for July

You have read of the town character who appeared before the Compulsory Work Bureau of his State Council of Defense with a vindication of his vagrancy that he "bought a cow now and then and gave it to a farmer who brought it up for its milk and gave him the annual calf as profit for the gift of the cow!"

This career, profession, what you will, occupied our friend's mind so fully he claimed recognition as a "worker."

What the Director thought of this workless, sweatless and probably payless job history does not say.

But we are reminded—

Did you ever know a salesman who turned over a good line of goods to a dealer with the understanding that the profits which came from the sale of the goods should go to the dealer, provided the "repeat order" came as profit to the salesman?

Did you ever run across any addenda in your reading of the history of "repeat order" salesmen?

A single "annual calf" does not make for a successful stock-breeding business, and an occasional repeat order does not make for success in any other line of business activity. Repeat orders must increase, expand, double. They must improve in quantity and quality, cover old fields and explore new ones.

There is no percentage in an annual calf.

There is no profit to you or your company in automatic repeat orders. They must be increased orders.

Selling a dealer is only half the job. You must work with him, trim his windows, educate his salesmen, investigate his stock, write his ads, develop his repair department, arrange his floor, suggest new sales letters, inaugurate sales plans, decorate his walls, introduce him to Columbia artists, instruct him in Grafonola

You ought to hear it!



Picture shows Sterling Reproducer in position for playing hill and dale record. Instantly turns to proper position for playing lateral record.

New Opportunity for Edison Dealers

Plays ALL records on Edison. Gets the BEST out of EVERY record.

The new Sterling Reproducer gets fuller, richer tone out of a Victor or Columbia record than you've ever heard—plays an Edison record with even improved beauty of tone and less rasp. It changes instantly from position for playing hill and dale records to position for playing lateral records. No extra elbows. Everything complete in one handsome durable reproducer and attachment.

Send for one at the dealers' price. Hear it and you'll want to sell it.

Fills a big demand. Order on your letterhead. Illustrated circular and price list gladly mailed on request.

STERLING DEVICES CO., Dept. 100, 467 East Ontario St., CHICAGO

Sterling Reproducer and Attachment

INCORPORATED

mechanism, teach him our catalog, interest him in music, and, after that, go into his problems and difficulties, satisfy complaints, make good mistakes, entice his employes, dig up prospects—in one word, work!!

Go to your dealer with the idea of selling him an order, naturally, but also go with the idea of selling him the idea of how to sell the order you sell him!

Do you catch on?

The Meuzo Chemical Co., Birmingham, Ala., has been incorporated with capital stock of \$50,000, by R. E. Seibels, R. G. Hudson and E. F. Hails. This firm will engage in the manufacture of a chemical which is used in connection with the making of talking machines and records, and is a new industry in the State of Alabama.

MORE POWER!

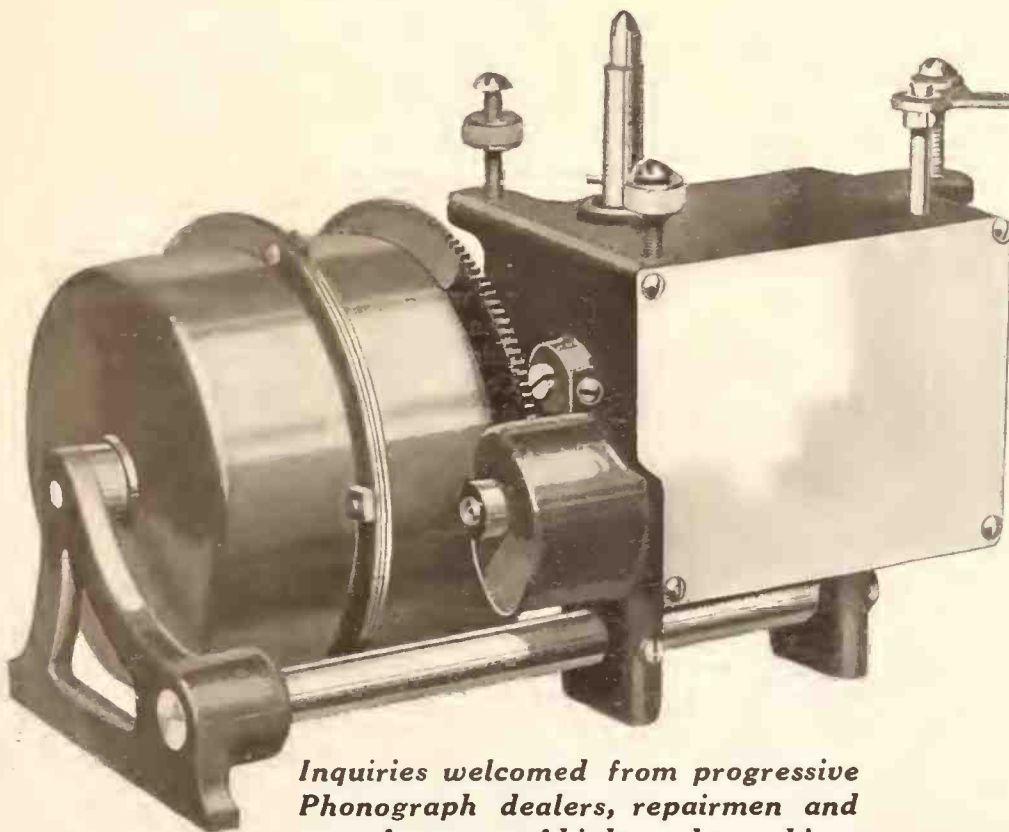

Inquiries welcomed from progressive Phonograph dealers, repairmen and manufacturers of high grade machines

**"IRONCLAD"
Enclosed MOTORS**

- "SILENT AS A SHADOW"
- ORIGINAL IN DESIGN
- ALL VITAL PARTS ENCASED IN A CAST IRON BOX
- ALL MOVING PARTS CONSTANTLY FLUSHED WITH OIL
- EXTRA HEAVY SPRINGS OF FINEST QUALITY DAMASCUS STEEL
- POWER APPLIED TO TURNTABLE SPINDLE BY A CLEVER NEW METHOD
- MADE IN SIX SIZES TO PLAY 4 TO 14 RECORDS
- THE "IRONCLAD" CAN BE HAD IN "THE MACHINE OF YOUR CHOICE."

**Make your friends glad with the "IRONCLAD"
—not a "kick" in a carload**

Chicago Recording Scale Co.

SALES OFFICE
108 WEST LAKE STREET
CHICAGO

Spring Motor Makers for Over Thirty Years



The Best Talking Machine Needle on the Market

PACKED IN COUNTER SALESMEN

50 Needles to a box and they retail at 10 cents per box.
60 boxes to a package, \$6.00. This package costs you \$3.90 net.
Your profit is \$2.10 and your customer gets a needle that will give satisfaction.

THE FRED. GRETSCH MANUFACTURING COMPANY

60 Broadway *Manufacturers of Musical Instruments* BROOKLYN, N. Y.
Canadian Wholesale Agent, H. A. BEMISTER, 10 Victoria Street, Montreal, Can.
Western Distributor: WALTER S. GRAY, 530 Chronicle Building, San Francisco, Cal.

SHAFFER, KREMER & CO. TO OPEN

New Lockhaven Store Will Open About the End of July—F. J. Vierra to Be Manager

According to an announcement received from Lockhaven, Pa., the Music Shop, under the direction of Ellis B. Shaffer and Oscar P. Kremer, will open during the latter part of July, under the firm name of Shaffer, Kremer & Co. The new store will be managed by Frank J. Vierra, a well-known musician of that city, and a bandmaster of considerable reputation. The new Music Shop will be refinished in a most modern way, and a number of sound-proof booths will be installed. In addition to

the line of Edison and Columbia machines and records a large stock of musical merchandise will also be carried.

CONDUCTING THREE LIVE STORES

PHILADELPHIA, PA., July 7.—Julius Burnstine is at present handling very successfully a full line of talking machines and pianos at his main store, 127 North Tenth street, this city, and also at his branch stores, 25 Lafayette street, Riverside, N. J., and 411 Cooper street, Beverly, N. J. Mr. Burnstine takes personal charge of ordering for his main and branch stores, and all orders for stock are placed through the Philadelphia office.

"MICKEY" REACHES PHILADELPHIA

City Gay With Unique Displays—Columbia Co. Wins Highest Honors With Its Big Float Featuring a Twelve-Foot Record.

PHILADELPHIA, PA., July 7.—The famous "Mickey" film has at last reached this city and

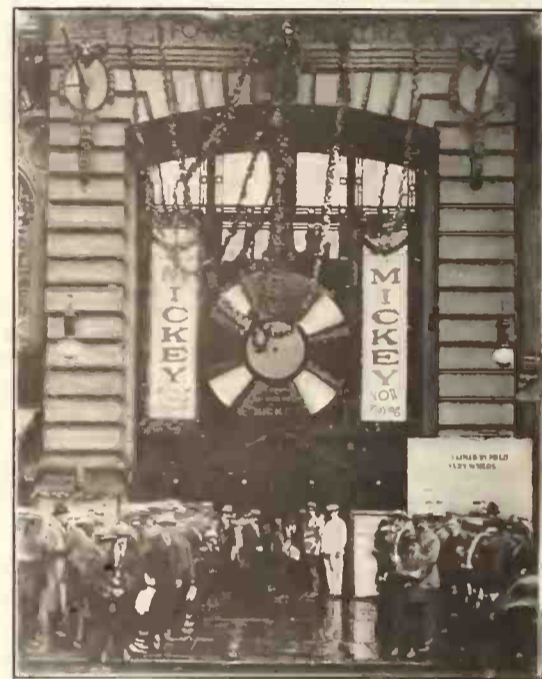

How "Mickey" Scored in Quaker City the local dealers staged one of the best advertising campaigns yet held. Manager Wilcox, of the Columbia Co., had made a twelve-foot model of a record and mounted it on a motor truck which toured the city and attracted much attention. On the truck was a girl dressed like the heroine of the story and the huge crowds which everywhere followed the display showed that it was a big success. The mammoth record was placed over the entrance of the Forrest Theatre, where it remained as a constant reminder to the crowds attending the performances of the film. The individual window displays throughout the city numbered forty-two, showing that the dealers were awake to the possibilities of the occasion. Much credit for the success of the campaign is due J. D. Westervelt, of the Columbia Co., who spared no pains to make the celebration the biggest ever held in this city.

The O. K. Houck Piano Co., Little Rock, Ark., believing that sales are stimulated by regularly reviewing record sales, issues a list from time to time of the six best sellers in the record field. This has proven a very satisfactory business move.



Attention
Victor
Dealers

Order
Through
Your
Distributor

it wraps the records and sells 'em too!

ON the first day of Every Month you are provided with a NEW stock of delivery envelopes, sufficient to wrap all the new records received that month—

ATTRACTIVELY printed with timely designs, prominently displaying the—

BIG HITS you are right now offering for sale and further—
A selected list of records appropriate to the month; for example, the July list showed Patriotic Numbers.

BEST of all—YOUR Name on every envelope.
AND THE PRICE INCLUDING your name

\$1.50 per 100 for 10" size
\$2.00 per 100 for 12" size

DON'T wait—order through your distributor, or write direct to us, naming your distributor.

LU-FRANC SALES SERVICE CO.

45 Washington Blvd.

DETROIT

DECALCOMANIA

Name Plates for Talking Machines, Pianos, etc.
High Class Workmanship
Write us for further information
National Decalcomania Co.
220-230 N. 60th St., Philadelphia, Pa.

The Instrumentized, All-Record Player



A Better Phonograph with a Better Selling Plan

“Nationalized for Wholesalers” and You

THE discovery that the nationally advertised trademark could be used, has been abused. The nationalized trademark of the Dalion will never be used to cut out the wholesaler! It will be used for their benefit—and yours.

Suppose, Mr. Retailer, that all your stock had to come by long distance shipment from factories—what big money you would be compelled to tie up in reserve stock. Let nearby wholesalers carry the reserve—do your business on small shipment turnover.

For self-interest, support your wholesalers, who deserve it because of modern merchandising methods. It's your protection against arbitrary dictation, as well as an assurance of service.

THE Dalion wholesaler steps out with a new standard of service—factory trained men to give you co-operation and show you the Merchandising Methods which bring success. Your Dalion wholesaler carries a big reserve stock—maintains a service department—is practically a factory branch.

—and behind the wholesaler, directly co-operating with you, is the Dalion factory promotion organization. We will back our belief in your success dollar for dollar with you. The details of our retail merchandising plan will prove it. Write for it.

The biggest unit of sale ever possible in almost every home—the greatest money-profit per sale—that's the phonograph business!

Are you interested in it on the basis of an extraordinarily attractive, exclusive agency proposition? Write for details—for figures as to your reasonably possible profits.

Why Dalion Sells Better

THE Auto-File—exclusive with the Dalion. Not only is it the neatest and most compact of record filing devices, but it makes it totally impossible to misfile or misplace records no matter how hurried you may be. By a marvelously simple and ingenious device every record must go back to its individual compartment before another can be taken out.

Instrumentized Tone Throat. The triumph of the Dalion, embodying the scientific principles of instrument acoustics, applied through the deft skill of hand workers. Their careful, individual shaping of the long-seasoned wood is not factory work but the proudfest touch of the real instrument maker.

Orchestra-Shell Tone Chamber. All-wood sounding chamber, shaped as scientifically as an orchestra shell, the Dalion gets its wonderful resonance and clarity.

Motors. Two- and three-spring, according to size of instrument. Long-running, easy-winding and guaranteed against spring breakage.

Milwaukee Talking Machine Mfg. Co., Milwaukee

Prices \$97.50 to \$300.00



MILWAUKEE DEALERS EXPECT PROHIBITION TO AID TRADE

Look for Music to Supplant Alcohol as a Stimulant—Business Continues to Maintain High Level—Factories Increasing Productive Facilities to Meet Demands—General News

MILWAUKEE, Wis., July 11.—Looking back over the first six months of 1919, or even back to the day when the war came to an end just eight months ago, the talking machine trade of Milwaukee feels as if it has been in a dream of bountiful goodness. Almost without exception dealers declare this period to have been the most wonderful in their entire experience. What is more, there does not appear to be the slightest reason to fear that this remarkable stimulation will suffer a decline for some time to come.

The transition of the United States to a boneyard State on July 1 is expected to prove of great benefit to the talking machine and other music industries and form one of the most powerful influences to sustain the present brisk demand for instruments of all kinds, especially the talking machine. It is considered that there is nothing so peculiarly adapted to supplant what is taken away by prohibition as music—good music. There is no single musical instrument that is capable of reproducing every other kind of instrument, alone or collectively, as the talking machine.

It is with this belief in mind that the talking machine manufacturing industry of Milwaukee and Wisconsin is doing its utmost to extend the productive facilities to meet the present overwhelming demand, as well as the greater requirements to come next fall and during the holiday season. As a talking machine-producing State Wisconsin now ranks among the largest in the country and at the present rate of solid, substantial expansion it will probably improve this rank by the end of this year.

The Recordeon Phonograph Corp., Milwaukee, with a capital stock of \$100,000, has been founded by Edward A. Heaney and Walter H. Schwab, who last December established the General Mfg. Corp. The General Co. is operating in the for-

mer factory of the Minn Billiard Co. and the owners have also acquired the plant of the American Auto Body Co. at North Milwaukee. The North Milwaukee property will be operated as the Recordeon Corp. Mr. Heaney formerly was president of the Milwaukee Talking Machine Mfg. Co.

The Multitone Mfg. Co., Eau Claire, Wis., has purchased the Eau Claire Trunk Co. plant and will use its present leased factory for cabinet work and the new main plant for other processes. The capacity will be 100 instruments a day within a month's time. E. J. Sailstad is president and general manager.

The E. H. Stafford Mfg. Co., McClurg Building, Chicago, has purchased the Caloric Co., Janesville, Wis., manufacturing fireless cookers and talking machine cabinets. The business will be continued as the Stafford-Caloric Co. and the plant devoted largely to cabinet production for the talking machine industry. The Stafford Co. also operates large plants at Paxton, Ill., and Ionia, Mich.

The F. Eggers Veneer & Seating Co., Two Rivers, Wis., which is widely known in the industry for its fine veneers and panels, is making a \$125,000 factory addition, to be ready about August 15 or September 1. The additional facilities are needed largely because of the enormous growth of demands from the talking machine cabinet trade.

Milwaukee instrument manufacturers are participating in a campaign undertaken by the Milwaukee Association of Commerce to promote export trade on a much greater scale than before the war.

Milwaukee wholesalers and jobbers in talking machines say they are still suffering from an acute shortage of goods, but that there is every prospect of betterment in the supply during the coming months. According to Harry A.

Goldsmith, secretary of the Badger Talking Machine Co., 135 Second street, Victor jobber in Wisconsin and Upper Michigan, the demands from its customers in the last six months were relatively enormous and are still being kept at a high level by the unusual interest in the Victor.

The Columbia was the official instrument on this year's trade promotion trip of the jobbers' division of the Milwaukee Association of Commerce, as it was on every one of the preceding seventeen excursions so far held. A party of 100 local jobbers, traveling in a special train, spent a week in covering 1,000 miles of Wisconsin to the tune of the Grafonola, which was furnished, as usual, by A. G. Kunde, distributor of the Columbia, with headquarters at 516 Grand avenue.

The splendid representation which is being given the Sonora phonograph in the Wisconsin and northern Michigan territory by the Yahr & Lange Drug Co., jobbers, Milwaukee, is a constant subject of comment in the local trade. The Milwaukee wholesale house has occupied an advantageous position in being able to make prompt deliveries and this has made for it and its line many fast friends among retailers.

Sales of the Brunswick phonograph in the territory handled by the Milwaukee branch of the Brunswick-Balke-Collender Co. broke all records for a half-year period during the last six months. Manager Thomas I. Kidd expresses himself as immeasurably pleased with the manner in which the Brunswick is extending its acquaintance in Wisconsin and he graciously attributes this largely to the fine dealer organization which has been built up in the last two or three years and now embracing some of the largest and most prominent retail stores in Wisconsin and vicinity.

The demand for the New Edison has been far and away beyond anything that has ever been experienced and shows not the least sign of a let-up, according to the Phonograph Co. of Wisconsin. It has been an extremely difficult matter to keep deliveries commensurate

Makers of High-Grade Phonographs | Billiard and Pool Tables. Est. 1882 |

Our Phonographs Play All Records Correctly

Number One
DIMENSIONS: 17" high, 21" long, 10" wide.
CASE WOODS—Mahogany finish—quarter-crowned oak, turned finish.
NOTES—Double spring, worm gear 12 inch turn table. Tone modifier. Speed control and hand motor.

Number Three
DIMENSIONS: 31" high, 20" long, 22" wide.
CASE WOODS—Genuine mahogany or quarter-crowned oak, turned finish. Genuine hand-carved legs. Carved grill.
NOTES—High grade, worm gear motor. Micrometer adjusted. Tone modifier. 12 inch turn table. Automatic stop. Speed control and brake. Piano hinge.

Number Five
DIMENSIONS: 51" high, 20" long, 22" wide.
CASE WOODS—Choice figured mahogany or selected quarter-crowned oak, turned finish—genuine hand-carved legs. Carved grill, richly ornamental.
NOTES—Very best worm gear motor. Micrometer adjusted. Tone modifier. 12 inch turn table. Automatic stop, speed control and brake. Piano hinge. Lock and key. All metal parts heavily gold plated.

Number Four
DIMENSIONS: 50" high, 22" long, 22" wide.
CASE WOODS—Genuine mahogany or quarter-crowned oak, turned finish.
NOTES—High grade, double spring, worm gear. Micrometer adjusted motor. Tone modifier. 12 inch turn table. Automatic stop. Speed control and brake. Piano hinge.

Number Two
CASE WOODS—Genuine mahogany or quarter-crowned oak.
NOTES—High grade, double spring, worm gear. Micrometer adjusted motor. Tone modifier. 12 inch turn table. Automatic stop. Speed control and brake. Piano hinge.

HIGH QUALITY AT LOW PRICES MAKES US LEADERS IN PHONOGRAPH LINE

The quality of our Cabinet Work, the low price and our long experience in making phonographs places us among the foremost leaders in this industry. We have built a big clientele of satisfied customers throuthout the country, and with our knowledge and facilities insure you prompt service.

THE BIGGEST JOBBERS COME TO US.

We are making machines under various names for the largest jobbers in America. We will do the same for you—Write us.

FOREMOST RETAILERS BUY THRU OUR JOBBERS.

We have a jobber in your territory who can keep you supplied with the best line of phonographs at the price made in America, on which you will make a good reasonable profit—Write us.

Also furnish selling helps, such as sales letters, folders, pamphlets, etc. (Have just tripled our capacity by acquiring large factories at North Milwaukee)

RECORDEON PHONOGRAPH CO.
NORTH MILWAUKEE, U. S. A.

GENERAL MANUFACTURING CORPORATION
MILWAUKEE, U. S. A.

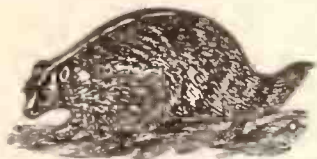

PERSONAL SERVICE

The members of our Company are always available and will gladly see you personally or write you at any time we can possibly serve you.

Why not communicate at once with us?

EXCLUSIVELY WHOLESALE

BADGER TALKING-MACHINE CO. 135 Second Street
MILWAUKEE, WIS.
VICTOR DISTRIBUTORS

with orders, but by dint of great effort Manager W. A. Schmidt has been able to satisfy not only dealers, but their patrons as well, giving the New Edison unusual prestige in this field.

Pathé dealers here and throughout Wisconsin have been favored with a remarkably good business during the last few weeks.

The Jackson Piano Co., manufacturer of pianos in this city, on July 1 opened a retail store at 425 Milwaukee street, which handles the Columbia line in addition to its own products and the Kurtzmann pianos.

Col. Peter F. Piasecki, in private life Victor dealer, at 441 Mitchell street, Milwaukee, has returned from foreign service after an absence

of nearly two years. During his absence the business was ably conducted by Mrs. Piasecki, who earned a reputation as one of the best and most successful women dealers in the local trade. Col. Piasecki was commander of the 107th sanitary train and military police, Thirty-second Division.

C. C. Warner, Victor dealer in this city, has recently improved and enlarged his store by remodeling the building to embrace an adjoining store.

Alfred W. Fuchs, 1403 Green Bay avenue, who carries the Brunswick, Sonora and Columbia in his jewelry store, recently celebrated his silver wedding anniversary.

Leslie C. Parker, president and general manager of the Badger Talking Machine Shop, Victor retailer, described the Victor industry before a recent weekly luncheon of the Kiwanis Club and surprised the members with an array of interesting facts and statistics concerning this great interest and its equally great product. Mr. Parker told the Kiwanians that people in Milwaukee spend more than \$650,000 a year in purchase of Victor instruments, records, needles, etc.

The J. B. Bradford Piano Co., a large retailer of the Victor and Sonora, on June 25 put into effect a strict one-price policy throughout its organization, being the first music concern in Milwaukee to adopt this plan. The one-price policy is one of many progressive merchandising plans introduced by Hugh W. Randall since becoming president and general manager of the company a year ago.

Miss Julia Wolff, manager of the Aeolian-Vocalion department of the Edmund Gram Music House, will soon have greatly increased facilities to accommodate the rapid growth of this phase of the business. Plans are being made for remodeling part of the main floor to provide more display and demonstrating booths and full-fledged counters for the sale of records and music rolls.

COLLINGS WITH PRICE T. M. CO.

Head of Trade Service Department of Victor Co. Resigns to Enter Wholesale Field in Newark, N. J., as General Manager of the Price Talking Machine Co.—Name of Concern to be Changed to Collings & Price Co.

L. W. Collings, for the past twenty years connected with the Victor Talking Machine Co., for a large part of that time as manager of the trade service department of that company, has resigned to become connected with the Price Talking Machine Co., Victor wholesalers in Newark, N. J., as general manager.

When Mr. Collings becomes officially con-

nected with the Price Co., on or about August 1, the name will be changed to the Collings & Price Co., with Malcolm G. Price as president. New and larger quarters, modernly equipped, will be provided for the company in Newark and the territory covered will be extended to embrace northeastern Pennsylvania, including the rich coal districts and such cities as Scranton and Wilkesbarre, as well as northern New Jersey.

Mr. Collings' long and successful experience in the matter of providing service to the trade for the Victor Co. will stand him in good stead in his work of carrying out the ambitious plans being made for the new Collings & Price Co. in the matter of taking care of dealers' require-

ments in a big way and giving them the service that goes with the goods and a little more to spare.

A further and more complete announcement of the plans for the new Collings & Price Co. will be made very shortly and it is expected to be distinctly interesting.

OPEN NEW ESTABLISHMENT

A new talking machine store has been opened in St. Peter, Minn., by S. I. Snortum. This firm will handle the Victor line of talking machines and records. The establishment will be handsomely equipped with sound-proof booths and other essentials.

THE LAST WORD IN TONE REPRODUCTION

Achieved by men who have made
a Life Study of Musical Sound.

The
BUSH & LANE
PHONOGRAPH
*is a Perfect Musical
Instrument*



BUSH & LANE PIANO CO.
HOLLAND, MICH.

The Widdicomb
A FINISHED
PRODUCT

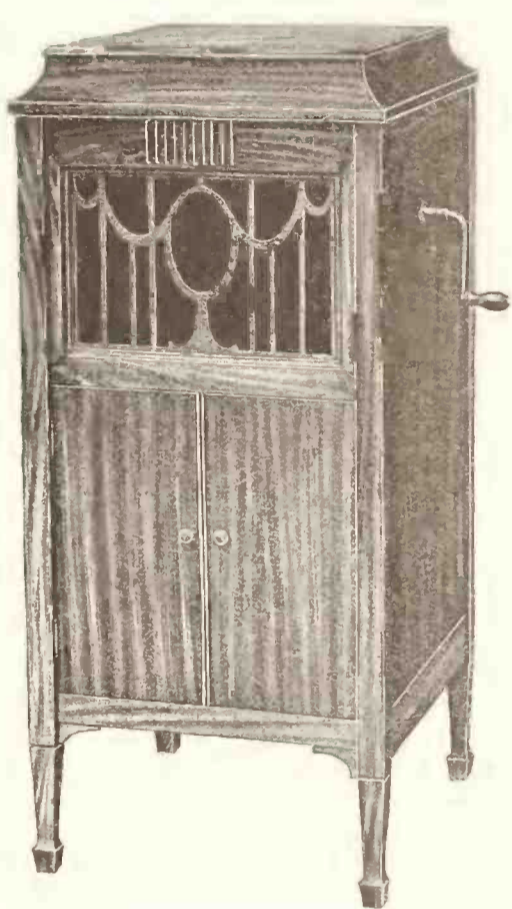

WIDDICOMB No. 10
Adam

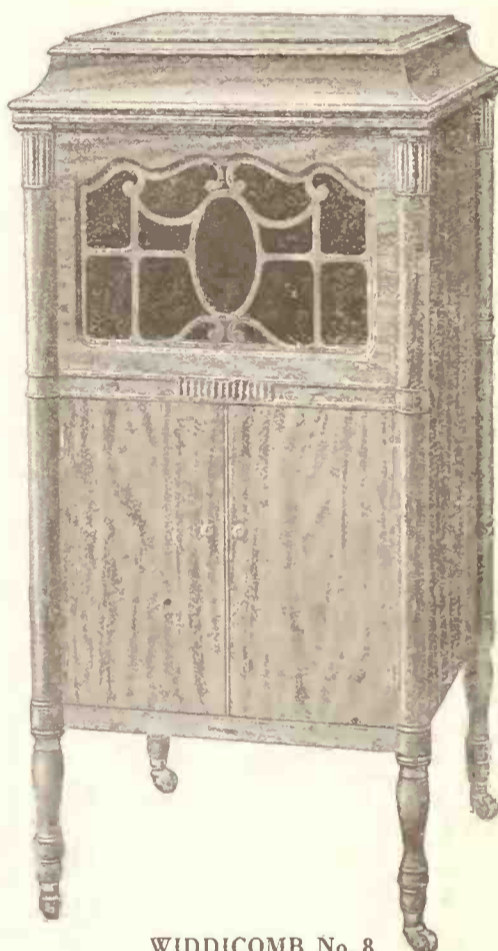

WIDDICOMB No. 8
Colonial Adam



WIDDICOMB No. 6
Queen Anne

Eleven Period Designs
to Select From

Manufactured by
PHONOGRAPH DIVISION
THE WIDDICOMB FURNITURE CO.
GRAND RAPIDS, MICHIGAN

NOW MAKING OKEH RECORDS

Captain Pat Conway's Band Now Recording for Otto Heineman Phonograph Supply Co., Inc.—One of the Foremost Bands in the Country

The Otto Heineman Phonograph Supply Co., Inc., announced this week that Captain Patrick Conway and his famous band are now making records for the OkeH record library. A series of records by this well-known band are now in preparation and will be ready for the trade within the next few weeks.

Capt. Conway is one of the foremost band directors in the country, and Conway's Band has appeared in practically every city of importance. It has won the enthusiastic commendation of music lovers everywhere, and when it appeared a few years ago at the Panama-Pacific Exposition it proved to be one of the most successful features of this Exposition.

Capt. Conway rendered invaluable service to the Aviation Corps of the United States Army during the past war as a bandmaster, and in recognition of this service he was recently ap-

pointed a Captain in the Aviation Corps. At the present time Conway's Band, with Captain Conway conducting, is filling a season's engage-



Capt. Pat Conway

ment at the Steel Pier at Atlantic City, where it will be heard by hundreds of thousands of visitors to this famous pleasure resort.

SOUTHERN DEALERS TO ORGANIZE

Elyea Co. Send Out Call for Meeting of Victor Dealers in Atlanta on July 16 for Purpose of Forming An Association of Dealers

On Wednesday, July 16, Southern Victor dealers are planning to meet in Atlanta for the purpose of forming a Southern Victor Dealers' Association. A recent circular mailed out by the Elyea Co., Victor wholesalers located in Atlanta, reads in part:

"Mark July 16 on your calendar. That's the day Southern Victor dealers will meet in Atlanta for the purpose of forming a Victor Dealers' Association.

"This meeting is now an assured fact. More than fifty of our best dealers have promised to come and we expect more than a hundred to be on hand. Will have good speeches, good entertainment, good time.

"A definite program will be sent you not later than July 12. But this much we can promise, a speaker from the Victor Co. and from the Talking Machine World will certainly be on hand to address you. You simply cannot afford to miss it. If you haven't already advised us that you are going to be on hand, do so at once. Get your name in the pot."

HAS ATTRACTED WIDE INTEREST

Demand for the Modernola Is Steadily Expanding—Shipments Made From New Plant

That the Modernola, the new circular instrument with the lamp shade feature, has attracted the attention and interest of dealers everywhere is evidenced by the inquiries being received by the manufacturers.

Shipments are now being made from the new plant at Johnstown, Pa., to all parts of the United States. The responses of American dealers to announcements made through the Talking Machine World have been such that operations for the present will not be extended into export business.

The rate at which orders are being received justifies the management in its belief that present output capacity will be needed for filling domestic requirements.

H. L. Moorey, manager of the New Haven branch of the Columbia Graphophone Co., spent a few days recently in New York.

Write for our catalogues on phonograph hardware, motors, tone arms, records and accessories.
 HIGHEST QUALITY LOWEST PRICES
COLE & DUNAS MUSIC CO.
 54 W. LAKE STREET CHICAGO

Cabinets to fit Your Special Needs



Phonograph cabinet building is our specialty. We make cabinets to suit your sales proposition.

You can develop a big phonograph business with a minimum manufacturing investment by specifying Singer Cabinets.

Carefully selected, well seasoned stock, expert cabinet making, resonant tone chamber, pleasing designs and finish—these features account for Singer demand. We give you maximum quality for the price.

Send us your specifications and we will show you why we should be your factory.

Singer Talking Machine Co.
 Milwaukee, Wis.

This Trade-Mark

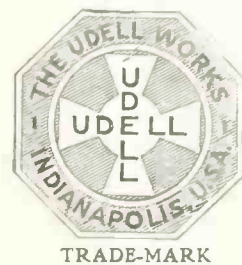

On a record or music roll cabinet is a guarantee to the dealer and his customer that the hidden details of the cabinet are right.

When the type of cabinet and its design attract and the finish pleases—all apparent on the surface—

The UDELL Trade-Mark

offers the clinching argument—the recognized proof of quality and honesty in workmanship.

Dealers who handle UDELL CABINETS never have to apologize.

The Udell Works

1205 Twenty-eighth St.

Indianapolis, :: :: Ind.



Thousands will see Nazimova's new motion-picture film "The Red Lantern." Thousands will dance to its medley fox-trot of the same name. A-2747.

Columbia Graphophone Co.
NEW YORK

PROSPERITY IN PITTSBURGH HELPS "TALKER" INDUSTRY

Sales Are Active and Dealers Are Placing Orders for Fall—Important Association Meeting—H. M. Swartz Promoted—Stock Shortage Still Complained Of—Demand for the Brunswick

PITTSBURGH, PA., July 3.—One of the most hopeful signs on the horizon of the talking machine trade in the Pittsburgh district is the fact that the reconstruction plans in industry are having a tremendous influence in the iron and steel trade with the corresponding result that the operation of the mills is assured for many months to come. This also means that the high wage rate that has been in force for so long a time will continue. With plenty of work and high wages the fact is patent that many of the thousands of dollars put into circulation every pay-disbursing day will find their way into the coffers of the Pittsburgh merchants, and, of course, the talking machine dealers will also reap part of the harvest.

Trade in the talking machine industry here the past month has been good. Sales of talking machines have been steady, while records, especially those of a popular nature, have had tremendous sales. This is especially true of the Victor, Columbia, Emerson, Pathé, Edison and OkeH records, hundreds of which have been disposed of during June.

The value of the Victrola in welfare work was emphasized at a conference of welfare and social workers of the various welfare departments maintained by the Carnegie Steel Co.,

which was held at Munhall, Pa., Saturday, June 28, by Miss Lillian A. Wood, manager of the Victor educational department of the C. C. Mellor Co., Victor distributors. Miss Wood has had unusual success in presenting the merits and advantages of the Victrola and Victor records in the public school room.

The annual outing of the Talking Machine Dealers' Association of Pittsburgh, which marked the closing meeting of the season, was held at "The Pine," a suburban resort, on Tuesday evening, June 17, with over a hundred enthusiastic talking machine dealers in attendance. Charles L. Hamilton, president of the association, presided. Two new firms were admitted to membership, the Rudolph Wurlitzer Co., Victor dealer, and the Lohmeyer Pharmacy, Columbia dealer. J. C. Roush, president of the Standard Talking Machine Co., made reference to the legal decision in the celebrated Colgate case by the Supreme Court and its bearing on the talking machine industry. The dinner was the main event of the evening and everybody had a good time. There was music, both instrumental and vocal, Fred Newman, of the W. F. Frederick Co., enlivening the occasion with a number of songs. The committee in charge of the affair consisted of John

Henk, chairman; J. H. Phillips, J. E. McCormick, Clark Wright and Leo Half. No meetings of the association will be held until fall, when Secretary A. R. Meyer will send out formal notices of the initial session.

S. H. Nichols, the able manager of the Pittsburgh offices of the Columbia Graphophone Co., reported a brisk trade during June and stated that the amount of business done was far ahead of the same period a year ago. Mr. Nichols pointed out that the demand for Columbia Grafonolas and Columbia records was most pronounced and that the various Columbia retail dealers all reported increased sales during the month just ended.

Harry M. Swartz, for the past two years in the employ of the Buehn Phonograph Co., has been appointed assistant manager by the directors. Both Mr. Buehn and Mr. Swartz have their offices in the new wholesale department of the company, which is now located in the Stevenson and Foster Building, on Seventh avenue, immediately adjoining the Chamber of Commerce Building. Fully 10,000 feet of floor space is provided in the new wholesale department for the sale and display of Edison phonographs and Edison records. The retail Edison department is still located at 513 Wood street, in charge of Mark M. Mitchell, whose attractive window displays featuring the Edison phonograph are both original and novel.

T. T. Evans, assistant manager of the wholesale Victrola department of the C. C. Mellor Co., is back on the job again, after having served Uncle Sam in the army overseas. He is being given a hearty welcome by the trade as he again resumes his visits. John Fischer, the manager of the department, after attending the Victor Jobbers' meeting at Atlantic City, took Mrs. Fischer and Junior Fischer, their son, and hied away to the wilds of Canada, where they will spend July. The Mellor Co. was also represented at Atlantic City by General Manager W. C. Dierks and Mr. Evans. P. W. Simon, the Victor Shop man of Uniontown, Pa., accompanied the Mellor delegation to the shore.

J. C. Roush, president of the Standard Talking Machine Co.: French Nestor and Wallace Russell were the Standard Co. representatives at Atlantic City.

The W. F. Frederick Piano Co. utilized a novel publicity method in calling attention of the vacation contingent to the advantages of the Victrola as an essential in summer outings and picnics. George H. Rewbridge, manager

ESTABLISHED 1831

In the Music Business
Continuously for 88 Years

Our Age the Best Evidence that We
Render Satisfactory Service

Mellor's
604 Wood St.

Victrola Wholesalers

PITTSBURGH, PA.

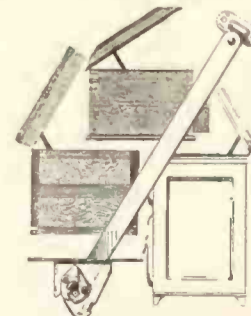

**New Automatic
Cover Support**

Practical—Inexpensive
Holds Cover at any angle
Fool Proof

Samples on Request
Quantity Discount

Automatic Cover Support Mfg. Co.
54 Jones St. Newark, N. J.

BEST QUALITY LOWEST PRICES

RECORD DELIVERY ENVELOPES

PLAIN PRINTED

1331-33-35 FIFTH AVE. **The ALDINE CO.** PITTSBURGH, PA.

of the wholesale Victor department of the Frederick Co., reported business as good and the demand strong. Mr. Rewbridge attended the Victor convention at Atlantic City.

H. Milton Miller, manager of the Pittsburgh offices of Smith-Kline-French Co., Sonora phonograph distributors, stated that the only handicap to a rushing business was the inability at present to supply all of the various styles of Sonora that are in demand. Earl S. Miller is the new roadman for the Pittsburgh office and is now visiting the various Sonora dealers in the Pittsburgh territory. The Pittsburgh office is also a distributing center for the celebrated OkeH records, which are having a brisk sale.

H. J. Brennan, manager of the Pittsburgh Pathéphone Co., stated that he was preparing for a big rush for Pathe phonographs and records this fall.

H. C. Niles, secretary-treasurer of the Starr Phonograph Co. of Pennsylvania, stated that the demand for Starr Phonographs and Gennett records was good and that the retail dealers all reported trade as very brisk.

"The Cheney phonograph has made many friends in Pittsburgh and vicinity and we are more than pleased with the amount of business we are doing," said Manager Close of the Dauler-Close Furniture Co.

J. A. Andres, sales manager for the Pittsburgh district of the Brunswick phonograph, spent part of the past week in the territory north of Pittsburgh, calling on the Brunswick dealers. He states that the prospects are very bright for a successful fall season. It is intimated that the fall season will see the introduction of the Brunswick records on the market and it is predicted that the combination of the Brunswick phonograph and Brunswick record will be a tremendous selling card for the retail trade. It was stated that in order to care for the large increase in the Brunswick phonograph trade two additional floors had to be leased, which will be used exclusively for the display and demonstration of the Brunswick phonograph. The two floors are in the building immediately adjoining the present location of the Brunswick-Balke-Collender Co., Wood street and First avenue.

The demand here for the Emerson records continues quite strong, according to Jacob Hirsh, of the Emerson Sales Co., wholesale distributors of the Emerson records. He stated that shipments of records now coming in are giving the office an opportunity to fill up their back-record lists. He anticipates a real rush for Emerson records this fall. Mr. Hirsh was a visitor to the Emerson offices in New York last week.

The National Phonograph Co., a new Pitts-

burgh organization, who are manufacturing and distributing the Ultraphone, have opened a retail Ultraphone Shop in the Jenkins Arcade, with entrance from the Arcade and also from 518 Penn avenue. H. E. Fleishman, general manager of the company, stated that the Ultraphone advance orders were quite flattering.

Leo Half, of Half Bros., the Victor, Edison and Columbia dealers, of Homestead, Pa., stated to The Talking Machine World representative that the sales of Victor, Edison and Columbia records were keeping up at a swift pace, notwithstanding the warm weather. Half Bros. are well known to the trade and have a very fine talking machine department.

A. R. Meyer, manager of the Joseph Hornc talking machine department, reports a splendid movement of Victrolas and Columbia Grafonolas.

The new manager of the Kaufmann & Baer Co. talking machine department is Hartley J. Pierce, who spent thirteen months in the merchant marine service during the war. He was connected with the Columbia department of May, Stern & Co. when he enlisted. The Kaufmann & Baer Co. handle the Victrola, Columbia and Aeolian-Vocalion machines.

CONTRIBUTE TO MUSIC MERCHANTS

Talking Machine Men, Inc., Send Fifty-dollar Contribution to National Association

A check for \$50, signed by Treasurer A. Galuchie, of Talking Machine Men, Inc., has been forwarded by Secretary E. G. Brown to the National Association of Music Merchants. In forwarding the check to C. L. Dennis, secretary of the National Association, Mr. Brown stated its purpose as follows:

"Enclosed herewith you will please find our check for fifty (\$50) dollars, amount of our contribution for 1919 to the National Association of Music Merchants, and as an evidence of our desire to assist the Bureau for the Advancement of Music."

The tri-state organization of talking machine men of New York, New Jersey and Connecticut is one of the live-wire associations in the retail

The Bell Hood

Pat. Sept. 24, 1912

Semi-Permanent Point Needle

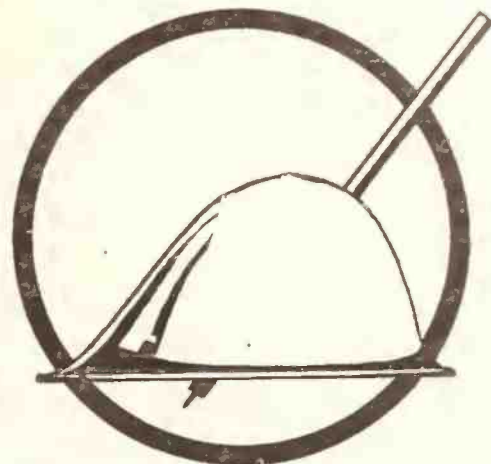

The Sounding Board Bell Produces the Best Result

Advantages of the Bell Hood Needle

Plays 50 to 100 Records—Eliminates Scratching—Purifies and Humanizes the Tone.

Retails one package of 3 Needles for 25 cents

Dealers' Prices, \$15.00 for 100 Packages

The following are some of the distributors of the Bell Hood Semi-Permanent Point Needle:

- New York City
- Winterrath & Co. (in all their seven stores).
- Union Talking Machine Co., Ave. B and Second St.
- Charmophone Co.
- European Phonograph Co., 170 Ave. A.
- James Cavalaro, 5 East 14th St.
- J. Klein, 28th St. and Second Ave.

- B. E. Peebles, Adams, Mass.
- J. Blum, New Brunswick, N. J.
- Ph. Prayder, Inc., New Rochelle, N. Y.
- Geo. Cook, Ticonderoga, N. Y.
- Newark Music Shop, Newark, N. J.
- Behrend's Music Store, Newark, N. J.

Representative for Dominion of Canada

ARTHUR K. KEMPTON

Suite 205, Drummond Bldg., Montreal, Quebec

New England Musical Instrument Trading Co.

127 East 23rd St., New York

Exclusive World Distributors
PHILIP JACOBSON, Prop.

trade. Its recent affiliation with the national work, through application and acceptance at the recent Chicago conventions, was the first step toward organized recognition by phonograph dealers of the work being done for the advancement of music.

Talking Machine CABINETS

TO THE TRADE

All Styles Made to Order
Lowest Net Prices

Manufacturers Sales Co.
NORRISTOWN, PA.

SPECIAL OFFERS

RECORD DELIVERY ENVELOPES

45-lb. Kraft, 2 Buttons, String Fasteners

1-M QUANTITY
10-in.—\$ 9.25 per thousand
12-in.— 11.00 " "

5-M QUANTITY
10-in.—\$ 8.75 per thousand
12-in.— 10.50 " "

10-M QUANTITY
10-in.—\$ 8.25 per thousand
12-in.— 10.00 " "

RECORD ALBUMS



10-in. (12 pockets), \$7.50 per doz.
12-in. (12 pockets), \$8.75 per doz.

These albums are of the best quality that can be bought. As our stock is limited, we would advise you to place your order at once.

F. O. B. NEW YORK



Talking Machine CABINET

VELVETONE

Phonograph Needles

The Two Best Selling Propositions in the Talking Machine Trade To-day

The Cabinet & Accessories Company, Inc.

145 East 34th Street Otto Goldsmith, President
Tel. Murray Hill 6470 NEW YORK CITY

STEWART CO. NOW WHOLESALE ONLY

Victor Wholesalers of Indianapolis Dispose of Retail Interests to the Newly Organized Indianapolis Talking Machine Co.—Other Items

INDIANAPOLIS, IND., July 3.—Arrangements have been completed for the sale of the retail interests of the Stewart Talking Machine Co., in the store at 110 Pennsylvania street, to the Indianapolis Talking Machine Co. Carl R. Anderson, until recently with the American International Ship Building Corp., is president of the new company, and E. R. Donnell, of Indianapolis, is treasurer. The new company will take charge of the store this month. The store will be redecorated, a tile floor laid and new booths added.

The Stewart Talking Machine Co., which



C. R. Anderson, Mgr. Indianapolis T. M. Co. was a pioneer in the Indianapolis field and for a number of years was the only Victor dealer in the city, will devote its interests exclusively to the wholesale field.

Mr. and Mrs. A. M. Stewart, George E. and James T. Stewart have been at Atlantic City attending the Victor Jobbers' Convention.

That the time is ripe in Indianapolis for an organization of Victor dealers is the opinion of H. E. Whitman, of the Circle Talking Machine Shop, who hopes that the Victor dealers will take steps to organize for the purpose of looking after the interest of the Victor product. Mr. Whitman is running a series of moving picture advertisements, featuring customers carrying Victrolas out of his store.

THE MOTROLA



"STOP GRINDING"

Winds any phonograph spring at the touch of a button.

Easily attached by anyone in place of winding handle — positive in operation.



OFFERS DEALERS NEARLY 100% PROFIT



Our national advertising campaign is creating an enormous demand.

You cannot afford to be without a Motrola on your demonstrating machine.

Ask your jobber or write us to day for further particulars.

JONES-MOTROLA, Inc. NEW YORK, CHICAGO, LOS ANGELES :: 29 West 35th Street :: 57 E. Jackson Blvd. :: 1967 No. Bronson Ave.

Ernest L. Arthur, manager of the exclusive Sonora department of Charles Mayer & Co., is greatly pleased with the way the business of the new department is coming in. Mr. Arthur is pushing the Sonora to the front. Display billboard advertising is part of the campaign the company has adopted in aggressively going after business.

W. G. Wilson, manager of the Grafonola Shops, Inc., says there has been a demand for the portable machines for summer use, but the difficulty has been in getting such machines.

Columbia dealers who attended the regular monthly meeting at the Hotel Lincoln were enthusiastic over summer prospects. Ben Brown, manager of the local wholesale branch of the Columbia Co., promises the dealers that there will be a marked improvement in the supply of records soon. Olin Bell, of Bell Bros. Piano Co., of Muncie, Ind., spoke on the sales qualities of a number of records which were played at the meeting.

William Cobin, special representative of the Dictaphone, was in Indianapolis this week. On June 19 Mr. Brown met with the Evansville Columbia dealers at the McGurdy Hotel in Evansville. G. A. Brentana, an Evansville advertising man, and Mr. Brown spoke.

George Standke, manager of the Brunswick Shop, was one of the live wires of the Indianapolis members of the Optimist Club who attended the International convention at Louisville, Ky., June 19 and 20. Mr. Standke assisted in electing H. G. Hill and J. M. Schmidt, of Indianapolis, to offices and also in bringing the national headquarters to Indianapolis.

During the recent meeting of the Shriners' Imperial Council here Mr. Standke pulled a fine window display in the form of the mysterious Wilmont, of Chicago. The crowds were kept guessing as to whether Wilmont was a dummy or a live man.

The A. M. Club, of the talking machine department of the Pearson Piano Co., is scoring some big hits through window decorations. Following a clever scene illustrating the Victor record, "By the Camp Fire," the club put in a window to feature "When You Look in the Heart of a Rose." A rose bower covered a Victrola on one side of the window and on the other side was an Edison with a large rose and inside the rose was a "Splash-me" doll. The record is offered by both the Edison and Victor and makes an ideal window display.

A. H. Snyder, manager of the Edison Shop, reports that June business was good and that the store is keeping up its record of a 90 per cent. increase over last year.

The Fuller-Ryde Music Co. scored a hit during Shriener week with a clever desert window scene with a nodding camel. C. J. Fuller reports that the Victor business continues good.

E. R. Eskew, manager of the Pathé Shop, is more than pleased with the way Pathé business boomed during June.

At the Kipp Phonograph Co., Edison distributors, the chief worry continues to be the ability to get goods fast enough from the factory.

Mooney-Mueller-Ward Co., Pathé distributors, has been getting records in a trifle better, but the demand for records and machines still exceeds the supply.

Frank Buttweiler, manager of the local branch of the Brunswick-Balke-Collender Co., has a stack of prospective dealers on his file and he is hoping that conditions will permit him to increase the Brunswick business in this territory soon.

H. J. SMITH LABORATORIES

Jewel Manufacturer

EXECUTIVE OFFICES,
FINISHING and
RECORDING
LABORATORY JEWELS

Plant No. 1
833 Broad Street
Telephone 2896 Market
NEWARK, N. J.

SAWING
GRINDING
ROUGHING
ROLLING and
EXPERIMENTAL
LABORATORY

Plant No. 2
54 1/2 Franklin St.
NEWARK, N. J.

Manufacturer of

Phonograph Diamond and Sapphire Reproducing Points—Recording Laboratory Jewels—Rough Diamond—Diamond Powder—Experimental Work. Jewels manufactured for all talking machine records. Consulting Specialist on all experiments relating to any new recording grooves. Recording problems satisfactorily worked out.



\$52,000 worth of sales and advertising ability



will work for you at 1/4 the cost of an office boy!

THE men who create the Talking Machine World Service are strong executives—at the top of the advertising profession and they know the talking machine business from start to finish.

For you these men will write advertising copy with the selling ideas that will fill your store with customers.

Just now, when you can sell all the machines you can get, you want copy that builds up your PRESTIGE, so that you'll be ready to overcome competition later on.

You want new business-getting ideas that you can use to boost your sales—

You want your copy illustrated by well known artists—

You want plans for window dis-

plays that will stop the crowds and make them look—

You want form letters written by a specialist who is paid regularly \$100 for a single letter—

You want a complete sales promotion service that comes to you every month brim full of \$52,000 worth of horse-power, pep and ginger—

If your store is small, the Talking Machine World Service may be worth \$2500 per year to you. If it is big, the Service may be worth \$25,000. The mechanical value of 204 mats or electros per year of striking illustrations with the advertising copy, form letters, window display suggestions, etc., is worth the small amount that the Service costs you.

ILLUSTRATIONS for the Talking Machine World Service are made by such artists as OLGAD THOMAS and ARTHUR FINLEY of "Vogue," CHARLES BASKERVILLE, Jr., whose work you can see in the July issue of "Scribner's"; HERMAN PALMER, famous as a regular contributor to "Judge"; FREDERICK T. CHAPMAN, who has illustrated the Arrow Collar advertisements, as well as many other artists.

This is what—THE TALKING MACHINE WORLD SERVICE

—brings you, and it costs you about 1-4 as much as an office boy, because we are selling it to hundreds of dealers all over the United States, thereby dividing the cost into small

units. We can't explain in one page a proposition as big as this. Send for a complete digest of the Service with full information and samples of the kind of work we do for you.

But remember—Only one dealer in each territory

—and it is strictly first come, first served!

We want the best dealer in every territory to get this Service—not necessarily the largest, but the fellow who has both eyes wide open and will make the most thorough use of it when he gets it. If you're the man, sign this coupon before your competitor does.

You don't have to take this proposition on faith. We show you in advance just exactly what you get, and you can decide for yourself.

Fill out the coupon at once. The postmark on your letter will determine who is first when two or more inquire from the same territory.

Sign and mail this coupon today!

THE TALKING MACHINE WORLD SERVICE

373 FOURTH AVE., NEW YORK

I want to be shown—I want you to prove to me just what you can do. Send me full information about your Service with specimens of the art work, form letters, advertisements, etc., etc., and tell me how much it will cost per month under your syndicate plan.

The population of my territory is.....
I handle the following make or makes.....
Firm Name.....
By.....
Street and Number.....
City and State.....

The most wonderful Talking Machine of the present age at the price
An Instrument of Supreme Value, Tone and Quality

Clearstone
SPEAKS FOR ITSELF



No. 250—\$125



No. 150—\$85



No. 100—\$75



No. 200—\$100

The *Clearstone* has become very popular because of its quality, splendid value and the advertising and sales campaign that now stands in back of it. **Dealers!** Watch us grow—write for our agency and grow with us.

SUNDRY DEPARTMENT

MOTORS—No. 1, double-spring, 10-inch turntable, plays 2 10-inch records, \$3.25; No. 6, double-spring 10-inch turntable, plays 3 10-inch records, \$4.00, with 12-inch turntable, \$4.25; No. 8, double-spring, 12-inch turntable, plays 3 10-inch records, castiron frame, \$6.85; No. 9, double-spring, 12-inch turntable, plays 3 10-inch records, castiron frame, bevel gear wind, \$7.85; No. 10, double-spring, 12-inch turntable, plays 4 10-inch records, castiron frame, bevel gear wind, \$9.85; No. 11, double-spring, 12-inch turntable, plays 7 10-inch records, castiron frame, bevel gear wind, \$10.75.

NEEDLES, steel, 45c. per thousand in 10,000 lot; 42c. per thousand in half million lots.

WE also manufacture special machine parts, such as worm gears, stampings, or any screw machine parts for motor; reproducer and part manufacturers. Special quotations given to quantity buyers in Canada and other export points.

RECORDS—POPULAR AND GRAMMAVOX, new 10-inch, double-disc, lateral cut, all instrumental selections 35c. each; 32c. each in 100 lots; Columbia, 10 inch, double-disc, new records, 35c each.

GOVERNOR SPRINGS—To fit VICTOR, COLUMBIA and all other motors at moderate prices. Special prices on large quantities to Motor Manufacturers.

GENUINE DIAMOND POINTS, for playing Edison records, \$1.95 each.

SAPPHIRE POINTS, for playing Edison records, 22c each.

Special prices on sapphire points, balls, and diamonds for quantity buyers.

SAPPHIRE BALLS, for playing Pathé records, 22c. each.

NEEDLES, steel, 45c. per thousand in 10,000 lot; 42c. per thousand in half million lots.

WE also manufacture special machine parts, such as worm gears, stampings, or any screw machine parts for motor; reproducer and part manufacturers.

Special quotations given to quantity buyers in Canada and other export points.

Write for our 84-page catalog, the only one of its kind in America, illustrating 33 different styles of talking machines and over 500 different phonographic parts, also gives description of our efficient Repair Department.

Lucky 13 Phonograph Co., 46 East 12th St., New York

Massenet's "Elegie" sung by Stracciari with a violin obbligato by Sascha Jacobsen: A famous song, a famous singer, and a famous accompanist. Columbia 49333.

**Columbia Graphophone Co.
NEW YORK**



FINE NEW QUARTERS IN MILWAUKEE

Work Well Under Way on the New \$75,000 Building Being Erected in That City for the Use of the Kesselman-O'Driscoll Co.

MILWAUKEE, Wis., July 8.—A beautiful building of classic design, costing about \$75,000, is being erected by the Kesselman-O'Driscoll Co., 258 West Water street, on the triangular plot



New Kesselman-O'Driscoll Building

bounded by Wells, West Water and Second streets, for its large and growing business. The company now handles the Victor and Edison lines exclusively, but when it takes occupancy of the new store a complete line of pianos, players and grands, music rolls and other accessories and supplies will be added. The unusual success which has characterized the progress of the company in the talking machine business gives the Kesselman-O'Driscoll Co. a splendid prestige and paves the way for the development of one of the largest and strongest music houses in Milwaukee.

Only a few years ago Louis M. Kesselman and Michael O'Driscoll started a small Victor shop at Twentieth street and Fond du Lac avenue. Within a short time it established a city-wide reputation for good service, making it necessary to expand and choose a more central location to maintain the high standard of service. Accordingly the company bravely invaded the heart of the downtown district, locating at 258 West Water street. This was two years ago in May. Since that time the Edison line was added. Now a full piano business is being established.

The "music temple," as the new Kesselman-O'Driscoll Building will be called, is illustrated herewith. It will be four stories high, with foundations to carry five or six additional floors when these are needed. The location is ideal, being only a block from Grand avenue.

Those who know the ability, energy and in-

dustry of the members of the company predict a bright and prosperous future in its second epochal move when the temple is completed about September 1 or 15.

SPECIAL DEMONSTRATING MACHINE

Novel Machine Used by Los Angeles Dealer in Demonstrating Records—Specially Designed and Suitable for Store Only

LOS ANGELES, CAL., June 28.—Shown in the accompanying illustration is a specially constructed desk talking machine for demonstrating new records, intended to enable the customer to leisurely and comfortably wait upon herself. It is, of course, for use in the store in the selling of records and not for entertainment in the home. Designed somewhat along the lines of an ordinary writing desk the machine is operated in the usual way and the disc and needle are within convenient reach of the person seated before it. Taking the place of pigeon-holes on one side is a rack for records to be played and on the other side is a partitioned rack for those selected and rejected. There is also a holder for catalogs and underneath the glass of the partly covered top are lists of the latest numbers. A small glass cover fits down over the playing part when not in use.

The machine, which has been named a Phonograph Console, represents the idea of William H. Richardson, of the new Los Angeles music house of Richardson's, Inc., at 607 West



A Novel Demonstrating Machine

Seventh street, where the machine here shown is on exhibition and in use. It is of mahogany finish and very attractive in appearance.

The Hopper-Kelly Music Co., Seattle, Wash., is making extensive improvements in its present quarters, and it is expected that a formal opening will be held within a short time.

The KENT Master Adapter

MADE UNDER PATENT No. 1,130,298

It is not an attachment nor a makeshift, but a part of your phonograph.

It is simple, neat and durable.

It is sturdily and honestly built.



Position when playing lateral cut record

It is attractive in appearance and absolutely fool-proof.

It is correct in principle and accurate in performance.

It is guaranteed.

Makes any disc record playable on the NEW EDISON DISC Phonograph

Write us for special literature covering the particulars about this ingenious device

F. C. KENT CO.

MULBERRY and CHESTNUT STREETS
NEWARK, N. J.

ACME TONE ARMS ACME REPRODUCERS ACME PHONOGRAPH MOTORS

Are the supreme combination of
mechanical engineering science and the
art of true and natural tone reproduction

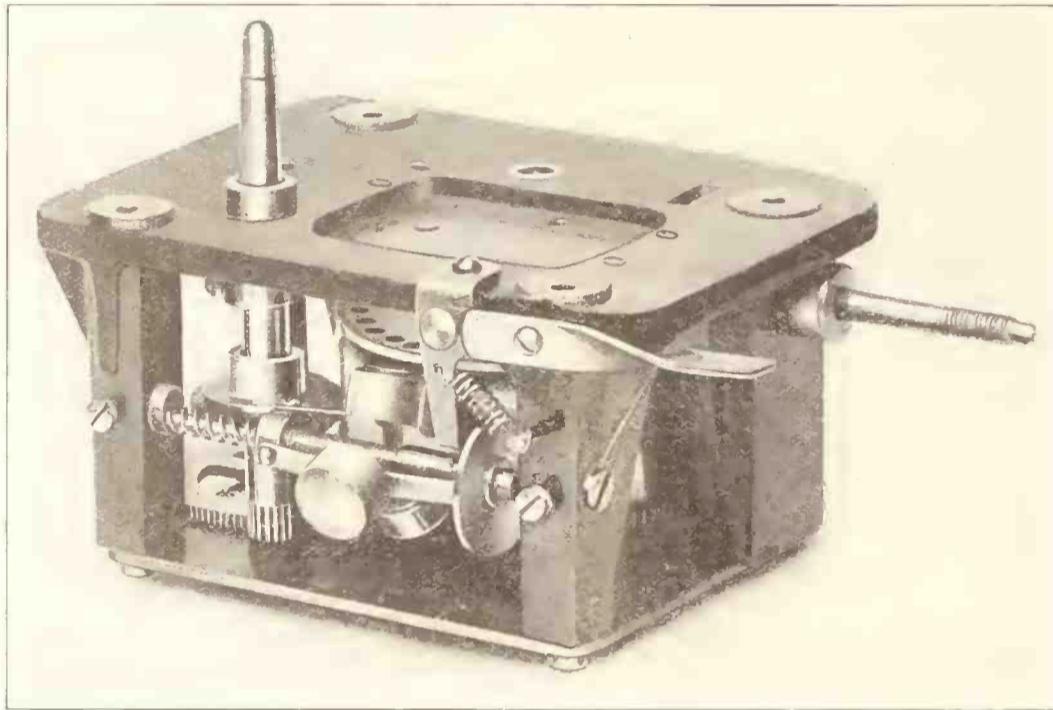

MODEL B

Model B1 is a single spring, cast iron frame motor easily wound, smooth running and absolutely silent. It is fully equipped with adjustable brass bushings and can be accurately regulated. This motor is recommended for medium priced instruments and guaranteed to be high-class and satisfactory in every particular. Length of run 14 minutes.

Model B2 is of the same construction as B1 except that it is equipped with double spring. Length of run 19 minutes.

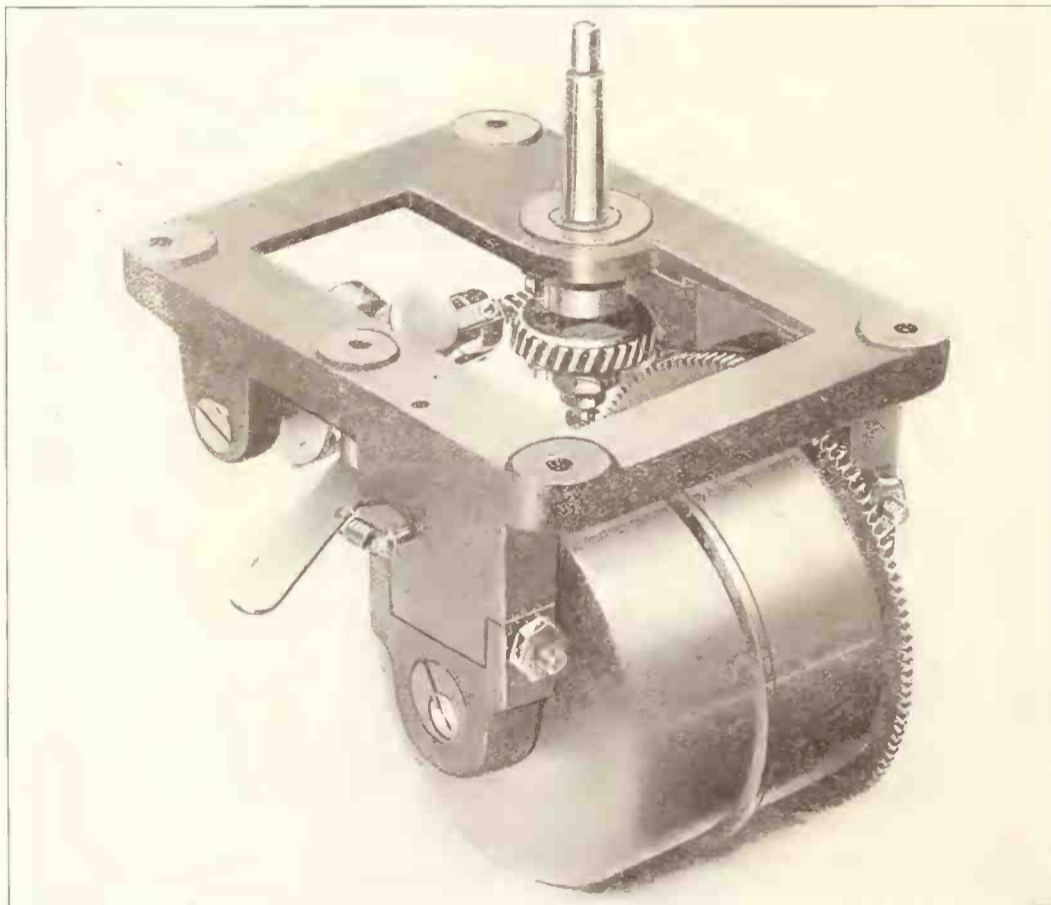

MODEL C

Model C is a double spring, cast iron frame motor which is guaranteed to supply all the requirements of the highest type instruments. This motor is constructed from the best materials obtainable and all parts are made by expert precision tool makers. It is considered equally efficient to any high-grade motor on the market. Length of run 35 minutes.

All motors to fit either wooden or metal cases. Large quantities of these motors can be supplied promptly at attractive figures. We can also furnish special motors to fair specifications.

Acme Phonograph Corp.

Tel. Barclay 7633
7634

*Makers of phonograph specialties for the
trade. Anything made to your specification*

**46 Murray St.
New York City**

SOME INTERESTING DEVELOPMENTS IN ST. LOUIS TRADE

J. F. Ditzel Blossoms Out as an Author—Victrolas Cheer Telephone Girls During Strike—Tri-State Association After Misleading Advertising—Business Conditions Reviewed

St. Louis, Mo., July 2.—Business was good in St. Louis in June in talking machines and records. The only thing that kept it from being better was scarcity of machines. The supplies on hand and obtainable were not sufficient to meet the public's demands. That is not saying that at any time during the month a person who wanted to buy a talking machine could not find one. But it is saying that the person who wanted to buy was lucky if he found the kind that he wanted.

Manager J. F. Ditzel, of the Famous & Barr Co., by the way, is about to break into literature. He has taken his pen in hand and written an epic about women and music and how music helps women to bear the grind of the day's toil. He is going to send it forth in attractive pamphlet form to do its creative work in bringing to women the message that music waits to serve them at their tasks.

The Bell Telephone Co. thinks that music has charm to keep its girls in line when there is a strike on. The company has purchased a number of the Victor \$90 styles to beguile the rest hours of the girls, who have to be kept in the exchange buildings during the strike. They were bought from the Famous & Barr department and Manager Ditzel remarks that there is a noticeable tendency among industrial corporations to supply talking machines for the stimulating of their employes during luncheon and other relaxation periods.

The Tri-State Victor Dealers' Association, which has been somewhat somnolent of late, woke up this week when President Reis, glancing through a telephone directory to see how his ad looked, saw another ad which did not look good to him. It told how a small dealer on the South Side had Victrolas, Brunswicks and one of the 57 varieties of olas. The executive committee of the Tri-Staters was hurriedly convened and an inquest held, at the end of which the matter was referred to the Better Business Bureau. The Tri-Staters are attracting a good deal of attention. An inquiry was received the other day for a copy of the constitution and by-laws from a group of Southern dealers, who are planning to get together in the same way.

Invitations have been sent by Manager C. L. Staffelbach of the Hellrung & Grimm Pathé department to all his dealers in Illinois and Missouri to come to town next Wednesday, Thursday, Friday or Saturday, or all four, and hear Mr. Parsons, of the Pathé Frères, New York, demonstrate the new Pathé Actuelle. Between 150 and 200 dealers are expected.

J. A. Schlichter has been appointed manager of the retail department of the Silverstone Music Co. He succeeds W. W. Mitchell, who resigned and has gone to his home at Waterloo, Ill. Leo M. Schlude, assistant manager for six years, has resigned to take the management of the B. Nugent & Bro. talking machine department. H. H. Ray, formerly with the Kieselhorst Co., is his successor. Mark Silverstone and M. Goldberg were in New York attending the Edison meeting.

The new quick-service record department at the Smith-Reis store is getting under way.

Several of the stores along Olive street lit up with red lanterns for the advent of the "Red Lantern" Victor records yesterday.

The Krite-Boyens Piano Co., which has been at Grand avenue and Olive street, opened Monday in its new store at 1012 Olive street. The Columbia department has very attractive French art glass bottles at the rear of the store. Miss Bertha Strasser is in charge.

John McKenna, of Chicago, has been appointed manager of the Columbia Graphophone Co.'s St. Louis branch, succeeding A. W. Roos, who becomes assistant manager. The Columbia people are planning a big get-together meeting about the middle of July at the Hotel Statler for all the dealers in St. Louis and the branch's territory, including Little Rock, Memphis and other cities. About 150 are expected.

C. R. Salmon, city salesman for the Columbia, finished first in the needle drive for the St. Louis branch. He sold his million in ten days and was the fourth to finish his quota.

The Brunswick Shop is a new institution at Alton, Ill. It is at 309 Belle street and is in charge of R. J. Smith.

A. S. Engelmann, of the St. Louis Brunswick store, says he has taken no new orders for nine months because he did not think it fair to the old dealers whose orders are back. He has received assurances of great improvement in the deliveries next month.

The Mackey Furniture Co. has rented the five-story building at 1122 Olive street, adjoining it on the east, for pianos and Grafonolas. In the main store the musical instruments have not had a department of their own.

Manufacturers

of

PHONOGRAPHS

and

PHONOGRAPH CABINETS

are invited to write us for samples of Trimmings and Parts such as

Catches, Sockets, Pulls, Knobs, Escutcheons, Sliding Shoes, Lid Supports, Automatic Stops, Tone Rods, Needle Cups, Etc.

Our line of such hardware is complete and with our increased facilities we are in a position to give reasonably prompt service to a few more desirable customers.

GRAND RAPIDS BRASS CO.

GRAND RAPIDS, MICHIGAN

WHY WALL-KANE NEEDLES ARE SUPERIOR

The highest grade steel needle of American manufacture, and playing only one record, is put through a complicated, scientific, chemical process, by which the point of the needle is greatly improved. The popular explanation of the method is as follows:

An ordinary steel needle is made of wire, which consists of long, parallel running grains on the inside. This wire is inserted in automatic machines, which automatically cut off the steel needles.

The friction of the revolving record grooves will gradually flatten out the point of the needle, so that more and more grain of the steel will reach the record grooves. The WALL-KANE needle will eliminate the grain of the steel coming into contact with the grooves by a process which is accomplished as follows:

The steel needle is first dipped into a chemical solution which will take out most of the charcoal, making a closer unit of the needle.

Then the needles are dipped in several solutions, which place three different coatings on the top of the point, so that an entirely separate unit is created on the point, very much smoother and 25 to 30 per cent. softer than an ordinary steel needle's point.

More than three thousand revolutions are required to take off these three coatings by the friction of the point with the record. The playing surface of more than ten records do not amount to 3000 revolutions—that is why WALL-KANE needles will play at least ten records perfectly, and will make less surface noise, and by the distribution of the solution into the grooves of the record, the record itself will be greatly benefited, and its life prolonged.

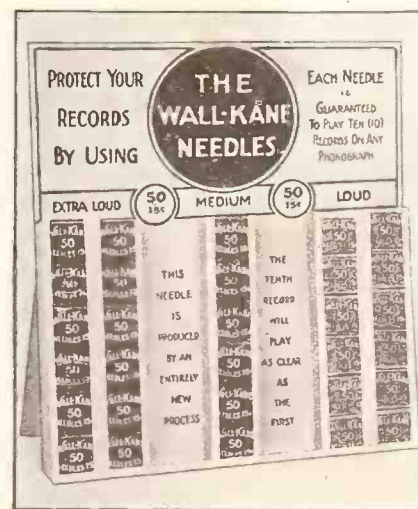

BEWARE OF IMITATIONS

Package of 50 WALL-KANE needles, Loud, Extra Loud and Medium, greater value than 500 ordinary needles, retails for 15c, costs the dealer 7½c., 8c. in the Far West.

JOBGING TERRITORIES OPEN

Progressive Phonographic Supply Co.
145 West 45th Street, New York

*Team-mates that "pull" for
bigger business steadily:*

Starr Phonographs Gennett Records

The dealer who hitches that pair to his business speedily learns that they take him forward along the High Road of Success at a "get there" gait.

PRESTIGE—PRESTIGE, the growth of fifty years of keeping fast to the motto, "Nothing But the Best," feeds the energy that keeps that team flying ahead on the road of Popularity.

STARR Phonographs are known wherever people live, for their matchless tonal qualities. "The singing throat of the Starr," a throat made of the wonder-wood, Silver Grain Spruce, from which the priceless violins of past ages were fashioned, is famous everywhere for the beauty and richness it gives the tones of the Starr.

GENNETT Records, played on all makes of phonographs, *improve the tone* of any phonograph, a power given them by the exquisite care with which each one is made. They are recorded in New York, from the latest musical "hits."

The dealer who handles STARR Phonographs and Gennett Records "cashes in" on the world-wide prestige of all products of the Starr Piano Company.

The Starr Piano Company

Richmond, Indiana

VICTOR CO. OBTAINS INJUNCTION AGAINST INFRINGER

U. S. District Judge Issues Injunction Against Charles E. Garvin and Associates Restraining Them From Manufacturing or Selling Talking Machines Infringing Victor Patents

CHICAGO, ILL., June 30.—The Victor Talking Machine Co. came out victorious in a legal battle which culminated to-day. The principals were the Victor Co. vs. Charles E. Garvin et al. To the Judges of the U. S. District Court of northern Illinois the Victor Co. petitioners showed that in January, 1918, they had filed their complaint bill for infringement of Letters Patent Nos. 814786, 814848, and 947227, and that action for preliminary injunction was made on the affidavit served and filed under an order to show cause, but prior to the hearing of said motion the defendants filed a joint answer disclaiming infringement as alleged in the bill. At the next hearing in February a final decree was entered adjudging the letters patents good and thereby an infringement of No. 914786 as to claims 2, 3, 6, 18, 21, 30, 37, 41 and 42, also No. 814848 as to claims 7, 9, 10 and 11 and No. 947 as to claims 29, 31 32 and 37, and directing a writ of perpetual injunction for the reason that no appeal had been taken and that the time for appealing had expired.

On March 8, 1918, the perpetual injunction was issued and served on the defendants by the Deputy Marshal with summons.

It was alleged that C. E. Garvin, president and treasurer; August Hurt, vice-president, and Josephine Garvin, secretary, all of the Garvin-Brown Talking Machine Co., of Chicago, had manufactured, sold and continued to manufacture and sell during the proceeding, talking machines, amplifying horns and sound-reproducing devices, embodying and containing the inventions specified in the above-mentioned claims, and more specifically exemplified in the plaintiff's exhibit of the defendant's "Blackstone" produced in the court.

After a two days' hearing, during which the affidavits of a large number of prominent men in the trade were heard, Judge Anderson issued the following order, which became effective and in force immediately:

"First: The talking machines exemplified in the plaintiff's exhibit, defendant's Blackstone machine and manufactured by Charles E. Garvin, Garvin-Brown Co., Josephine Garvin and August Hurt are within the injunction heretofore issued herein against Charles E. Garvin, and that a writ of attachment for contempt issued forthwith against said Charles E. Garvin, Garvin-Brown Co., Josephine Garvin and the said August Hurt.

"Second: That an injunction be issued forthwith against Charles E. Garvin, Garvin-Brown Co., Josephine Garvin and August Hurt, and each of them, and each of their agents, attorneys, clerks, servants, employes, workmen and all holdings through or under them from further manufacture or causing to be manufactured, selling or offering for sale, using or causing to be used, talking machines identical with or like or similar to plaintiff's exhibit, defendant's Blackstone machine, or similarly made in imitation of plain-

tiff's talking machine and for dissipating or parting with their assets until the further order of the court.

"Third: That this cause be referred to Charles M. Morrison, as master, to ascertain and report to the court the character and extent and circumstances of the violation of the injunction herein by the said Charles E. Garvin, by the said Garvin-Brown Co., by the said Josephine Garvin and by the said August Hurt, with authority to examine said Charles E. Garvin and said Garvin-Brown Co. and said Josephine Garvin and said August Hurt and each of them, and each of their officers, agents and employes, and to cause the production of their books for the above or any other purposes and the books of each of them to ascertain and report to the court the names of all purchasers of talking machines sold in violation of said injunction by the said Charles E. Garvin, by the said Garvin-Brown Co., and by the said Josephine Garvin and by the said August Hurt, with the addresses of said purchasers, the quantity and the dates of sale and of shipment and the prices received on each sale by the said Charles E. Garvin, defendant, the said Garvin-Brown Co., or the said Josephine Garvin, or the said August Hurt, and to ascertain and report to the court the total

profits made by the said Charles E. Garvin, Garvin-Brown Co., Josephine Garvin, and by the said August Hurt, from the manufacture and sale of talking machines within the injunction since the 12th day of March, 1918, down to and including the last sale thereof, and the total damage of every kind and description caused the plaintiff thereby, and to ascertain and report the total expenditure made by, or for or on account of plaintiff in ferreting out and following up the said violation of injunction and in bringing the facts to the attention of the court in and by this proceeding and to and including the end hereof, and also the total expenditure of plaintiff in and for the main case.

(Signed) "Albert B. Anderson, Judge."

DROP LEVY ON AMERICAN FREIGHT

WASHINGTON, July 1.—Information has reached the Bureau of Foreign and Domestic Commerce that British shippers have been informed by the Atlantic Transport Line, Cunard Line, Leyland & Co. and other ocean carriers that hereafter the 5 per cent. levy on all freights and charges payable in the United States would not be collected. The levy was instituted at a time when the exchange rate was greatly to the disadvantage of Great Britain.

Louis Elting, 114 No. Broad street, Trenton, N. J., has leased another floor and will add a talking machine department.

**Let Us Make Your Cabinets
And Install Your Motors**



We know how to build Cabinets, and to construct the horn that will produce a loud tone, yet it comes from the bell of the horn perfectly soft and mellow. Hook the selling force into our Secret of Cabinet building and watch both ends grow.

Write us your wants at once.

PARAGON MFG. CO., Inc.
HICKORY, N. C.



CLEANS
REVIVES
PRESERVES

MAKES OLD RECORDS PLAY LIKE NEW

INSURE YOURS TODAY BY USING *Tone-Clean*
FOR USE ON ANY MAKE OF RECORD

A 100% ARTICLE WITH A 100% GUARANTEE.
LENGTHENS THE LIFE OF ANY RECORD. ONE BOTTLE SUFFICIENT TO CLEAN 250 OR MORE RECORDS

THE IDEAL CLEANER

A liquid that positively removes every minute particle of dirt, dust and grease; will not injure—but IMPROVES AND LENGTHENS THE LIFE of any record. TONE-CLEAR reduces the chance of damage to records by 90%.

BEWARE OF IMITATIONS

ASK FOR AND DEMAND TONE-CLEAR ONLY

Jobbers and dealers, send us a trial order. Price \$4 a dozen. Retail 50c. a bottle. Be the first one to introduce it in your territory. Send for circulars and detailed information.

WAX-WILSON COMPANY

Manufacturers Agents

204-5-6 Fenton Building, Portland, Ore.

Exclusive Selling and Distributing Agents for the United States and Canada

Manufactured by Davis Products Co., Portland, Oregon

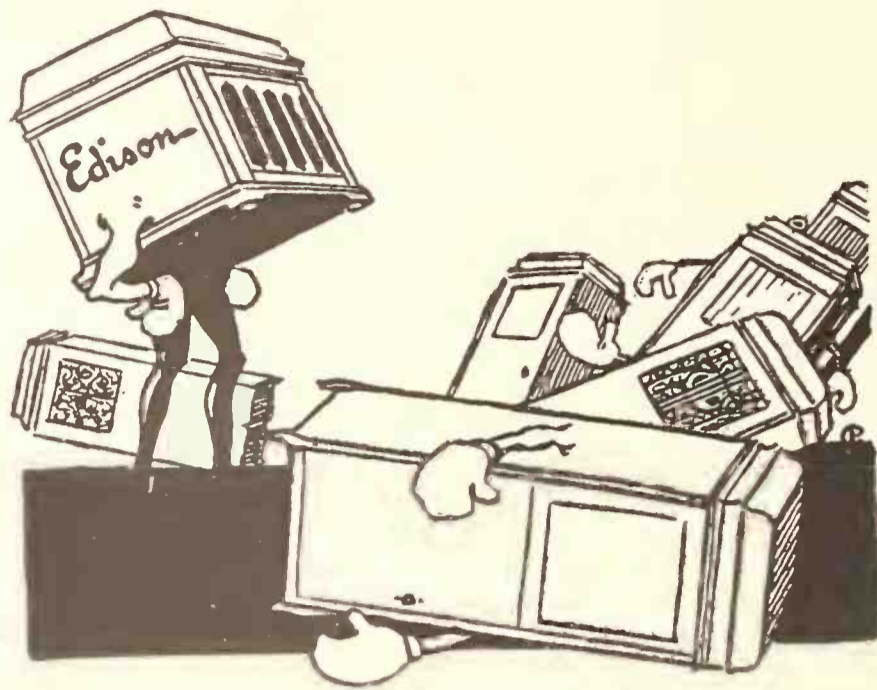

JACK THE GIANT KILLER UP-TO-DATE

There is a phonograph modest in size, inexpensive in price that is a Modern Jack the Giant Killer. It is called the

=====**New**=====

Edison Diamond Amberola

In competition with talking machines, costing three and four times as much, this little instrument has proved itself able musically to defeat all comers.

Competitive tests between the New Edison Diamond Amberola and the best known talking machines have been made behind curtains to insure absolute fairness and the result has always been the same. The New Edison Diamond Amberola has been, in most cases, unanimously voted the musical superior of its competitors by the most competent judges of phonographs and talking machines.

The little folder, "Jack the Giant Killer," tells in detail about these tests. Let us send you a copy, and tell you where you may hear this high quality, low price Edison instrument.

Thomas A. Edison, Inc.

Amberola Department

ORANGE, N. J.

EXPANSIVE PLANS OF TRADE IN LOS ANGELES

Talking Machine Dealers' Association Broadens Name to Music Trades' Association—Outlines Policy—Month's News Budget

LOS ANGELES, CAL., July 3.—The Retail Talking Machine Dealers' Association of Southern California, which was organized in this city something over a year ago, has now become the Music Trades Association of Southern California, which means that it has been expanded to embrace not only the talking machine dealers but also the dealers, both wholesale and retail, as well as manufacturers and jobbers, representing every branch of the music business. In other words, it has become, as its new name signifies, a general music trades association. The proposition of broadening its field came up officially at the regular monthly meeting of the talking machine dealers on the evening of June 10, which resulted in the calling of a special meeting for June 24, to which the members of the music trade in general were invited and asked to participate. The latter was held at the Alexandria Hotel, in the nature of a banquet, and was well attended. Besides adopting the new name and the proposition of expanded representation, it was also decided at this meeting to establish a permanent business office and to employ a secretary and manager, at a salary, for the association, to the end that greater and even better work may be accomplished. A committee, composed of E. A. Geissler, of the Geo. J. Birkel Co.; E. P. Tucker, of the Wiley B. Allen Co.; George H. Barnes, of the Barnes Music Co.; H. L. Brown, of the Lyon-McKinney-Smith Co., and Sheldon Morris, of the Southern California Hardwood & Lumber Co., was appointed to make arrangements for securing the secretary-manager and to report at the next meeting, which will probably be held on the evening of July 8. New or revised by-laws are also to be considered at this meeting. The old officers, however, aside from the secretary, are to be retained. On account of President J. W. Boothe being out of the city, the reorganization meeting of June 24 was presided over by E. A. Geissler. The association will be financed by assessing the various member houses on a basis of size or amount of business done, and it is hoped that the membership may be made representative of the whole of southern California.

Although their sales averaged up to a somewhat lower level than that reached the previous month, the talking machine dealers of this city are quite well pleased with their June

record, for it, at least, represents a very material gain over the same month of last year. The first three-quarters of the month, in fact, was exceptionally good, while the closing week was a little quiet. A strike of the employes of the local telephone company, while not completely tying up the system, has been causing considerable confusion to business for the past ten days, and probably has more or less affected talking machine and record sales. The vacation period is also here, of course, and naturally helps toward making business a little slow. The Victor dealers state that they are finding it quite a little easier now to get record orders filled, and are hopeful that they soon will be able to push sales to much better advantage.

Columbia Dealers See Dance Demonstration
An unusually large assembly of Columbia

dealers attended the regular monthly meeting of the southern California Columbia dealers, on June 18, in the ball-room of the Alexandria Hotel. In addition to the playing of the new issues of Columbia records a very interesting demonstration of finished ball-room dancing, to the accompaniment of dance records, was given by Miss Helen Van Pelt, teacher of dancing at the California Temple of Music, and Kenneth McLellan, teacher of ball-room dancing.

Work Started on New Columbia Building

Work was started last month on the construction of the new building for the Los Angeles wholesale branch of the Columbia Graphophone Co. The building will be located on the west side of Los Angeles St., adjoining the corner of Eighth street, and is to be two stories high, with

(Continued on page 134)

CRESSEY & ALLEN
Portland
COVERS
NEW ENGLAND
CONN.
WHOLESALE ONLY
CRESSEY & ALLEN
Victor Distributors
534 Congress St., Portland, Maine

GIVE JOHNNY A JACK KNIFE AND HE'LL WHITTLE Give a Phonograph Owner an Empty Album and He'll Fill it With Records

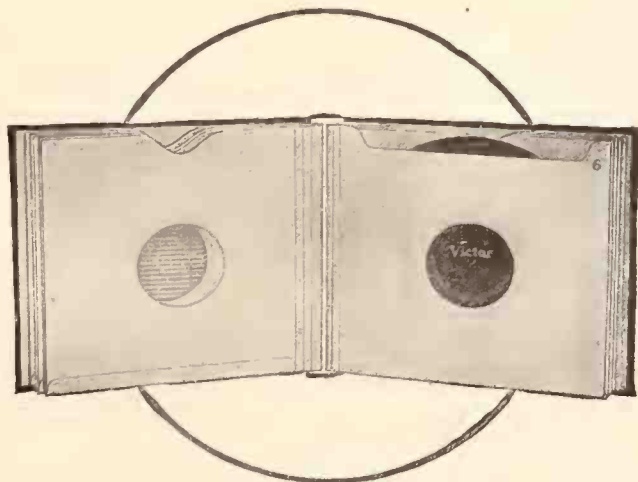

Patented March 3, 1914. Lies absolutely flat when open.

There is hardly a dealer today who does not realize the wide channel for future record business that is opened by the sale of a record album—the Peerless Album. THE EMPTY ALBUM IN THE HANDS OF A PHONOGRAPH OWNER is a constant reminder to buy more records. That is why dealers everywhere like to sell the cabinet type machine equipped with record albums—Peerless Albums.

**A Sales Accelerator—
Peerless Albums**

PEERLESS ALBUM CO.

PHIL RAVIS, President

43-49 Bleecker St., New York



Chicago Office
57 East Jackson Blvd.
W. A. Carter, Representative

New England Representative
L. W. Hough, 20 Sudbury St., Boston, Mass.

Grand Rapids
Chas. W. Kalder
Okeh Building

Pacific Coast
Taylor C. White
Portland, Ore.

THE AMERICAN TALKING MACHINE COMPANY

WHOLESALE EXCLUSIVELY

356 LIVINGSTON STREET
BROOKLYN, N. Y.

VICTOR WHOLESALE
DISTRIBUTORS FOR
OVER 16 YEARS

PLANS OF TRADE IN LOS ANGELES (Continued from page 133)

a frontage of 70 feet and a depth of 135 feet. It will be of concrete construction, finished with a terra cotta front and trim, and large plate-glass windows will be provided to permit of ample street display. The property is owned by James Slanson, and is controlled by the Columbia company under a long lease, which represents a rental in excess of \$60,000. It is to be ready for occupancy early in the fall. William F. Stidham,

manager of the company's southern California and Arizona business, is naturally taking great interest in the structure's progress, and says it is going to enable the branch to take care of its rapidly growing business to very much advantage.

Richardson's, Inc., Formally Opened

The new phonograph and piano house of Richardson's, Inc., at 607 West Seventh street, was formally opened on June 23. Compliments were bestowed upon the new rival in the field by other music firms in the nature of potted palms

and a profusion of flowers, and many visitors called to pay their respects. The store is especially attractive in its interior arrangement and decorative scheme. William Richardson, formerly of the Southern California Music Co., is the manager, and the firm begins business with the agency for Columbia talking machines and records and the Baldwin line of pianos and players.

New Traveling Man for Columbia Line

William F. Stidham, manager of the Los Angeles wholesale branch of the Columbia Graphophone Co., has appointed Charles P. Mack as a member of the traveling staff. Mr. Mack, who, at the signing of the armistice, resigned his commission of second lieutenant in the field artillery, returned to the employ of the Bartlett Music Co. here, with which he had previously been associated for a number of years. Mr. Mack's new appointment will take him to the Arizona field.

New Edison Department Manager

The Fitzgerald Music Co. announces the promotion of John D. Scouller to the position of manager of the store's Edison department. Mr. Scouller has been a salesman in the department for some time, and has proved a very capable man. He succeeds C. H. Yates.

Salmacia Brothers Establish Branch

The Glendale Phonograph & Piano Co., of 109 North Brand street, Glendale, Cal., has established a branch store in the near-by town of Burbank, which was opened for business in quite attractive quarters during the latter part of June. The Salmacia brothers, Frank and Vincent, started the Glendale Phonograph & Piano Co. about three years ago and have been doing an excellent suburban business.

Returns from Tour of Northern Territory

E. M. Bonnell, Pacific Coast wholesale traveling representative of the Sonora Phonograph Co., returned to his home in this city about three weeks ago from a tour of his Northern territory. He says he found it extremely easy to get orders, but adds that he is still having difficulty in getting a sufficient number of instruments to supply his dealers. He is hoping for improvement at an early date.

Capt. Louis O. La Mott Returns

Louis O. La Mott, formerly connected with the talking machine department of the Wiley B. Allen Co. here, is again in southern California, after about eight months' service in France. He has the commission of captain in the Coast Artillery, and is now stationed at Fort McArthur, near this city. He says he will continue in the army.

NEWS OF COLUMBIA VISITORS

Dealers From All Parts of the Country Call at the Executive Offices in New York

Among the recent visitors at the Columbia executive offices were the Layton Bros., who operate a Columbia talking machine store in Montreal, Can. Two of these four brothers have recently returned from Europe, having seen active service in the Canadian army. D. H. Delzell, of Salt Lake City; C. A. Delzell, of Denver, and C. F. Schaffarzick, of Spokane, have also spent a week in New York. D. H. Delzell is in charge of a Columbia jobbing establishment in Salt Lake City, operating under the name of Columbia Stores. C. A. Delzell and Mr. Schaffarzick also operate similar jobbing establishments under the same name in their respective cities. Horace Benjamin, vice-president of the Benjamin Temple of Music in Danville, Ill., who is a progressive Columbia dealer in that locality, also visited the Columbia offices last week. Mr. Benjamin reports an unusual activity in Grafonolas in his city and announces that his present stock is entirely sold.

Built for People Who Want the Best

LAWSON UNIVERSAL PHONOGRAPHS

Play all Disc Records with the Lawson Universal Tone-Arm

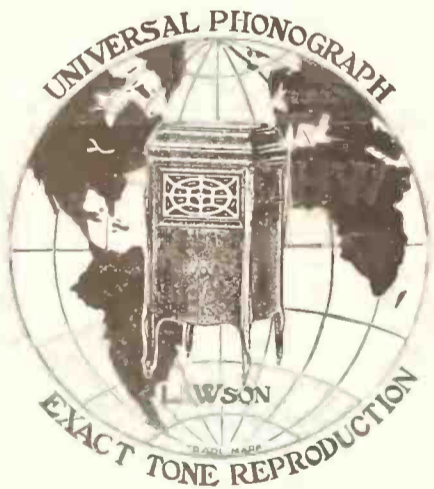

Phonographs that are Good.
Phonographs that sell Good.
Phonographs that stay Good.

Lawson Distinctive
Styles are winning
Admiration



Backed up by

40 years experience in manufacturing Musical Instruments. Also a "Gold Bond Guarantee."

Big Sales are Prophesied for this year. You will be a Winner if you Protect your Bank Balances by Mailing at Once your Application for the Agency.

SOLD DIRECT TO DEALER AT JOBBERS PRICES

LAWSON PIANO CO.

Executive Offices **NEW YORK** Factory
372 East 149th St. **2572 Park Ave.**

We distribute at Wholesale
THE TOURIST PORTABLE PHONOGRAPH
A real high grade Phonograph in a convenient, compact form. Retail price \$35.00. Write for illustrated circular.
COLEMAN MERCANTILE CO.
4421 Manchester Ave. St. Louis, Mo.

Special Announcement to the trade

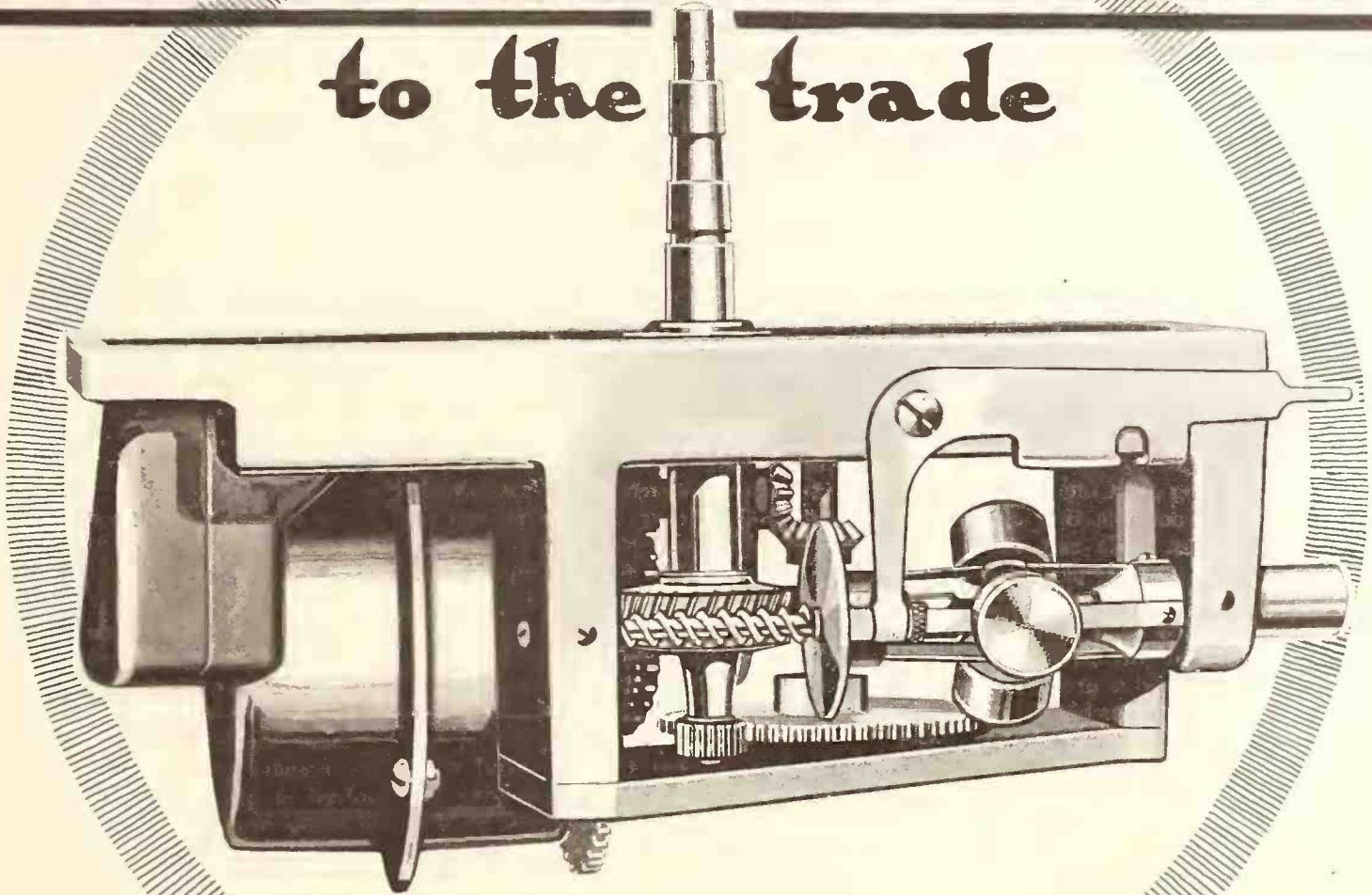

THE DAYTON MOTOR

Made in various sizes for a full line of cabinets from the lowest priced to the highest grade talking machines.

THROUGH Increased Manufacturing Facilities and complete release from Government work, we are enabled to announce that our output for this year will at last be equal to the enormous demand for Dayton Motors.

Those whom we have been unable to supply in the past will be interested to note that there will be plenty of Dayton Motors from now on.

Under the stress of intensive war production and the exacting requirements of the particular work on which we have been engaged, and to which the resources of this plant were applied, we have emerged on a peace-time basis with an organization and equipment the superior to which does not exist.

The training and experience of this strenuous period has developed an aptitude for precision in the men who have now turned their talents and attention from intricate war-work to the no less precise production of the world's greatest phonograph motor.

To the great majority of progressive talking machine manufacturers the Dayton Motor has come to be known as the symbol of advanced ideas—of the highest standards in material, design and manufacture.

The satisfaction and complete absence of motor trouble which the Dayton has brought about for other manufacturers will naturally follow its introduction in your machines.

There will be plenty of Dayton Motors from now on. We are ready to submit samples from stock for your inspection.

The Thomas Manufacturing Co.
Dayton, Ohio, U. S. A.

Featuring the Musical Possibilities of the Talking Machine

By William Braid White

[NOTE.—This is the twenty-eighth of a series of articles on the general subject of the musical possibilities of the talking machine. The aim of the series is to develop these possibilities from all angles, thus opening up fields for sales expansion oftentimes neglected wholly or in part.—Editor.]

THE PERSONAL PART

I am rather of the opinion that the most appropriate title for the present article would be "Featuring the Musical Possibilities of the Talking Machine Dealer." Why I think so will appear, I hope, in the sequel.

In nearly all the matter I have ever read in trade journals concerning the promotion of public love for music, with its commercial corollary, public purchase of musical instruments, the emphasis has invariably been put on the consumer, and never on the seller. Ingenious gentlemen write ingenious articles to show why the dear people ought to buy pianos or talking machines in enormous quantities, and thus be happy ever after. The arguments are often as ingenious as their writers, though once in a while one finds them by way of being a bit ingenuous instead. But the interesting point is that one never, or at least hardly ever, finds any emphasis on the seller's part in this proposed spiritual opening-up.

The Steak Fallacy

The superficial-minded person will argue that to sell beefsteak one need not be a grower of cattle, and that therefore talking machines can be sold without a knowledge of music on the part of the salesman. The analogy, however, is rather painfully inexact. If beefsteak were something which the public rather had to be taught to love then the best salesman would undoubtedly be the man whose wide acquaint-

ance with the habits and nature of steers best fitted him to discourse with conviction, not to say enthusiasm, concerning the true relative value of various cuts of meat. The public indeed considers itself well able to choose its own meat. Does any one believe that it is yet ready to formulate its own demand for music and insist on getting its money's worth as well as what it asks for?

"Salesmanship"

The idea that a merchant need have no technical knowledge of the goods he sells embodies a fallacy that seems to die hard; yet is in fact dying more and more rapidly. The fallacy rests upon the assumption that selling is to be done by the exercise of a faculty called "salesmanship," which appears to mean the art of persuading the public to buy goods without reference to their intrinsic value. The worship of "salesmanship," however, has come to suffer an eclipse during recent years and to-day the business world, speaking broadly, is beginning to see that real "salesmanship" is exchange and nothing else. In a word, the business world sees that a sale in which both parties to the transaction make a profit is the only real sale; and that unless the merchant sells a full measure of satisfaction with each piece of goods he will not remain in business very long.

A few years ago, no doubt, such talk as this would have been greeted with sneers. To-day those who sneer take care to sneer alone and apart.

The truth, then, is that the successful merchant is he who best knows how to give the public what it wants and who begins by discovering for himself that what the public wants usually has to be taught to the public first. That

merchant usually makes another discovery, which is that when the attempt is made to guide public taste intelligently the tendency of public desire is up and not down. Forward and not backward, towards the better and not towards the worse. In these words, indeed, may be summed up the experience of every great merchant; nay, of every man who has ever influenced permanently public thought.

"Selling Noise"

A merchant, in other words, is not fulfilling the requirements of his job if he is not thoroughly posted on the nature of his goods, on their technical features, and on the particular science or art which they subserve. A talking machine dealer who knows nothing about music, and hardly more about the mechanism of his machines, is a very unsatisfactory sort of person with whom to do satisfactory business. In fact, it is fair to suppose that satisfactory business cannot be done with him. It is all very well for such a merchant to say that he deals with many hundreds of men and women who want noise and nothing else. The answer is simply that if you sell talking machines and records on the basis of noise you sell them as noise machines and noise records. If you sell them on the basis of music then alone can you be selling them, and charging good round prices for them, as music-machines and music records. But to sell that which reproduces music, without anything about music, is exactly like selling real estate without knowing the location, the surroundings, the scenery or the nature of the buildings involved in the transaction. That sort of salesmanship might sell real estate during a land-boom, but it decidedly will not "go" at any normal time. Neither will ignorance take the place

"LAUZON" Phonographs



IN THIS AGE of science and progress, buyers of phonographs are becoming more exacting and critical each day. The cheap trouble-making talking machine is doomed soon to be a thing of the past. It is with a full knowledge of present conditions, that "Lauzon" phonographs are designed and made—they offer a foundation upon which a lasting and profitable business can be built.

THE CABINETS are works of art and harmonize with the better types of Period Furniture—beauty of case design is commensurate with beauty of tone.

THE "LAUZON" motor and mechanical equipment are of the very highest class and most expensive made.



The Michigan Phonograph Company

Phonograph Division of the Lauzon Furniture Company

OFFICES
705 Ashton Building

GRAND RAPIDS, MICHIGAN

FACTORY
Monroe Ave. and 6th St.

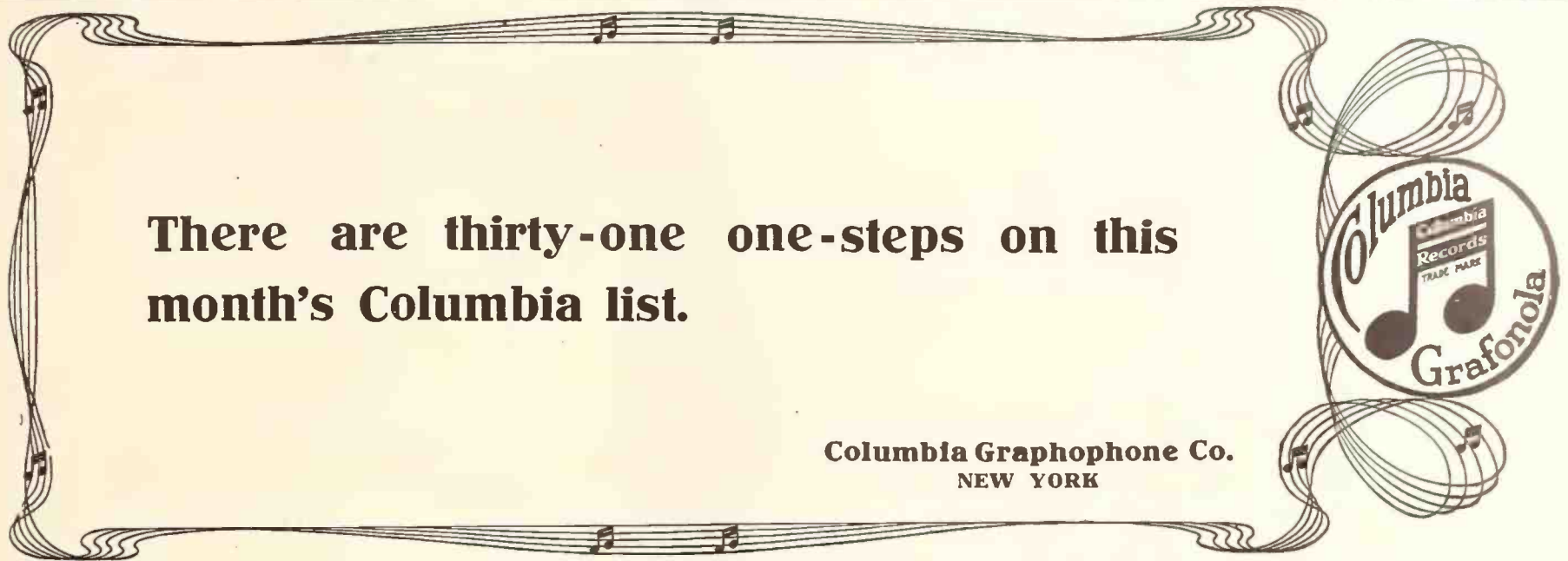

There are thirty-one one-steps on this month's Columbia list.

**Columbia Graphophone Co.
NEW YORK**

of knowledge in music salesmanship, save only when demand, for any reason, goes crazy and swamps a temporarily embarrassed production.

Personal Enthusiasm

Indeed, there is no getting away from the primary argument. The merchant who wants to make a specialized business of the talking machine and its records has simply got to make himself acquainted with the rudiments of music loving if not with music as a science. He simply cannot stimulate the enthusiasm of others if he has none of his own. If he is to create around his business a permanent clientele of intelligent men and women who will buy from him steadily and in preference to going elsewhere . . . and in any normal community specialty retailing depends on this . . . he must feel of himself some of the enthusiasm he aims to create. If he does not love his finest records and the tone of his finest machines then he cannot possibly create any love for them where this does not already exist. If he could always depend upon a circle of buyers thoroughly intelligent in matters musical and capable of choosing intelligently for themselves it would be different. But in this day and age the American public have to be guided and led. How can the blind lead the blind?

The "Best Sellers" Talk

Let it not be supposed for a moment that the list of best sellers, with its overpowering majority of dance and vapid song numbers, represents the backbone of the talking machine game. That backbone is in the growing love of the American people for the highest class records. The history of the greatest talking machine industries shows this plainly. To make money in this business the merchant must sell high-class

records. This means that he must be able to build up around himself a clientele of high-class intelligent music-lovers, who will appreciate the value of the high-priced machine and demand the high-priced artist record. But to do this again the merchant must at least be as intelligent musically as his customers.

These would seem to be self-evident truths but it is surprising how many will argue against them. Yet the history of the business proves that the best salesmen are those who can most intelligently talk about the records, the music, and the points of the machines. The merchant who takes no interest in this matter cannot expect his clerks to be better than himself. If

he is to build up esprit de corps in his business organization and make it something worth while, he must himself show a good example.

That is why I insist that the talking machine dealer ought to make it his business to obtain as complete an acquaintance as he can with the best of the records he carries, with the acoustic principles of the talking machine, and with the subject of music in general from the point of view of an intelligent listener. When he can himself join in with the enthusiasm of an intelligent customer, and be sincere about it, he will have obtained a grasp on the foundations of his business which he cannot possibly get in any other way. Such a man will win out.

PATRIOTIC EMPLOYERS TO BE CITED

Those Who Give Back Pre-war Jobs to Soldiers and Sailors Will Be Permitted to Display the U. S. Shield on Firm's Service Flag

And now there is a citation for the employer—the employer who "makes good on his service flag." With their pre-war jobs filled or offered to between 70 per cent. and 80 per cent. of America's honorably discharged soldiers and sailors. Arthur Woods, Assistant to the Secretary of War, said recently in a letter from Washington that the War and Navy Departments had prepared a citation to be issued to all employers who assure the departments that they will re-employ everybody who formerly worked with them and left to serve in the army or navy.

The citation carries with it permission for the holder to display on his firm's service flag the shield of the United States. It is handsomely engraved, engrossed with the name of the re-

ipient and signed by the Secretary of War, Secretary of the Navy and Mr. Woods.

"All that is asked," Mr. Woods says, "is that the employer write an application for the citation, stating that he will employ his old service men, and address me in care of the War Department, Washington."

DEMURRAGE CHARGE CUT

WASHINGTON, D. C., June 23.—Substantial reductions in demurrage charges were announced to-day by Director General Hines. For detaining cars, either loaded or empty, the charge will be \$2 per day for each of the first four days and \$5 per day for each succeeding day.

The new charges, which become effective July 20, compare with present charges of \$3 per day for each of the first four days, \$6 per day for each of the next three days and \$10 per day thereafter. Heretofore, however, no charge had been made for cars detained for loading.

THE SERVICE THAT HAS PROVEN ITSELF

ECLIPSE **VICTOR**

ECLIPSE

CLEVELAND **EXCLUSIVELY**

THE ECLIPSE MUSICAL CO. - CLEVELAND, OHIO

 A large rectangular advertisement with a double-line border. At the top, it reads "THE SERVICE THAT HAS PROVEN ITSELF". Below this, the words "ECLIPSE" and "VICTOR" are written in large, bold, sans-serif capital letters. In the center, there is a large circle containing the word "ECLIPSE" in white, bold, sans-serif capital letters. Below the circle, the words "CLEVELAND" and "EXCLUSIVELY" are written in large, bold, sans-serif capital letters. At the bottom of the advertisement, it reads "THE ECLIPSE MUSICAL CO. - CLEVELAND, OHIO".

WINDOW DEVOTED TO RECORD OF THOS. A. EDISON'S VOICE



This is the display the Diamond Disc Shop at Albany, New York, put over in honor of Mr. Edison's personal Re-Creation

FINISHES GOVERNMENT CONTRACT

Thomas Mfg. Co. Now Back on Peace Basis Making Motors After "Doing Their Bit" for the Government—Interesting Developments

DAYTON, O., July 5.—When America entered the war for world freedom many of the large industrial plants of this country were either already actively engaged in the production of war material or were quickly enlisted in the work of producing the means that so completely overwhelmed Germany and ended the war a year sooner than had been expected. That the Thomas Manufacturing Co., of this city, manufacturers of the Dayton motor, played an important part in this connection is shown by the fact that during this time they were turning out a very intricate and exceptionally fine part of optical equipment, which was used on artillery and naval gun sights. An idea of the accuracy and close limits to which these pieces were manufactured can be gained from the fact that many of the graduations and distances had to be read with the aid of magnifying glasses.

Just prior to the outbreak of the war the Thomas Co. had installed extensive new equipment for the manufacture of the Dayton phonograph motor and this particular machinery happened to be the only kind capable of producing the necessary accuracy required on this work. Needless to say, almost their entire manufacturing facilities were quickly and intensively employed on this work to the practical exclusion of their regular product. With the coming of peace and the complete release from war production which the Thomas Co. executed with characteristic American energy and patriotism came the return of peaceful pursuits and their return to the exclusive manufacture of Dayton motors, tone arms and sound boxes, with the invaluable experience gained in making some of the most exacting war machinery ever produced. It is also reported that a large special ma-

chine formerly intended to be used in building ignition apparatus for the Liberty aeroplane engine is among considerable new and specially constructed machinery recently installed at the Thomas plant. This machine, it is said, had just been completed when the armistice was signed and is particularly adapted to the fine work required on Dayton motors. This big machine, with others, will have a great deal to do with increasing the output of the factory, and the company now believes they will be in a position to keep pace with orders and the steadily increasing demand for Dayton motors. To facilitate drilling highly developed multiple

ATTENTION

If you are looking for quick service and right prices, get in touch with us on the following lines:

**Q R S Rolls
Emerson 7 inch Disc Records
Wall Kane Needles**

Complete line always on hand

Write for monthly bulletin, catalog and prices

Enterprise Music Supply Co.
145 West 45th St., New York City
MAURICE RICHMOND, Gen'l Mgr.

We are the largest jobbers of sheet music and music books in the U. S.

Save time and money by ordering all your supplies from one house

spindle drills are now used, with which it is possible to drill all holes in a motor frame, including those tapped and reamed, in about 60 seconds. The finish of the Dayton motor has been changed from silver bronze to a combination of polished surfaces and dark green enamel and in its new dress is now being submitted to some of the largest users of phonograph motors in the country for comparison and exhaustive tryouts.

DALIN ENLARGING STORE

Samuel Dalin, head of the S. Dalin Jewelry Co., West Allen, Wis., has enlarged his music store and has added a large stock of talking machines and records.

Automatic Change of Weight



(Patent Applied for)

An Exclusive Feature of
**Parr
Central
Universal
Tone Arm**

The Parr Central Universal Tone Arm marks a new departure in tone-arm construction and removes the principal objection heretofore existing in universal arms. The weight to play either vertical or lateral cut records is automatically and accurately changed. This is a very novel and important improvement in tone-arm construction and should appeal to those who have wanted a tone arm that would not require the makeshift arrangements for doing what this tone arm does automatically. The first scientifically constructed universal tone arm, and the only one having this very important improvement.

OTHER IMPORTANT FEATURES

Length of tone arm required should be specified when ordering.
Needle change is facilitated by rotating sound box, which returns to normal position.
Needle always takes same position in playing any type of record, setting in direct center.
Supplied with either mica or Vibratone diaphragm, but the latter is recommended if superior tone quality and volume are desired.

OTHER PARR PRODUCTS:

Magnetic Reproducer Vibratone Diaphragm
PARR MANUFACTURING CORP.
Main Offices: 100-108 West 23rd St., NEW YORK
Factories: New York City—Latrobe, Pa.

A necessity to all talking machine owners

Adds life and tone. Should be used on all records before playing

"Dustoff" Record Cleaner

Reproducing vocal records natural as the human voice. No scratching or harshness. A seller for 8 successful years. 3 models. 25c, 35c, 50c each. Packed for counter display. Name your jobber. Write for samples.

W. I. SCHWAB, Mfr., 128 No. Main St., Providence, R. I.

ATLAS PACKING CASES

Make Your Responsibility Our Responsibility

YOU must be responsible to your dealers for the condition of your shipments on arrival—a defective packing case not only means financial loss but dissatisfaction to your trade and damage to your reputation as a careful manufacturer.

Insurance against the possibility of damage and dissatisfaction is available and may be had only by placing your packing case responsibilities with reputable and careful packing case manufacturers.

Remember the packing case is all that protects the high quality instrument you manufacture while it is in transit.

“Atlas” 3-ply veneer cases are *quality* cases manufactured in enormous quantities for the highest class trade. “Atlas” cases are made of 3-ply birch and hard maple veneer with clear spruce battens—a remarkable combination—insuring both beauty and strength.

These four thoroughly organized factories are equipped to furnish you with “Atlas” packing cases in any quantity. “Atlas” cases are uniformly of high quality.

Why not make us responsible for your *important* packing case needs?

Nelson & Hall Company

Blair Veneer Company

Richford Manufacturing Co.

Veneer Products Company

Exclusive Selling Agents

**ATLAS SALES
CORPORATION
RICHFORD, VERMONT**

Chicago Office

327 South LaSalle St., Webster Bldg.

“ATLAS”
PACKING
CASES



Carry
the
Weight
Save
Freight

BUSINESS WITH AUSTRALIA GROWS

Prospects Deemed Favorable for the Continued Increase in the Consumption of American Goods—Talking Machines Much in Favor

The trade of Australia before the war was practically divided between England and Germany, with a relatively small amount coming from the United States. This was largely due to the fact, Trade Commissioner A. W. Ferrin at Melbourne points out, that the principal exports of Australia—wool, gold, wheat, meats, hides and skins—were normally exported to the English market. The sympathetic feeling between Australia and America, which has grown up from the war, he explains, will tend to encourage trade between the two countries.

An Australian market for American goods ought to be especially desirable, as the seasons are the reverse of those in the United States, permitting the American manufacturers to make good during the dull season for this trade which has been accustomed to place its orders nine months ahead of requirements. One of the

drawbacks is the question of credits, but Australian bankers realize the situation and are willing to make arrangements with New York banks to pay American manufacturers for their goods upon the receipt of invoices and shipping documents, when properly authorized by Australian merchants who will pay the interest, exchange and collection fees upon terms pre-arranged with the bankers.

Australian merchants feel that while it would be advisable for representatives of American firms to make trips to the Australian market in order to establish connections, local agents could conduct the actual business more satisfactorily, owing to their knowledge of the financial standing of local concerns, of the best time to make shipments and of the grade of goods required.

The exports of American musical instruments to Australia have made great strides within the past few years, and the American piano and player is now recognized as an instrument of superior merit in that country. It is quite evident that the demand during war times will continue, because American musical products have won an established clientele.

ACME-DIE

CASTINGS

ALUMINUM-ZINC-TIN & LEAD ALLOYS

Acme Die-Casting Corp

Boston Rochester Brooklyn N.Y. Detroit Chicago

WON SUCCESS FROM THE START

A. F. Meisselbach, Vice-President of the Otto Heineman Phonograph Supply Co., Is a Veteran in the Talking Machine Industry.

One of the veterans of the talking machine industry is A. F. Meisselbach, vice-president of the Otto Heineman Phonograph Supply Co., Inc.



A. F. Meisselbach

and head of the Meisselbach division at Newark, N. J. He started his manufacturing career some thirty-five years ago when he decided that the fishing paraphernalia of that period was not up to the proper standard. He then perfected an absolutely silent fishing reel which attained success and which was the start of the Meisselbach institution.

Some years ago Mr. Meisselbach went further ahead with his inventive plans and placed on the market the Meisselbach motor, which has received an enthusiastic reception from manufacturers everywhere. About two years ago the Meisselbach motor became an integral part of the Heineman organization and this plant is now known as the Meisselbach division of the Otto Heineman Phonograph Supply Co., Inc.

The factory floor space has grown from 4,500 square feet to 60,000 square feet, but this is only the beginning, for in a few months the home of the Meisselbach plant will be a new \$500,000 plant, with a floor space of over 200,000 square feet.

Trubin Bros., Red Bank, N. J., are building an addition to their store to take care of the increased trade in the music department, especially in the sale of talking machines.

CABINETS and TALKING MACHINES for WHOLESALERS, DEALERS, JOBBERS



We can supply you with high grade talking machines to suit your every need. While we are cabinet makers we also manufacture complete machines,

We have a large stock prepared ready for shipment to meet the requirements of the trade.

Prompt Deliveries

Inquire for Catalog and Price List of

BEN FERRARA
ONEIDA, NEW YORK

NEEDLES

WE MANUFACTURE

Diamond needles for Edison

Sapphire needles for Edison

Sapphire needles for Pathe

in stock ready for delivery

MERMOD & CO., 874 Broadway, N. Y.

Gleanings From the World of Music

NEXT SEASON TO BE A BIG ONE FOR POPULAR MUSIC

Dealers in Talking Machine Records Will Do Well to Watch the Preparations of Music Publishers for Carrying on Strong Publicity Campaigns During Next Few Months

During the coming fall, according to the plans of the leading publishers of the country, some of the largest national advertising campaigns ever inaugurated in the publishing industry will be under way. Not only are the publishing houses that have carried on national advertising campaigns during the past season, and in seasons gone by, going to continue enlarging their plans, but it is now understood that several other large concerns have appropriated substantial amounts of money for this purpose.

It is conceded that the quick profits for the dealer are in the sale of popular songs and dance records. These mean constant sales to the same record buyers each month, and mean constant profit to the dealer. So he should watch closely the plans of the music publishers and jobbers during the fall as well as those of the record company for which he is agent.

National advertising alone does not sell songs. The leading publishing houses of the day have tremendous organizations, with representatives scattered throughout the country in every large city, and these representatives not only put into force plans for the popularization of songs in the city where they have their permanent location, but they also cover all adjacent territory. They see that the professional singers are plugging the songs, while the campaign is on; that bands and especially dance orchestras, feature them, and that practically every theatre and motion picture house features the numbers in their programs. The publishers that go into these large campaigns do it after much planning, and it is very seldom the songs selected to be featured in these big drives are failures.

Then, too, to-day they invariably have the support not only of the record corporations and their jobbers, but also of the music roll cutters, and all these forces, working toward one end, mean record sales for the live dealer.

The sale of songs and instrumental selections in sheet music, record form and in player rolls has greatly increased during the past two years. The music publishers are taking advantage of this, and these advertising campaigns, as now planned, are made for the purpose of caring for the greatly increased popularity of music of all kinds. The more music of all kinds that is sold the more will be sold, and the demands for sheet music and talking machine records during the coming fall will be so much greater than in past seasons that the dealer who does not prepare beforehand will find himself shorter of stock than at any time during the past two years. Consequently, cautioning him to be prepared and to take advantage of these campaigns is with a view to giving him time to stock up.

The greatly increased interest in sheet music has also added to the demand for standard works, and the demand for popular numbers in no wise impairs the salability of standard records. It must be remembered, however, that the popular songs—the songs of the moment—mean quick sales which are repeated with each monthly release, and these are the numbers that are going to be extensively advertised.

Men Who Make Popular Songs

No. 4—Theodore Morse

Probably one of the most successful composers, and one who is well known to the majority of talking machine dealers, is Theodore Morse, who is more frequently referred to as "Teddy." Besides being a successful song writer he is considered one of the best his-



Theodore Morse

torians on musical matters in the country. As pianist with the "Record Makers" he has toured practically the entire country, always working in close co-operation with the talking machine dealers of the towns visited. He is a man of most pleasing personality, and, unlike a good many artists, he is successful in business activities. Among the composers and song writers he is referred to as "the old melody master," this despite the fact that he is apparently a young man. Frequently, when the younger song writers have difficulties in composing a melody to lyrics which do not readily lend themselves to musical composition, they take their troubles to Teddy, and in that manner he has probably been a co-author of hundreds of songs, for which he has neither asked

Everyone SINGS **FIFER SONGS** Everyone SELLS

WONDERLOVE

Waltz—Serenade

a high-class waltz song by Harry D. Kerr and H. Joseph Tandler, of Los Angeles Symphony Orchestra. "I've Got a Little Home in the Country," the natural hit, a lyric and a melody that young and old cannot resist.

"When You're Lonely"—(Won't you come back to me) a syncopated ballad. It prompts a tear and tickles the toe at the same time. Featuring Ruth Clifford—Movie Star.

"Clovertime"—A tingling tantalizing tempo.

"The Only Sweetheart I Ever Had"—a sweet and expressive "mother" song.

"The Busted Blues"—A razzzy-jazzzy funny no money blues.

"Just for a Place in Your Heart"—A popular-priced waltz song of the better sort.

C. ARTHUR FIFER MUSIC CO., Inc.
Quincy, Ill., U. S. A.

nor received credit. He has a long list of songs to his credit, but it is unusual for him to refer to them himself. Among these are: "Blue Bell," "Dear Old Girl," "M-o-t-h-e-r," "Way Down in My Heart, I've Got a Feeling for You," "Arra-Wanna," "Keep a Little Cozy Corner in Your Heart for Me," "Little Boy in Blue," "Sing Me Love's Lullaby," and "Lullaby Blue." This latter number has been a big success during the past season, while "Sing Me Love's Lullaby," is a high-class number which has been sung and recorded by prominent operatic stars, and is without doubt a work which will remain in the standard catalog of the publishers of the song.

SONG WRITERS AND PUBLIC TASTE

Producers of Popular Music Fall Back on Ballads When There is Any Question Regarding Sort of Song Public Wants

When song writers find it hard to discern the public taste or pleasure in popular songs in any one season they always return to ballads. No matter what particular style of song seems to have great popularity at the moment, a ballad always has a fair chance of success, though they are, it is true, much harder to write successfully, and those of a high-class nature are most difficult to make popular. Seldom do such numbers become popular in any one season, and often require campaigns for a period of three or four years before they are finally accepted as big successes.

During the past season ballads which have lent themselves to waltz arrangements were among the most successful numbers produced in the popular and semi-popular field. The Oriental type of song also had quite a vogue, and the "shimmie" numbers, while their life was short, were big successes for a period.

The successful song writer must, if possible, anticipate the public's taste months in advance of the actual publication of his songs, inasmuch as it takes time to place them, and even after acceptance there must be a period of delay. Also the publishers may designate it as one of the numbers to be featured in a campaign with songs of entirely different type. The song writer, therefore, must take all these things into consideration many months in advance. For instance, at the present time most of them are writing for the fall season, and it would be a song of exceptional merit to be published by a popular house during the summer months. From all indications the coming fall will see many ballads of the higher type, especially as regards the lyrics, which are showing much improvement. In the novelty field we will without doubt have quite a vogue of jazz numbers. The song writers appear to feel that this is what the public will want, and most of those who can adopt this style of song are busy.

STERN'S BIG "TEN"

HIT No. 1	"EV'RYWHERE THAT WILSON GOES" Some Roaring Song	HIT No. 6	"I'M GLAD I CAN MAKE YOU CRY" Some Waltz Song
HIT No. 2	"ALL THOSE IN FAVOR SAY AYE" Some Lodge Song	HIT No. 7	"INDIANOLA" Some Novelty Song
HIT No. 3	"WAIT AND SEE" Some Waltz Song	HIT No. 8	"PAHJAMAH" Some Oriental Song
HIT No. 4	"TEARS OF LOVE" Some successor to Smiles	HIT No. 9	"KENTUCKY DREAM" Some High-Class Waltz Song
HIT No. 5	"OH HELEN" Some Comedy Song	HIT No. 10	"MY GAL'S ANOTHER GAL LIKE GALLI-CURCI" Some Wonderful Song

THESE NUMBERS CAN BE OBTAINED IN
RECORD, PLAYER ROLL AND SHEET MUSIC FORM
PUBLISHED BY **JOS. W. STERN & CO.** 105 WEST 38th STREET
NEW YORK CITY

THE A·R·L ATTACHMENT

Makes the VICTROLA a universal machine

Without removing or changing the sound box

So simple a child can attach and operate it.

Remains permanently upon the machine.

Mechanically and scientifically correct.

Plays all types of records in the ONE NATURAL position of the Victor sound box with equal beauty of reproduction.

Protected by patent.

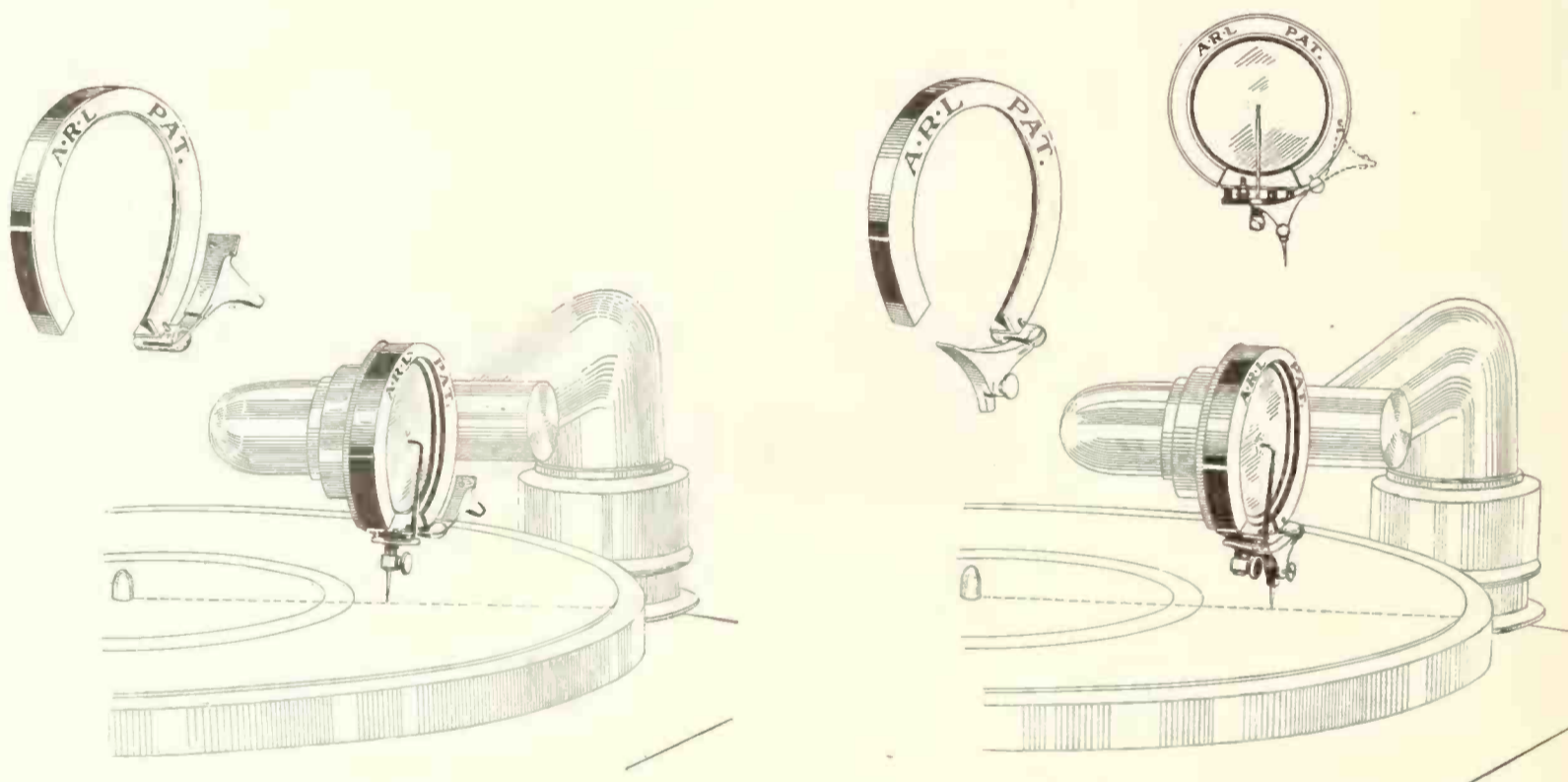

Shows the position of the A. R. L. Attachment when a lateral cut record is being played. Note that the sound box is in its regular position.

Shows the position of the A. R. L. Attachment when Victor is playing hill and dale record. Note that the sound box is in the regular position, and needle on direct line with center. It is scientifically and mechanically correct.

Attachments for Victor Exhibition Box now ready for delivery.

Retails, \$2.00

AMERICAN RECORDING LABORATORIES

56 WEST 45th STREET, NEW YORK

Happenings in Dominion of Canada

TRADE IN MONTREAL PREPARING FOR INCREASED DEMANDS

New Stores Being Opened and Established Stores Enlarged—Some New Products on the Market—Higher Grade Machines Have the Call—Opera Season in Halifax Helps Sales

MONTREAL, CAN., July 7.—Despite the warm weather, which has been intense here for the past few weeks, the retail talking machine business continues to hold its own. Many dealers in fact report a business quite as healthy as that which preceded the Christmas holidays and there appear to be no visible signs of depression or slackening. The greatest demand has been for the larger and more expensive cabinet models sold in large numbers as wedding gifts for June brides.

The Cosmopolitan Graphophone & Piano Co. is the only exclusive Columbia dealer on St. Lawrence Boulevard. L. Foisy, manager, has recently renovated the showrooms and added six extra soundproof demonstrating rooms. The assortment of Columbia Grafonolas is large and a most complete listing of foreign domestic records is carried in stock.

L. G. Fournier & Co., 114-16 Rideau street, Ottawa, Ont., are new Brunswick dealers.

Layton Bros. have been using attractive advertising copy featuring Edison machines and records. A recent announcement was devoted in its entirety to the records of Anna Case and was coincident with the appearance of this famous artiste in Montreal in the photo film "The Hidden Truth." The timeliness of this advertising, coupled with the prominence of this artiste, proved an impetus to the sale of her records.

R. J. Dales, 249 Laurier avenue West, represents His Master's Voice lines in the north end and states red seal records are the prime favorites.

Among recent sales made by C. W. Lindsay, Ltd., Ottawa, branch was a Sonora Grand to a prominent citizen of Hull, Que.

J. J. Flynn has opened newer and larger premises at 556 St. Catherine street West, where one floor is devoted exclusively to the sale of Gerhard Heintzman phonographs and Victor records.

N. G. Valiquette, of N. G. Valiquette, Ltd., one of the most important Pathé dealers in Canada, has secured the services of Albert Bien-jonetti as the head of the music department of his Home Furnishing Emporium.

A. J. Freiman, Ottawa, is now handling the Aeolian-Vocalion phonograph line in addition to other makes featured.

Employees of Layton Bros., Edison and Columbia dealers, recently held their first annual picnic. They chartered the steamer Three Rivers with Lavaltrie as their destination. The warerooms being closed up tight for the eventful day all hands were on deck.

An attractive window display of talking machines more than pays for itself, said Charles Culross, Sonora and Aeolian-Vocalion distributor. Aeolian records, for which he has the sole local distribution, are selling in goodly volume with Sonora needles enjoying immense popularity.

An exclusive Pathé phonograph salon has been opened up at 232 St. Laurier avenue W. under the name of the Phonograph Sales Co. with Hector Garand and Joseph Dumont as joint managers.

The Phonograph Shop of Montreal, Regd., recently demonstrated the Pathé "Actuelle." Manager Geo. S. Pequegnat is most enthusiastic over the sales possibilities of this latest Pathé model.

Brown's Talking Machine Shop (S. H. Brown, proprietor) is well satisfied with the second month's business, June sales in His Master's Voice lines proving most successful. Mr. Brown is looking forward to a good live fall business.

J. B. O'Brien has resumed the management of the talking machine department of C. W. Lindsay, Ltd., Ottawa, after doing "his bit" for a number of years in France.

The Berliner Gramophone Co., Ltd., retail stores are all handling a large quantity of business, both in machines and records, and state that every year sees a heavy increase in the call for the smaller His Master's Voice lines suitable for camping and summer cottages with an enormous demand for dance records.

C. W. Lindsay, Ltd., report no falling off in the demand for Columbia and Sonora machines and Columbia records.

Prattephone, Ltd., St. Jerome, Que., has been incorporated to buy, sell and manufacture talking machines with a capitalization of \$49,000.

The Brunswick Shop is being accredited its

full quota of trade and is more than pleased with the number of machines delivered the past month. It is fully confident that July will far outstrip sales the same month of last year.

Halifax, N. S., has just had a two weeks' season of grand opera by the Boston English Opera Co., which recently played at His Majesty's in Montreal. So successful was the local engagement that the company has prolonged its season and will return to Halifax for the week of July 7. It proved a great impetus for phonograph dealers in the call for records.

The high price received for fish has created an epidemic of extravagance among the fisher-folk along the South Shore of Halifax. They think nothing of paying ten thousand dollars for a house and turn up their noses at cheap cars, preferring high-priced machines, in which they drive grandly to the fish flakes and back again. In Lunenburg alone with a population of three thousand there are nearly two hundred automobiles and four shops specializing in talking machines and pianos, each as busy as can be.

SPIRIT OF ORGANIZATION PERMEATES TORONTO TRADE

Lesson of Co-operation, Taught by War, Not Wasted—Charles R. Leake Deserts Bachelorhood—H. B. Foreman Buys Osborne Phonograph Co.—Goederich Organ Co. Banquets Employees

TORONTO, ONT., July 6.—It is logical that the development of the talking machine industries should generate a series of problems, the solution of which suggests the desirability of organization. One of the effects of the war upon trade has been to force a more general co-operation of those in individual industries. The piano manufacturers are strongly organized. Retailers in the different centers are organized and getting good results in saving money, making more money and educating the public to a decent appreciation of the worth of the people in the music business.

Charles R. Leake, one of the proprietors of the Music Supply Co., distributors of Columbia lines, has surprised those of his friends who had supposed him to be condemned to eternal bachelorhood. Mr. Leake was married recently to Miss Marguerite Eleanor Brandon, niece of the Misses Brandon, of Richard's Landing, Ont.

Harold V. Utting, of Woodstock, Ont., who recently returned after nearly four years' service overseas, has taken up his residence in the city and will join his father, John Utting, in the piano and musical instrument business, 505 Dundas street, Woodstock. While he will identify himself with all departments of the store, his particular branch of the business will be the Grafonola and record department.

A newcomer in music trade circles here is H. B. Foreman, who has bought the business of the Osborne Phonograph Co., opened over two years ago by F. H. Osborne, on Broadview avenue. The Music Supply Co., distributors of Columbia Grafonolas and records, have begun their ninth business year. Their record to date is one of which the proprietors, John A. Sabine and Chas. R. Leake, may well be proud.

Unity of opinion does not exist in the talking machine trade in the question of sending out

records on approval. Some dealers attribute much of the increase in their record sales to the adoption of the records-on-approval plan within certain limits. Others unconditionally oppose the practice.

At a banquet recently tendered the employees of the Goederich Organ Co. by its directors the musical program was furnished by the Royal talking machine, a product of this company's own plant. The occasion was the return of the president, Alex. Saunders, from his trip to Lyons Fair, in France. Following the luncheon a very informing talk on after-the-war conditions in Europe was delivered by Mr. Saunders.

Long before the new Heineman OkeH records had become known in Canada the Canadian buyers of motors and phonograph supplies were well acquainted with the Otto Heineman products. But it took the OkeH records to give the final touch to the great popularity of these products. Since the OkeH record has made its way into Canada's musical homes the Toronto offices of the Otto Heineman Phonograph Supply Co., Inc., are buzzing.

WINNIPEG DEALERS GIVE DINNER

Complimentary Dinner Given to Morgan Kingston, Popular Columbia Artist—Victrola Brought Back From War Front Stood Three Years of War—Buried Three Times

WINNIPEG, MAN., July 5.—A recent regular meeting of the Winnipeg Columbia Dealers' Association took the form of a complimentary luncheon tendered to the celebrated tenor and Columbia artist, Morgan Kingston. The meeting was under the chairmanship of Robt. Shaw,

(Continued on page 144)

Talking Machine Supplies and Repair Parts

SPRINGS, SOUND BOX PARTS, NEEDLES

THE RENÉ MANUFACTURING CO.
MONTVALE, NEW JERSEY

HAPPENINGS IN CANADIAN TRADE
(Continued from page 143)

of Cassidy's, Ltd., Columbia distributors for Western Canada. Among the firms represented were the Winnipeg Piano Co., Cassidy's, Ltd., J. H. Ashdown Co., Banfields, Ltd., T. Eaton Co., the Phonograph Shop, Sargent Pharmacy, Muscovitch Bros. and the National News Co.

John E. White, of the Musical Merchandise Sales Co., has just returned from a trip West, making the principal towns as far West as Swift Current, Saskatoon and Regina. Mr. White came home by way of Chicago, and the Brunswick orders, which the Brunswick-Balke-Collender Co. in the States has yet to fill, speak very well for the coming conditions in the trade.

COVERS A WIDE TERRITORY

Convention of Talking Machine Jobbers Attracts Delegates From Maine to Hawaii

There is nothing narrow about the convention of the National Association of Talking



From Maine to Hawaii
C. B. Snow
of Portland



W. D. Adams
of Honolulu

Machine Jobbers, for despite the fact that only Victor jobbers are eligible to membership these jobbers are scattered all over the United States and its possessions, and few of them fail to

"She was a good old pal" was the touching inscription scratched on a little Victrola IV, which has just come home from the Western Front, by the men who know what it was to have the comfort and tonic of music in the front lines. This Victrola, No. 183091D, was taken overseas by Sgt. R. M. Ross, son of T. H. Ross, the Vancouver music dealer, in February, 1916, and was three times buried in a dugout. The machine is literally "plastered" all over with names of the comrades of Sgt. Ross and the engagements through which they went. One of these, curiously enough, was the name of Signaler Elmer Howes, cousin of E. J. Howes, manager of the National Piano Co., Ltd., Toronto. Elmer Howes lost his sight through a shell bursting in his face and is now in the English St. Dunstan's School for the Blind.

make the annual, or occasionally bi-annual, pilgrimage to Atlantic City to meet the other fellow and talk over business. At the recent convention, for instance, there were jobbers from Maine, and at least one from distant Hawaii. C. B. Snow, for instance, of the Cressey & Allen Co., Portland, Maine, and W. D. Adams, from the Bergstrom Music Co., Ltd., Honolulu. The two gentlemen mentioned are shown herewith. Despite the fact that they live nearly 5,000 miles apart, they are citizens of the same country, speak the same language and everything, including the selling of Victrolas.

PLANNING BIG FALL TRADE

C. W. Neumeister, Assistant General Manager of Otto Heineman Phonograph Supply Co. of Illinois, Tells of Western Activities

Charles W. Neumeister, assistant general manager of the Otto Heineman Phonograph Supply Co. of Illinois, was a recent visitor at the executive offices of the Otto Heineman Phonograph Supply Co., Inc., of 25 West Forty-fifth street, New York City. Mr. Neumeister spoke very encouragingly of the business situation in the West, stating that the demand for Heineman and Meisselbach motors, tone arms and sound boxes was far beyond all expectations. "The talking machine manufacturers in this section of the country," he said, "are preparing for a banner fall trade, and in many instances are making plans to handle a business 100 per cent. greater than last fall. The OkeH record is gaining in popularity throughout the West with each succeeding bulletin.

WALTER S. GRAY'S

JOBBER'S BULLETIN OF PHONOGRAPH ACCESSORIES

The best of everything my policy and the best of service my practice.

Albums; Attachments for Edison Machines to play all records; All in One and plays all attachments to play all Records on Columbia and Victor Machines; Corrugated and Wooden Packing Boards; Diaphragms-Mica; Edison Diamond Points; Edison Sapphire Points; Fibre Needle Cutters; Harmonicas; Lansing Khaki Covers; Literature Hangers; Easels and Monthly Supplement Displays; Monthly Supplement Envelopes; Needles, Steel and Semi-Permanent; Pathé Sapphire Balls; Ready Files; Record Cleaning Brushes, Printed and Unprinted; Record-Lites; Record Stock Envelopes for all sizes Victor, Columbia, Pathé; Reproducers; Record Delivery Envelopes, 11½x11½ and 13½x13½; Seals and Stickers for Envelopes and Packages; Sticker Moisteners; Violin Strings.

WALTER S. GRAY

508-529-530 Chronicle Building
SAN FRANCISCO

CONVENTION OF DOEHLER FORCES

Sales Representatives of Doehler Die Casting Co. Hold Semi-Annual Conference in New York—Some Pleasing Social Features

The semi-annual sales convention of the sales representatives of the Doehler Die Casting Co. was held at the Brooklyn factory on Friday and Saturday, June 27 and 28. A full attendance of the company's representatives from all parts of the country was recorded. Prizes were awarded to the holders of the three highest

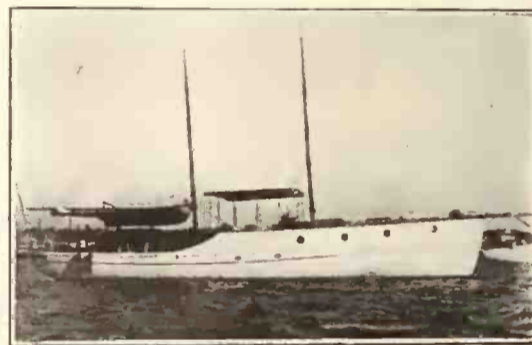

The "Alwilda"

marks established during the six months then ending. The award of prizes of this nature is an innovation on the part of this company and the highly satisfactory results obtained during the past six months warrant the continuance of the practice.

The social end of the gathering was featured by an outing and boating party on Saturday, fathered by H. B. Griffin, general sales manager, as follows:

The party left the factory at Court and Huntington streets at 12 o'clock. Lunch was served at Bensonhurst Yacht Club at 1. The production manager, John Kirkland, was the host of the party on board his handsomely fitted 53-foot launch, the "Alwilda," which left the Bensonhurst Y. C. pier at 2:30, and after a leisurely cruise along the bay landing was made at the Belle Harbor Yacht Club at 6, where an excellent dinner was served, and the return trip started at 7:30, arriving at the starting point, the Bensonhurst Yacht Club, at 9:30, where, acclaiming the trip one grand event, the party disbanded and the 1919 Summer Convention of the Doehler Sales Representatives came officially to an end. It was one of the most enjoyable events of the season.

SEND FOR ILLUSTRATED PRICE LIST AND FREE SAMPLE
"GLOBE" TRANSFER NAME PLATES
DEALERS EVERYWHERE APPLY THEM ON PHONOGRAPHS, PIANOS, ETC.
GLOBE DECALCOMANIE CO.
JERSEY CITY, N. J.

RAMOSOLA PHONOGRAPHS

The Talking Machine With a Soul

Best on Earth. We Prove it by Perfectly Playing All Makes Of Disc Records.

Richmond Made Perfectly Adjusted Machine of Universal Proclivities.

We Have Profited by The Mistakes of Others. The Proof of Our Profit—Look What Happened

To The Blind Typewriter So Will it be with the One School Machine and The So-called Universal.

Thirteen Models. Write for Trade Discounts. We also Job the Quality Line of Motors, Tone Arms and Records

We mean OkeH Records, Heineman Motors, Meisselbach Tone Arms, Cleartone Needles.

Ramos-Eubank Phonograph Mfg. Co.

The South's First Phonograph Manufacturers

P.O.Box 1354 104 N. 7th Street Richmond, Va.



The Columbia Supplement this month contains six chapters on dance music—and all the dances.

**Columbia Graphophone Co.
NEW YORK**



TO CONDUCT HEINEMAN RESEARCH

John J. Scully, Long in Talking Machine Industry, Becomes Head of Experimental Laboratory of Otto Heineman Phonograph Supply Co., Inc., New York

The Otto Heineman Phonograph Supply Co., Inc., New York, announced this week the appointment of John J. Scully as manager of experimental laboratory with headquarters in New York.



J. J. Scully

Mr. Scully will have complete charge of all of the company's research and experimental work, and his previous experience admirably equips him for this important post. John J. Scully was associated with the Columbia Graphophone Co. for the past thirteen years, and since 1917 has been supervisor of the company's experimental and mechanical laboratories. For four years he was intimately associated with F. H. MacDonald, a pioneer in phonograph development, and during this period Mr. Scully acquired a thorough technical knowledge of the mechanics of this industry.

Mr. Scully has designed apparatus required for special adaptations of the phonograph, and in addition invented several labor-saving devices. He therefore brings to his new position

an invaluable experience that will be at the disposal of the Heineman organization and clientele, and which will undoubtedly prove a tremendous advantage to every user of Heineman products.

TO ESTABLISH WESTERN OFFICE

D. Bartelstone, of Lucky 13 Phonograph Co., Makes Western Trip in Connection With Important New Distributing Arrangements

D. Bartelstone, president of the Lucky 13 Phonograph Co., New York, made a trip to Chicago and some of the larger trade centers in Canada during the early part of this month. Before leaving Mr. Bartelstone made no definite statement as to his plans, but it is understood that some Western interests were very anxious that he make the trip. It is reported that the company have made tentative arrangements for a Chicago office and announcement of their location is looked for shortly. The Lucky 13 Phonograph Co. have been closing a large volume of business in the West and the above move is being made to give greater care, if possible, to orders from that territory.

David R. Doctorow, general manager of the company, who was recently discharged from the United States Army, after distinguished service in France, has again returned to his duties. Mr. Doctorow is a well-known motor expert and besides the above connection he is interested in several machine tool companies. He contemplates making a trip in the near future visiting the trade in various parts of the country and getting in touch with trade conditions.

DELIVER PHONOGRAPH BY AIRPLANE

Edison Machine Carried Through the Air From Kansas City to Sedalia, Mo.

SEDALIA, Mo., July 5.—The delivery of an Edison phonograph by airplane is a feature just accomplished here through the enterprise of W. M. Hinde, of the Sedalia Music Shop. The instrument was placed in the airplane by The Phonograph Co., Kansas City, and was carried through the air to the Missouri State Fair Grounds near this city, Samuel Pickard, a veteran army flyer, piloted the machine, and although delayed and forced to land once by mechanical trouble, he succeeded in continuing his flight and reached the Fair Grounds without further mishap. The Edison phonograph stood the trip perfectly, and when landed was able to turn out the jazziest of jazz tunes without delay.

After the machine had been delivered, Mr. Hinde got into the plane, and flew over the Fair Grounds and the city, throwing out large quantities of handbills telling of the new airplane phonograph delivery. Mr. Hinde ended his flight in safety, but when the aviator attempted to take up the next passenger the machine crashed into a tree and both the aviator and his passenger were seriously but not dangerously injured.

Before purchasing the Sedalia Music Shop, Mr. Hinde was connected with The Phonograph Co., of Kansas City, as district manager. His enterprise and the successful manner in which the affair was carried off won columns of free reading matter in the local newspapers.



Eight Models
Retailing from \$30
to \$275

SONA-TONE

"The tone you can't forget"

The Phonograph that is making Piano and Violin Records Famous. No better constructed and equipped instrument—with a tone not equaled by any. We invite your critical investigation.

Jobbers and Dealers in open territory solicited. Write for catalogue and terms.

*Sona-Tone Steel Needles and Jewels
are the Best on the Market*

SONA-TONE PHONOGRAPH, Inc.
110 West 40th Street
New York City

DISTRIBUTORS AND EXPORTERS

W. REED WILLIAMS, INC.,
160 Broadway, New York City.

HANDELMAATSCHAPPY "TRANSMARINA," INC.,
62 William Street, New York City.

WILLIAM A. MURDOCK, 744 No. 41st St., Philadelphia, Pa.

GEORGE A. CALDWELL, 808 Blue Hill Ave.,
Boston, Mass.

WILLIAM FISHER & COMPANY,
200 Broadway, New York City, and San Francisco, California.

SONA-TONE DISTRIBUTORS CORPORATION,
322 Livingston Street, Brooklyn, N. Y.

DE VAUSNEY & TAYLOR, 512 Orange St.,
Newark, N. J.

VAN WIRT & BROMLEY,
Fairmont, W. Va.

SONA-TONE MUSIC COMPANY,
Glens Falls, N. Y., Hudson Falls, N. Y.

INCREASE FACTORY EQUIPMENT

Peerless Album Co. Installs New Machinery in Order to Handle Growing Demands

The Peerless Album Co., New York, manufacturers of record albums, has, during the past two months, added greatly to the equipment of its plant. The new machinery installed adds to the efficiency of the plant as well as to the production of albums.

Philip A. Ravis, president of the company, takes personal interest in the processes going into the making of the completed albums and great care is taken in every department to make



Embossing and Finishing Department

the finished product of the highest standard. Herewith is shown some reproduced photographs of the embossing, and the finishing and packing departments. The albums pass through a series of examinations during the course of their manufacture and the examination just prior to packing is the most thorough of all.

The demand for record albums is constantly growing and the officers of the above company



Packing Department

state that it will greatly increase during the coming fall. They look forward to a period of great prosperity in the album field and are making every effort to prepare themselves for the added sales.

BULK SALES LAW IN PENNSYLVANIA

Through the activities of the Pennsylvania Legislative Committee of the Credit Men's Association, there was passed at the last session of the Pennsylvania Legislature a bulk sales bill which supersedes a law which had been found insufficient. The new act goes a step beyond the Michigan statute, which has usually been regarded as a model. It imposes in addition certain clear obligations on the vendee if the sale in bulk is to be legal. Business men should become acquainted with its provisions.

REPAIRS

All Makes of Talking Machines Repaired Promptly and Efficiently

ANDREW H. DODIN

176 Sixth Avenue New York

TELEPHONE, CHELSEA 8437

SOSS
INVISIBLE HINGES

Fine cabinet work has always demanded that hinges be as inconspicuous as possible.

Soss Hinges are Invisible

They are therefore ideal for beautiful cabinet work as the preservation of the beauty of unbroken lines in better grade cabinets is thus insured.

The leading manufacturers of the industry use Soss Hinges.

Soss Hinges are so accurately made and so easy to install that they save time and labor, as all mortising can be done by machine.

SOSS MANUFACTURING CO.
GRAND AVE. AND BERGEN ST.
BROOKLYN, N.Y.

NEW PRINCIPLE INVOLVED

Copper Process Co. Announce Tone Arm Made Along New Lines That Interest

What is claimed to be a tone arm manufactured under new principles has recently been put on the market by the Copper Process Co., of New York City. The basic principle in the manufacture is copper plating on a core which has the shape of the tone arm desired. After the plating is of proper thickness the core is removed and the finished product without a seam is the result. The advantages claimed by the manufacturers are as follows: "The standard of production is obtained, for the same core is used no matter how many tone arms are produced. There are not as many separate pieces in a tone arm so constructed. The execution

of more graceful lines and curves may be made and a practically limitless field of design may be carried out by this process of manufacture. The finished product, being made of copper, is practically unbreakable and has a much better surface on which to plate either with nickel or with gold. The plating generally has a much higher luster and is not subject to the usual peeling. The acoustic properties of the tone arm are claimed by experts to be much better when copper is used. Due to the method of manufacture samples for prospective buyers can be made at reasonable prices and in order that the proper service with the trade may be had the company announces that a corps of its experts on tone arm construction are at the disposal of the trade. Production is practically unlimited."

In summertime place orders for holiday trade.

GOLD PLATING of **Tone Arms, Sound Boxes and Phonograph Parts**
OUR SPECIALTY
PRICES QUOTED ON REQUEST

Cliff Manufacturing Works, Inc. 20-22 JACOB STREET
NEW YORK CITY



TEN INCH

Operaphone

Play on all Phonographs

Records

COMPLETE CATALOGUE SENT ON REQUEST
OPERAPHONE CO., INC., LONG ISLAND CITY, N. Y.



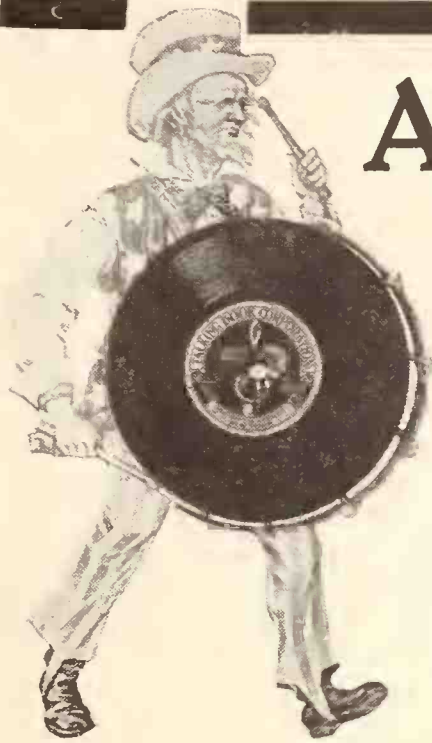

Any Kids in Your Town?

JUST think what a wonderful additional market they offer to you! Just think what an enormous buying power they represent through their fathers and mothers, aunts and uncles, **IF** you have the right article!

TALKING BOOKS

—are the right article. They are making a tremendous hit with America's children. They are *selling*—in music stores, in department stores, in drug stores, in toy stores—selling wherever children are, and that's everywhere.

THREE BIG FEATURES

1. They advertise your store— because the kids want them, and bring their mothers and fathers in to get them, and then you sell them other records from your regular stock.

2. There is no dead stock— Every Talking Book is standard. The mocking-bird's song is the same next year as this year. And there's a new crop of kids every year!

3. There is no breakage— Talking Books are a new invention, containing unbreakable records, and little Jimmy can carry them along to bed, drop them on the floor and "treat 'em rough" without damage.

Fine for dressing your windows, because they're novel in appearance, contain pictures and are beautifully colored.

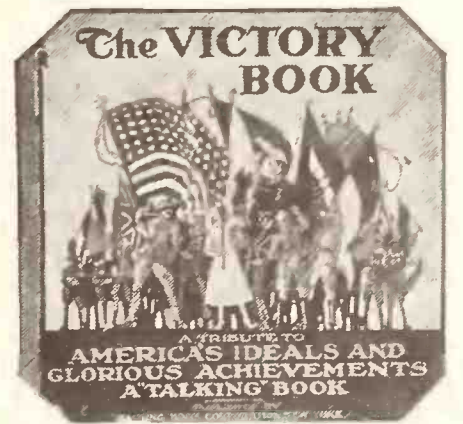

Profit Takers

The shrewdest buyers of the country are the keenest advocates of Talking Books.

Here are a few out of many who have opened Talking Book departments, with window displays, local advertising and big results in profits:

- John Wanamaker, Philadelphia, New York
- Marshall Field, Chicago, Ill.
- J. L. Hudson Co., Detroit, Mich.
- La Salle & Koch, Toledo, O.
- Hallet & Davis, Boston, Mass.
- R. H. Macy & Co., New York City
- Scruggs, Vandervoort & Barney, St. Louis, Mo.
- Joseph Horne & Co., Pittsburgh, Pa.
- Lord & Taylor, New York City
- H. & S. Pogue & Co., Cincinnati, O.

Don't miss another day of your Talking Book profits!

Be the first in your territory to cash in!

Dealers' discount 1/3 off and over, according to quantity. Attractive display material goes with your shipment.

Send in your order to-day.

TALKING BOOK CORPORATION

1 West 34th St., New York
AT-FIFTH AVE.

TALKING BOOK CORPORATION
Western Division
608 So. Dearborn St.,
Chicago

Exclusive Export Distributors
EMERSON INTERNATIONAL, INC.
180 Broadway, New York City

New Issues Every Month

This is a partial list of heavy sellers:

- The Mocking Bird...25 cents
- The Talking Parrot...25 cents
- The Roaring Lion...25 cents
- Uncle Sam25 cents
- The Dancing Girl...25 cents
- The Tired Baby.....25 cents
- The Little Hieland
Mon25 cents
- Watermelon Coon...25 cents
- The Tiger Hunt.....25 cents
- The Battle of the
Marne50 cents
- The Submarine
Attack50 cents
- Mother Goose\$1.00
- The Victory Book..... 1.50
- Twilight and Dawn
in Birdland..... 2.00

Send for complete illustrated catalog.

TALKING MACHINE DEALERS HOOKING UP WITH MUSIC

Talking Machine Dealers Find It Profitable to Watch Campaigns of Music Publishers and Arrange Their Local Campaigns in Accordance With Such National Advertising

During the past few seasons music publishers, particularly the publishers of popular music, have gone into national advertising in a big way, and have served to bring their latest issues

to the attention of the public through the magazines and follow-up advertising simultaneously in all sections of the country. Moreover, the publishers in their advertising have come to recognize the fact that a goodly proportion of the public secure their popular music through the medium of player-piano music rolls and talking machine records, and have made special mention

of the publishers, and hooking up their own advertising with those campaigns as far as possible, there was offered an opportunity for increasing materially the sales of records. Through the medium of special posters and special window displays there has been much done along this line, an example of associating the record with the sheet music being presented herewith in the reproduction of an attractive window display of "Chong" in Meek's Music Store, Wilson avenue, Chicago.

It is understood in the fall music publishers will inaugurate publicity drives on a larger and more extensive scale than ever before and it would seem that the live talking machine dealer should look forward to these campaigns and take advantage of the opportunity they give him in featuring and disposing of record hits.

NEW LINE OF MACHINES GOING WELL

Franklin Phonograph Co. Producing Ten Attractive Models of Machines

PHILADELPHIA, PA., July 1.—The Franklin Phonograph Co., Tenth street and Columbia avenue, this city, who presented their line of talking machines to the trade at the first of the year, report that their various models have proven very popular. The line now consists of ten models, eight being of the upright type and two table models. Excellent production facilities are available and the distinguished feature of the line is the tone quality and cabinet work. Territory is now being awarded to dealers throughout the country. One of the sales policies of the company is to deal direct with the dealer.

Harrison F. Thornell, well known throughout the talking machine trade, and formerly sales manager of the Bliss Reproducer, Inc., is now connected with the Franklin Phonograph Co. as general manager.

F. K. Pennington, assistant general sales manager of the Columbia executive office, is at present in Chicago in connection with business.



Featuring the Sheet Music With the Records

to the attention of the public through the magazines and follow-up advertising simultaneously in all sections of the country. Moreover, the publishers in their advertising have come to recognize the fact that a goodly proportion of the public secure their popular music through the medium of player-piano music rolls and talking machine records, and have made special mention

of the fact that their popular hits could be obtained in those forms. Talking machine dealers and jobbers, many of them, have realized that in watching the cam-

Build for the Future

A Record of Superior Tone Quality



Immediate Shipment of ALL Popular Songs and Dances

The OkeH Record dealer has an opportunity to build up and develop a permanent and profitable record business, for OKEH RECORDS are definitely established as the most successful hill and dale record in the trade.



Liberal dealer discounts are included in our dealer plan. WRITE.

REID LAWSON, Inc.
OkeH Jobbers

519 First National Bank Bldg.
BIRMINGHAM, ALA.

BIG REDUCTION IN LIST PRICES OF RED SEAL RECORDS

Victor Co. Announces That Records by Such Artists as Caruso, McCormack, Gluck, Kreisler, Heifetz, Etc., Will Be Retailed at Half Former Prices—The Democratization of Music

An announcement of unusual importance and interest not only to Victor dealers, but particularly to music lovers and the record-buying public, was made by the Victor Co. through the medium of large advertisements in the daily papers on July 10, when it was stated that there had been a general reduction made in the catalog prices of Victor Red Seal records, the reduction approximating 50 per cent.

As a result of the new departure the records of such famous artists as Caruso, Galli-Curci, Farrar, Gluck, McCormack, Melba, Culp, Heifetz, Paderewski, Kreisler, Scotti, Sembrich and a host of others may be purchased by the public at prices ranging from \$1 to \$1.50, instead of \$2 to \$3, as formerly. Quartets and concerted numbers formerly listed at \$4, \$5 and \$6 may now be obtained at just half those prices.

Informal announcement of the new move was made at the jobbers' convention at Atlantic City and aroused widespread enthusiasm, it being the general belief that with Red Seal records selling at prices usually asked for records of popular songs of the day the demand for good music and the recordings of the great artists will be stimulated to a tremendous extent. Victor wholesalers were quick to apprise their dealers of the contemplated move, and the live retailers for their part lost no time in acquainting the public with the fact that reduced record prices were in effect at their particular stores, with suitable stocks to draw from. Frederick Loeser & Co., of Brooklyn, for instance, ran a big ad on the same day as the Victor announcement appeared, calling attention to the cut-price ruling and offering a substantial list of the most desirable records by leading artists available at the Loeser store at the new prices. Other retailers in various sections of the country likewise made quick capital of the new departure.

The talking machine is acknowledged to have accomplished tremendous work in acquainting the general public with the best in music, even with Red Seal records selling at the old prices. Now that they are obtainable at such a moderate cost they should prove even a greater factor in the general advancement of music interest in this country.

MUSIC AIDS AMERICANIZATION

President of Takoma Park Community Chorus Outlines Value of Music to Our New Citizens—Music Brings All Together, and It Helps Teach Foreigners Our Language

"The alien finds it hard to understand the average American's lack of true appreciation for music and frequently we overlook the opportunity to express to these newcomers America in terms of musical beauty," declares Mrs. Mary Louise Townsend, president of the Takoma Park Community Chorus, of Washington, D. C.

"Now, of course, music has an important place in American life, so large that we spend close to \$700,000,000 annually for it, but it has not yet been so interwoven with the life of the people in any such measure as it is found to be in other countries. Most of our immigrants are from lands where music has long been recognized as a nationalizing force and used as such and these people come to us full of the music of their native land. Naturally, their impulse has been on arrival here, not finding music freely provided by the Government, to gather at once into societies of their own people, thus keeping alive through music and language the spirit and love of their native lands.

"If these newcomers could be gathered as quickly as possible after they come to our shores

into community singing classes in English, several good influences would be set at work. In the first place, music would make these aliens feel more at home and would lessen their longing for the land they left behind. Time and time again it has been the testimony of immigrants that their chief reason for homesickness in America was the lack of music.

"In such community classes they would come in contact more quickly with our American citizens, for there is nothing like music to bring together people of differing nationalities and promote them in comradeship and a feeling of unity. Music is the one universal language for high and low, rich and poor, and people of every race and tongue. Would it not seem, then, to be a most potent factor for unifying the people of a democracy?

"Music would aid the foreign born to learn English readily. The association of the new language with a form of recreation and inspiration, which they already love, will do much to stimulate their affection and patriotism for the new country.

"Musical training, especially in groups, helps physical strength, unity of effort, obedience to leadership, self-control, and enthusiasm in a common cause. Through community singing in English, leading to community centers, our foreign-born element could be brought in direct touch with the Federal Government, and their education for citizenship could be inaugurated under auspices such as could not well be kindled by any other process. It unquestionably is the logical move."

TO OPEN STORE IN NEW YORK

Morris Brickner, who for some time past has conducted a retail talking machine store on Sutter avenue, Brooklyn, has arranged to move to Manhattan and expects to open a new store at 1681 Madison avenue, about the middle of the month. He will deal in Columbia Grafonolas and records, sheet music, musical merchandise, etc.

Remember—

ALBANY
"for capital service"

ON

RED SEAL RECORDS

*This Map Shows Our
 Exceptional Shipping
 Facilities*



*Seven Railroads
 Two Barge Canals
 One River*

FROM US TO YOU

THE GATELY-HAIRE CO., Inc.

Victor Distributors

121 N. PEARL ST.

JOHN L. GATELY, Pres.

ALBANY, N. Y.

IMPORTANT NOTICE

TO THE

AMERICAN TRADE

The Sterno Manufacturing Company
19 CITY ROAD LONDON, E. C. ENGLAND

Manufacturers of the world known COMPACTOPHONE—the most complete portable gramophone extant—beg to announce the conclusion of arrangements for the EXCLUSIVE SELLING RIGHTS IN THE UNITED STATES OF THE

High Grade Motors Manufactured By **Mermod Freres** St. Croix Switzerland

WONDERFUL MECHANISM

These motors represent the acme of workmanship and quality. Each part is made to the finest gauge limits and assembled to run with the precision of a watch—silent and true. Messrs. Mermod Freres is an old established Swiss manufacturer. Back of their motors are years of hard practical experience. The experimental stage was left behind a decade or more ago. Reliability and quality is therefore assured.

DIFFERENT MODELS

Mermod Freres motors comprise several types—single and double spring worm and pinion-gear drive, the very latest and scientific method of construction.

CONSULT US

Before placing your orders elsewhere consult us as to prices and terms of trading. We are out for quick shipments and prompt delivery direct from the factory to the buyer.

SPECIAL TERMS TO JOBBERS

Within the near future it is proposed to establish
A CENTRAL DISTRIBUTING DEPOT IN NEW YORK
Meanwhile trade enquiries should be directed to

THE STERNO MANUFACTURING CO.
19 CITY ROAD LONDON, E. C. ENGLAND

NEWLY ELECTED OFFICERS OF JOBBERS' ASSOCIATION

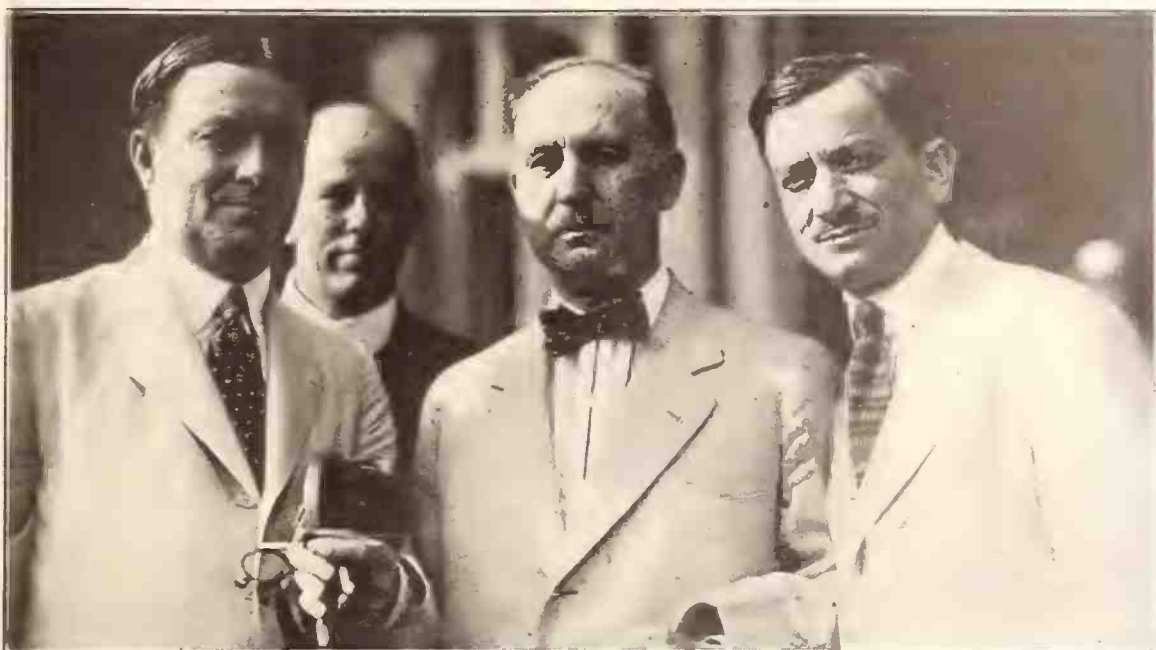

Left to Right—Thos. H. Green, Vice-president; W. H. Reynolds, Treasurer; Geo. E. Mickel, President, and Arthur A. Trostler, Secretary

“THROUGH THE NEEDLE’S POINT”

The following poem from the Irish News, Belfast, is self-explanatory and needs no comment other than to say that the budding genius who composed it must have been quite familiar with the Muse. It is called “Through the Needle’s Point,” and has been utilized to good purpose by Thos. E. Osborne, the prominent talking machine man of that city:

No tongue I have, no hands, nor yet a voice,
Yet talk, or sing, or play which is your choice.
There is no instrument that you can name
I am not mistress of; 'tis all the same,
With song, I sing untiring, with the purest tone,
Soprano, Alto, Bass, or Baritone.
All languages are mine; with wondrous skill
I talk, weep, laugh, and will your senses thrill

With stirring scenes from playwrights, comic, tragic,

All bow in turn to my resistless magic.
Music and song my captives, sound my throne,
I reign supreme, their Queen,

THE GRAMOPHONE.

TO REPRESENT EJECT-O-FILE CO.

The Bliss Reproducer Co., 80 Fifth avenue, New York, manufacturer of the Bliss reproducer, and sales agent for many successful accessories, has been appointed selling agent for the products of the Eject-O-File Co., High Point, N. C. This filing system has met with phenomenal success, and the Bliss Reproducer Co. contemplates instituting an advertising campaign that will produce gratifying results.

GRAFONOLA PRICES INCREASED

New Price Schedule on Machines to Be Put Into Effect by Columbia Co. on July 15

The Columbia Graphophone Co. has sent out to the trade a notice to the effect that a new schedule of prices on Columbia Grafonolas has been devised, representing a slight increase, and will become effective on July 15. The statement as issued by the company reads:

“Effective July 15 and on all deliveries after that date, the prices of Columbia instruments will be as follows:

A-2.....	\$25.00
C-2.....	50.00
D-2.....	75.00
E-2.....	100.00
F-2.....	115.00
G-2.....	125.00
H-2.....	140.00
K-2.....	200.00
L-2.....	250.00

“Our company has absorbed all Government taxes and adhered to lower prices up to this time, with the hope that a more normal cost condition would prevail after the war. We find on the contrary that labor and material costs are advancing so rapidly and to such an extent that higher prices are imperative.

“We feel confident that dealers will welcome this advance in price, in order to help cover their increased operating expenses.”

ALBERT SPALDING TO WED

Announcement was made this week of the engagement of Miss Mary Vanderhoef Pyle, of New York and Bernardsville, N. J., and Albert Spalding, one of America’s most famous violinists, whose recordings are represented in the Edison list, and who has just returned from service in the United States air forces in Italy.

Miss Pyle is a daughter of Mrs. William Scott Pyle, 375 Park avenue. The wedding will take place soon.

INCREASE YOUR INCOME WITHOUT INCREASING YOUR EXPENSE

A line of small goods will bring about this happy result.

Let us help you to select a representative stock of

- VIOLINS
- GUITARS
- BANJOS
- VIOLIN BOWS
- MANDOLINS
- BANJO-MANDOLINS
- VIOLIN TRIMMINGS
- UKULELES
- TENOR BANJOS

ACCORDEONS—HARMONICAS—DRUMS

and all their accessories

Send for our latest catalog
Or write us for further particulars



Sole Distributors of the Famous
S. S. STEWART LINES

Buegeleisen & Jacobson
Union Square
New York City

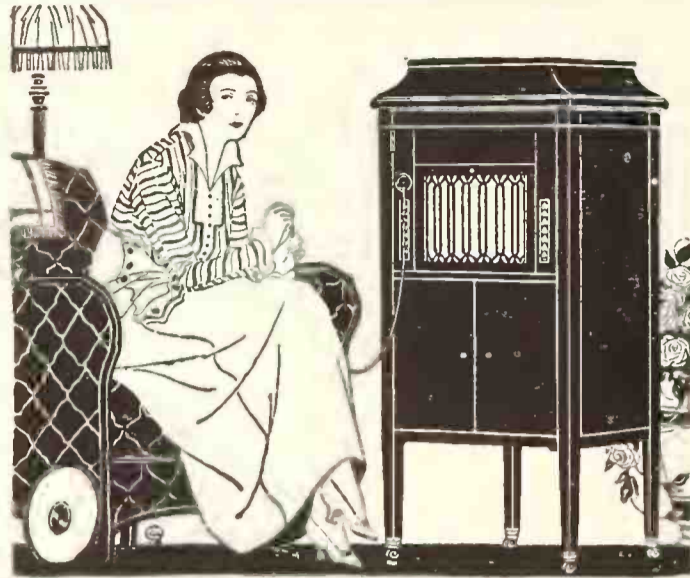

Distribution and Service for the
AEOLIAN-VOCALION
and
VOCALION RECORD

The Aeolian Company of Chicago
529 South Wabash Avenue

(wholesale only) is equipped to supply the trade with instruments and records and to furnish complete advertising and other branches of service.

THE establishment in Chicago is a branch of The Aeolian Company in New York. Dealers will appreciate the advantage of direct contact with the manufacturers whose vital interest in the sales promotion of their goods is obvious.

Aeolian Service is famous in the music trade. Coupled with the recognized supremacy of the Aeolian-Vocalion and Vocalion Record it makes rep-

resentation of these goods the most valuable franchise in the phonograph industry.

The advertising service furnished dealers includes newspaper advertisements, window cards, store hangers, booklets, etc. The newspaper advertisements are prepared to enable the dealer to tie up his local advertising with the powerful campaign of Vocalion publicity in the Saturday Evening Post and other mediums.

Address all communications to

THE AEOLIAN COMPANY

529 South Wabash Avenue, Chicago, Ill.

TRIBUTE TO "JIMMIE" BOWERS

"JIMMIE"

Ten months have passed—how time has sped!
'Twas then you passed the gate;
Then that you left the life you'd led
For one ruled o'er by Fate.

Again you came to bid us cheer,
We men, too young to go,
You spoke as oft you've spoken here,
In deepened tone, and slow.

We found you changed but little, Jim—
Your "vocab" was just the same,
And though you had disabled limb
Your thoughts were far from lame.

We'll honor you—you've done your part
Throughout the darker hours,
For well we know that soul and heart,
You're a Culver man, Jim Bowers.

The above is a poem which recently appeared in "The Vedette," the official newspaper of Culver Military Academy, and was written in appreciation of the heroic fighting done by James Bowers, son of the president of Lyon &

Healy. It should be added that "Jim" Bowers, Jr., is slowly but surely recovering from the very severe wounds he received while in service overseas.

\$2,500,000 INCORPORATION

The Talking Book Corp. has been incorporated with a capital of \$2,500,000 by George P. Read, Albert G. Carlisle, G. Franklin Stringer, all of New York. Robert Foreman, of Montclair, N. J., is also one of the incorporators of the new enterprise.

INCREASING PRODUCTION PLEASES

C. F. Bruno, of C. Bruno & Son, Inc., Victor wholesalers, New York, spent some time at the Victor factory at Camden after attending the convention at Atlantic City. He expects a continuous growth in the monthly production of Victor merchandise and is very enthusiastic over the present fine conditions in the trade and the bright future ahead.

MEMBERS OF PROSPERITY CLUB

W. H. Bagshaw Co., Lowell, Mass., Come Out for "America First"

The W. H. Bagshaw Co., the prominent talking machine needle manufacturers of Lowell, Mass., are sending out in their correspondence attractive cards printed in the national colors and announcing that they are members of the Prosperity Club, with the slogan "America First." The text of the card itself is full of force and reads:

"We stand for action! We believe he who hesitates is lost—that 'sitting tight' means a losing fight—that the man who waits to see how things turn out will always be waiting—that prosperity is the wage of confidence.

"We fear nothing but doubt, hate nothing but idleness, dislike no one but the business man who expects to sell, but won't buy.

"We demand American goods made by Americans, ask fair prices, give good value, and offer live, active service.

"A belief in the above makes you a member. A distribution of that belief makes you an active member. Will you join us?"

R. F. BOLTON RETURNS

Sales Manager of Columbia Co.'s International Record Dept. Brings Back Good Trade Reports

Last week R. F. Bolton, sales manager of the international record department of the Columbia Co., returned from a trip covering many of the Western branches of the Columbia Co. On his trip, which began the 9th of June, he visited Buffalo, Toronto, Detroit, Chicago, Indianapolis, Omaha, Kansas City, St. Louis, Cincinnati and Cleveland. Throughout his trip Mr. Bolton found that there was an increased desire among the general public to obtain foreign language records. He expressed the belief that from the outlook which he gained while on his trip foreign records were going to enjoy a patronage much larger than ever before in the coming months.

BUY FACTORY IN EAU CLAIRE, WIS.

The Multitone Mfg. Co., Eau Claire, Wis., has purchased the four-story factory building of the Eau Claire Trunk Co., acquiring about 22,000 square feet of floor space. They plan to equip the building for the manufacture of Multitone talking machines and will occupy it in the early fall.

TO MANUFACTURE BOOTHS

The Lemar Mfg. Co., Saginaw, voted to increase its capital from \$25,000 to \$250,000, for the purpose of manufacturing and building talking machine booths. M. A. Carpell, formerly with the Herzog Art Furniture Co., is sales manager of the company.

INCORPORATED IN PORTLAND, ME.

William L. Luce, Inc., Portland, Me., has filed articles of incorporation to deal in talking machines and allied instruments. William L. Luce is president and secretary, Robert M. Pennell clerk, and these, together with Charles D. Luce, constitute the board of directors.

MASTER WAX

We are now prepared to make limited quantities of master wax from two formulae. One is especially soft for lateral recording and the other is for vertical recording.

This company has been completely reorganized and desires to make contracts with a few concerns for the next six months' output, as the raw materials are rising in price daily. Samples submitted. Quality guaranteed.

MASTER WAX COMPANY
MILBURN, N. J.

**The Bubble Books
Irresistible Business Builders**

THE Bubble Books are the quickest selling, most profitable novelty in the talking machine field. Lure the children to your store with these enchanting little volumes, and they will take you right into the heart of the family. When a youngster has bought one he always comes for more.

Cash in on a Million Sales

We are helping you. A smashing advertising campaign in the leading journals of the home, beginning early in the Fall, will bring a live demand right to your counter—the children and their parents.

We will run large space in such dominating magazines as Ladies' Home Journal, Good Housekeeping, Vogue, Vanity Fair, Life, St. Nicholas, Red Book, Harper's, Scribner's, Century, Review of Reviews, John Martin's Book.

**NINE BOOKS NOW READY—NEW
ISSUES ALMOST EVERY MONTH**

Retail \$1.00 each

Write for discounts, terms and circular matter, and order through your regular channels or direct from us—**HARPER & BROTHERS,** Franklin Square, New York.

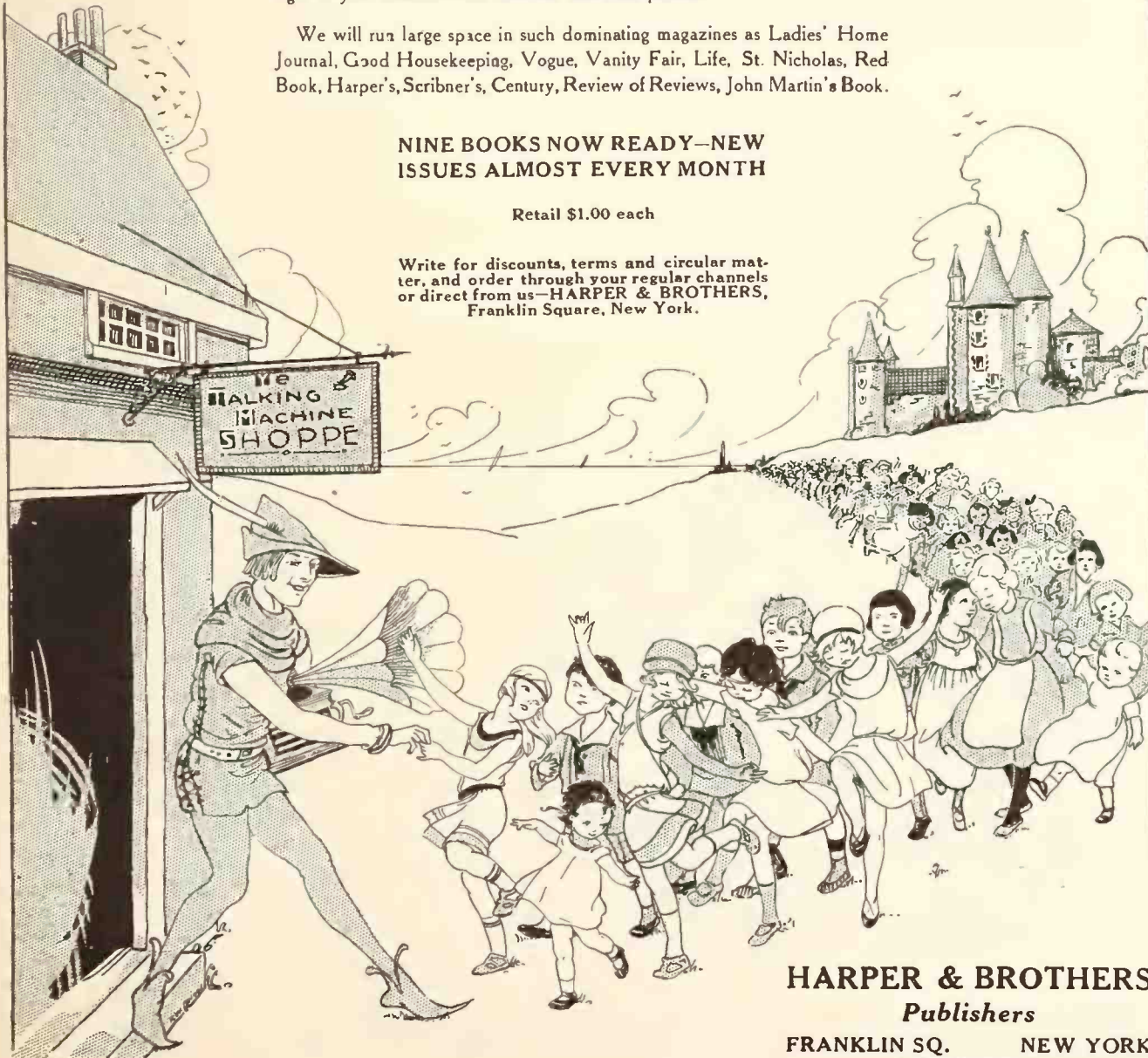

HARPER & BROTHERS
Publishers
FRANKLIN SQ. NEW YORK
Established 1817

You Ought to Know

In case you are contemplating expanding the sphere of your business to include departments devoted to Pianos, Player-Pianos, Musical Merchandise or Sheet Music, that you'll find news and comments about them all in



ESTABLISHED 1876

The oldest and leading music trade weekly, which covers every branch of the industry.

It Contains

instructive and educational articles. Hints on salesmanship and advertising. Editorials that are timely and authoritative. Facts about the new things in the trade. Trade happenings in all parts of the United States.

“Review the Music Trade With Us”

Send your \$2 now for a full year's subscription to

THE MUSIC TRADE REVIEW
373 FOURTH AVENUE NEW YORK

TALKING MACHINE WORLD SERVICE

A department devoted to promoting retail sales — conducted by Robert Gordon

EDITOR'S NOTE:—Mr. Gordon's article this month treats of what might be called the fine art of beginning your sale. This topic is of the utmost importance, and is much neglected at the present time. Doubtless you have heard the story of the Irish talking machine customer to whom the salesman played "Dot's Yiddisha Love" when he asked for songs of the old country. Things just as bad are done every day. The difference between the man who asks his customer intelligent questions, and the man who talks about the weather is the difference between a good salesman and a bad one. Mr. Gordon's analysis of the problem will go a long way toward promoting better selling.

WHEN you were a kid you probably played the kind of game where the leader thinks of a thing, and the others try to guess it by asking questions that will limit the possibilities, such as—

"Is it animal, mineral or vegetable?"

"Is it on this continent?"

"Is it in this room?"

Finally the winner guesses the thing that the leader has in mind.

The science of starting sales is akin to this game. You want to know what is in your customer's mind. Therefore, ask questions. Classify your customers. Get the right start and you'll finish right, too.

Naturally, you can't go at it as bluntly as in the kid's game; but you can get the same results.

First of all, ask yourself questions and answer them with your eyes. Size up your customer's appearance in detail, as if you were Sherlock Holmes expounding the science of deduction to Dr. Watson.

If your customer is a man, look at his complexion, hands and feet. His complexion will tell you whether he is an out-door man who works with his hands, or an office man who works with his head. The hands will tell you many other things—whether your man is of the cultured, artistic type, the laboring type, or the substantial middle-class type. Shoes and feet are extremely expressive of character, finances and station in life. Jewelry, such as scarf pin, watch chain or charm, fraternal emblems and rings add something to your estimate. The style and quality of his clothes tell you what type of talking machine he will buy.

If you are dealing with a woman, the externals are even more expressive than the man's. Her face, her hands and fingers, her clothing and jewelry, give you a good hint as to her tastes, her buying power and station in life; whether she is of the serious or frivolous type, whether the mother of a family or not, and a dozen other facts.

A man is interested more in tone quality and mechanical excellence. If he is of mechanical trend, let him wind the motor himself, talk to him about the spring and other mechanical features, and you get his attention.

A woman is interested more in the style of the talking machine, how it will look in her home, how it will match the other furniture, and its prestige value in the eyes of her friends.

All the while that your eyes are working, *ask questions*, just like the kids do in their game. Externals may sometimes mislead. Skillful questions never do, because they reveal what is in your customer's mind. Let the customers do the leading unless they are taking the wrong tack, but don't be afraid to ask direct questions yourself, such as—

"Have you ever heard our instrument before?"

The answer will be, "Yes, I have heard it at a friend's house," or "No, I am familiar with the such-and-such make," or a similar reply that will give you a direct lead.

Another question is, "Do you play any musical instrument?" The man may say "Yes, the player-piano," and then you know he can afford a fairly expensive model. He may say "No, but my wife plays the piano," or "My daughter plays the violin." Then later on you can say, "Your daughter will like this record," or "Your wife will like this model, for such-and-such reason."

The woman customer may answer that she has studied singing, which of course tells you to demonstrate some vocal records. There

may be a hundred different answers to this question, and a hundred ways for you to take advantage of them. But the principle is to get close to your customer. Make your sales argument as pointed and individual as you can.

Ask younger people, "Are you fond of dancing?" If the answer is "Yes" you can demonstrate a dance record and you can talk about volume of tone. If the answer is "No" you will have avoided the error of playing the dance record to a person who prefers other kinds of music.

Mention the name of some famous grand opera star, and ask if your customer ever heard him sing. The answer will give you all kinds of leads. The customer may say "Yes, I heard him once in 'Aida'" or "No, I prefer concerts to opera. I heard Heifetz last year when he played here."

These answers naturally tell you what sort of records to play, also the type of person to whom you are selling, and how much he or she can afford to spend.

If the answer is "No, I don't care for that kind of stuff," you will be spared the bad mistake of playing "Un Furtiva Lagrima" to a customer who hates such music and wants to hear "Ja-Da" or "Dear Old Pal of Mine."

All this seems obvious when set down in black and white. Like any other trick, it's very simple when you know how.

The only trouble is, so few people know how.

* * * * *

ABOUT a year ago a very successful plan to increase business during the summer months was put into effect by the Lauter Co., which company operates retail stores in Newark, Jersey City, Trenton and Union Hill, all of New Jersey.

The plan was tried out with one man. A list was formulated of the good customers, many of them having large accounts. The salesman took a small case full of records, and went his way. He set out to cover each one of these customers by a personal call, with a black portfolio or brief case filled with records. So as to protect the records a piece of corrugated cardboard was placed between each two records. The record collection contained about fifteen selections with perhaps duplicates of five of these. The selections were made up of the very latest pieces, of which the company had a good stock, and included operatic, standard and popular numbers.

The idea of the original plan was simply to drop in on the customers during the hot summer afternoons and evenings while the family was enjoying talking machine music and to play for them a number of the selections which it had probably been too hot for them to go to the store and hear, and to take orders for delivery next day for such records as the customers might designate.

Experience showed it advisable to make these calls in accordance with the previous appointments rather than as an impromptu affair. The final practice was to telephone a given number of homes about 9 o'clock in the morning for the purpose of making an appointment for the afternoon or evening of the same day. In the case of lady buyers the appointment was usually made for four in the afternoon and in cases where the male head of the house did the buying for between eight and eight-thirty at night. Of course where it was possible to do so a series of calls were made in the same afternoon and the same evening. The results obtained from summer canvassing of this sort were exceedingly good. The sales in single homes ran from \$8 to \$9. Occasionally orders were also placed with neighbors of the family being solicited, who were visiting at the time of the demonstration.

In fact the scheme was such a success that where a salesman sold \$5 worth of records in the store, he sold \$40 to \$50 a day outside. The intimate, comfortable atmosphere of the person's own home seemed far more conducive to sales than the store environment, at least during the hot weather.

Has your store tried this plan?

Crystal Edge MICA Diaphragms

THE STANDARD OF QUALITY AND SERVICE

PHONOGRAPH APPLIANCE CO.

109-113 West Broadway, New York

REPAIRS

TALKING MACHINE TROUBLES AND HOW TO REMEDY THEM

Conducted by Andrew H. Dodin

[This department of The Talking Machine World is designed for the service of all classes of our readers, including those who make, and those who sell, talking machines. Andrew H. Dodin, who conducts this department, has a wide and enviable reputation as a repairer of talking machines and conducts an exclusive talking machine repair shop at 176 Sixth avenue, New York. Tell him your troubles through The World and he will help you if possible. The service is free.—Editor.]

REGARDING MOTOR SPRINGS

The Talking Machine World, New York.

Will you oblige a subscriber by mailing us an answer to the following technical questions?

What widths and lengths of band steel are used in the respective models, old and new, of (1) Edison phonographs, (2) Victor Victrolas, (3) Columbias, (4) Sonoras, (5) Brunswicks, (6) Heineman motors (7) Meisselbach motors, (8) Thomas "Dayton" motors?

Where can one procure a measuring gauge to tell the thickness of band steel used in springs?

Norman.

Answer—The widths of main springs for the old style Edison phonographs are one inch by eleven feet for the standard type, one and a quarter inch by eleven feet for the home style. The Triumph model used a spring two inches wide by eleven feet long. There are several sizes and lengths of springs used in the Diamond Disc machines, the average size of which is one inch by twenty-three feet.

In the Victor models the most used springs are one inch by sixteen feet and one and one-quarter inch by eighteen and a half feet. For Columbia sizes are three-quarters of an inch by ten feet and one inch by eleven feet. In the Sonora types, three-quarters inch by ten feet and one inch by eleven feet are the sizes most used. The Brunswick, in their earlier types, used a spring one inch by eleven feet and in the later types one inch by fifteen feet.

The Heineman motor spring sizes are: Three-quarters of an inch by ten feet and three-sixteenths inch by fifteen feet and one inch by eleven feet. Meisselbach motors, seven-eighths of an inch by ten feet, one inch by ten feet and two inches by eleven feet. The Thomas "Dayton" motor spring sizes are the same in each corresponding types of motor as those used by the Meisselbach motor. The best-known Swiss motor is the Mermod motor.

A measuring gauge to tell the thickness of band steel used for springs can be obtained from any large hardware store and is called a micrometer. One of the best manufacturers of these instruments is the Brown & Sharpe Mfg. Co., 20 Vesey street, New York.

INCORPORATED

The Fred Myers Phonograph Needle Sharpener Co. of Manhattan was incorporated this week with a capital stock of \$200,000. The incorporators are L. Strauss, H. Roth and J. A. Gilman, of 225 Fifth avenue, New York.

DIE CASTINGS

In Tin, Zinc, Lead and Aluminum Alloys

LATROBE DIE & CASTING CO.

LATROBE, PENNA.

NEW YORK OFFICE: 50 CHURCH STREET
Phone Cort. 3869

PROGRESS ON NEW ARTO FACTORY

New Record Plant in Orange, N. J., Rapidly Approaching Completion

G. Howlett Davis, president of the Standard Music Roll Co., Orange, N. J., who recently formed the Arto Co. for the purpose of manu-

the extreme right is already completed and machinery for pressing records as well as for making music roll flanges is now being installed. The building plans as laid out call for the most scientific arrangement possible involving the ground space used. The center building will be ten stories high and a two-story U-shaped building will surround it. Each movement in the

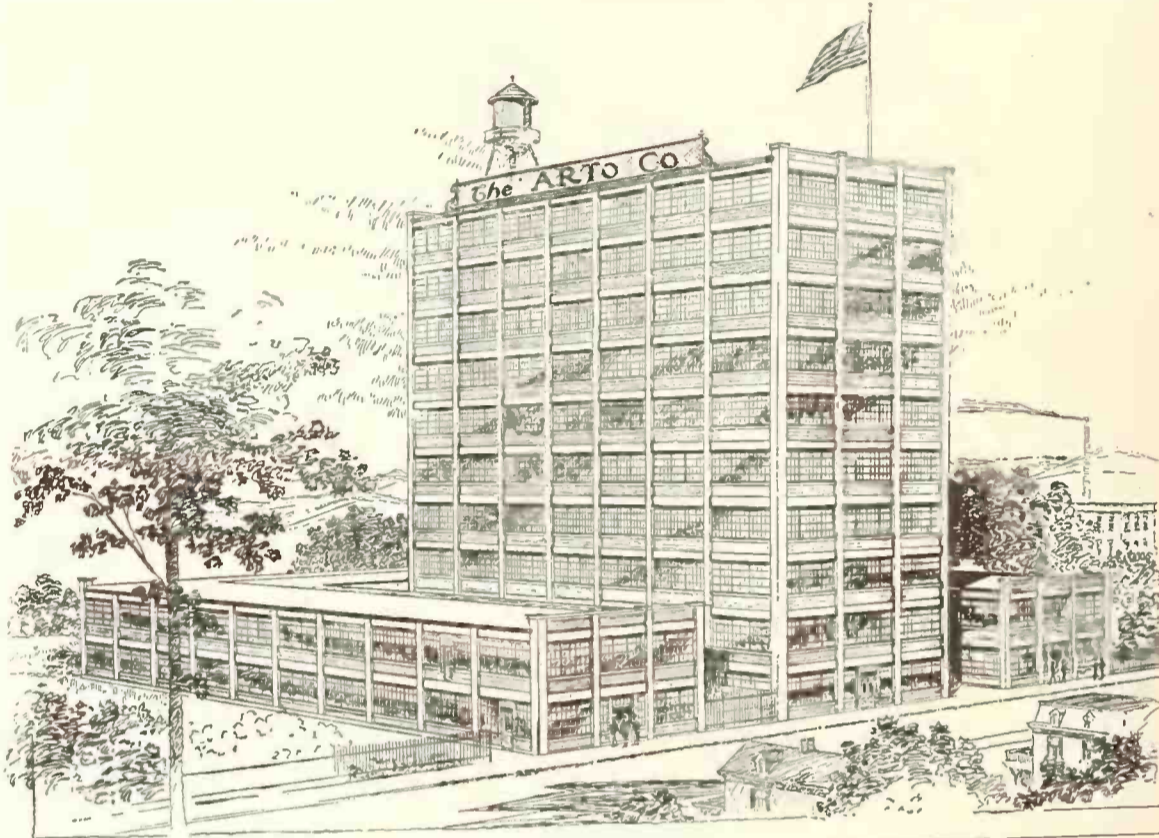

New Plant of The Arto Co., Orange, N. J.

facturing a universal-cut talking machine record, is fast seeing the home of his new organization brought to completion.

Herewith is reproduced a photograph of the new Arto Co.'s plant, situated on an acre of ground adjacent to the home of the Standard Music Roll Co. The two-story building on

process of manufacturing records or music roll flanges is made with a minimum of labor and with a great saving of time. All the heavy machinery of the plant will be housed on the first two floors and the upper stories of the larger building will house departments performing the lighter operations.

FEW BUSINESS FAILURES IN 1919

Past Six Months' Record Makes Best Showing in Nearly 40 Years—General Conditions Good—All Branches of Industry Growing

With business mortality at new low levels in recent months, says Dun's Review, a gratifying insolvency statement for the first half of 1919 has been indicated, and the exhibit is the best for the period in number of failures in nearly forty years. Exclusive of banking and other non-commercial failures there were only 3,463 defaults covering the United States in the six months ended June 30, 1919, with liabilities amounting to \$68,710,886. Excepting 1880 and 1881, the number was less than in any similar period on record. The reduction from the maximum of 12,740 failures in 1915, with \$188,587,535 liabilities, amounted to 72.8 per cent. and 63.6

per cent. respectively. The number was 41.2 per cent. and the amount of liabilities 21.7 per cent. less than in the first half of 1918.

Bradstreet's record shows 2,852 failures in the period with liabilities of \$66,371,694. The percentage of assets to liabilities was 47.8. When it is recalled, says this agency, that the number of persons, firms and corporations in business is now more than double that of 1880, some idea may be had of the shrinkage in business mortality and of the apparently very prosperous character of the business now being done. Failures reported to Bradstreet's in June numbered 412, a decrease of 44 per cent. from the number in June a year ago, of 60 per cent. from that of June, 1917, and of 72 per cent. from that of June, 1915.

As far as the talking machine and music trade industry is concerned there have been few, if any, failures.



THE REGINAPHONE

A phonograph of the highest grade with many exclusive features. The new Regina Sound-box is the greatest improvement in talking machines in years, reproducing all hill and dale and lateral cut records equally well, and in a manner unsurpassed.

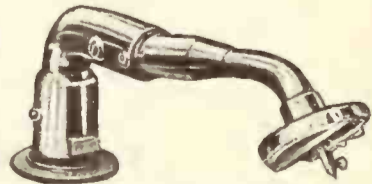

New Regins Sound-Box

Territory arrangements with active dealers. Send for particulars.

THE REGINA CO.

47 West 34th Street, NEW YORK
209 South State St., CHICAGO, ILL.

Manufacturers of the Regina Music Box and other musical instruments for over 25 years.

The BLACKMAN POLICY

During the War and TRANSITION PERIOD

DURING the War every patriotic business man willingly made the necessary sacrifices to achieve VICTORY.

DEALERS and JOBBERS generally were not able to manufacture war material but could and did give time, money and brains to the cause.

LOYALTY in the VICTOR BUSINESS was interpreted by BLACKMAN as an enlistment to "first win the war"—to support the VICTOR Company's patriotic leadership and not encourage competing manufacturers in making inroads on VICTOR supremacy while the factory was serving UNCLE SAM.

THE VICTOR Policy and the BLACKMAN Policy was a worthy sacrifice and we are glad so many BLACKMAN Dealers approved it with corresponding LOYALTY.

In allotting the small supply of VICTOR goods we received we were steadfast in our belief that we were obligated to reward loyalty and steady patronage.

In doing this we were obliged to decline new accounts and during the Transition Period we will continue that policy until the supply justifies a different one.

We are sure any fair minded Dealer will admit our obligation and we know Blackman Dealers have and will.

With greatly increased manufacture, supply and demand, however, VICTOR Distributors and Dealers must be "worthy representatives," or perhaps make way for others.

VICTOR LEADERSHIP and SUPREMACY must be maintained.

It is the BLACKMAN POLICY to help do it.

Blackman
TALKING MACHINE Co.

81 Reade Street, Near Church Street,

New York

Sales Punches for HARPONOLAS

Real Aids to the
Dealer in the Sale
of This Quality
Instrument



Our Co-operation Means Quick Profits

NO other manufacturer gives the dealer such an advertising plan, or such direct, personal sales co-operation.

AS a musical instrument *Harponola* sells quickly on its merits, as well as for its sheer beauty.

BUT—Our plan fairly makes sales double themselves.

Harponolas sell almost as fast as you uncrate them

Will You Write Today!

HARPONOLA COMPANY

EDMUND BRANDTS, Sales Manager
CELINA, OHIO

OkeH Records furnish the dealer a sure supply of high-grade selections that will sell on the right profit basis. Ask for the OkeH Record proposition.

PORTABLE GRAFONOLA FOR R-34

Portable Columbia Machine and Goodly Supply of Latest Records Being Carried by British Dirigible on Its Homeward Trip to Furnish Amusement for Members of the Crew

A Columbia Grafonola and a supply of Columbia records are being carried back to England on the British dirigible R-34, according to

was broken during the trip to America. Arrangements were therefore made immediately upon the arrival of the dirigible for a new machine, and a portable model Grafonola and a large supply of records were rushed to the landing field at Mineola, L. I., by automobile, and delivered to the members of the crew, who stowed it aboard the dirigible after inspecting it and trying some of the latest Columbia records. The picture herewith shows four members of the



Members of Crew of R-34 Inspecting Their Columbia Grafonola

an announcement made this week by the Columbia Graphophone Co. The big "blimp," which arrived in this country last Sunday morning, carried a small collapsible gramophone of British make, which formed practically the sole source of amusement for the crew, but which

crew listening to a record, the R-34 appearing in the background. Incidentally, it may be interesting to lovers of jazz to know that this class of music was plentifully represented among the records picked out by the crew to furnish them amusement while flying back to England.

SHARTLE WITH BUESCHER & SONS

Head of Credit Department of Victor Co. to Become Associated With Cleveland Wholesalers in an Executive Capacity

CLEVELAND, O., July 5.—Howard J. Shartle, for a number of years connected with the Victor Talking Machine Co. in an important capacity and for the past three years in charge of the credit department, has arranged to leave the Victor Co.'s service to become connected with the W. H. Buescher & Sons Co., prominent Victor wholesalers of this city. Mr. Shartle will acquire an interest in the company, and although his official status is not announced just now it is assumed that he will occupy the post of general manager. Mr. Shartle is capable

and aggressive and stands high in the esteem of Victor distributors and his associates with the company. When he takes up his new work he will take the best wishes of his friends with him. It is reported that he will come to Cleveland about September 1.

NEW EMERSON GOLD SEAL CATALOG

The Emerson Phonograph Co. announces that on July 1 it will release a catalog giving a complete list of all the gold seal records which have been issued by the company. This catalog will be made up in a handsome way with attractive colored covers and containing many illustrations throughout. For the convenience of the user the catalog contains in the back a numerical and alphabetical index.

We Aim to Please—Give us a Trial

HAVE YOUR REPAIRS MADE WHERE THEY ARE MADE RIGHT

We are equipped to make prompt repairing of all makes of American and foreign Talking Machines—new models or old-timers.

**FULL LINE OF REPAIR PARTS ON HAND
WE MAKE WHAT WE HAVEN'T IN STOCK**

Special attention given to repairs received by mail or express

PHONOGRAPHS MADE TO ORDER

**MANHATTAN PHONOGRAPH CO., 75 EAST 4th STREET
NEW YORK**

Anything You Want to Sell—We Will Buy It

Anything You Need, and Can't Get—Just Try Us

Anything That Needs Fixing—Send It to Us

MAKING OF SPRINGS FOR MOTORS

Being Specialized in by the Schwartz-Herrman Steel Works, Inc., of Somerville, N. J.—Institution Widely Known in This Field

SOMERVILLE, N. J., July 8.—The Schwartz-Herrman Steel Works, Inc., are specializing strongly in the production of springs for talking machine

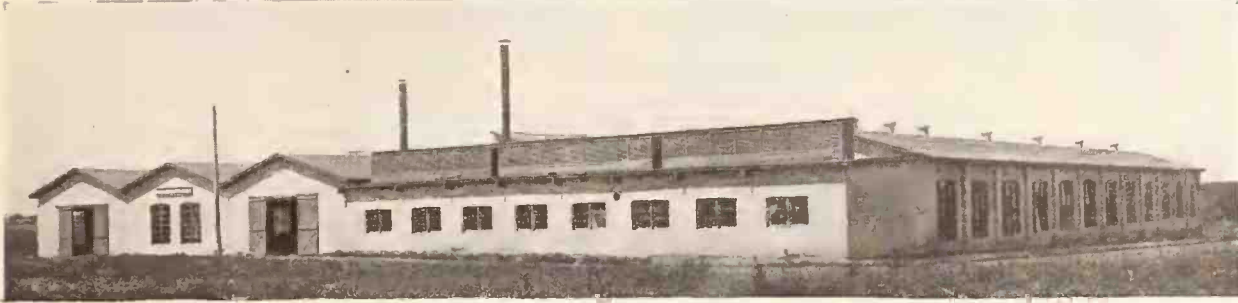

Plant of the Schwartz-Herrman Steel Works, Inc., Somerville, N. J.

motors. They are widely known as manufacturers of high grade specialties in tempered and untempered strip steel. Although they have made springs for the trade for many years, the remarkable activity manifested in the talking machine industry at the present day has led them to specialize even more strongly in this product. Their organization of trained metallurgists and engineers have developed an intimate knowledge of steel, which they have applied to the talking machine spring industry and have developed what they feel to be a logical spring that will meet the most rigid requirements. As most aptly expressing the qualities contained in this spring they have given it the name of "Lion Heart." A fast rule of the organization from its earliest history is to produce but one quality.

Louis Schwartz, president and general manager of the company, reports that they are very busy. Their large plant in this city is well equipped and new machinery is being installed in accordance with the demand. Mr. Schwartz is also very optimistic over the bright prospects for the future in the talking machine industry and is accordingly laying his plans to efficiently care for the constantly increasing business.

EMERSON FOREIGN EXPANSION

Have Thirty Branches in Fifteen Countries Outside of the United States—New Distribution in Cuba—Latin-American Catalog Soon

The export department of the Emerson International, Inc., which has been unusually active during the past month, reports that a number of valuable distributing franchises under the control of the foreign branches have been made. At the present time there are over thirty branches in fifteen countries outside of the United States.

Arrangements have just recently been completed with the well-known firm of Quevedo & Carbarga, of Havana, Cuba, for the exclusive distribution of Emerson records. Mr. Quevedo, who was present at the recording of several Cuban numbers for Emerson records, expressed his confidence that the sales of such records in Cuba would be unusually large. A new executive and sales force has been attached to this company in order to handle the proper distribution of Emerson records throughout the Island of Cuba.

In order that they may keep abreast with the export tendencies a Spanish catalog of typical Spanish, Cuban and Mexican selections has just been released for the South American trade. A new catalog of Russian selections and a list of Bohemian and Czecho-Slovak records has also been released, these records marking the latest addition to the Emerson list.

That the Emerson International has not overlooked the demand for foreign music in America may be shown through the fact that the Carpenter Paper Co., of Omaha, Neb., and the Southern Sonora Phono Co., of Alabama, have been added to their list of distributors.

EDISON PHONOGRAPH FOR R-34 CREW

Wife Presents Gift, With Letter From Inventor Praising Ocean Flight

ORANGE, N. J., July 9.—When Mrs. Thomas A. Edison presented an army and navy model phonograph and fifty records to the British dirigible R-34 at Roosevelt Field, the gift of her

ing letter from Mr. Edison. It read as follows:

"I have been greatly interested in your exploit, as it is the opening of a new epoch in human progress. Were it not for some important experiments I have on hand I would have given myself the pleasure of a call on you to extend in person my hearty congratulations on your great achievement. Will you give me the pleasure of accepting one of my phonographs with some records and carry the same on your return trip in commemoration of the first air voyage to America?"

"Wishing you a pleasant and safe return and with my compliments to you and your associates, I remain,
"THOMAS A. EDISON."

HANDLES THE MOTROLA

W. D. & C. N. Andrews, of Buffalo, and the W. D. Andrews Co., of Syracuse, N. Y., have added the Jones Motrola to the lines they wholesale. The arrangement was consummated during the past month.

Have Won Success on Merit

When this record was placed on the market it immediately attracted the attention of wide-awake dealers, for actual tests proved that it is by far the best hill and dale record ever produced.

Prompt Deliveries of Popular Hits

We are in a position to offer dealers efficient and practical cooperation in handling OkeH records. Our stocks are complete. Our sales organization is experienced, and can help you SELL OkeH records.



OkeH Dealers Get Liberal Discounts

WRITE FOR FULL DETAILS

GREAT EASTERN MANUFACTURERS CO.

316 SOUTH WABASH AVENUE

CHICAGO, ILL.

OkeH Jobbers

From **\$85** **CULPTONE** To **\$225**

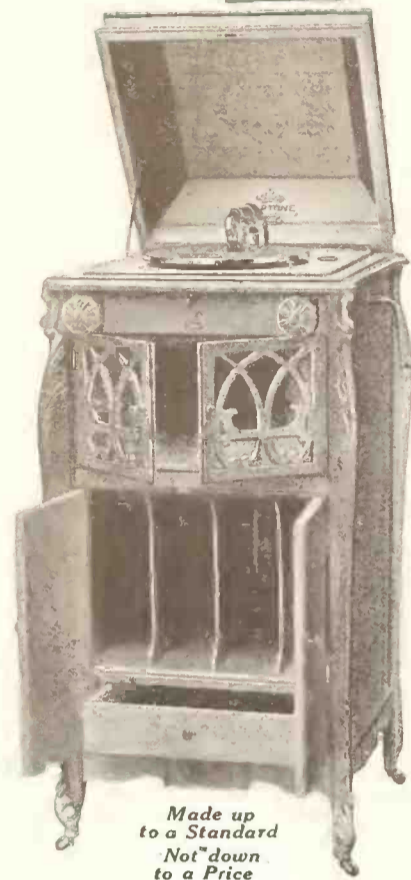

Made up to a Standard Not down to a Price

CULP PHONOGRAPH CO.
298 Broadway New York
NOTE NEW ADDRESS

A line of wide range of styles and prices.

Cabinets are handsome in appearance and equipped with the most modern accessories.

Dealers investigate!

SUMMER SALES STIMULANT

An original and clever plan for giving publicity to Columbia records and Grafonolas has



Front View of Fan

recently been disclosed by the Columbia Graphophone Co. It is a fan made of sub-

Fireproofing Co. When this building is completed it will add 40 per cent. more floor space to the Pathé plant.

The new structure is the first of three units which they propose to erect within a very short time on Grand avenue, between Flushing and Park avenues. These buildings will be used entirely for the manufacture of records. Every known modern appliance is to be installed and will be the means of adding 1,000 more employes to the 700 now engaged in the plant.

Since Pathé first occupied the building on Grand avenue a year ago their business has grown 500 per cent. By a recent purchase they acquired the C. B. French Cabinet Plant at Metropolitan and Flushing avenues, with 110,000 feet of floor space. This branch is now running at full capacity in making one type of cabinet. In addition to this the Pathé Frères Co. controls many other cabinet factories.

The Freeport Music Co., Pathé dealers, have leased a second store in Freeport, Ill.

stantial cardboard with a wooden handle. As the illustration shows, one side brings publicity to the Grafonola, while the reverse side brings publicity to the Columbia records. The dis-

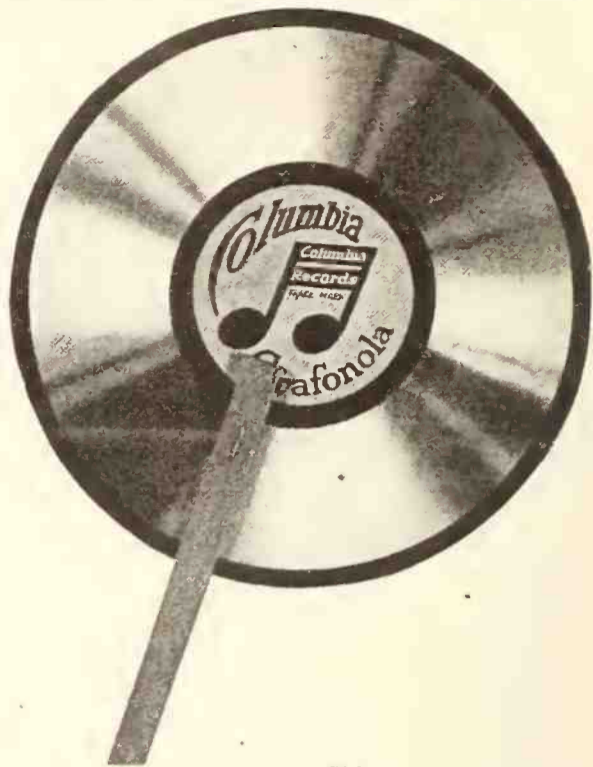

Reverse Side

tribution of such publicity should be a popular move during the hot weather.

START WORK ON NEW PATHE PLANT

Addition to Factory Resources Will Increase Output Materially—Business Very Active

Public announcement was made recently of an important Pathé move referred to in The World some time ago. This is the erection of a seven-story reinforced concrete building 170 feet front and 90 feet deep adjoining the present building of the Pathé Frères Phonograph Co., at 20 Grand avenue, Brooklyn, N. Y. The construction contract has been secured by the White

Why Break Records? Just File Them!

That is if you have the wonderful Record filing system which is a feature of

The Marvelous MAGNOLA



Watching the Music Come Out

This is only one feature of many that will command your interest and attention. Let us send you handsome illustrated catalog and information as to our plans for helping you to make money with MAGNOLA.

MAGNOLA TALKING MACHINE COMPANY

OTTO SCHULZ, President
General Offices Southern Wholesale Branch
711 MILWAUKEE AVENUE 1530 CANDLER BLDG.
CHICAGO ATLANTA, GA.

A NEW YORK INCORPORATION

The Acme Phonograph Corp. was incorporated this week under the laws of New York, with a capital of \$100,000, by Fred H. Hedinger, Chas. P. Evans and Viola Walsh.

SUPERINTENDENT WANTED

Superintendent wanted immediately by exclusive phonograph factory near Chicago, to take complete charge. Liberal salary. References. Address "J. Y.," care The Talking Machine World, 209 South State St., Chicago, Ill.

A Wonderful Success!

The **"Best"** semi-permanent Stylus

NO SCRATCH

NO HISS

Plays 100 to 300 Records

Cranks on Tone, who have used every needle, are now perfectly satisfied with The Best Stylus.

Write now for free samples, attractive discounts and descriptive circulars which we furnish for your mailing list.

The Ansonia Needle Co.

Ansonia



Conn.

"SMALL GOODS" A BIG ASSET TO DEALERS IN "TALKERS"

Samuel Buegeleisen, of Buegeleisen & Jacobson, Points Out How Talking Machine Dealers Can Create Prospects for Talking Machines by First Attracting Them Through Smaller Articles

Samuel Buegeleisen, of Buegeleisen & Jacobson, in an interview with The World emphasized strongly the advantages to be gained by the talking machine dealer also carrying a line of musical merchandise.

"The harmonica buyer of to-day is the talking machine buyer of to-morrow. With little or no extra expense the dealer can put in a very good line of small goods which if properly displayed will not only add luster to his establishment, but will make his place the headquarters of everything musical. To become known as 'the' musical dealer of the town is the reputation sought for.

"There are over a hundred million people in the U. S. and every one of them is a likely purchaser of something in the musical line. Each dealer has his own town to work on, and he certainly can get all of its business if he will go after it. Why do the mail order houses pull so much business from small towns? Because the people's wants cannot be supplied by the local dealers, whereas the mail order houses carry complete lines, and advertise in such an attractive manner that they draw the buying public to them. Why should the town dealer let all that business get away, when it is perfectly possible for him to obtain a part if not all of it?

"Talking machine dealers expend large sums to get the prospect into the store. Much of this expense will not be necessary if they also carry small goods, and have a proper window display. They will then be catering to the masses and the man who wants something in the musical line will not send miles away for it if he can get it in his home store.

"The subject of display is a vital one. To the average person nothing looks so bleak and cold in a store window as a lone piano or a talking machine. How many people stop to look at

such a window, even though it may have a setting of fine draperies and a handsome lamp or something of that sort entirely foreign to the nature of the merchandise displayed? You can fill windows with only talking machines and they will not get half as many 'lookers' as one window properly dressed with violins, banjos, drums, band instruments, etc. Why not these instead of the lamp and the draperies or other trimmings which take up valuable space and can bring you nothing? There is no line of merchandise in the world, and I say this without prejudice, that is capable of such attractive window display as musical instruments—well arranged with prices shown on the various articles. Such a window will be so full of human interest that it will take the 'looker' by the coat and lead him right into your store.

"By way of comparison learn the lesson that the modern cigar store has to teach. In former years the usual tobacco store was a dingy place, a window full of junk and a wooden Indian in front. The only way you could tell it was a tobacco store was because the Indian stuck so manfully to his job. What was the result? Attracted by clever magazine advertising on the part of manufacturers of cigars, the discriminating cigar smoker sent away for his smokes. A certain tobacco company solved the problem by studying the wants of the public and by up-to-date methods of display that made their windows almost speak to the passer-by. Other cigar stores followed suit and as a result the mail order advertising of cigars, etc., has practically ceased. The consumer can now get what he wants in his home store.

"The talking machine dealer can bring about the same results if he will take the tip. We have representatives in every part of the country who are trained to assist the dealer in selecting his line, and if any that are interested will com-

ILSLEY'S GRAPHITE PHONO SPRING LUBRICANT

*Ilsley's Lubricant makes the Motor make good
Is prepared in the proper consistency, will not run out, dry up, or become sticky or rancid. Remains in its original form indefinitely.
Put up in 1, 5, 10, 25 and 50-pound cans for dealers.*

This lubricant is also put up in 4-ounce cans to retail at 25 cents each under the trade name of

EUREKA NOISELESS TALKING MACHINE LUBRICANT

Write for special proposition to jobbers.

ILSLEY-DOUBLEDAY & CO., 229-231 Front St., New York

municate with us we will have our salesman drop in to see him the next time he is in his locality."

A VISITOR FROM CALIFORNIA

F. A. Levy, of San Francisco, Particularly Interested in Trade Association Affairs

F. A. Levy, president of the California Phonograph Co., San Francisco, Cal., has been visiting the factories of all the larger talking machine companies during the past two weeks. Mr. Levy is president of the Talking Machine Dealers' Association of San Francisco and while in New York was very much interested in the local dealers' association, the Talking Machine Men, Inc. While a visitor at the World offices Mr. Levy stated that his association had been able to accomplish much for better business since it was organized and with their present organization and plans they will be enabled to make greater progress in the future.

INTRODUCE THE PETMECKY

The Brilliantone Steel Needle Co., New York City, in addition to their regular line of needles have now placed on the market the Petmecky Multi-Tone self-sharpening needle. The one needle, according to its position, will give loud, soft or medium tones and will play ten records. Although only recently presented to the trade this needle is already in high favor throughout and many re-orders are reported.

THE G. T. WILLIAMS CO., INC.

EXCLUSIVELY

VICTOR

WHOLESALE

217-221 DUFFIELD ST.,

BROOKLYN, N. Y.

WORLD'S CLASSIFIED ADVERTISING

Any member of the trade may forward to this office a "Situation" advertisement intended for this Department to occupy a space of four lines, agate measure, and it will be inserted free. Replies will also be forwarded without cost. Additional space will be at the rate of 25c. per line. If bold faced type is desired the cost of same will be 25c. per line.

AM I THE MAN YOU ARE LOOKING FOR? Eighteen years actively engaged in the talking machine business. Wholesale and retail experience. Manager of three large retail stores. Conversant with the Victor, Columbia and Edison lines. Twelve years with the present concern. An aggressive, hustling live-wire who can show results. Well known among the trade. Address "Box 662," care The Talking Machine World, 373 Fourth Ave., New York, N. Y.

SALESMAN—Must be of high mental caliber, able to give highest references and have thorough acquaintance with the phonograph trade in his territory for side line or exclusive. Greatest and fastest selling accessory on the market. New. Commission. Send all details with first letter. Confidential. Address "Box 663," care The Talking Machine World, 373 Fourth Ave., New York.

WANTED—Sales Manager, capable of handling sales department of a successful going phonograph company. Address "Box 664," The Talking Machine World, 373 Fourth Ave., New York City.

WANTED—First class all-around repairman, one who can assemble motor and tone arms in cabinets. Good wages to the right party, others please do not write. Player-Tone Talking Machine Co., 954 Penn Ave., Pittsburgh, Pa.

SITUATION WANTED—Would like position with reliable concern building, or desiring to build, a high-grade phonograph. Am thirty-six years old, temperate and had about fourteen years in the construction of the phonograph. Also have several good inventions which I would gladly turn over to the right parties. Address "Box 624," care The Talking Machine World, 373 Fourth Ave., New York.

SALESMEN WANTED—Road men with A-1 references, widely acquainted among Western piano, music and furniture houses. Have high grade, well advertised phonograph proposition on side line basis. Give age, detailed experience and reference in first letter. Address "Box 648," care The Talking Machine World, 373 Fourth Ave., New York.

SITUATION WANTED—Young man 33 years of age just returned from service wishes position as foreman. Seven years' experience in motor and assembling department, also have had charge of same. Best of reference as to character and mechanical ability. Address "Box 665," care The Talking Machine World, 373 Fourth Ave., New York.

WANTED—Position as foreman or repair man. Twelve years' experience. Take complete charge. Address "J. U. 30," care Talking Machine World, 209 South State St., Chicago, Ill.

WANTED GRAFONOLA BUYER—By one of the largest department stores south of New York. Applicant must have known ability and initiative. The department is in its infancy and offers excellent opportunity to develop. Letter of application must contain full information as to past record, present connection and salary expectations. All replies are confidential. Address "Box 666," care The Talking Machine World, 373 Fourth Ave., New York.

POSITION WANTED—If you desire competent high-class manager and salesman for phonograph, piano store or department, answer giving full particulars. Am employed at good salary and commission but want to get out of South or change climate. Eight years' experience, twelve years' phonograph experience (Victrola, Edison, Columbia or Vocalion), nine of these years manager and four wholesale experience. Can give former and present employers as references. Would consider buying stock in business later. Box E. D. R., care The Talking Machine World, 373 Fourth Ave., New York.

WANTED—A young lady or a young man to take care of our Victor Department. Also assistants. Address "Box 667," care The Talking Machine World, 373 Fourth Ave., New York.

EXPERIENCED talking machine salesman with large following, covering Chicago and surrounding territory, is open for a good line. Address J. N. 20, The Talking Machine World, 209 South State St., Chicago, Ill.

WANTED POSITION—Sales manager, assistant manager, or production supervisor for Western phonograph company, Chicago preferred. Eight years' experience. Best references. Address J. U. 16, care The Talking Machine World, 209 South State St., Chicago, Ill.

SITUATION WANTED—An all around talking machine man with a practical knowledge to take charge of manufacturing plant desires position with a reliable firm in the Middle West. Best references. Address "Box 669," care The Talking Machine World, 373 Fourth Ave., New York.

POSITION WANTED—Talking machine man, many years in trade, wide acquaintance, desires to represent line of talking machines or accessories in the East. Address "Box 668," care The Talking Machine World, 373 Fourth Ave., New York.

SITUATION WANTED—Man (thirty-eight), married, five years' experience with Columbia, Victor and Brunswick, desires a position as manager of talking machine department. Can furnish best of reference. Address "Box 651," care The Talking Machine World, 373 Fourth Ave., New York.

POSITION WANTED by ex-Victrola traveler, capable of taking charge of and increasing sales of your talking machine department. Married, man of character and energy; only a salary and commission, or straight commission basis considered. Address "Box 652," care The Talking Machine World, 373 Fourth Ave., New York, N. Y.

SALESMAN WANTED—Phonograph salesman wanted to take on a complete line of phonograph accessories. Every dealer a customer. Address "J. N. 4," care The Talking Machine World, 209 South State St., Chicago, Ill.

POSITION DESIRED by first-class varnisher, rubber and polisher, as foreman with concern making cabinets. Can furnish first-class reference, both from piano and cabinet shops. Understand assembling of all kinds of motors. Address "Box 653," care The Talking Machine World, 373 Fourth Ave., New York.

WANTED—Two young men, hustlers, as Edison phonograph salesmen, who can show results and are active in selling the goods for us. State experience and salary you expect. Best of chances for improvements to the right party. Married men preferred. Mostly outside work, will, if necessary, furnish Ford to travel with. Address "Box K," care The Talking Machine World, 373 Fourth Ave., New York.

SALESMAN—Experienced live-wire man. One who can take charge of phonograph department, desires connection with retail concern either in an executive or sales capacity. Best references. Address "Box 656," care The Talking Machine World, 373 Fourth Ave., New York.

SITUATION WANTED by Victrola salesman for New York City vicinity. References. Address "Box 657," care The Talking Machine World, 373 Fourth Ave., New York, N. Y.

WE want a man who understands plating and pressing records and the making of recording wax and mixing of record material. Write giving references and experience. Don't waste your time trying to flourish. Address "Box 658," care The Talking Machine World, 373 Fourth Ave., New York.

WANTED—A retail inside Victrola and Victor record salesman, who is acquainted with the city of Brooklyn. Man with experience and high class reference need only to apply. Address "Box 659," care The Talking Machine World, 373 Fourth Ave., New York.

WANTED—A live wire manager for an exclusive phonograph department, state experience and salary expected in first letter. A. B. Smith Piano Co., 190 South Main St., Akron, O.

WANTED—Phonograph accessories salesman to call on manufacturers. Not less than \$5,000 a year to right man. Gentle only. Address "M. A. 3," care The Talking Machine World, 209 South State St., Chicago, Ill.

WANTED—Five live wire salesmen to handle our phonographs, state experience. A. B. Smith Piano Co., 190 South Main St., Akron, O.

SITUATION WANTED—An American thoroughly conversant with the export trade wants to represent a reliable talking machine manufacturer to develop an export business. Address "Box 640," care The Talking Machine World, 373 Fourth Ave., New York.

SITUATION WANTED—Ten years' experience in talking machine line, motor repairer, wood finisher, polisher, shipping clerk, etc., desires steady position in New York. Address "Box 641," care The Talking Machine World, 373 Fourth Ave., New York.

WANTED—Position in phonograph factory as foreman in mill and cabinet room. Fifteen years' experience in Eastern factory. Address "A. P. 11," care The Talking Machine World, 209 South State St., Chicago, Ill.

WILL represent firms of East, manufacturing supplies and accessories suitable to phonograph and piano stores on the Pacific Coast. Address "N. A.," care Columbia Graphophone Co., 745 South Broadway, Los Angeles, Cal.

SITUATION WANTED—By man (33) expert mechanic in all branches of manufacturing and repairing of talking machines. Take complete charge of plant. Twelve years' experience as working foreman and manager. Understand every point of the business, am at present at liberty to connect with some reliable firm. Address "Box 642," care The Talking Machine World, 373 Fourth Ave., New York.

POSITION WANTED—Young married man, with years of experience, to take charge of phonograph department. Preferably the Brunswick. Am a live wire and can produce the business. At present located, reason for changing, to better myself. Good references. Address "Box 643," care The Talking Machine World, 373 Fourth Ave., New York.

SITUATION WANTED—Am open for a good proposition from some reliable piano or talking machine man, either as traveling salesman or the right proposition in handling on consignment (latter preferred). Results guaranteed. Address "Box 644," care The Talking Machine World, 373 Fourth Ave., New York.

POSITION WANTED BY A SALESMAN—Have a large following among talking machine dealers, furniture dealers and general department stores. Am looking for good lines on a commission basis such as talking machines, accessories, music rolls, needles, etc. Address "Box 627," care The Talking Machine World, 373 Fourth Ave., New York.

PHONOGRAPH SALESMAN WANTED—Man wanted who can sell phonographs of high-class grade. We need you now. Address "Box 626," care The Talking Machine World, 373 Fourth Ave., New York.

SALESMAN WANTED—To handle the ALL-IN-ONE attachment for Victor and Columbia machines as a side line over the Dominion of Canada on a Commission Basis. Address L. Bourgette, 16 McGill College Ave., Room 3, Montreal, Canada.

POSITION WANTED by lady as manager and buyer of Victor Record Department. Six years' experience. West preferred. Address "Box 628," care The Talking Machine World, 373 Fourth Ave., New York.

SITUATION WANTED—Man (35), married, three years' experience with the Sonora Phonograph Corp., wishes position. Capable of taking charge of accessories department. Can furnish references. Address "Box 629," care The Talking Machine World, 373 Fourth Ave., New York.

POSITION WANTED—Would like to hear from manufacturers of talking machines and records with full particulars as to agency proposition, and with view to appointment as exclusive Southern representative. Also with Atlanta as distributing point. Address "Box 630," care The Talking Machine World, 373 Fourth Ave., New York.

WANTED—Phonograph manufacturing expert to take superintendent's position in Canadian manufacturing plant and take charge of same. Apply "Box 611," care The Talking Machine World, 373 Fourth Ave., New York.

WANTED—Position in Detroit. Have been away five years managing talking machine store in town of 30,000, handling Victor, Edison and Columbia lines. Know every phase of the business and have had good success. Can furnish high-class references. Address "Box 620," care The Talking Machine World, 373 Fourth Ave., New York.

WANTED—Manager for Canadian phonograph and record plant. Must understand both lines and be capable of taking full charge. An exceptional opportunity for the right party. Paramount Phonograph & Record Co. of Canada, Ltd., 200 Papinsau Ave., Montreal, Canada.

POSITION WANTED—A Brooklyn young man (married) would like to get a position anywhere in talking machine line, where there is a chance for advancement; city or country. Can be used as all around man as I can be shipping clerk, salesman, repair man, assembler, delivery man, willing to work, not afraid of hard work or long hours. Address "Box 650," care The Talking Machine World, 373 Fourth Ave., New York.

Cash always ready for jobs, large or small, in phonographs and records, new or used; what have you that you want to turn into cash?

W. A. COLES,
Dealer in Phonographs and Records
3 Savin St. Roxbury, Mass.

FOR SALE

Phonograph records, Victor, Columbia, Emerson (Brand New). A very fine assortment of vocal and instrumental selections. Particulars given upon request.

I. DECKINGER
3064 Albany-Crescent Ave. New York, N. Y.

Sapphire jewel needles for Pathé and Edison records.

Our prices will surprise you.

COLE & DUNAS MUSIC CO.,
54 West Lake St. Chicago, Ill.

Will close out an overstock of steel needles in both soft and loud tones at 3½ cents per hundred. No order too small or too large.

COLE & DUNAS MUSIC CO.
54 West Lake St. Chicago, Ill.

WANTED—SPOT CASH PAID

Any amount of records in all languages. Talking Machines, horn or hornless. Parts of all makes, record cabinets, etc.

VICTORIA RECORD EXCHANGE
2104 Third Avenue New York
Phone Harlem 7848

BUSINESS OPPORTUNITY

WANTED—Distributors and agents for State territories by manufacturer of latest designed and most up-to-date phonograph on market. Applicants must be financially able to handle territory and push same. A good-paying proposition for live, active men. Address "M. S. 2," care The Talking Machine World, 209 South State St., Chicago, Ill.

INTERNATIONAL MOTOR

is the silent running motor, built in Canada, on the right principles, best of material and correct workmanship. It is not a cheap imitation but a high-class production, manufactured by

INTERNATIONAL MACHINE & MFG. CO., LTD.
111 Adelaide St. W. Toronto, Canada

SOMETHING NEW

A NEW TYPE TALKING MACHINE

INVENTOR WILL SELL RIGHTS

You large companies who are going to be eventually swamped by cheap machines, nearly—to be polite—as good as yours should be interested.

My instrument is not a freak, it is not radically unlike your own or others, yet it is DIFFERENT. This difference would enable you to keep up your prices on the ground of IMPROVEMENT. It has STRONG selling points based on sound logic and common sense.

Regarding tonal quality and volume, I believe my instrument to be far better than yours. See and hear it, then judge for yourself.

Appointment by letter only.

BOX 660, TALKING MACHINE WORLD
373 4th Avenue, New York City

Do you need talking machine cabinets?

If so—we would like to hear from you as we can perhaps handle a good portion of the case work for you.

Address Box MR 2, c.o.
Talking Machine World,
373 Fourth Ave., New York City.

WANTED

We are in the market for some 5,000 to 10,000 high-grade talking machine cabinets of our design for direct single shipment to customers in Middle West. We furnish motor equipment and part of hardware. Address "Box 661," care The Talking Machine World, 373 Fourth Ave., New York, N. Y.

WANTED

Opportunity for quoting on phonograph cabinets by a general woodworking company of twenty-five years' experience. Capacity of 50 to 100 cabinets per day. Address "Box 639," care The Talking Machine World, 373 Fourth Ave., New York.

FOR SALE

At a bargain for immediate delivery a lot of phonographs in handsome popular model similar in appearance and size to standard \$115 type. Write for further particulars. "Box W. M.," 1004 Mallery Building, Chicago, Ill.

INCREASED LIST OF DEALERS

The Charmaphone Co., manufacturers of the Charmaphone phonographs, continue to add to the list of dealers handling their line of popular-priced machines. The company's factory is working overtime to fill the demands, and from present indications working at capacity for many months to come will hardly enable the sales department to feel at ease with the conditions. Orders are being booked well in advance and the large factory of the concern is speeding up in every possible way, without lowering the quality, to handle the present heavy sales.

NEW GRAFONOLA DEALERS

Landsman & Carf, Inc., have opened an attractive store at 466 Sixth avenue, New York, near Twenty-eighth street, where they are featuring a complete line of Columbia Grafonolas and records as well as Q R S and other makes of music rolls, photographic supplies and other goods. The outlook for the coming season is unusually bright.

The FULTON

We are now offering to dealers our New Improved Maestola Phonograph, Mahogany, 14x14x7 1/2". Motor plays 4 10" Records with one winding. 12" Turn Table, Dial Regulator. Price \$6.00 each and Sample \$6.50.

CASH WITH ORDER

Best American Steel Phonograph Needles
TRUETONE or CLEARSTONE

200 to a metal box, or
100 to a package, 55c

Per thousand, 50c in lots of 100,000

Phonograph parts and accessories, as Motors, Tone Arms, Sound Boxes, Cabinets, and Cabinet Hardware. Repair parts for all makes.

Records—Standard make, Lateral Cut, at \$40.00 per 100.

FULTON TALKING MACHINE CO.
640 Broadway New York, N. Y.

MR. TAUBER FAVORABLY IMPRESSED

D. Tauber, president of the Progressive Phonograph Supply Co., New York City, returned from an extensive trip in time to attend the jobbers' convention at Atlantic City. His trip carried him as far as the Pacific Coast and then as far south as Texas. Mr. Tauber was much impressed with the excellent business conditions prevalent in the talking machine trade, and found that these conditions were not alone confined to any one section of the country, but covered all sections.

ELECTION OF EMERSON DIRECTORS

The annual election of the directors of the Emerson Phonograph Co. was held last month. All but two of the directors were re-elected, those two being G. Sylvester and John Van der Werss. The two newly elected directors are Louis B. Hall, Jr., of the banking firm of James B. Colgate, New York City, and Jacob Scholer, attorney, member of the firm of Kaye, Mc-Davitt & Scholer, New York City.

NEW CABINET CO. INCORPORATED

The Independent Phonograph Cabinet Co. was recently incorporated in Camden, N. J., for the purpose of making phonograph cabinets.

HANDLING SUBSTANTIAL BUSINESS

The new Pathé phonograph department of the Brock Music Co., Louisville, Ky., which was installed about a month ago, is now in full swing, and is handling a substantial business. A large stock of machines and records is on hand to take care of the demand.

DIAMOND POINTS and SAPPHIRES

In Any Quantity

LUCKY 13 PHONOGRAPH CO.
46 East 12th Street, New York

R. H. ZINKE IN THE EAST

President of the Record Needle & Mfg. Co., Milwaukee, Attends Convention and Enjoys Vacation Which He Spent at Eastern Points

R. H. Zinke, president of the Record Needle & Mfg. Co., Milwaukee, Wis., was one of those who were present at the recent convention of the National Association of Talking Machine Jobbers in Atlantic City, where he met a number of friends who were interested in his product and in his personality.

Mr. Zinke has been spending a vacation in the East, and while in New York made his headquarters at the Elks' Club, 108 West Forty-third street. He enjoyed his stay in the metropolis immensely and while he did not devote himself strenuously to business, being here on a vacation, yet he has managed to bring the merits of his products to the attention of many members of the trade.

Mr. Zinke has perfected plans for a very active campaign in behalf of the various specialties which his company manufactures, and it can be safely said that the Record Needle & Mfg. Co. will cut a considerable figure in the trade this fall.

"PATHE NEWS" MAKES ITS DEBUT

Issue number one of volume number one of Pathé News came off the press Wednesday, June 25, 1919. It is a four-page newspaper devoted to items of news about the Pathé industry, and also features the advertisements, etc., which the Pathé advertising department is preparing for the use of its dealers. The whole paper is gotten up in an exceedingly snappy style. It is full newspaper size, but is printed on a super paper, so as to reproduce half-tones. The first issue of Pathé News contains a very striking picture of the Pathé plant.

MATTHEWS BUYS MASTER WAX CO.

F. W. Matthews, well known in recording circles, both on this continent and in England, recently purchased control of the Master Wax Co., of Milburn, N. J. All master wax made by this company will in the future be made under his direct supervision. In a chat with The World Mr. Matthews stated that it is very difficult to obtain supplies for the making of wax at the present time.

WE WILL MAKE YOUR RECORDS FOR YOU



IF you wish to make vocal or instrumental records of solos, quartets, choruses, orchestras, bands, etc.; either for your own use or to sell, we are at your service.

Ask Us About It

American Recording Laboratories
56 W. 45th St. New York, N. Y.

GARFORD EMPLOYEES HOLD OUTING

Baseball Games and Other Sports Entered Into With Great Enthusiasm—Prizes of Money, Phonographs and Records Awarded

ELYRIA, OHIO, July 3.—The employes of the Garford Mfg. Co. of this city held their annual picnic at Crystal Beach, Ohio, recently and this outing was the most successful that has ever been given by the employes of this company. The picnic was arranged under the auspices of the Shop Committee and the various sub-committees worked untiringly to make the day enjoyable from start to finish. Over 1,400 Garford employes attended the picnic and from the moment that they arrived at Crystal Beach they were kept busy participating in the various events on the sport program.

Starting after luncheon, the dance devotees were given free reign and a prize waltz at 4 o'clock brought forth many of the dance experts of the factory. The second and third prizes consisted of OkeH records, which were donated by the Otto Heineman Phonograph Supply Co., Inc.

The men's ball game was called at 10:30 a. m., the winners receiving \$25 and the losers \$15; these prizes being contributed by A. G. Bean, president of the Garford Mfg. Co. The prizes for the girls' ball game consisted of \$20 for the winners and \$10 for the losers; Otto Heineman, chairman of the board of directors of the Garford Mfg. Co., donating these prizes.

There were 50-yard and 100-yard dashes for young men, single ladies, married ladies and girls under 14 years, and other unique events on the program consisted of a fat man's race, fat ladies' race, a three-legged race, pie-eating contest, cracker-eating contest, egg-eating content and a tug-of-war.

There were several cash prizes donated by Otto Heineman and other prizes consisted of Model "C" Garford phonographs, OkeH records, boxes of cigars, etc. The Garford phonographs were donated by the Garford Mfg. Co., and the OkeH records by the Otto Heineman Phonograph Supply Co., Inc. Other well-known companies also donated prizes for these sports.

The Jones Music House, Grand Rapids, Mich., is carrying on an extensive advertising campaign, to push the sale of special vacation outfits of portable machines.

This advertising is very timely and the results have shown that all people need is a little reminder.

AN ATTRACTIVE EMERSON WINDOW DISPLAY FOR JULY



The above illustration shows an attractive Emerson co-operative window display for July. This service of window designs for Emerson dealers is a big factor in promoting the sales of Emerson records throughout the country.

MANY NOTABLE INSTALLATIONS

Demand for Van Veen Booths Will Compel the Opening of a Branch in Chicago—Business Very Active Throughout the Country

Arthur L. Van Veen, of Arthur L. Van Veen & Co., reports that orders for Van Veen "Bed Set" booths, record racks and counters are coming in strongly from the South and West. Business from this section of the country has grown

in such large proportions that preparations are being made to open up a branch office in Chicago. A number of successful installations have recently been completed in the South and through Pennsylvania which have called forth enthusiastic commendations from the dealers thus equipped. New England has also shown much activity in this connection. Several contracts have been closed for work in New Haven and Bridgeport. A record was recently made in quick installation in the case of Furer Bros., of Stamford, Conn. The complete installation was made and ready for business within two weeks from the time the order was received in New York. Mr. Van Veen has experienced a particular demand on the part of the dealer to have the booths installed under the personal supervision of his own skilled mechanics. The small extra cost entailed has been found to be thoroughly covered by the complete satisfaction of having the equipment rightly installed.

All dealers seem to recognize the value of proper equipment as a sales asset.

Room No. 321
130 Fulton Street
New York City

Clifford A. Wolf
MANUFACTURER OF
Diamond and Sapphire
Phonograph Points

Phone, 2812 Cortlandt

ROTTEN STONE

We are the only miners and manufacturers in this country of Rotten Stone for use in Phonograph Record making. Our product is now in use by practically every record manufacturer in this country. We are also headquarters for all other minerals for record making and everything we handle is made especially for this purpose and absolutely guaranteed. Expert advice given upon any formula.

KEYSTONE MINERALS CO.
41 Union Square, New York City

FROM OUR EUROPEAN HEADQUARTERS

2 GRESHAM BUILDING, BASINGHALL STREET E. C., LONDON, W. LIONEL STURDY, MANAGER.

British Music Trades' Industry Committee Studying Tariff Conditions to Protect English Manufacturers—Wm. Manson and H. Frederick Keen Added to Gramophone Co., Ltd., Staff—New Catalog—London Edison Society Formed—Victory Convention Held—Record Exchanges Discussed—"Winner" Records Selling Fast—Trade Rejoicing Over Lifting of Import Restrictions—Balcombe's United States Trip Delayed—Other News of Interest

LONDON, E. C., July 1.—There is no question about the removal of the import restrictions on musical instrument parts and accessories having created much interest and satisfaction throughout the trade. True, it is not altogether accepted as a matter for general satisfaction, owing to the peculiar position of those manufacturers whose immature plans are thus faced with a handicap of unexpected proportions. To such, the margin of protection afforded by the maintenance of 33 1/3 per cent. tariff duty is regarded as insufficient, at least until they are in a position to produce in bulk. That is perhaps natural. But while appreciating its local viewpoint, I think the manifold interests of the industry demand a broader basis of consideration. With every sympathy and every desire to further the interests and output of British productive effort, I am frankly convinced that the present import tariff is good enough margin of protection on manufacturing and market costs against Swiss, French, Italian, American or other imports. To maintain otherwise, now that the object of rationing imports (mainly to conserve shipping space) is unnecessary, would savour of a suspicion in the direction of profiteering and monopoly. By all

means let us avoid anything of that nature; it has so far been foreign to the British gramophone industry. If we start on the basis of selling goods subject to a reasonable gross profit, rather than the how-much-can-I-get policy adopted in all too many trades, healthy competition will not hurt us. The cost of materials and labor is more or less on a par throughout the world, and if in some quarters these attributes are easier than in England, signs are not wanting that equality is rapidly approaching as the result mainly of the great unrest permeating all ranks of labor. That being so, the prospect of increased foreign competition in the British markets should raise no undue alarm, providing our manufacturers maintain an enterprising policy and persistent effort in keeping with the times.

There is one form of protection, however, which we must absolutely insist upon, in addition to the tariff. I refer to the feared dumping of enemy products on the British market. To allow this would very severely handicap our present and prospective manufacturers of gramophones and their parts. The very high ruling prices of today must be fought against by every legitimate method, but we cannot expect production to attain such proportions as will permit of the lowering of prices if huge quantities of enemy goods—and doubtless big stocks are ready—are allowed import here at prices ruling, it is feared, at little above cost in order to turn-over the capital-value they represent. This matter is receiving the close attention of the British Music Trades' Industry Committee, and representations for increased tariff protection will be made to the Government, which, by the way, has already promised some

form of legislation to prevent the "dumping" of enemy stocks.

His Master's Voice Staff Changes

I am now able to supplement the report in our last issue concerning the resignation of M. E. Ricketts from the position of British sales manager of the Gramophone Co., Ltd., and the appointment of Wm. Manson in his place.

By his unfailing energy and conspicuous commercial ability, Mr. Ricketts enjoys a well-merited reputation with "His Master's Voice" clientele, and in his new position as manager of the piano branch of the House of Chappell there is ample scope for the exercise of his firm belief in the future of British pianofortes. He is a veritable genius in organization and the creation of successful selling campaigns. Mr. Ricketts commences his new task with the hearty good wishes of all his music trade friends, who will not soon forget the invaluable aid and advice always freely at their disposal in matters of grave concern continuously arising throughout the whole war-period of official trade control.

In taking up the reins thus relinquished by Mr. Ricketts, Wm. Manson brings to bear an experience of the gramophone trade second to none. As manager of the British Zonophone Co., Ltd., for the past eleven or twelve years, he has gained an unrivaled knowledge of the manifold desiderata involved in the production and marketing of a quality record, the successful accomplishment of which bespeaks a happy result all round for the Gramophone Co.'s choice of Mr. Manson as their new sales manager.

It is no light task Mr. Manson has undertaken, as he is retaining the managership of the British

(Continued on page 166)



"His Master's Voice"

Copyright

This intensely human picture stands for all that is best in music

—it is the "His Master's Voice" trade-mark, and it brings to you, no matter where you are, the very best music of every kind, sung and played by the world's greatest artists—the greatest singers, pianists, violinists, orchestras and bands—all enshrined in the unequalled "His Master's Voice" records

'His Master's Voice'

—the trade-mark that is recognized throughout the world as the

HALL-MARK OF QUALITY

Branches

DENMARK: Skandinavisk Grammophon-Aktielselskab, Frihavne, Copenhagen.

FRANCE: Cie. Française du Gramophone, 115 Boulevard Richard Lenoir, Place de la République, Paris.

SPAIN: Compañía del Gramófono, 56-58 Balmes, Barcelona.

SWEDEN: Skandinaviska Grammophon-Aktiebolaget, Drottning Gatan No. 47, Stockholm.

RUSSIA: The Gramophone Co., Ltd., 45, Nevsky Prospect, Petrograd (Petersburg); No. 1 Solyanka, Solyanoi Dvor, Moscow; 9, Golovinsky Prospect, Tiflis; Nowy-Swiat 30, Warsaw; 11 Michalovskaya Ulitsa, Baku.

INDIA: The Gramophone Co., Ltd., 139, Balhaghatta Road, Calcutta; 7, Bell Lane, Fort Bombay.

Great Britain:

The Gramophone Company, Ltd.

HAYES - MIDDLESEX - ENGLAND

Agencies

AUSTRALIA: S. Hoffnung & Co., Ltd., Sole Concessionaries of The Gramophone Company, Limited, 163, Pitt Street, Sydney.

NEW ZEALAND: Gramophonum, Ltd., 118-120 Victoria Street, Wellington.

SOUTH AFRICA: Darter & Sons, Post Box 174, Capetown; Mackay Bros., Post Box 251, Johannesburg; Mackay Bros. & McMahon, Post Box 419, Durban; Ivau H. Haarburger, Post Box 105, Bloemfontein; Franz Moeller, Post Box 108, East London; B. J. Ewins & Co., Post Box 88, Queens-town; Handel House, Kimberley; Laurence & Cope, Post Box 132, Bulawayo; The Argus Co., Salisbury.

EAST AFRICA: Bayley & Co., Lourenzo Marques.

HOLLAND: American Import Co., 22a, Amsterd Veerkade, The Hague.

ITALY: A. Bessi & Co., Via Orefici 2, Milan.

EGYPT (Also for the Soudan, Greece and the Ottoman Empire): K. Fr. Vogel, Post Box 414, Alexandria.

EDISON BELL

WINNER
 TRADE MARK
 GRAMOPHONE RECORDS

 CABLE
 "PHONOKINO,
 LONDON"

ARE THE GREATEST VALUE FOR MONEY PRODUCED IN GREAT BRITAIN

TEN INCH

DOUBLE SIDED

NEEDLE CUT

PLAY ON ALL GRAMOPHONES

Catalogue contains 4000 Titles by the Premier Artistes, Instrumentalists, Orchestras and Bands of the British Empire

DEALERS PREPARED TO DO BUSINESS ARE INVITED TO COMMUNICATE WITH

Proprietors and Manufacturers, J. E. HOUGH, Ltd., 62 Glengall Road, London, S. E. 15, England
FROM OUR LONDON HEADQUARTERS—(Continued from page 165)

Zonophone Co., Ltd., in which, however, he will have the services of a fully qualified assistant. In congratulating Mr. Manson upon his additional appointment as manager of the British sales branch of "His Master's Voice" Co. I am but echoing the sentiments of all those in the trade, and they are legion, who know and respect Mr. Manson for his honesty of purpose, business acumen and courtesy to all men.

H. Frederick Keen, I learn, will in future take sole charge of the "His Master's Voice" advertising department. This appointment follows his relinquishment of a similar position with the British Zonophone Co., Ltd., in favor of V. H. Lloyd, who has now entered upon his duties. No better example of art allied to advertising could be found in the whole talking machine field than the Zonophone method of publicity, for which Mr. Keen was responsible. More than once it has been descanted upon in these columns as distinctive in the thought and experience its lay-out, choice of types, the sales-winning appeal of its text indicate. In the application of advertising, and in its study, Mr. Keen's work expresses a modern line of appreciation of the value of this ancient channel of commerce it is always up-to-date and, above all, convincing. Congratulations!

"His Master's Voice" New Instrument Catalog

Owing to the vast amount of war work undertaken by the Gramophone Co. during the last four years or more, the production of gramophones was more or less reduced, from the dealers' viewpoint, to starvation diet. The reason is fully known and I believe fully appreciated by the company's agents throughout the kingdom, who, for the most part, have remained loyal to the "His Master's Voice." And now one can imagine with what enthusiasm they will welcome a return to normal supplies. Since the armistice or as soon thereafter as officially permitted, the company's huge factories at Hayes

have been under careful reorganization. The change-over from war to peace output has necessitated considerable rearrangement of the machine shops and the installation of balancing items preparatory to resumption of the manufacture of motors, tone arms and other fittings. While not entirely accomplished, sufficient has been done in the way of single-spring motor production to warrant the issue of a new instrument catalog, with, of course, the prospect of immediate deliveries. The folder before me illustrates some beautiful models of the Cabinet Grand (four designs), Table Grand (three), hornless (four), and exterior horn (three). The woods used are mainly oak and mahogany, and the equipment is of the usual "His Master's Voice" high standard of workmanship, finish and quality through. "Some" business this next season, for sure!

Formation of the London Edison Society

Phonograph enthusiasts—members of various London talking machine societies—have evinced keen interest in the idea of a joint association to be known as the London Edison Society, its objects being social intercourse between its members, in addition to the scientific and musical study of sound-reproducing apparatus, and its application. Formation has been completed after considerable negotiation and meetings between the officials of all the London talking machine societies. Thomas A. Edison has been invited to accept the presidency. Headquarters have been chosen at the Food Reform Restaurant, Furnival street, Holborn. To the chairman, Norman F. Hillyer, and other officials of the London Edison Society, we would tender our congratulations upon the fruition of their efforts to consolidate and maintain the interests of those whose loyalty to the cylinder has remained unshaken, even throughout the war period when new Edison records were unobtainable.

From all we hear, by the way, it seems likely that the Edison Corporation will in the future concentrate almost exclusively upon disc output for this market at any rate. There is, however, little prospect of early future consignments in bulk, owing, as we are given to understand, to the American demand being so much ahead of actual available supplies. For such a super-quality record as the Edison, there is ample scope this side for big business, and the sooner it is looked after the better. A wish and a want echoed by all Edisonists.

The Cake is Awarded

to a writer in a London talking machine paper for a curious journalistic lapse. Speaking of the musical side of garden parties, etc., and the value of the gramophone at such functions, the writer refers to an occasion when a tennis game being on, considerable filip was given to the play by the use of a gramophone brought along by a visitor, and goes on to say that " . . . the host, not being the possessor of an instrument himself, was so ashamed with what he heard that he announced his intention of purchasing a gramophone . . ." It reads somewhat paradoxical, but the moral may be read by every dealer who is out to cultivate a large trade this summer season.

The British Music Convention

This year's Victory Convention will be held at Birmingham June 19 to 23, inclusive. Perhaps the chief subject on the agenda is the proposed "Federated Board of Music Industries of Great Britain and Ireland," in which ambitious scheme is centered a great amount of real enthusiasm. Its description is partly self-explanatory, and at some future date space may be found in this journal for a detailed account of the wide-sweeping objects the idea embraces. The Gramophone Association will be represented by M. E. Ricketts, president, and the vice-president, Frank Samuel. Also Louis Sterling, who will read a

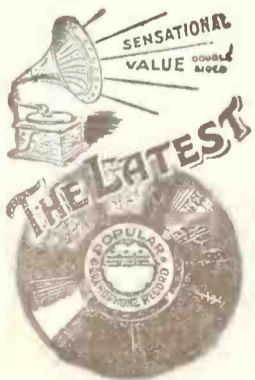
YE "POPULAR" RECORDS

 Double-Sided
 Superb Needle Cut
 "Lateral"

LONDON'S LEADING VALUE!!!
"OUR POINTS" }
 SET OUT BELOW

Have Attracted Keen Overseas Houses

 from SCANDINAVIA to PATAGONIA
 AND THE PRINCIPAL
 EAST and WEST MARKETS of the WORLD

REMEMBER You Can Have CLOSE QUOTATIONS

 For 5,000 Lots and up "Your Selection" or a Sample 1,000,
 made up with "One Example" of Every Catalogued Pairing.

 Address: **SOUND RECORDING CO., Ltd.** CABLES "Grammavox"
 EXPORT DEPT. 18-19 Swallow Street London
 Piccadilly, London, England "QUOTATIONS CABLED FREE"

POINTS

- ➔ Repertoire Approx 2,000 Titles—Covering
- ➔ Superb Selection, Bands and Orchestras
- ➔ Lightning Shipments
- ➔ Packing by Experts
- ➔ **Rock Quotations "Always"**
- ➔ F. O. B. London
- ➔ We attend to all Insurances "if Requested" to Buyers A/c
- ➔ Our Shipping Services, this Side **FREE**

APOLLO GRAMOPHONES

Apollo
Portable
with
Sound
Reflector



Every type of instrument with Horn, Hornless, Table Grand, Pedestal and Portable.

FINEST BRITISH WORKMANSHIP

Motors, Tone Arms, Sound Boxes and Accessories

AGENCIES OPEN FOR CERTAIN FOREIGN MARKETS

Write for lists and full particulars to the makers

CRAIES & STAVRIDIS, 4 BUNHILL ROW, LONDON, E.C.1.

FROM OUR LONDON HEADQUARTERS—(Continued from page 166)

paper entitled "Gramophone Trade Conditions in America." Mr. Samuel's contribution relates to "Small Goods Manufactured in Great Britain; Scope and Possibilities." A report will appear in this journal next month.

The Value of Record Exchange Schemes

There is, of course, a fine sales field for the average smart dealer to cultivate during the summer months, especially in the direction of the provision of music for outdoor entertainment. But all said and done, the present is perhaps the quietest time of the year, and it should therefore be taken advantage of for a general clean-up. Excluding the operations of the scrubbing brush, etc., those dealers who can manage it will call in the painters and have the whole place refurbished inside and out. The best sales magnet is a bright, clean and attractive shop.

But I am not so much concerned with this side of the question as the matter of stock. Recognizing that a fresh, up-to-date stock is the basis of retail success, most manufacturers offer the dealer at least one opportunity during the year to exchange broken, damaged or otherwise unsalable discs for new ones. The terms are usually on the basis of three to one. That is, the dealer must order three new records for every one returned, full credit being given for one, the other two being charged at the usual rates. The dealer must pay carriage on the records he returns for exchange. Now, without such a scheme, the small capitalized retailer's expenditure upon stock would not be at par with takings. A broad average estimate goes to show that something like a third of his money investment upon records is dead for much too long a period. He should at least turnover this capitalized record stock within a period of three to six months. More often than not the main part of it lays dormant until relief is found under one or the other of the periodical exchange schemes. So many ephemeral records

are issued, which the up-to-date dealer must stock, that he often finds himself overburdened with stuff of this class. Its sale is practically dead in three months' time or less. An accumulation of stock is all too rapidly gained, and dealers in such a position naturally find their future activities restricted unless advantage is taken to exchange on the basis mentioned.

Supposing the dealer to return 100 unsalable records, it means finding room for 300 new ones, in choosing which he is confined, be it remembered, to records already issued. Exercising the most careful choice, a percentage will be left which he must hold until he can again "afford" an exchange. In the matter of his salable stock, gradually decreasing because lack of sufficient capital reserve precludes a clean sweep of the old stuff, he must eventually find himself compelled to reduce his monthly orders for new records. The whole trouble rests in the fact that in taking advantage of the exchange retailers are forced to overload their stock by the manufacturers' stipulation that the new records must be chosen from existing lists. It is just this restriction which mars an otherwise equitable proposition. There is a fair remedy, I think, which would obviate the compulsion thus put upon dealers to mortgage their future orders. Returning, say, 100 records and having to order 300 in one or two weeks, at the outside, compels the average dealer to go slow for the following month or so. It might well be avoided by giving him the option to order, say, 200 during the period of the exchange and 100 from the next list issued.

While I appreciate that by confining the dealer to order from lists already issued, the manufacturers may hope to relieve their own stocks and avoid loss on the records issued during the month following the exchange, in the interests of sound business, it would be far better to take a long view, and attempt to neu-

tralize loss by compiling a specially attractive programme and perhaps create additional sales by increased advertising. In any case, exchange schemes are costly affairs, alike to the manufacturer and the dealer.

Having withdrawn about eighty records from their catalog, the British Zonophone Co., Ltd., recently gave their dealers an opportunity of exchanging any such records in stock for new ones on the basis of three to one. This is the first Zono exchange since the war, I believe, and it is reported a big success.

The Winner Co. also introduced an exchange scheme last month (June). It was on the 3 to 1 arrangement and applied only to any unsalable "Winners" dealers had in stock. This scheme does not affect in any way the permanent one, under which the Winner Company accepts as old junk all records (except Columbia) for exchange on the basis of one new Winner for every six scrap records returned.

New "Winner" Records in Popular Favor.

The usual careful choice of titles characterizes the latest Winner programme, which is also notable for the number of artists who record only for this company. In the latter category are over sixty per cent. of the issues. The Band of H. M. Irish Guards contribute three doubles comprising marches, fox trots and various gems from one of musical London's most popular productions, "Oh, Joy!" Another "exclusive" is made up of records by The Two Bobs, comedians of great ability and humor. Their class of selection is always calculated to raise a good laugh, and "Jingaboo Man" and "Torpedo Jim" are no exceptions to the rule. A good double by the Royal Court Orchestra gives a splendid presentation of the most acceptable airs from Darewski's latest success, "Buzz Buzz," and a couple of dreaming items of the waltz type are down to the credit of the Bohemian

(Continued on page 168)

Millions of Your "Boys" in France Heard the Scots Guards' and Hon. Artillery Company's Bands

When they come home it will be one of the pleasant memories of the "Great Adventure."

They will want to forget the "horrors of war" and recreate those rare occasions of happiness.

Then they will ask you, Mr. Dealer, for Gramophone Records of these two famous Bands.

Anticipate their wishes. The pleasure will be mutual.

A large selection by these two world-famed Bands and hundreds of Orchestral, Instrumental and Vocal pieces can be obtained on

GUARDSMAN RECORDS

10 AND 12 INCH LATERAL CUT

1 New Inn Yard, London, E. C. Write for Catalogs and prices to INVICTA RECORD CO., Ltd. Cables: Duarrab, London

GRAMOPHONES

Complete—Fittings—Sundries—Repair
Parts—Needles

Special Lines and Quotations for Export Trade

THE BRITISH POLYPHON CO.

Glasgow, Scotland
27 Jamaica St.

1, 2 and 3 NEWMAN STREET
LONDON, W. 1, ENGLAND

Band. The Elliotts, the Versatile Three, Dan Jones, Rita Squire, Stanley Kirby, and the one and only Billy Merson offer vocal numbers much in popular favor. It is altogether a real Winner list which has already received a great reception from both dealer and public.

A Gramophone Industry Benevolent Fund

In connection with the Victory Fund, which, by the way, is still open for subscription, the organizers announce the establishment of a Benevolent section, the idea being that our trade should at any time be in a position to financially assist those members of the industry who may require it by reason of unfortunate circumstances. The movement is making but slow progress and it is hoped that a fillip may result now that the scope of the Fund has been widened.

Tom Burke to Sing at Concerts.

As a result of his sensational success at the Covent Garden Opera, it is reported that the new tenor, Tom Burke, who records exclusively for Columbia, by the way, is being offered fees of three figures to sing at some provincial concerts. Few, if any, native artists can command such fees.

Trade Restrictions Removed—Other Notices

Of great importance to manufacturers of record material is the announcement of the issue of a general license permitting the importation of Stearine.

The Consultative Council on Imports has completed its work, and traders will be glad to learn that the Board of Trade have now issued an up-to-date list of the import relaxations and existing restrictions, in two parts: (1) The articles which may be imported without license from the Department of Import Restrictions, and (2) the articles which may not be imported without licenses from the department.

The relaxation of import restrictions applies to all parts of gramophones. There seems to have arisen some question as to whether gramophone needles would come under the heading of a "part" or of steel. The former, of course!

Another announcement withdraws the prohibition against trading with firms or persons on the various blacklists published from time to time. As a matter of fact the Board of Trade have issued a general license authorizing persons in the U. K. to open credits on behalf of persons or bodies of persons (as the official ad-

FROM OUR LONDON HEADQUARTERS—(Continued from page 167)

vice quaintly reads) in enemy countries for the purpose of financing transactions that have been authorized under the Trading with the Enemy legislation in the U. K. or any other part of his Majesty's Dominions, and transactions between persons residing or carrying on business outside his Majesty's Dominions which have been authorized by the allied and associated Governments or any of them.

Announcement is made by the Foreign Trade Department that articles for export may now be consigned to all and any persons and firms in China and Siam.

H. M. Customs have been advised that all export licenses are to be considered of unrestricted validity even though a time limit for shipment may be stated thereon.

The official administrator for Palestine announces that a good market is open for British merchants. He would welcome the receipt of catalogs and facilities for consultation will be given to interested parties in Jerusalem, Jaffa and Haiffa. Musical instrument catalogs are specifically mentioned, and should be addressed to Headquarters, Economic Section, O. E. T. A., Jerusalem, Palestine. In pre-war times enemy goods obtained a strong hold in this market. Rumor has it that the Japanese merchants are now making a big onslaught in near-Eastern fields, and to British firms the Palestine administration's good advice to cultivate this market therefore comes at a most opportune time.

Apropos this question of trade cultivation of the near-Eastern markets, an opportunity is now open for British musical instrument makers to take part in the British Manufacturer's Exhibition to be held next October and November at Athens, promoted by the Federation of British Industries, 39 St. James St., London, S. W. 1. Early application is desirable.

Miscellaneous Items of General Interest

A. J. Balcombe's proposed visit to America has been postponed. The trip was planned at the instance of the Otto Heineman Corporation, whose many lines of gramophone goods Mr. Balcombe will handle this side as sole agent for Great Britain and Ireland. Partly owing to the late arrival of sample consignments of motors, due to shipping congestion, there has been no opportunity of showing them to the trade. The postponement of his visit until July 20 (provisional sailing date) will now afford Mr. Balcombe a chance of sizing up the situation and sales prospects. Armed with this information, his negotiations can be conducted upon a more satisfactory basis. It is understood that if conditions warrant the Heineman people will consider laying down a motor plant and record factory in England.

Cross Seas Parcel Post

In urging British manufacturers to cultivate trade in the Scandinavian markets, the Secretary of the Gramophone Association gives currency in his latest Bulletin to an alleged statement by an American traveler that "We mean to push

the business right along, and when England is ready there'll be nothing left for her to do."

From the same source we learn that there are two parcel post services between England and the U. S. A.—the official and the semi-official. The official is the one recommended so long as the regulations as to weight and size are complied with, as the packages through that service are delivered direct by the U. S. A. authorities without formal customs entry; whereas by the semi-official service Custom House entry and the employment of a broker are involved.

An American Visitor

Among distinguished visitors who are looking around the trade this side is Mr. Landay, of the American house of Landay Bros. His views on the trade situation may be available for report next month.

Tell Me the Old, Old Story

A funny yarn has come to light here concerning the manager of a talking machine recording firm. Some time back a New York music publishing house issued a new setting, it is said, of Ben Jonson's "Drink to Me Only With Thine Eyes." An advertisement of it came under the notice of our recording friend, who promptly remitted a note to "Ben Jonson, Esq." care of the publishers, offering for a suitable consideration to include his new song in their record catalog. The letter never reached Ben, but his spirit radiated "some" smile, you bet.

The Educational Value of the Gramophone

Due to the war and perhaps air-raids, lectures were more or less abandoned for want of audiences. This pleasant and educational form of recreation and instruction is now gradually making a welcome return. An appreciative audience was drawn to hear Harold Wild's recent lecture on the "History of the Orchestra and Orchestral Music," in which, by the way, he introduced a Gramophone to demonstrate the theme of his interesting discourse. He couldn't bring this and that well-known orchestra, but he nevertheless delighted his audience with records of their brilliant orchestral work. It is said that the records created a great impression in an educational respect.

Among the recent visitors at the Columbia executive offices were T. E. Shortell and Mrs. Shortell, R. Sayre, Miss Werhle and Miss McLean, of the S. Hamilton Co., Pittsburgh, Pa., Columbia dealers. These visitors spent some time at the Columbia factories in Bridgeport

TO MANUFACTURERS

AGENCY WANTED
for
GRAMOPHONE
MOTORS, CABINETS
AND ACCESSORIES

Forward full particulars, with illustrations, Agency terms, and deliveries to Box 11845, c/o A. J. Wilson & Co., Ltd., 154 Clerkenwell Road, London, E.C.1, England.

REX GRAMOPHONE CO.

are making a Specialty of

EXPORT

in

Horn, Hornless & Portable Disc Machines

REX GRAMOPHONE CO. 2 Elizabeth Place
Rivington Street, LONDON, E.C. 2

Cable Address "Lyrecodisc, London"

Enquiries Solicited

LATEST PATENTS RELATING TO TALKING MACHINES AND RECORDS

WASHINGTON, D. C., July 8.—PHONOGRAPH.—Clinton B. Repp, New York, assignor by mesne assignments to G. H. Alonso, same place. Patent No. 1,302,433.

The main object of this invention is to provide a phonograph wherein the indicated sound waves are transmitted through a vibrator member to a diaphragm placed under tension through said vibratory member, wherein the direction of the application of stress or pressure upon the diaphragm may be varied to adapt the machine to use with records wherein the indicated sound waves have a vertical undulation, or records wherein such indicated sound waves have a lateral undulation. A further object is to provide in a machine of this character means applying pressure upon the stylus point through an auxiliary supporting or controlling arm, the connecting means between this arm and the vibratory member being so constructed as to permit that change in the position of the vibrator member incidental to the change in the direction of the application of pressure there through to the diaphragm. A still further object is to provide a machine of this character wherein any variance in the arcs described by the vibrator member and by the auxiliary supporting or controlling arm will be automatically compensated for in a manner to avoid any false tone in the reproduced sounds. A still further object is to provide a machine of this character wherein the pressure will be placed upon the diaphragm by means of a spring and a loop member capable of movement relative to the diaphragm, the means tensioning the said spring being capable of such adjustment as to vary the direction of the application of pressure without materially varying the degree of such pressure. A still further object is to provide a machine of this character wherein the auxiliary controlling or supporting arm will be so supported and will have the requisite pressure so applied thereto, through the spring, as to avoid the development of independent vibrations in said spring or any retardation of said arm in following the indicated sound waves upon a record under the control of the vibrator member. A still further object is to provide in a machine of this character a concealed horn so constructed and arranged relative to the sound box as to permit said horn to have vertical movement relative to the sound box without disconnecting the horn from the sound outlet of said box. A still further object is to provide in a machine of this character a concealed horn so related to the outlet of the sound box as to

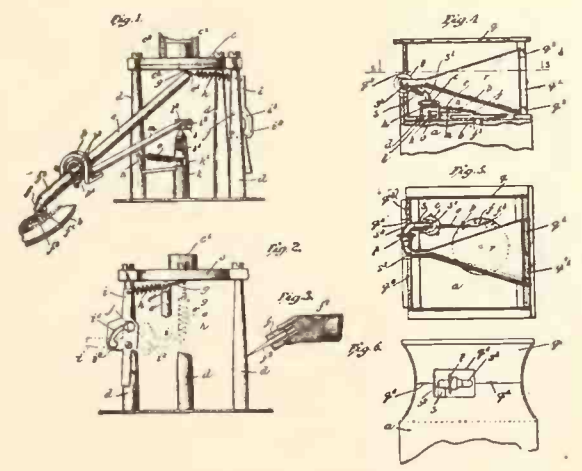

permit the concealed horn to be disconnected from said outlet and the substitution of an ordinary horn therefor. And a still further object is to provide a machine of this character, the various parts of which will be so constructed and arranged as to minimize likelihood of the development of such vibrations as would interfere with or impair the sound vibrations indicated upon the record passing to the diaphragm while permitting the machine to be economically produced.

Referring to the drawing: Fig. 1 is a front view in perspective of the sound reproducing means of the improved phonograph. Fig. 2 is a rear elevation thereof. Fig. 3 is a detail view of the mount of the vibrator member. Fig. 4 is a vertical section through the cabinet, showing the sound reproducing means in elevation. Fig. 5 is a horizontal section on the line 5—5 of Fig. 4, showing the horn in elevation, and Fig. 6 is a rear view of the upper part of the cabinet.

TONE ARM FOR TALKING MACHINES.—James F. Smith, St. Louis, Mo., assignor of one-third to Anthony F. Ittner and one-third to Arthur H. Bradley, same place. Patent No. 1,302,478.

This invention relates to tone arms for talking machines, and particularly to tone arms used in connection with sound boxes of the type shown in pending application Serial No. 105,141, filed June 22, 1916. The present application is a division of said application Serial No. 105,141.

The objects of the invention are to provide an inexpensive tone arm for talking machines which is neat in appearance and of simple construction. Another object is to provide a flexible mount for the tone arm, whereby it is free to move laterally and vertically within suitable limits.

Figure 1 is a plan view of a tone arm and sound box embodying the invention. Fig. 2 is a side elevation of the tone arm and sound box shown in Fig. 1. Fig. 3 is a vertical cross-section of the tone arm taken on the line 3—3

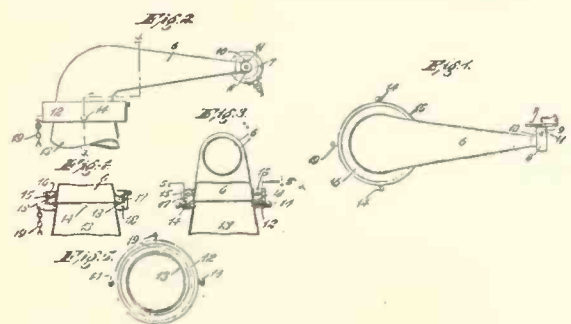

in Fig. 2. Fig. 4 is a vertical cross-section of the flexible joint for the tone arm taken at right angles to Fig. 3, and Fig. 5 is a horizontal section through the tone arm on the line 5—5 in Fig. 3.

SOUND BOX FOR TALKING MACHINES.—James F. Smith, St. Louis, Mo., assignor of one-third to Anthony F. Ittner and one-third to Arthur H. Bradley, same place. Patent No. 1,302,479.

The invention relates to sound boxes for talking machines of the type shown in pending application filed June 22, 1916, Serial No. 105,141, and particularly concerns the stylus lever construction and its adjustable mount.

The objects of the invention are the elimination of incidental noises and the improvement of the tone qualities and volume of sound produced. Further objects are to provide for the adjustment of the pitch and the loudness of the tone, and to arrange for the proper mounting of the sound box with relation to the record for satisfactory operation with all kinds of records.

The invention consists in a stylus lever and a spring mounting therefor, permitting adjust-

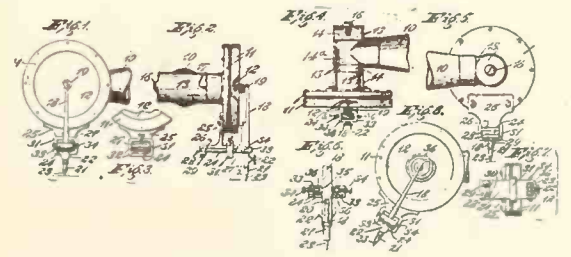

ment for sensitiveness and amplitude of the vibrations of the stylus. The invention also consists in the details of the connection between the sound box and tone arm.

Figure 1 is a face view of a sound box and tone arm connection embodying one form of the invention. Fig. 2 is a side view of the

same. Fig. 3 is a cross section on the line 3—3 in Fig. 2, looking in the direction indicated. Fig. 4 is a plan view of the sound box shown in Fig. 1, the tone arm being shown in central horizontal cross section. Fig. 5 is a back view of the sound box, showing a portion of the tone arm. Fig. 6 is an enlarged vertical sectional view of the pivoted portion of the stylus lever. Fig. 7 is a bottom plan view of the spring support for the stylus lever, and Fig. 8 is a face view of a modified form of stylus lever, the device being shown in position to play records having lateral undulations.

PHONOGRAPH HORN.—Elmer L. Kenyon, Chicago, Ill. Patent No. 1,303,208.

This invention relates to sound intensifying horns and particularly to means for clarifying the tone delivered by such horns and to avoiding the confusion thereof, incident to the use of these horns as heretofore made.

It is the object of the invention to remedy the defects and disadvantages above described and to produce a horn, particularly applicable for intensifying fine and delicate music, in which extraneous audible tones will be diminished and in which clash or confusion of different parts of the horn at the same time instead of producing a perfect response to the music will be rendered impossible.

It is a further object therefore to prevent this excessive vibration at the end of the horn, first, by tightly binding said end to the body of the horn, or second, to weight the end of the horn, or both, whereby the particles at the end of the horn will be prevented from vibrating excessively, but will have their vibrations brought into uniformity with those in the body of the horn, thus eliminating any interfering vibrations and encouraging those that improve the quality of the music.

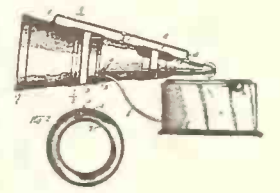

It is a still further object of the invention to suspend each section of a horn made according to the invention in such a position as to interfere as little as possible with its freedom to vibrate as the music demands.

In the drawings Figure 1 is an elevation, partly in section, of a phonograph equipped with a horn built according to the invention. Fig. 2 is a cross section on the line 2—2 of Fig. 1.

PHONOGRAPH RECORD.—George Leake, Mason City, Ia. Patent No. 1,303,074.

The device forming the subject matter of this application is a record for a phonograph and the invention aims to provide a structure of the kind mentioned which may be played continuously, by reversing the direction of rotation of the record.

It is within the province of the disclosure to improve generally and to enhance the utility of devices of that type to which the present invention appertains.

In the accompanying drawings Figure 1 is a top plan showing one form of record constructed in accordance with the invention; Fig. 2 is a fragmental section taken longitudinally of one

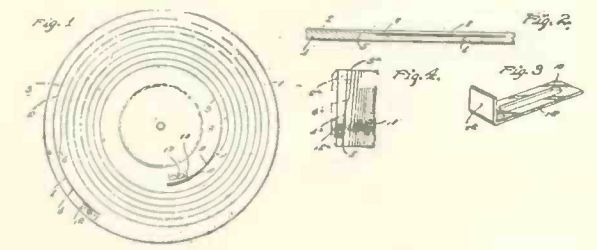

of the grooves; Fig. 3 is a perspective showing the projection or stop which operates the reversing mechanism; and Fig. 4 is a fragmental elevation showing a slight modification in the invention.

SOUND REPRODUCING MACHINE.—Francesco Ci-relli, Philadelphia, Pa Patent No. 1,302,900.

This invention relates to improvements in sound reproducing machines, the object of the invention being to provide a machine of the character stated which dispenses altogether with the ordinary horn, which may be readily carried

(Continued on page 170)

from place to place, and occupy but relatively small space.

A further object is to provide an improved construction of box in which the sound waves are directed by a tone arm into a chamber having perforated walls located at one end of the box, leaving a chamber at the other end, or front portion of the box, for the turntable and record discs.

A further object is to provide a sound reproducing machine of the character stated which provides a drawer for the accommodation of the tone arm and sound box when disconnected from normal position, and permits the assemblage of record discs on the turntable where they can be conveniently supported when the machine is to be moved from place to place.

In the accompanying drawings Figure 1 is a perspective view illustrating the improvements. Fig. 2 is a view in longitudinal section. Fig. 3 is a view in transverse section. Fig. 4 is a view in section on the line 4-4 of Fig. 2, and Fig. 5

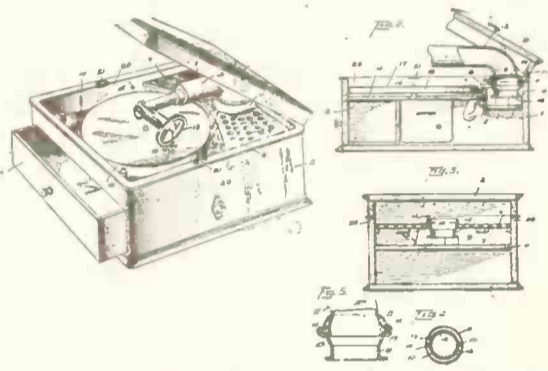

is a fragmentary sectional elevation showing certain of the coupling parts in register with each other.

POST CARD.—Shirley E. Stout, Mitchell, S. D. Patent No. 1,303,842.

This invention is an improvement in post or other cards and has particular reference to a card on which sounds may be recorded and answers reproduced.

An object of the invention is the production of a card having a portion thereof provided with a record-receiving surface and which, after having a record groove formed in said surface, may be readily and safely forwarded by post, whereupon the recipient may reproduce the message thereon.

Another object is to provide a recorder-reproducer which is used in connection with a talking machine for making and reproducing a sound record groove, means being employed in connection with the post card and recorder for guiding the stylus of the latter.

Figure 1 is a side elevation of the recording and reproducing apparatus, the post card being shown in transverse section. Fig. 2 is a vertical longitudinal section of the recording and reproducing sound boxes. Fig. 3 is an elevation of the recording sound box, the post card being shown in fragmentary section. Fig. 4 is a fragmentary top plan view of the post card, the recorder being shown diagrammatically. Fig. 5 is a plan view of a blank card. Fig. 6 is a section on the line 6-6 of Fig. 5. Fig. 7 is a view

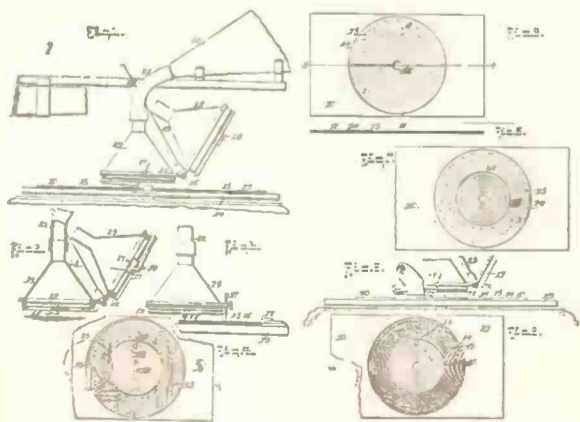

similar to Fig. 5 showing a guide disc used in connection with the card when recording, or reproducing. Fig. 8 is a side elevation of the turntable of a talking machine, the post card being mounted thereon and engaged by the recording stylus. Fig. 9 is a top plan view similar to Fig. 7 showing a record groove thereon in dotted lines.

PHONOGRAPH.—Frank A. Lee, Cincinnati, O., and Frank G. Rose, Dayton, Ky., assignors to the John Church Co., Cincinnati, O. Patent No. 1,303,686.

This invention relates to megaphones for phonographs or graphophones. The object of the invention is to intercept and throw back at varying angles the sound waves which would otherwise pass directly from the throat of the megaphone directly out through the mouth thereof, so that these waves strike either against the sides of the megaphone or the throat thereof, and, thus traveling a longer distance and striking vibrating surfaces, are enriched and clarified in tone. The further object of the invention is to take advantage of the vibration of the surfaces against which the sound-waves strike to further enrich and clarify the tone of the apparatus.

In the drawings Figure 1 is a general perspective view of a phonograph provided with the improvement. Fig. 2 is a longitudinal vertical section of the megaphone and throat, the latter being modified from that shown in Fig. 1. Fig. 3 is a detail perspective view of the improvement, as shown in Fig. 1, but with an-

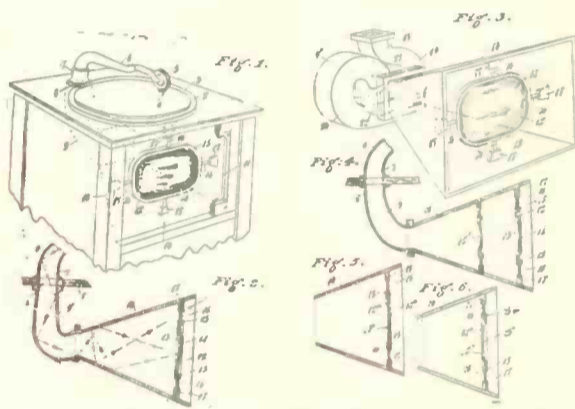

other modified throat. Fig. 4 is a section similar to Fig. 2, but showing the throat of Fig. 1, and showing a plurality of deflectors in the megaphone; and Figs. 5 and 6 illustrate modified deflectors.

ATTACHMENT FOR TALKING MACHINES.—Raymond R. Rundell, Alfred E. Ogden and Frederick S. Ellett, Elmira, N. Y. Patent No. 1,303,502.

This invention relates to a device which may be attached to the existing and standard forms of talking machines and has for its purpose the effecting of a retarding action of the downward movement of the sound box tube or movable horn arm of a Victrola, should the said sound box be accidentally or prematurely released while the stylus is being lowered and adjusted in position on a record, thereby preventing any possible injury to the stylus or scratching or mutilation of the record.

The objects of this invention are to provide an attachment of the character above indicated which comprises a minimum number of parts capable of being easily and cheaply manufactured, repaired and assembled, and at the same time enable the same to be readily and quickly attached to the standard talking machines without in any way disturbing or altering the organization and arrangement of the parts of the talking machine to which said attachment is connected.

Figure 1 is a plan view partly in section of a taper tube and sound box tube of a Victrola with the invention attached. Fig. 2 is an enlarged sectional view taken on line 2-2 of Figure 1. Fig. 3 is an enlarged sectional view taken on line 3-3 of Fig. 1. Fig. 4 is a per-

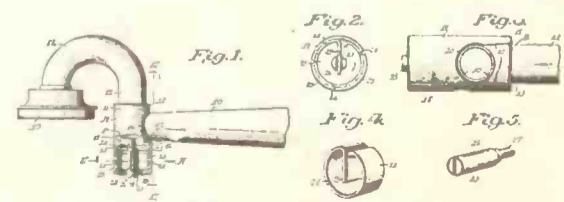

spective view of the retarder spring disconnected from the attachment; and Fig. 5 is a perspective of the slotted stud forming a part of the invention.

AUTOMATIC LID SUPPORT.—Carl Edward Wilton, Philadelphia, Pa. Patent No. 1,303,441.

This invention relates to the class of de-

vices used on such articles as phonograph cabinets for maintaining the top or lid thereof in open position against inadvertent closing. The object of the invention is to produce such a device that is very simple yet positive and dependable in action and a device that may be installed with a minimum of expense.

Figure 1 shows a side elevation of the device in place on phonographs. Fig. 2 shows a perspective view of the bracket and with the cam in place. Fig. 3 shows a vertical section taken in the plane of the pivot of the cam. Fig. 4 shows a side elevation of the cam. Fig. 5 is an edge view of the bar; and Fig. 6 is a side view of the same. Fig. 7 is a view similar to Fig. 1, but with a modified form of the device. Fig. 8 is a view of the bracket in this modified form. Figs. 9 and 10 show the different positions the cam of this form assumes. Fig. 11 shows a side view of the modified bar; and Fig. 12 is an edge view.

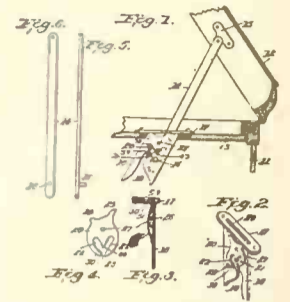

TALKING MACHINE.—Alfred J. Swing, Cincinnati, O. Patent No. 1,304,404.

This invention relates to improvements in talking machines. One of its objects is to provide improved tone arm and reproducing apparatus to adjust the reproducing apparatus into and out of operative relation with the record. Another object is to attain in an adjustable mechanism a more direct and nearly straight path for the sound vibrations from the reproducing mechanism to the megaphone. Another object is to provide for the protection of the reproducing mechanism in its inoperative position and to enable a shallow lid or cover to be employed.

Another object is to attain improved angular positions of the stylus with reference to the record for either lateral or hill and dale types of record and for adjustments to both positions. Another object is to provide an improved pivotal mounting and adjustment for the tone arm to facilitate the travel of the reproducer across the face of the record.

Figure 1 is a plan view of a talking machine record and tone arm embodying the improvements, with the reproducer in operative position. Fig. 2 is a side elevation partly in vertical section, illustrating the pivotal bearing for the

tone arm in central vertical section and the reproducer in idle position with the casing lid closed.

Figure 3 is an enlarged detail of the reproducer illustrating the adjustment of the stylus to engage records of different type.

Figure 4 is a detail illustrating the angular position of the reproducer with reference to laterally-cut records.

Figure 5 is a view similar to Fig. 4 illustrating the position of the reproducer and stylus with reference to the hill and dale type of records.

Figure 6 is an enlarged sectional detail on line v-v of Fig. 3, illustrating the pivotal mounting for the stylus.

John Spillane, of the Blackman Talking Machine Co., New York, attended the recent Elks' convention at Atlantic City.

LESLEY'S PATCHING VARNISH

dries in 10 seconds, flows without showing the lap. With it damaged varnish can be repaired invisibly. New price 1 pt. \$1; 1 qt. \$1.50. Complete repair outfit \$3.50. F.O.B. Indianapolis, Ind. LESLEY'S CHEMICAL COMPANY, Indianapolis, Ind.

John Spillane, of the Blackman Talking Machine Co., New York, attended the recent Elks' convention at Atlantic City.

LESLEY'S
PATCHING VARNISH
dries in 10 seconds, flows without showing the lap. With it damaged varnish can be repaired invisibly. New price 1 pt. \$1; 1 qt. \$1.50. Complete repair outfit \$3.50. F.O.B. Indianapolis, Ind. LESLEY'S CHEMICAL COMPANY, Indianapolis, Ind.

ADVANCE RECORD BULLETINS FOR AUG., 1919

AEOLIAN CO.

- OPERATIC SELECTIONS
54022 La Forza del Destino—La vita e Inferno all' infelice (Life is misery to the unfortunate) (Verdi). Tenor, in Italian, Vocalion orch. accomp.
50004 La Boheme—Soave fanciulla (Thou Sweetest Maiden) (Puccini). Soprano and tenor duet, in Italian, Vocalion orch. accomp.
50005 Rigoletto—Povero Rigoletto (Alas Rigoletto) (Verdi). Baritone, in Italian, Vocalion orch. accomp.
30029 Chanson d' Amour (Song of Love) (Hollman). Soprano, in French, cello obligato, Marie Sundelius
22027 A Dream (Bartlett). Tenor, Vocalion orch. accomp.
22028 Friend of Mine (Sanderson). Baritone, Vocalion orch. accomp.
12155 Tell Her I Love Her So (deFaye). Tenor, Vocalion orch. accomp.
CONCERT BAND SELECTIONS
12156 Lucia—Sextette (Donizetti)
Cavalleria Rusticana—Intermezzo (Mascagni),
INSTRUMENTAL SELECTIONS
32010 Angels Serenade (Braga). Cello, piano accomp.
Melodie (Elegie) (Massenet). Cello, piano accomp.
12157 Narcissus (Nevin)
The Flatterer (Chaminade)
SACRED SELECTIONS
12158 Oh Morning Land (Phelps). Orch. accomp.
Calvary (Darwood-Sweeney). Orch. accomp.
DRAMATIC READING
12159 Puck Fanshaw's Funeral, from "Roughing It" (Mark Twain).
How Washington Chopped the Cherry Tree (Leo Carillo).
NOVELTY SELECTIONS
12160 A Bird Symphony (Ring-Hager). Vocalion orch. accomp.
The Little Whistler (Ring-Hager). Vocalion orch. accomp.
POPULAR SELECTIONS
12161 When I Met You (Klickman). Tenor, orch. accomp.
Some Sunny Day (Jackson-Donaldson). Tenor, orch. accomp.
12162 Oh, Oh, Oh, Those Landlords (Halsey Mober). Orch. accomp.
Take Me to the Land of Jazz (Welding). Orch. accomp.
12163 Gates of Gladness (Brennan-Cunningham-Rule). Orch. accomp.
Roses of Twilight (Ben Black). Orch. accomp.
NOVELTY DANCE SELECTIONS
12164 Where the Lanterns Glow (C. L. Johnson). Fox-trot.
Sand Dunes (Byron Gay). One-step.
DANCE SELECTIONS
12165 Karavan (Wiedoft). Fox-trot.
Enid Waltz (Mary Earl).
12166 Ruspana (Mary Earl). One-step.
Buddha (Pollack). Fox-trot.
12167 Miss Trombone (A Slippery Rag) (Fillmore). Fox-trot.
Old Glory Goes Marching On (Klickman). One-step.

COLUMBIA GRAPHOPHONE CO.

- A2746 I'll Say She Does, from "Sinbad" (Sylvia, Kahn and Jolson). Orch. accomp.
A2744 Friends (Santly). Male trio, orch. accomp.
I'm Going to Climb the Blue Ridge Mountains Back to You (McConnell). Tenor duet, orch. accomp.
A2745 Jazz Baby (Jerome). Comedienne. Orch. accomp.
I Ain't Got'en No Time to Have the Blues (H. Von Tilzer). Tenor duet, orch. accomp.
DANCE RECORDS
A2747 Mammy's Lullaby (Roberts). Waltz.
The Red Lantern (Fisher). Medley fox-trot.
A2742 Just Another Good Man Gone Wrong (McDonald and Osborn). Medley fox-trot.
A2741 Tears (Of Love). Henry and Warren. Medley one-step.
Yama Yama Blues (Williams and Williams). Medley fox-trot.
JULY MID-MONTH LIST
ON SALE JULY 10, 1919
These are the regular August records which go on sale July 10 and will go on sale again July 19. Watch your supplies of these popular numbers.
POPULAR HITS
A2746 I'll Say She Does. Al Jolson
Just As We Used To Do. Billy Murray

- A2745 Jazz Baby. Agnes Lynn
I Ain't Got'en No Time to Have the Blues, Irving and Jack Kaufman
A2744 Friends. Sterling Trio
I'm Going to Climb the Blue Ridge Mountains Back to You. Campbell and Burr
DANCE RECORDS
A2747 Mammy's Lullaby. The Happy Six
The Red Lantern. Medley fox-trot.
A2742 Just Another Good Man Gone Wrong. Medley fox-trot.
A2741 Tears (Of Love). Medley one-step.
Yama Yama Blues. Medley fox-trot.
You're Some Pretty Doll. Jockers Dance Orchestra

EDISON RE-CREATIONS

- 83051 Le Toreador (The Toreador)—Variations (Adam) Soprano, in French. Alice Verlet
Valse—(Waltz Song)—Romeo et Juliette (Gounod) Soprano, in French. Alice Verlet
83083 Panis Angelicus (Bread of Angels)—Messe Solennelle (Franck) Tenor, in Latin. Jacques Urlus
Vivrai! Contende il giobilo (Oh Joy! He's Saved)—Il Trovatore (Verdi) Soprano and Baritone, in Italian. Marie Rappold and Taurino Parvis
82563 Io non sono più l'Annetta (No longer am I Annetta)—Crispino e la Comare (L. and F. Ricci) Soprano, in Italian. Frieda Hempel
Solo, profugo (Lost, Proscribed)—Martha (Flotow) Tenor and Bass-Baritone in Italian. Karl John and Arthur Middleton
82564 Oh Promise Me—Robin Hood (De Koven) Contralto. Carolina Lazzari
Sweetest Story Ever Told (Stults) Contralto, Carolina Lazzari
80457 Little Whistler (An Idyll) (Ring-Hager) Whistling. Sibel Sanderson Fagan
Simplicity Intermezzo (Lee) Whistling, Sibel Sanderson Fagan
80467 Wishing That Dreams Would Come True (Logan) Baritone. Edward Allen
Won't You Come Back to Me (Jacobs) Soprano. Leola Lucey
80469 Dusky Lullaby (Gilbert) 1st Soprano, 2d Soprano and Alto. Homestead Trio
The Glow-Worm (Lincke). We Girls Quartet
80470 Rococo (Rendez-vous—intermezzo) (Aletter), Armand Vecsey and his Hungarian Orchestra
Serenade in B Flat Minor (Rachmaninoff), Armand Vecsey and his Hungarian Orchestra
80471 St. John, 14:1-3, 25-27, and The Precious Name (Loane) Scripture lesson with hymn, Rev. William H. Morgan, D.D., and Calvary Choir
Twenty-third Psalm, and He Leadeth Me, Bradbury) Scripture lesson with hymn, Rev. William H. Morgan, D.D., and Calvary Choir
5050 Ev'rybody Calls Me Honey (Straight) Contralto, Helen Clark
Waltz Alabam' (A Darky Waltz Dream) (Barth) Tenor. George Wilton Ballard and Chorus
50541 Jazz de Luxe—Fox-trot (Fuller), Earl Rutter's Famous Jazz Band
Sensation Jazz One-step (Dixieland Jazz Band) Saxophone, Xylophone and Piano, for dancing. All Star Trio
50542 Nigger Blues (White). Al Bernard
Satan, I'm Here (I Couldn't Stand for a Triffin' Man) (Walker). Ernest Hare
50544 Djer-Kiss Waltz (Ager) for Dancing, Jaudus' Society Orchestra
Egyptland—Fox-trot (Casey) for Dancing, Green Bros. Novelty Orchestra
50547 Boy and the Birds (Characteristic) (Hager), New York Military Band
Sliding Sid (Losch). New York Military Band

EDISON AMBEROL RECORDS

- SPECIALS
3782 Turkestan (Stern) Male Voices. Premier Quartet
3783 Frenchy, Come to Yankee-Land (Ehrlich-Conrad). Tenor. Billy Murray and Male Chorus
3785 Tears—Fox-trot (Henry). Tuxedo Dance Orchestra
3787 Jazzola (Robinson-Morse) Male Voices, Premier Quartet
3788 Call of the Cosy Little Home—Take It From Me (Johnstone) Soprano and Tenor, Leola Lucey and Charles Hart
3790 Everybody Wants a Key to My Cellar (Rose-Baskett-Pollack). Al Bernard
3791 You're Still an Old Sweetheart of Mine (Whiting) Mixed Voices. Metropolitan Quartet
3796 Don't Forget the Salvation Army (My Doughnut Girl) (Brown-Frisch) Baritone, Arthur Fields and Male Chorus
3798 I'm Forever Blowing Bubbles (Kenbrovin-Kellette) Contralto and Tenor, Helen Clark and George Wilton Ballard
3800 Don't Cry, Frenchy, Don't Cry (Donaldson) Tenor. George Wilton Ballard
3801 Heart-Breaking Baby Doll (Hess-Mitchell), Arthur Fields
ROYAL PURPLE RECORDS
29032 Funiculi-Funicula (Denza) Tenor, Guido Ciccolin and Chorus of Girls
29033 Carmena—Vocal Waltz (Wilson) Soprano, Alice Verlet
REGULAR LIST
3781 Dear Little Boy of Mine (Ball) Counter-Tenor, Will Oakland
3784 Beale Street Blues (Handy). Al Bernard
3786 Forget-Me-Not (Kendis-Brockman) Tenor, Manuel Romain
3789 B-Hap-e—One-step (Be Happy) (Lada-Nunez-Burger) for Dancing. Louisiana Five
3792 Razzle-Dazzle—One-step (Lenzberg) for Dancing. Lenzberg's Riverside Orchestra
3793 Hezekiah Hopkins "Comes to Town" (Boone) Descriptive Talk. Len Spences
3794 Lord's Prayer, Doxology, Responses and Hymn, Rev. William H. Morgan, D.D., and Calvary Choir
3795 I Ain't Got'en No Time to Have the Blues (H. Von Tilzer). Billy Murray and Ed. Smalle
3797 World Is Hungry for a Little Bit of Love (Even You and I) (Turner) Tenor, Vernon Dalhart
3799 Tiger Rose Waltzes (Reid-de Dose) for Dancing. Lenzberg's Riverside Orchestra

PATHE FRERES PHONOGRAPH CO.

POPULAR SUPPLEMENT NO. 23 VOCAL RECORDS

- 22144 Ballyho Bay. Patricola
Take Your Girlie to the Movies. Patricola
22142 The First Rose of Summer, from "She's a Good Fellow". Sam Ash
I'm Forever Blowing Bubbles, Lewis James and Charles Hart
22125 Oh, Lady, Stop Rolling Your Eyes! Arthur Fields
Turkestan. Premier American Quartet
22124 I Ain't Got'en No Time to Have the Blues, Billy Murray and Ed. Smalle
Oh, How She Can Sing! Billy Murray and Ed. Smalle
22143 You're Making a Miser of Me. Henry Burr
Roses at Twilight. James and Hart
22127 Good-bye, Wild Women, Good-bye! Arthur Fields
Katydid Is the Candy Kid. Byron G. Harlan
22126 Friends. Henry Burr
The Gates of Gladness. Acme Male Quartet
22111 Himilaya. Premier American Quartet
Daa, Dee, Dum! Arthur Fields
22128 Anything Is Nice If It Comes from Dixieland, Premier American Quartet
When I Met You. Sam Ash
FASCINATING HAWAIIAN NOVELTIES
22130 Honolulu, "March". Toots Paka Hawaiian Troupe
Kawaihau, "Waltz". Toots Paka Hawaiian Troupe
DANCE RECORDS
Waldorf-Astoria Dance Orchestra, under Direction of Joseph Knecht
22137 Tell Me. Fox-trot.
Western Land. One-step.
22138 The Red Lantern. Medley fox-trot.
Ruspana. One-step.
22139 My Dreamy Little Lotus Flower. Fox-trot.
Down by the Meadow Brook. Waltz.
22146 Dixie Is Dixie Once More. One-step.
That's Got 'Em. Fox-trot.
22147 Missouri Blues. Fox-trot.
My Chocolate Soldier Sammy Boy. One-step.
Green Brothers' Xylophone Orchestra
22119 Bells of Bagdad. Fox-trot.
Mary Ann. One-step.
VIOLIN AND PIANO DANCE RECORDS
22140 The Music of the Wedding Chimes. Medley fox-trot.
T-h-a-n-k Y-o-u! (Merci Beaucoup). Medley fox-trot.
THE "JAZZ" NOVELTIES OF THE YEAR
Jim Europe's Famous "Hell Fighters" Band
BAND RECORDS
22080 How Ya Gonna Keep 'Em Down on the Farm? Chorus by Lieut. Noble Sissle. One-step.
Arabian Nights. One-step.
22081 Darktown Strutters' Ball. Medley fox-trot.
Indianola. Fox-trot.
22082 Broadway "Hit" Medley. Fox-trot.
Ja-Da. Fox-trot.
22085 That Moaning Trombone. One-step.
Memphis Blues. Fox-trot.
22087 Russian Rag. Fox-trot.
St. Louis Blues. Fox-trot.
22086 Plantation Echoes. Vocal chorus by Singing Serenaders.
Hesitating Blues. Fox-trot.
VOCAL RECORDS
(All accompaniments played by Europe's "Hell Fighters" Band)
22089 Mirandy. Tenor. Lieut. Noble Sissle
On Patrol in No Man's Land. Tenor, Lieut. Noble Sissle
22103 Jazz Baby. Baritone. Creighton Thompson
When the Bees Make Honey. Lieut. Noble Sissle
22104 All of No Man's Land Is Ours. Tenor, Lieut. Noble Sissle
Jazzola. Tenor. Lieut. Noble Sissle
22084 Little David Play on Your Harp (Negro Spiritual), Lt. Sissle and Lt. Europe's Serenaders
Exhortation (Jubilee Song) Creighton Thompson and Lt. Jim Europe's Singing Serenaders
22105 Roll, Jordan, Roll, Lieut. Jim Europe's Singing Serenaders
Everybody Dat Talks About Heaven Ain't Goin' There. Lieut. Europe's Singing Serenaders

PATHE FRERES PHONOGRAPH CO.

REGULAR AUGUST LIST

- OPERATIC AND STANDARD VOCAL RECORDS
34030 Manon (Massenet) "Gavotte," in French. Soprano. Claudia Muzio
27510 Absent (Metcalf). Contralto. Kathleen Howard
My Son! (Carrie Jacobs-Bond). Contralto, Kathleen Howard
25031 The Banks of Allan Water (Horn). Tenor, Craig Campbell
I Know a Lovely Garden (D'Hardelot). Tenor. Craig Campbell
STANDARD BALLADS SUNG IN ENGLISH
40167 Home, Sweet Home (Payne-Bishop). Contralto, Helen Clark
Darby and Joan (Molloy). Contralto, Helen Clark
40164 Love's Sorrow (Shelley). Tenor. Lewis James
In the Garden of My Heart (Ball). Tenor, Lewis James
NEW SACRED SOLOS
52042 How Lovely Are Thy Dwellings (Liddle). Baritone. Percy Hemus
Crossing the Bar (Willeby). Baritone, Percy Hemus
22106 A Clean Heart (Byshe). Tenor, organ accomp., Earle F. Wilde
Flee As a Bird (Dana). Tenor, organ accomp., Earle F. Wilde
NEW INSTRUMENTAL NOVELTIES
40169 Menuet (Beethoven). Violins, viola and cello. The Great Lakes String Quartet
To a Wild Rose (MacDowell). Violins, viola and cello. The Great Lakes String Quartet
59075 Gavotte (Leschetizky). Piano solo, Mme. Ethel Leginska
Rhapsody, No. 13 (Liszt). Piano solo, Mme. Ethel Leginska
40165 Melodie (Tschaikowsky). Violin solo, Jan Rudenyi
Canzonette (D'Ambrosio). Violin solo, piano accomp., Jan Rudenyi
22107 The Adieu (Schubert). Cornet solo, Sergeant Leggett
Serenade (Gounod) "Quand tu chantes." Cornet solo. Sergeant Leggett
NEW BAND AND ORCHESTRA RECORDS
40166 Déjanire (Saint-Saëns) "Choeur danse." Garde Republicaine Band of France
Regiment of the Braves (Borrel) March, Garde Republicaine Band of France
22108 The Thunderer (Sousa) March, American Regimental Band
(Continued on page 172)

RECORD BULLETINS FOR AUGUST—(Continued from page 171)

- The Loyal Legion (Sousa) March, American Regimental Band 10
- 40168 Fauns and Woodnymphs (Danse Pastorale) (Onivas) Pathe Concert Orchestra 12
- Poppies (A Japanese Romance) (Moré) Pathe Concert Orchestra 12
- 22118 Wild Honey (David), Toots Paka Hawaiian Troupe 10
- Till We Meet Again (Whiting), Toots Paka Hawaiian Troupe 10

GENNETT LATERAL RECORDS

- 9001 Annie Laurie (Scott). Male quartet, unaccompanied. Criterion Quartet
- Home, Sweet Home (Payne-Bishop). Male quartet, unaccompanied. Criterion Quartet
- 4534 The Two Doctors (Golden and Hughes) My Uncle's Farm. Golden and Hughes
- 4535 Friends Medley (Santly-Johnson-Meyer). Fox-trot. Green Brothers' Xylophone Orchestra
- Fluffy Ruffles (Green). One-step. Green Brothers' Xylophone Orchestra
- 4536 I Know What It Means to Be Lonesome (Kendis-Brockman-Vincent). Tenor, orch. accomp., John Connell
- You're Making a Miser of Me (Dubin-Ball). Tenor, orch. accomp. Henry Burr
- 4537 The Boy and the Birds (Hager). Orch. accomp., Sibyl Sanderson Fagan
- The Little Whistler (Ring-Hager). Orch. accomp., Sibyl Sanderson Fagan
- 2500 My Cairo Love. Green Brothers' Xylophone Orchestra
- Mammy O' Mine. Medley. For dancing, with singing chorus. Green Brothers' Xylophone Orchestra

OKEH RECORDS

- 1193 Who Played Poker With Pocahontas? (Lewis-Young-Ahlert). Contralto, with orchestra. (From "Monte Cristo, Jr.") Star of the Winter Garden Show, New York. Fannie Watson
- For Johnny and Me (Brown-Von Tilzer). Contralto, with orchestra. Star of the Winter Garden Show, New York. Kitty Watson
- 1194 When You See Another Sweetie Hanging Around (Lewis-Young-Donaldson). Contralto, with orchestra. Kitty Watson
- Everybody Wants a Key to My Cellar (Rose-Baskette-Pollack). Contralto, with orchestra. Fannie Watson
- 1195 The Red Lantern (Shine Red Lantern) (Fisher). Baritone, with orchestra. Joe Phillips
- I'm Forever Blowing Bubbles (Kenbrovin and Kellelte). Tenor duet, with orchestra. Campbell and Burr
- 1196 Sweet Siamese (Mary Earl). Fox-trot, xylophone orchestra. Green Brothers
- Ruspana (Mary Earl). One-step. xylophone orchestra. Green Brothers
- 1197 Mammy O' Mine (Tracey-Pinkard). Vocal trio, with orchestra. Sterling Trio
- I Found You (Gilbert-Friedland). Tenor, with orchestra. Henry Burr
- 1198 Beautiful Ohio (MacDonald-Earl). Vocal duet, with orchestra. Ruth Lenox and Henry Burr
- Tears (Of Love) (Warren-Henry). Tenor, with orchestra. Henry Burr
- 1199 Chong (He Come from Hong Kong) (Weeks). Fox-trot, instrumental. Van Eps Quartet
- Singapore (Intro. "Wild Honey") (Gilbert-Friedland). Fox-trot, xylophone orchestra. Green Brothers
- 1200 After All (Callahan and Roberts). Fox-trot, instrumental. Louisiana Five Jazz Orchestra
- (Dry Your) Tears (Hickman-Black). Fox-trot, xylophone orchestra. Green Brothers
- 1201 You're Still An Old Sweetheart of Mine (Egan-Whiting). Vocal duet, with orchestra. Burr and Meyers
- When You Look in the Heart of a Rose (Gillespie-Methven). Tenor, with orchestra. Sam Ash
- 1202 Wait and See (You'll Want Me Back) (McCarron Morgan). Tenor, with orchestra. Irving Kaufman
- 1202 Heart-Breaking Baby Doll (Hess-Mitchell). Tenor, with orchestra. Billy Murray
- 1203 That Long, Long Trail Is Getting Shorter Now (Mahoney). Vocal trio, with orchestra. Sterling Trio
- Salvation Lassie of Mine (Caddigan-Story). Tenor, with orchestra. Henry Burr
- 1205 Turkestan (Jones-Stern). Vocal quartet, with orchestra. Premier-American Quartet
- Burmah Moon (Gitz-Rice). Tenor, with orchestra. Sam Ash
- 1206 Eyes That Say "I Love You" (Fisher). Tenor, with orchestra. Billy Murray
- Chong (He Come from Hong Kong) (Weeks). Tenor, with orchestra. Irving Kaufman

EMERSON PHONOGRAPH CO.

NEW GOLD SEAL RECORDS
BIG POPULAR SONG HITS

- 9195 Himalaya—A Song of the Far East (Warren-Henry-Onivas). Baritone solo, orch. accomp., Billy Murray 9
- Oh, How She Can Sing (Yellen-Van-Schenck). Character song, orch. accomp., Billy Murray and Eddie Smalle 9
- 9196 My Dreamy Little Lotus Flower (Glick-Olman). Tenor solo, orch. accomp., Henry Burr 9
- Kiss Me Again (Blossom-Herbert). Soprano solo, orch. accomp., Laura Combs 9
- 9203 Take Me to the Land of Jazz (Kalmar-Leslie-Wendling). Jazz melody, orch. accomp., Irving and Jack Kaufman 9
- Take Your Girlie to the Movies—If You Can't Make Love at Home (Leslie-Kalmar-Wendling). Character song, orch. accomp., Irving Kaufman 9
- 9198 Blues My Naughty Sweetie Gives to Me (Swanstone-McCarron-Morgan). Character Song, orch. accomp., Irving Kaufman 9
- I Ain't Got-en No Time to Have the Blues (Harry Von Tilzer). "Blues" character song, orch. accomp., Irving and Jack Kaufman 9
- 9202 The Gates of Gladness. On the Road to Sunshine Land (Brennan-Cunningham-Rule). Tenor and haritone duet, orch. accomp., Charles Hart and Elliot Shaw 9
- Longing (Seymour-Pike). Tenor solo, orch. accomp., Henry Burr 9
- 9200 Our Yesterdays (Lake-Leslie). Tenor solo, orch. accomp., Henry Burr 9
- Sometime It Will Be Love Time, Sometime—Somewhere (Walker-Arthur). Tenor solo, piano and violin accomp., Edward Hamilton 9

- 9205 Oh You Women! (Stept-Green). Character song, orch. accomp., The Three Kaufelds 9
- Ze Yankee Boys Have Made a Wild Frenchy Baby Out of Me (West-Gold). Character song, orch. accomp., Arthur Fields 9
- 9199 Some Sunny Day (Jackson-Donaldson). Tenor solo, orch. accomp., Sam Ash 9
- When I Met You (Armstrong-Klickmann). Tenor and haritone duet, orch. accomp., Burr and Myers 9
- 9197 You're Making a Miser of Me (Dubin-Ball). Tenor solo, orch. accomp., Sam Ash 9
- My Little Sunshine (Jones-Conrad). Male trio, orch. accomp., Sterling Trio 9
- 9204 Evening, Brings Love Dreams of You (Burt-nett-Gillespie). Tenor solo, piano and violin accomp., Edward Hamilton 9
- When I'm Gone You'll Soon Forget (E. Austin Keith). Male quartet. Peerless Quartet 9
- LATEST DANCE HITS
- 1025 The Alcoholic Blues. Some Blues (Al. Von Tilzer). Fox-trot. Emerson Military Band
- Western Land (B. ron Gay). Fox-trot. Emerson Military Band 10
- 1024 Dafiodil Waltz (Gerald Arthur). Waltz. Emerson Nylo-Phiends 10
- The Bells of Bagdad (Otto Motzan). Fox-trot. Emerson Nylo-Phiends 10
- 1023 You're the One That I Want (Hugo Frey). One-step, hanjo, piano and saxophone, Van Eps Banta Trio 10
- Chong. Medley. Intro. "Anything Is Nice If It Comes from Dixieland" (Weeks-Clarke-Ager-Meyer). Fox-trot, hanjo, piano and saxophone, Van Eps Banta Trio 10
- 9201 Gypsy Girl (Oliver Wallace). Fox-trot. Emerson Nylo-Phiends 9
- Little Italy (David-Hewitt). Fox-trot. Emerson Military Band 9
- 1026 Dixie Blues (Lada-Nunez-Cawley). "Blues." Fox-trot. Louisiana Five 10
- Thunderbolt (Lada Nunez-Cawley). One-step, Louisiana five 10

STANDARD AND NOVELTY SELECTIONS

- 1027 Irish Jigs. Accordion duet, Phil and Dan Boudini 10
- Irish Reels. Accordion duet, Phil and Dan Boudini 10
- 1028 Lights Out (E. E. McCoy). March, Bergh's Concert Band 10
- American Patrol (F. W. Meacham). March, Bergh's Concert Band 10
- 1029 A Nightingale (Fred W. Hager). Descriptive novelty, bird voices, orch. accomp., Sibyl Sanderson Fagan 10
- My Sweet Song Bird of the California Hills (Ring-Hager). Descriptive whistling novelty, orch. accomp., Sibyl Sanderson Fagan and Henry Burr 10
- 1030 Daddy (Lemon-Behrend). Contralto solo, piano and violin accomp., Elizabeth Lennox 10
- Long Ago in Alcaia (Weather, Ross-Messenger). Baritone solo, orch. accomp., Royal Dalmun 10

EMERSON PHONOGRAPH CO.

THE NEW SEVEN-INCH RECORDS
BIG POPULAR SONG HITS

- 7508 Don't Forget the Salvation Army (Leffingwell-Lucas-Brown-Frisch). Baritone solo, orch. accomp., D. (Bud) Bernie 7508
- Oh You Women (Green-Stept). Character song, orch. accomp., The Emersonian Three 7509
- Himalaya—A Song of the Far East (Warren-Henry-Onivas). Baritone solo, orch. accomp., Jack Tracey
- When I Met You (Armstrong-Klickman). Tenor and baritone duet, orch. accomp., Rice and Wilbur
- 7510 Friends (Johnson-Santly-Meyer). Baritone solo, orch. accomp., D. (Bud) Bernie
- 7508 Oh You Women (Green-Stept). Character song, orch. accomp., The Emersonian Three
- 7509 Himalaya—A Song of the Far East (Warren-Henry-Onivas). Baritone solo, orch. accomp., Jack Tracey
- When I Met You (Armstrong-Klickman). Tenor and baritone duet, orch. accomp., Rice and Wilbur
- 7510 Friends (Johnson-Santly-Meyer). Baritone solo, orch. accomp., D. (Bud) Bernie
- When I'm Gone You'll Soon Forget (E. Austin Keith). Male quartet. Peerless Quartet 7511
- Blues My Naughty Sweetie Gives to Me (Swanstone-McCarron-Morgan). "Blues" character song, orch. accomp., George Beaver
- After All That You've Done to Me (Coslow-Platzman). Tenor solo, orch. accomp., George Gordon
- 7512 When the Bees Make Honey Down in Sunny Alaham' (Lewis-Young-Donaldson). Baritone duet, orch. accomp., Sanford and Sanford
- My Dreamy Little Lotus Flower (Glick-Olman). Tenor solo, orch. accomp., Robert Rice
- 7513 Lullaby Blues. In the Evening (Kendall-Robinson-Morse). Male quartet, orch. accomp., Emerson Quartet
- I Ain't Got-en No Time to Have the Blues (Harry Von Tilzer). Character duet, orch. accomp., Sanford and Sanford
- 7514 Oh Lawdy! Something's Done Got Between Ebecanzeer and Me (Creamer-Layton). "Blues" character song, orch. accomp., Jack Tracey
- Oh! How She Can Sing (Yellen-Van-Schenck). Character duet, orch. accomp., Jack Tracey and Eddie Smalle
- 7515 Burmah Moon (Lieut. Gitz-Rice). Tenor solo, orch. accomp., William Sloane
- Our Yesterdays (Lake-Leslie). Tenor solo, orch. accomp., Robert Rice
- DANCE AND BAND HITS
- 7516 Mammy's Lullaby (Lee S. Roberts). Waltz, Emerson Military Band
- Sweet Hawaiian Moonlight (F. Henri Klickman). Waltz. Emerson Military Band
- 7517 The Vamp (Byron Gay). Fox-trot with words, Emerson Dance Orchestra
- Church Street Sobbin' Blues (Lada-Nunez-Cawley). "Blues" fox-trot. Frisco Five
- 7518 Wild Honey (Lee David). Fox-trot, Emerson Xylo-Phiends
- My Cairo Love (An Egyptian Serenade) (J. S. Zamecnik). Fox-trot. Emerson Xylo-Phiends
- 7519 Yama Yama Blues (S. and C. Williams). Fox-trot, Frisco Five
- Rainy Day Blues (F. Warshauer). Fox-trot, Frisco Five

EMPIRE TALKING MACHINE CO.

POPULAR SONGS

- 21113 Eyes That Say I Love You (Fisher). Orch. accomp., Empire Male Quartet
- When I Met You (Armstrong-Klickman). Tenor solo, orch. accomp., Sam Ash
- 21114 Friends (Meyer-Santley). Tenor solo, orch. accomp., Henry Burr
- Daa, Dee Dum (Vincent-Flatow). Baritone solo, orch. accomp., Arthur Fields
- 21115 Roses at Twilight (Black-Marple). Male duet, orch. accomp., Lewis James and Chas. Hart
- Gates of Gladness (Brennan-Cunningham-Rule). Orch. accomp., Empire Male Quartet

"The Music Without the Blur!"

This ideal of talking machine manufacture is attained more nearly than by any other, in the construction of the

MARVELOUS MAGNOLA
"Built by Tone Specialists"

"Magnola's Tone Deflector eliminates the scratch"



Watching the Music Come Out

We want to show you how to make money with MAGNOLA; and how MAGNOLA is the best buy on the Talking Machine Market to-day.

Send us your name and let us send you some real Talker Tips.

MAGNOLA TALKING MACHINE COMPANY

OTTO SCHULZ, President

General Offices Southern Wholesale Branch
711 MILWAUKEE AVENUE 1530 CANDLER BLDG.
CHICAGO ATLANTA, GA.

- 21110 On the Ozark Trail (Skidmore and Walker). Orch. accomp., Collins and Harlan
- Good-bye, Wild Women, Good-bye (Johnson-Ager-Meyer). Baritone solo, orch. accomp., Arthur Fields
- DANCE SELECTIONS
- 21110 The Alcoholic Blues (Von Tilzer). Fox-trot, Empire Jazz Band
- At the Jazz Band Ball (La Rocca and Shields). One-step. Empire Jazz Band
- 31111 Western Land (Gay). One-step, Empire Dance Orchestra
- My Dreamy Little Lotus Flower (Glick-Olman). Fox-trot. Empire Dance Orchestra
- 31112 Ruspana (Earl). One-step. Empire Dance Orchestra
- Contentment (Penn). Waltz. Empire Dance Band
- STANDARD VOCAL SELECTIONS
- 41104 Jesus, Lover of My Soul (Marsh). Tenor solo, organ accomp., Stanley Mackey
- The Sweet Story of Old (Engelbreth). Tenor solo, organ accomp., John Manning
- INSTRUMENTAL SELECTIONS
- 51110 The Irish Regiment (DeWitt). Empire Military Band
- General Pershing March (Vandersloot), Empire Military Band
- 51111 The Whistler and His Dog (Pryor), Empire Concert Band
- The Village Band (Gavnt). Empire Concert Band
- 51113 Will You Remember (Johnson-Young-Sigmund). Violin solo, piano accomp., Alice Raymond
- Spring Song (Mendelssohn). Violin solo, piano accomp., Albert Faber
- HAWAIIAN SELECTIONS
- 61104 Christmas Waltz (Margis), Louise and Ferera Hawaiian Orchestra
- La Paloma (Hradier), Louise and Ferera Hawaiian Orchestra

NO VICTOR RECORDS FOR AUGUST

Victor Co. to Take Advantage of Opportunity Thus Presented to Take Care of Volume of Unfilled Record Orders Now on the Books.

In order to catch up to some extent at least with the large number of unfilled orders for records that have been accumulating for some months past, the Victor Talking Machine Co. has announced to its wholesale jobbers and dealers that no new record supplement will be issued for August, but that the efforts that would ordinarily be devoted to the producing of new records will be used for pressing records to fill orders now on hand. The official announcement of the company says in part:

"To furnish you with records you have had on order for some months past, we have been compelled to take extraordinary measures, and have decided to list no new records for August, 1919. Instead we shall devote all our energies for one month to the manufacture of records for which the trade has a large unfilled demand.

"We shall, however, issue a supplement in which we have listed a greater number of records than usual, and in greater variety. The records so listed are all excellent selections and, better still, they are records of which there are some stocks available in the hands of our distributors."

Some Leading Jobbers of Talking Machines in America

1856 **WURLITZER** 1916

VICTOR
DISTRIBUTORS
VICTORS EXCLUSIVELY

We make a specialty of getting the order out on time—every time.

The Rudolph Wurlitzer Co.
CINCINNATI AND CHICAGO

Two points of supply; order from the nearer

TEST IT. 

OUR VICTOR

Record Service

has a reputation for efficiency.
Suppose you try it.

E. F. DROOP & SONS CO.
1300 G. STREET, WASHINGTON, D. C.
231 N. HOWARD STREET, BALTIMORE, MD.



W. J. DYER & BRO.
DYER B'LD'G, ST. PAUL, MINN.
NORTHWESTERN DISTRIBUTORS
OF THE

 **VICTOR**
Machines, Records and Supplies

Shipped Promptly to all
Points in the Northwest



Where Dealers May Secure

COLUMBIA

Product

Ready, Full Stocks, and Prompt Deliveries
from Convenient Shipping Centers
all over the United States.

Distributors

Atlanta, Ga., Columbia Graphophone Co., 63 N. Pryor St.
Baltimore, Md., Columbia Graphophone Co., 16 South Howard St.
Boston, Columbia Graphophone Co., 137 Federal St.
Buffalo, N. Y., Columbia Graphophone Co., 736 Main St.
Chicago, Ill., Columbia Graphophone Co., 14 N. Michigan Ave.
Cincinnati, O., Columbia Graphophone Co., 427-429 W. Fourth Ave.
Cleveland, O., Columbia Graphophone Co., 1375 Euclid Ave.
Dallas, Tex., Columbia Graphophone Co., 1011 Elm St.
Denver, Colo., Columbia Stores Co., 1608 Glenarm Place.
Detroit, Mich., Columbia Graphophone Co., 401 Woodward Ave.
Indianapolis, Ind., Columbia Graphophone Co., 207-217 W. Washington St.
Kansas City, Mo., Columbia Graphophone Co., 1017 McGee St.
Los Angeles, Cal., Columbia Graphophone Co., 745 S. Broadway.
Minneapolis, Minn., Columbia Graphophone Co., 412-414 Nicollet Ave.
New Haven, Conn., Columbia Graphophone Co., 206 Meadow St.
New Orleans, La., Columbia Graphophone Co., 517-525 Canal St.
New York City, Columbia Graphophone Co., 55 Warren St.
Omaha, Neb., Schmoller & Mueller Piano Co., 1311 Farnum St.
Philadelphia, Pa., Columbia Graphophone Co., 210 N. Broad St.
Pittsburgh, Columbia Graphophone Co., 632-640 Duquesne Way.
Portland, Me., Columbia Graphophone Co., 43 Exchange St.
Salt Lake City, Utah, Columbia Stores Co., 221 South West Temple.
San Francisco, Cal., Columbia Graphophone Co., 130-150 Sutter St.
Seattle, Wash., Columbia Graphophone Co., 911 Western Ave.
Spokane, Wash., Columbia Stores Co., 161 South St.
St. Louis, Mo., Columbia Graphophone Co., 1127 Pine St.
Tampa, Fla., Tampa Hardware Co.

Headquarters for Canada:
Columbia Graphophone Co., 54-56 Wellington St., West, Toronto, Ont.

Executive Office
COLUMBIA GRAPHOPHONE CO.
Woolworth Building New York

STARR Phonographs and GENNETT Records
Complete Stock and REAL Service

Crafts-Starr
PHONOGRAPH CO.

Factory Distributors
218-220 NORTH SECOND STREET, RICHMOND, VIRGINIA
Write for Dealers' Proposition'

Mickel Bros. Co.

Omaha, Nebraska
Des Moines, Iowa

Victor Distributors

William Volker & Co., Kansas City, Mo.; Houston, Tex., and Denver, Col.

Pathe 

DISTRIBUTORS
Complete Pathephone and Pathe Record Stocks.
The best proposition for the progressive dealer.

Sherman, Clay & Co.

San Francisco, Los Angeles, Portland, Seattle, Spokane
PACIFIC COAST DISTRIBUTORS OF
VICTOR PRODUCTS

Southern Victor Dealers
Largest Stock VICTROLAS and RECORDS.
Prompt Shipment and Low Freight Rates.

WALTER D. MOSES & CO.
Oldest Music House in Virginia or North Carolina.
RICHMOND, VA.

The PERRY B. WHITSIT CO.
Distributors of
Victrolas and Victor Records
COLUMBUS, OHIO

OLIVER DITSON COMPANY
Largest VICTOR Talking Machine Distributors East of Chicago.
Creators of "The Fastest Victor Service." Let us tell you more about our service.

BOSTON

Have You Noted the Growth of This Department?
Special Rates for Jobbers' Directory on Application

During the past six months this Jobbers' Directory has grown steadily in importance. It affords progressive jobbers an opportunity to keep their names before the dealers consistently and regularly, and provides representation in the Jobbers' Directory of the publication which is the recognized authority of the industry.

Join the progressive jobbers on this page next month.

Pathe 

"The Quality Phonograph"
PLAYS ALL MAKES OF RECORDS
Dealers in southeastern territory write for full information. Our representative will be pleased to call without any obligation to you.
THE JOHN A. FUTCH COMPANY, Distributors
Jacksonville, Florida

Victor Exclusively
EASTERN TALKING MACHINE CO.
177 Tremont Street, Boston
VICTOR DISTRIBUTORS

Index of Advertisers

A		Grand Rapids Phonograph Co.	28	Parr Mfg. Corp.	138
Acme Die Casting Corp.	140	Gray, Walter S.	144	Pathé Frères Phonograph Co.	54, 55
Acme Phonograph Corp.	89, 128	Great Eastern Mfrs. Co.	159	Pearsall Co., Silas E.	9
Aeolian Co.	152	Gretsch Mfg. Co., Freil.	116	Peckham Mfg. Co.	96
Aldine Co.	123	Grey Gull Records.	88	Peerless Album Co.	133
American Recording Laboratories.	142, 163	Griffith Piano Co.	31	Penn Phonograph Co.	51
American Talking Machine Co.	134	Grinnell Bros.	79	Perfect Automatic Brake Co.	106
Andrews, W. D. & C. N.	82	H		Phoenix Phonograph Co.	110
Ansonia Needle Co.	160	Handy Mfg. Co.	107	Phonograph Appliance Co.	156
Atlas Sales Corp.	139	Harper Bros.	153	Phonograph Supply Co. of New England.	64
Automatic Cover Support & Mfg. Co.	122	Harponola Co.	158	Phonomotor Company	46
B		Heineman Phonograph Supply Co.		Plywood Corporation	68
B. & H. Fibre Mfg. Co.	36	Inserts facing pages 18, 34, 82, 98		Precision Castings Co.	19
Badger Talking Machine Co.	119	Hessig-Ellis Drug Co.	30	Progressive Phonograph Supply Co.	129
Bagshaw Co., W. H.	62	Hiawatha Phonograph Co.	108	R	
Barnhardt Bros. & Spindler.	6, 58	Hillman & Son Phonograph Co.	31	Ramos-Eubank Phonograph Mfg. Co.	144
Beecroft, Clement	87	Hough, J. E., Ltd.	166	Recordeon Phonograph Co.	118
Belcanto Co., Inc.	57	I		Record Needle & Mfg. Co.	33
Blackman Talking Machine Co.	157	Isley-Doubleday & Co.	161	Regina Co.	156
Bliss Reproducer, Inc.	13	Indiana Die Casting Co.	34	Reid Lawson, Inc.	148
Boston Book Co., Inc.	43	International Mica Co.	68	Rene Manufacturing Co., The.	143
Brilliantone Steel Needle Co.	17	Invicta Record Co., Ltd.	167	Rex Gramophone Co.	168
British Polyphon Co.	168	J		Rishel Phonograph Co.	92
Brooks Mfg. Co.	46	Jaquith Machinery Bureau, Inc.	64	Rountree Corporation	31
Bruno, C. & Son, Inc.	91	Jewel Phonoparts Co.	107	S	
Brunswick-Balke-Colender Co.	Insert following page	Jones-Motrola, Inc.	124	Schloss Bros.	98
Buegeleisen & Jacobson.	151	K		Schwab, W.	138
Buehn Co., Louis.	52	Kaumanns & Co.	109	Schwartz-Herrmann Steel Works, Inc.,	
Bush & Lane Piano Co.	119	Kent Co., F. C.	127	Insert following page	
C		Keystone Minerals Co.	164	Seeburg, J. P., Piano Co.	29
Cabinet & Accessories Sales Co.	123	Kiefer-Stewart Co.	30	Shelton Electric Co.	90
Charmaphone Co.	47	Kirkman Engineering Corp.	99	Sherman, Clay & Co.	173
Cheney Phonograph Co.	60	Knickerbocker Talking Machine Co.	83	Singer Talking Machine Co.	121
Chicago Hinged Cover-Support & Balance Co.	109	Kraft, Bates & Spencer, Inc.	63	Smith Drug Co., C. D.	30
Chicago Recording Scale Co.	115	Krasberg Engineering & Manufacturing Corp.	23	Smith, Kline & French Co.	31
Chicago Talking Machine Co.	84	L		Smith Laboratories, H. J.	124
Classified (Want) Ads.	162-163	Lakeside Supply Co., Inc.	111	Smith-Schiffelin Co.	58
Cliff Manufacturing Works, Inc.	146	Language Phone Method.	67	Sona-Tone Phonograph, Inc.	145
Cole & Dumas Music Co.	89, 98, 112, 121	Lansing, E. H.	64	Sonora Phonograph Sales Co., Inc.	Inside Cover
Coleman Mercantile Co.	134	Latrobe Die & Casting Co.	156		30, 31, 65
Columbia Graphophone Co.	14, 15, 18, 26, 32, 50, 57, 67, 87, 112, 122, 127, 137, 145, 173	Lawson Piano Co.	134	Soss Manufacturing Co.	146
Compton-Price Co.	Insert following page	Lesley's	170	Sound Recording Co., Ltd.	166
Condon & Co., Inc.	25	Liberty Phonograph Co.	10	Southern Drug Co.	30
Consolidated Talking Machine Co.	106	Long Cabinet Co., Geo.	80	Southern Sonora Phonograph Co.	31
Copper Process Co.	95	Lorentzen, H. K.	96	Southwestern Drug Co.	30
Corley Co.	75	Lucky 13 Phonograph Co.	27, 89, 126, 163	Standard Talking Machine Co.	173
Cortina Academy	29	Lundstrom Mfg. Co., C. J.	78	Starr Piano Co.	130
Crafts-Starr Phonograph Co.	173	Lu-Franc Sales Service Co.	116	Steger & Sons.	100
Craies & Stavridi.	167	Lyon & Healy.	102	Stein-Burn Corp.	Insert following page
Cressey & Allen.	133	Lyons, J. L.	106	Steinert, M., & Sons, Co.	62
Culp Phonograph Co.	160	M		Stephenson, Inc.	Insert following page
Curry, Frank B.	64	Magnola Talking Machine Co.	26, 98, 103, 160, 172	Sterling Devices Co.	115
D		Mandel Mfg. Co., Inc.	Insert following page	Stern, Jos. W., & Co.	141
Ditson Co., Oliver.	76, 173	Manhattan Phonograph Co.	158	Sterno Manufacturing Co.	150
Dodin, Andrew H.	146	Manufacturers Sales Co.	123	Strevell-Paterson Hardware Co.	30
Doehler Die-Casting Co.	97	Marshall & Co., C. L.	31	T	
Droop & Sons Co., E. F.	173	Master Wax Co.	153	Talking Book Corp.	147
Duo Tone Co.	91	Mellor's	122	Talking Machine World Dealer Service.	125
Dyer & Bro., W. J.	173	Mernod & Co.	140	Thomas Mfg. Co.	135
E		Meyercord Co.	104	Tyrolia Talking Machine Co.	66
Eastern Talking Machine Co.	61, 173	Michigan Phonograph Co.	136	U	
Eclipse Musical Co.	137	Mickel Bros. Co.	70, 173	Udell Works	121
Edison Inc., Thos. A.	Back Cover, 40, 132	Milwaukee Talking Machine Mfg. Co.	117	Unit Construction Co.	20
Elyea Company	77	Minneapolis Drug Co.	30	Universal Stamping & Mfg. Co.	105
Emerson International, Inc.	24	Moderhola Co.	69	Usona Talking Machine Co.	113
Emerson New England, Inc.	63	Montagues, J., & Co.	31	V	
Emerson Philadelphia Co.	53	Moses & Co., Walter D.	173	Van Houten, C. J., & Zoon.	30
Emerson Phonograph Co.	48	Musante, Joseph	19	Van Veen & Co., Arthur L.	99
Emerson Record Sales Co.	16	Musik Trade Review.	154	Veeco Co.	21
Empire Phono Parts Co.	66, 114	Musical Supply & Equipment Co.	31	Victor Talking Machine Co.	Front Cover, 5, 7
Empire Talking Machine Co.	93	Mutual Talking Machine Co., Inc.	67	Insert following page	
Enterprise Music Supply Co.	138	N		Vitanola Talking Machine Co.	94
F		National Decalcomania Co.	116	Volker & Co., M.	173
Faultless Caster Co.	27	National Publishing Co.	6	W	
Favorite Phonograph Accessories Co.	45	New England Musical Instrument Trading Co.	123	Wade, R. C.	59
Federal Sign System.	11	New England Talking Machine Co.	65	Wade & Wade.	101
Ferrara, Ben	140	New York Album & Card Co.	4	Walthall Music Co.	30
Fifer, C. Arthur, Music Co., Inc.	141	New York Recording Laboratories, Inc.,		Ward Co., C. E.	18
Fischer Co.	32	Inside back cover		Wax-Wilson Company.	131
Fletcher-Wickes Co.	35	New York Talking Machine Co.	85	Weber-Knapp Co.	66
Franklin Phonograph Co.	56	Nicholson, K., Furniture Co.	95	Western Veneer Products Co.	26
Fritsch Co.	50	Nightingale Mfg. Co.	Insert following page	Weymann & Son, H. A.	53
Fulton Bros. Mfg. Co.	114	Nye, William F.	58	Whitsit Co., Perry B.	173
Fulton Talking Machine Co.	163	O		Widdicomb Furniture Co.	120
Futch Co., John A.	173	Ohio Sales Co.	30	Williams, G. T., Co., Inc.	161
G		Ogden Sectional Cabinet Co., Inc.	49	Wilson, A. J., & Co., Ltd.	168
Garford Mfg. Co.	22, 96	Operaphone Co., Inc.	146	Wolf, Clifford A.	164
Gately-Haire Co., Inc.	149	Oro-Tone Co.	106	World Phonograph Co.	12
General Manufacturing Corp.	118	P		Wurlitzer Co., Rudolph.	173
Gibson Snow Co.	31	Paragon Mfg. Co., Inc.	18, 131	Y	
Globe Decalcomanie Co.	144	Parker White Metal & Machine Co.	114	Yahr & Lange Drug Co.	30
Glynn, W. B., Distributing Co.	31	Q			
Gramophone Co., Ltd.	165	R			
Grand Rapids Brass Co.	125	S			

Paramount Records

The Popular, All-Hit Line of Independent Records

NOTHING but headliners on Paramount's monthly lists. If it isn't a hit, you won't find it under the Paramount label. They run two to the record—always. "Paramounts" draw trade like a magnet, and they don't gather dust on your shelves, because no weak numbers are offered.

Paramount selling aids—above all, Paramount *superiority*—keep them moving, so that they offer jobbers and dealers the most liberal returns of any leading record on the market.

Ask *today* for the Paramount Proposition. Make your store a Paramount store, establish yourself as the leading dealer in your locality and *profit* by Paramount's growing *popularity*.

The New York Recording Laboratories, Inc.

Port Washington, Wisconsin

Tear Out & Mail Today

DEALERS and Jobbers looking for the All-Hit-Line—Records that meet the popular demand—send in your name on this coupon for immediate attention.

Name _____

Address _____

Ask Us About Paramount Needles. 'Every Point a Sharp Point.'

Music on Both Sides

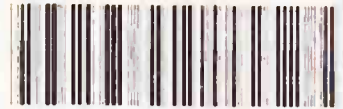

THE NEW EDISON



The Ultimate Choice of Music Lovers

JOBBER'S OF THE NEW EDISON, EDISON RE-CREATIONS,
THE NEW EDISON DIAMOND AMBEROLA AND BLUE AMBEROL RECORDS

CALIFORNIA
Los Angeles—Edison Phonographs, Ltd.
San Francisco—Edison Phonographs, Ltd.

COLORADO
Denver—Denver Dry Goods Co.

CONNECTICUT
New Haven—Pardee-Ellenberger Co., Inc.

GEORGIA
Atlanta—Phonographs, Inc.

ILLINOIS
Chicago—The Phonograph Co.
James I. Lyons. (Amberola only.)

INDIANA
Indianapolis—Kipp Phonograph Co.

IOWA
Des Moines—Harger & Blish.
Sioux City—Harger & Blish.

LOUISIANA
New Orleans—Diamond Music Co., Inc.

MASSACHUSETTS
Boston—Pardee-Ellenberger Co.

MICHIGAN
Detroit—Phonograph Co., of Detroit.

MINNESOTA
Minneapolis—Laurence H. Lucker.

MISSOURI
Kansas City—The Phonograph Co. of Kansas City.
St. Louis—Silverstone Music Co.

MONTANA
Helena—Montana Phonograph Co.

NEBRASKA
Omaha—Shultz Bros.

NEW JERSEY
Paterson—James K. O'Dea (Amberola only).

NEW YORK
Albany—American Phonograph Co.

New York—The Phonograph Corp. of Manhattan.

Syracuse—Frank E. Bolway & Son, Inc.

W. D. Andrews Co. (Amberola only.)

Buffalo—W. D. & C. N. Andrews Co. (Amberola only.)

OHIO

Cincinnati—The Phonograph Co.

Cleveland—The Phonograph Co.

OREGON

Portland—Edison Phonographs, Ltd.

PENNSYLVANIA

Philadelphia—Girard Phonograph Co.

Pittsburgh—Buchn Phonograph Co.

Williamsport—W. A. Myers.

RHODE ISLAND

Providence—J. A. Foster Co. (Amberola only.)

TEXAS

Dallas—Texas-Oklahoma Phonograph Co.

UTAH
Ogden—Proudfit Sporting Goods Co.

VIRGINIA
Richmond—The C. B. Haynes Co., Inc.

WISCONSIN
Milwaukee—The Phonograph Co. of Milwaukee.

CANADA
Montreal—R. S. Williams & Sons Co., Ltd.

St. John—W. H. Thorne & Co., Ltd.

Toronto—R. S. Williams & Sons Co., Ltd.

Vancouver—Kent Piano Co., Ltd.

Winnipeg—R. S. Williams & Sons Co., Ltd.

Calgary—R. S. Williams & Sons Co., Ltd.