

The TALKING MACHINE WORLD

For dealers
wholesalers
& manufacturers
of phonograph
& radio products

Published Each Month by Edward Lyman Bill, Inc., at 383 Madison Avenue, New York, December 15, 1926

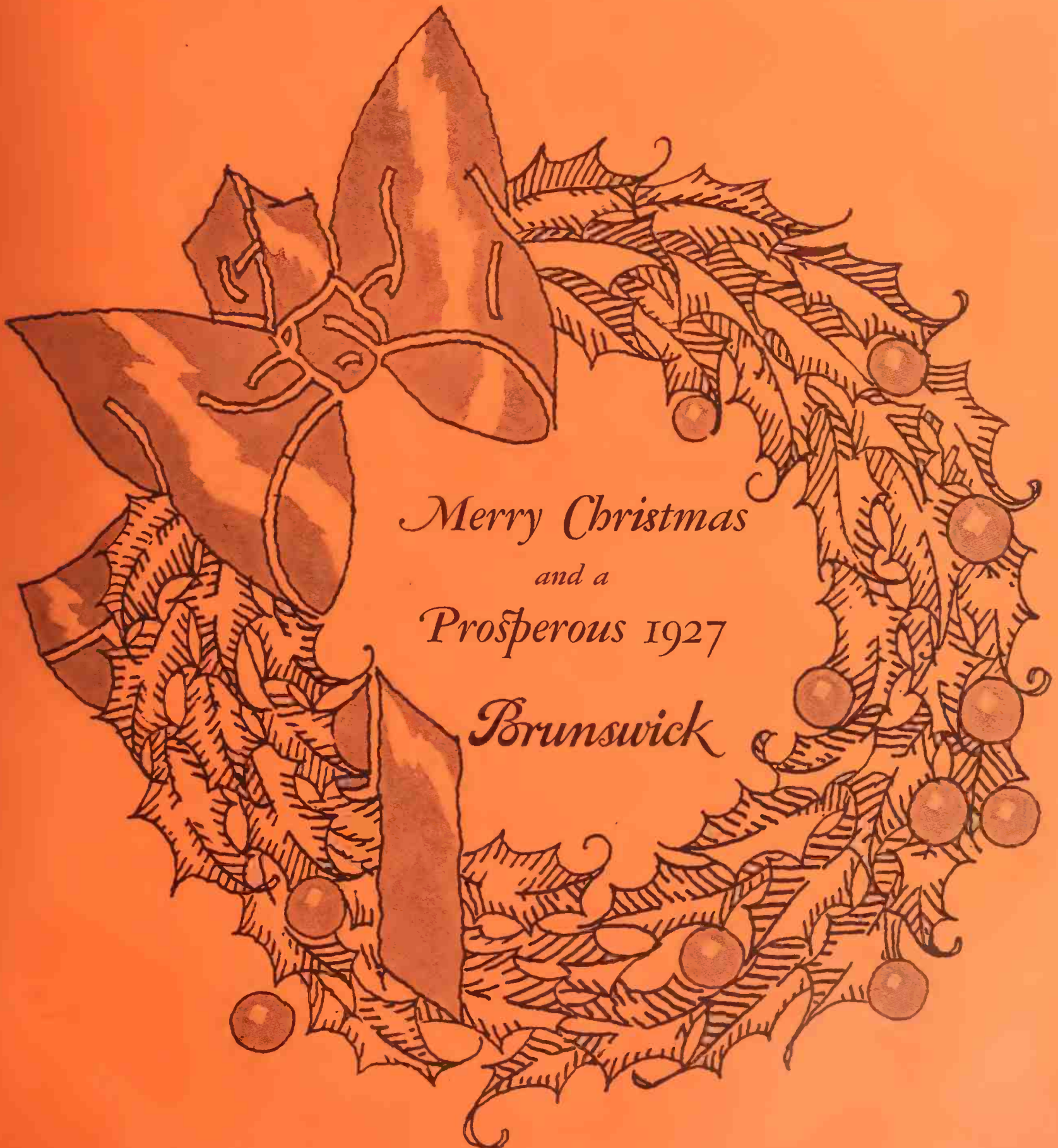

Merry Christmas

and a

Prosperous 1927

Brunswick

OCEAN

DEEP

TONES



The
Sonora
Shielded Six
\$125

The Talking Machine World

Vol. 22. No. 12

New York, December 15, 1926

Price Twenty-five Cents

Important European-American Deals Have Been Consummated by the Brunswick Co.

P. L. Deutsch, Vice-President of the Brunswick Co., Gives Details Regarding Vital Expansion for Brunswick in Europe—Deals Closed Will Add Substantially to Brunswick Fame and Prestige

Two important negotiations have been consummated by the Brunswick-Balke-Collender Co. which will give their product wide European distribution and at the same time bring to the Brunswick trade here one of the most comprehensive foreign language record libraries in Europe. It was disclosed in New York, last week, by P. L. Deutsch, vice-president of the Brunswick Co. and general manager of its music-radio division who recently returned from abroad where he represented the company in final conclusions with the Deutsche Grammophon Co., at Berlin and the British Brunswick, Ltd., at London. He was accompanied to New York by B. Borschardt, the Deutsche Grammophon managing director who conferred with the Brunswick Co. officials in New York.

The Deutsche Grammophon Co. is located in Berlin and is the producer of records under the trade name of "His Master's Voice" for sale in Germany, and Polydor in Germany and other countries, the company having been formed in 1919 by a group of financiers and business men there to succeed to the business of a predecessor company. Famous European artists and symphony orchestras are under contract to the "His Master's Voice" catalog in Germany, while under the Polydor label a varied repertoire of the music of many nations is maintained, to all of which the Brunswick Co. in America will have access and at the same time the exclusive dance repertoire, as well as the balance of its catalog will be offered to the German public.

The sale of Brunswick records in Germany and other countries through the new connection may be foreseen to be along aggressive, but sound and conservative lines and in view of

the fact that business, in general, of the German republic is of such a healthy tone, there is no question that there will be a lively demand there for the Brunswick product.

Mr. Deutsch said further that as part of the



P. L. Deutsch

deal the electrical recording and reproducing rights of the General Electric Co. will become available to the Deutsche Grammophon Co. through the German General Electric Co. so that its new recordings from now on will be made by the "Light Ray" method and may be expected to exhibit the same advance in tech-

nique that electrical recording has produced in the United States.

A further important factor in this agreement is the manufacturing and selling of the Brunswick Panatrope and Brunswick phonographs in Germany and Austria by the Deutsche Grammophon Co.

The large and complete catalogs of the Deutsche Grammophon Co. comprise such famous artists as: Erica Morini, Frieda Hempel, Alfred Piccaver, Leo Slezak, Heinrich Schlusnus, along with complete symphony works of Beethoven, Mozart, Haydn, Bach, Liszt, Wagner and others rendered by leading orchestras and interpreted by such famous masters as Richard Strauss, Bruno Walter, Nikisch, Otto Klemperer, Leo Blech and Furtwaengler. The Polydor International Library is stated to cover German, French, Bohemian, Slovak, Italian, Spanish, Roumanian, Scandinavian and kindred music and is expected to form a valuable addition to the Brunswick record line throughout America. Mr. Deutsch said that the first matrices from the Berlin connection will arrive shortly and that the trade service for the Brunswick retail contingent will be established as rapidly as possible.

The British Brunswick, Ltd., a newly formed company, in which the Brunswick-Balke-Collender Co. has a substantial interest together with that of British capital, will record and manufacture in England electric records and Brunswick Panatropes through an arrangement made with the Thompson Houston Co. for the exclusive use of the electrical recording and reproducing rights which they control with the General Electric Co. At the same time there will also be an interchange of matrices between the British Brunswick, Ltd., and the Brunswick-Balke-Collender Co. as well as between the British Brunswick, Ltd., and the Deutsche Grammophon Co. and in the broadened field of activity there will be an aggressive sales policy.

New York Bankers Secure Control of the Victor Talking Machine Co.

President E. R. Johnson Disposes of His 245,000 Shares of Stock in the Company to Speyer & Co. and J. & W. Seligman—Over \$40,000,000 Involved in Deal

The largest single business transaction ever recorded in the music trade was consummated on Tuesday afternoon of last week, when the control of the Victor Talking Machine Co. passed into the hands of the Wall Street banking firms of Speyer & Co. and J. & W. Seligman, through the agreement to purchase the 245,000 shares of common stock in the company held by Eldridge R. Johnson, its founder, president and principal owner. The bankers will pay \$115 a share for Mr. Johnson's stock, and it is stated that the same offer will be made to the minority stockholders. There are altogether 348,863 shares of Victor common stock outstanding.

It is stated that Mr. Johnson decided to dispose of his holdings owing to the condition of his health and his desire to be free from business cares. The deal will call for the payment to him alone of \$28,175,000.

Representatives of the banking syndicate and the Victor Co., on December 7, deposited a majority of the common stock, 245,000 shares, with the Camden Safe Deposit and Trust Co., thus binding the transaction.

Following the announcement of the sale of his stock to the bankers, Mr. Johnson issued the following statement to the stockholders of the company:

"Influenced greatly by the condition of my health and my consequent desire to be relieved from business cares, I have, this day, given an option to Speyer & Co. and J. & W. Seligman & Co., bankers, for the purchase of all of my holdings of common stock in the Victor Talking Machine Co. on the basis of \$115 per share, the purchasers to receive in the event of their exercising such option all dividends, if any, paid or declared on or after December 6, 1926, as well as any subscription or other rights appurtenant to such stock.

"I have stipulated in the above agreement that if the option is exercised the holders thereof shall offer to purchase from all of the other holders of common stock of the Victor Talking Machine Co. all or any part of their said common stock holdings at not less than said price, to wit, \$115 per share, the purchasers, as stated above, to receive all dividends paid or declared thereon on or after December 6, 1926, as well as all subscription or other rights appurtenant to such stock on or after said date. The holders of said option have agreed to make this offer to you within fifteen days after they exercise such option, unless they make such offer to you at an earlier date. The purchasers have advised me that it is their intention to preserve the continuity of the present management and

personnel and the standard of high quality which has been the distinguishing characteristic of the company since its earliest days.

"You will understand that it is not my wish or intent to influence you in any way in any decision you may make regarding your shares of stock in the Victor Talking Machine Co., but I have been so intimately associated with the management and control of the company since its inception that I did not feel it fair to others who have invested their money in the enterprise that I should dispose of my shares without providing that they should have an opportunity, if they desire, to dispose of their shares upon at least as favorable terms as myself."

Mr. Johnson, a mechanic with very limited means, became interested in the phonograph in its early days, and in 1894 launched his own company in Camden for the purpose of producing Victor machines playing what were then the new disc records. In 1901 the Victor Talking Machine Co. was incorporated and from that day and until July, 1925, the company paid generous dividends to its stockholders. As early as 1912 there were paid regular dividends of 10 per cent and special dividends to the same amount. In 1916, for instance, there was a 20 per cent regular dividend and a 60 per cent extra. Regular dividends of 40 and 45 per cent were frequent, and in 1922 a 600 per cent stock dividend was paid. It was not until July, 1925, that the company found its business in such shape that it was considered necessary to pass a dividend. Dividend payments were resumed, however, on August 6 of this year.

(Continued on page 112)

More sales of records bring success on far more complete scale for live retail dealers

Greater Profits by Exploiting New Records

The record department gives the retailer a repeat business — record sales increase profits

By William Braid White

The salesword of the moment is, or should be, "sell more records."

This does not mean that sales policy should neglect the sale of the new machines, which are doing their very large part in bringing about that renaissance of the phonograph industry which we are all so happy to perceive and to participate in. Rather, it means that the way to a still greater and permanent success in the future is by the road of record distribution. The people of this country have never been educated to the point of becoming record enthusiasts. This was because in the early days of talking-machine expansion the amount of territory to be covered was so enormous that a very large aggregate distribution could be had upon a very small individual consumption. It was rather like the business notions of Colonel Mulberry Sellers, who had been told that each of the four hundred millions of Chinese had had eyes, and calculated that therefore they all needed eye-water; so that the sale of one bottle of eye-water only per unit of that population would provide millions of profit. There were indeed slight though effective obstacles in the path of the ingenious promoter; but if one puts aside the question of sales resistance, which stumped Colonel Sellers, the talking machine industry will have to confess that for a long time it rode to prosperity upon a Sellerian horse. A population growing from ninety to more than a hundred millions within a decade or so made for deceptively large output figures. If one person in every ten bought one machine once in a lifetime that meant ten millions of machines. And if each of those ten machine owners bought five records per year, that meant fifty millions of records. Which all looks very big, and is big; but it does not reveal, until analyzed, its actual weakness as a basis for building prosperity. For, in truth, we began to find out in due course that the difficulty lay in the coming of that day when the one-machine-in-a-lifetime-and-five-records-per-year class of the population should be pretty well satisfied. And then the question became one of "what to do." And it is the answer to that question which is here given.

That is to say, I make here no plea for the neglect of any department of phonograph selling. I merely point out that one department has been badly neglected in the past and that if only as much good work be done in the future on record sales, per individual machine owner, as has been done in days past in placing machines all over the country, the phonograph business will be placed upon a pedestal of prosperity from which nothing can ever pull it down.

But it is also proper to say, and to insist, that the future foundations must be struck

The greatest opportunity for the retail talking machine dealer to build for permanent success and to increase his volume of profits lies in the more vigorous exploitation of the record department. Record sales can be built up to a volume that will bring in a steady stream of cash. Push the records you handle.

deep. There is only one bedrock on which to place those foundations, and that is the rock of record consumption. It is essential to build up among the present and future owners of talking machines an adequate interest in the musical treasures of the record catalogs. Once get even a strong minority of the buying public into the habit of adding periodically to their stocks of records, and the foundations of prosperity will have been struck right down to that bedrock from which they never can be dislodged.

The phonograph and its records constitute together an art preservative of art. They not merely reproduce, they record. That is to say, they give one a "library" of records, a library

from whose shelves one can pick music as one picks books, when and as often as one wants them. It is the difference between having what one wants when one wants it and having what someone else wants when someone else wants it. This is fundamental.

But it must once more be said that the way to this desired permanence and prosperity is along the road of record consumption. It is essential to build up interest in record buying. How this is to be done has often been told in my own articles in this paper, as well as by many expert merchandisers in these same columns from time to time. One principle shall for the moment suffice. There is nothing much to be done save by general publicity to build up more record buying among that large part of the public which takes its aesthetic pleasure mainly through its pedal extremities; in other words, among the dancing people. They will buy the latest dance records anyhow and the best way to deal with them is to advertise steadily and persistently what one has of the wares that appeal to their taste. There is, however a large and intelligent minority of music lovers only waiting to be convinced that the modern phonograph and records are really what they are said to be. The process of convincing is easy, for the phonograph of to-day really does what it claims to do. The future prosperity of the phonograph industry is in the hands of this minority. It is not so small a minority either. And it is mainly composed of the not-quite-so-young people. This minority has been badly neglected. Judicious remedy of that neglect is quite possible and practicable; and no wise dealer will fail to take this truth into account while he is rebuilding his sales policies upon broader and sounder and more permanent foundations.

The installation of phonographs and several loud speakers in different departments of the Newark plant of the Westinghouse Co. has had the effect of offsetting monotony, fostering contentment of the workers and brightening the entire work place.

Holiday Greetings

WE express our appreciation of the patronage and co-operation that we have received during 1926 and extend to the trade our wishes for

**A Merry Christmas
and
A Prosperous 1927**

NEW YORK ALBUM & CARD CO., Inc.

Established 1907

23-25 Lispenard Street

NEW YORK

Makers of Nyacco Albums, Nyacco Radio Sets and Nyacco Portable Phonographs and Radio

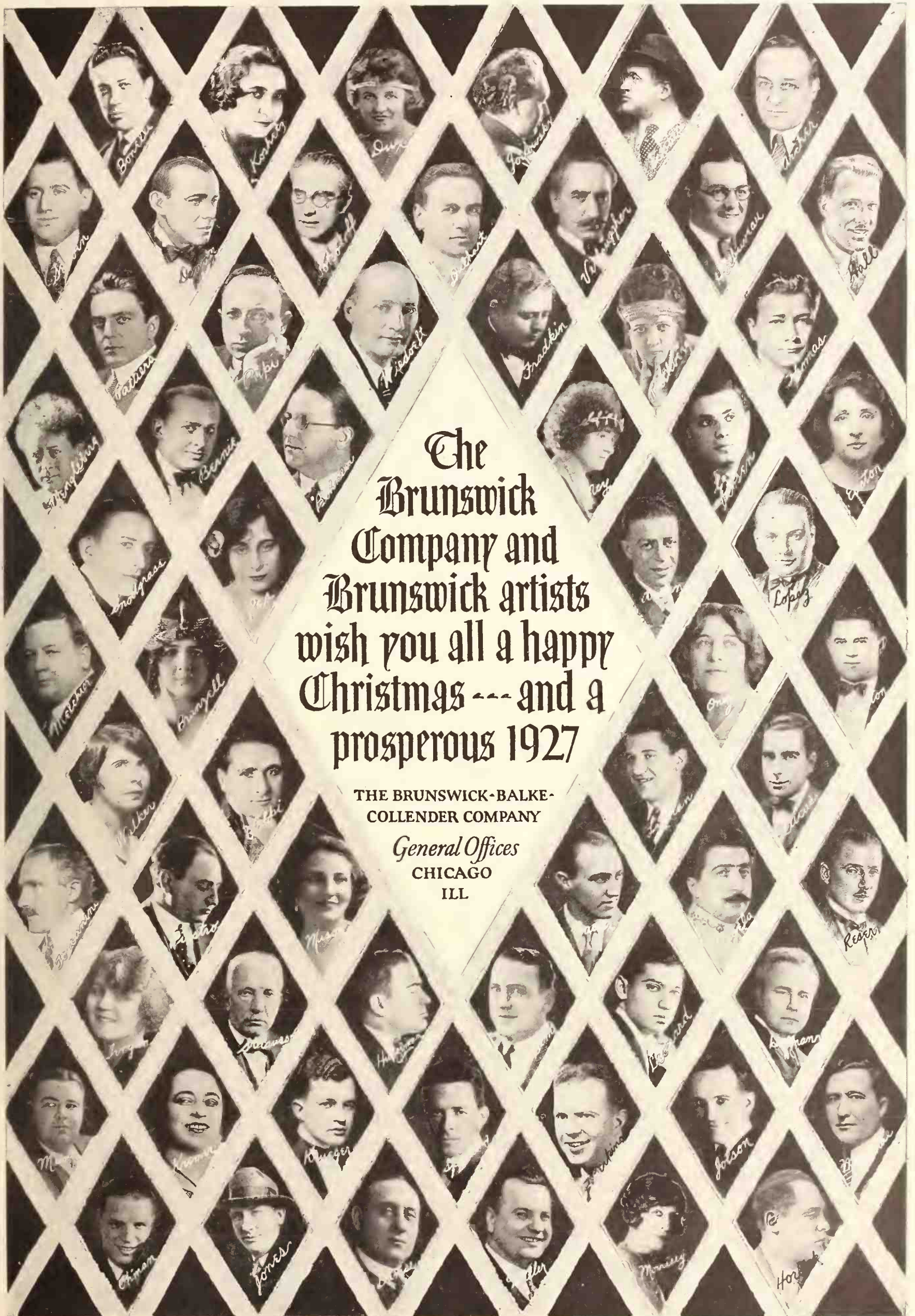

The
 Brunswick
 Company and
 Brunswick artists
 wish you all a happy
 Christmas --- and a
 prosperous 1927

THE BRUNSWICK-BALKE-
 COLLENDER COMPANY

General Offices
 CHICAGO
 ILL

W. H. Lynas Makes Interesting Analysis of Status of Radio Industry in Europe

Managing Director of Graham Amplion, Ltd., of London, a Visitor to This Country, Declared That the Radio Industry Throughout Europe Is Constantly Growing in Strength

W. H. Lynas, managing director of Graham Amplion, Ltd., of London, England, arrived in this country recently on the "Berengaria" to spend a few weeks visiting the trade here and in Canada. Mr. Lynas, who is making his headquarters at the offices of the Amplion Corp. of America, expects to return to Europe within the next few days and in the meantime is conferring with S. B. Trainer, president, and Lloyd L. Spencer, sales manager of the Amplion Corp. of America, regarding extensive plans for expansion during the coming year.

Mr. Lynas, who is internationally prominent in radio circles, needs no introduction to the radio industry in America, for he visits here frequently and also attended the 1925 and 1926 conventions of the R. M. A. at Atlantic City, where he was one of the speakers. Graham Amplion, Ltd., maintain world-wide affiliations which give Mr. Lynas an opportunity to keep in close touch with radio activities throughout Europe, Great Britain and the English Colonies. The companies associated with Graham, Ltd., in the manufacturing and marketing of Amplion radio products are located all over the world and comprise Alfred Graham & Co., Ltd., London, Eng., Amplion Corp. of America, New York City; Amplion Corp. of Canada, Ltd., Toronto, Canada; Compagnie Continentale Amplion, Brussels, Belgium; Compagnie Francaise Amplion, Paris, France; Amplion (Australia), Ltd., Sydney, Australia; Etablissements Belges Amplion, Brussels, Belgium; Radio Presse Internationale, Brussels, Belgium; Radio Press-Paris, Paris, France; Deutscher Amplion Vertrieb, Frankfurt-on-Main, Germany.

In a chat with The World Mr. Lynas gave

an interesting resumé of the general status of the radio industry in Europe, stating: "The radio industry throughout Europe is in very healthy shape, gaining in strength and stability at a very satisfactory rate of progress. The sales, of course, are nothing like the volume in America, but the business is on a firm foundation with the sales curve on a more even and steady plane during the active season than in this country. In practically all of the leading European countries there is a steady demand for radio products during the Fall and Winter months which does not show the sharp increases and decreases which apparently are still a factor in practically every section of America.

"At the present time the subject of broadcasting is receiving the attention of every member of the radio industry in America, but in this particular respect Europe seems to be quite some distance ahead of the radio industry here. As is generally known, radio broadcasting throughout Europe is in the hands of various Governments which receive the co-operation of the International Broadcasting Conference. This important and well-established association has headquarters in Geneva and meets at frequent intervals in the various European trade centers. Broadcasting throughout Europe is regulated in such a way that there is absolutely no interference with the wave lengths allocated to the respective broadcasting stations. The wave lengths which are assigned to the stations are followed rigidly without complaint or protest and there is a spirit of co-operation which is proving of immeasurable value to every phase of the radio industry. For example, several stations in England voluntarily relinquished re-

cently their rights to certain wave lengths because they were interfering with broadcasting from several points in Europe. These wave lengths were allocated to other stations and the situation was adjusted to the complete satisfaction of all concerned.

"The output of the various broadcasting stations in Europe seems to be more stabilized than the average output of the American broadcasting stations. Programs are maintained on a definite, concrete basis and are not influenced by the particular time of the day when they are presented. At times, of course, the quality of the programs may suffer in comparison with the extensive repertoires of the American broadcasting stations, but there is a stability to the output of the European stations that is proving a valuable contribution to the success of the radio industry.

"During the past year the sale of radio products throughout Europe has shown a very substantial increase over 1925 and, although there have been no radical changes in the product itself, the industry is steadily marching forward. I find, in this country, that the most material changes appear in the design of the product rather than the basic construction; and this condition is similar to the European radio industry. It is in broadcasting primarily that Europe shows a marked advance over America, and the service given to the owners of radio receivers is steadily increasing in proportion to the growth of the trade. A valuable feature, for instance, is the broadcasting from London at a specified time each evening of the important news of the day, sponsored by a group of world-famous news associations. This resumé of news happenings is followed closely by every owner of a radio receiver, who, regardless of his distance from the city itself, is enabled to keep in close touch with the news of the day. The Government does not permit commercial broadcasting of any type whatsoever, and every program that is broadcast must receive an official okay before it is given over the air.

"I am greatly pleased with the exceptional progress which Amplion products have made in America and Canada the past year, and our sales figures are very satisfactory. We have plans in contemplation for 1927 which will undoubtedly prove of considerable interest to our distributors and dealers and which will be announced by Mr. Trainer very shortly. I am looking forward to a healthy, prosperous radio year in 1927 with the industry showing a stability commensurate with its world-wide progress of the past four years."

Columbia 1927 Catalog Ready for Distribution

Entire Library of Columbia Recordings Presented in a Most Complete Fashion

The 1927 record catalog of the Columbia Phonograph Co., New York, is just off the press and it presents in a most complete and well-arranged fashion the entire library of Columbia recordings. The first section of the catalog is given over to an alphabetical list of record titles, followed by an alphabetical index of artists and an alphabetical index of composers, so that the dealer can readily find a record no matter how meager is the information presented by the inquirer.

The next section lists and reviews the forty-four Columbia Musical Masterwork album sets with short summaries of the works and their composers. Next follows the listing of concert and operatic selections presented under the name of the recording artist. In the order named following this section are listed standard and popular records, race records, old familiar melodies, Irish series and the educational series. The catalog is printed on a fine grade of paper with clear readable type and the book is profusely illustrated with photographs of world-famous Columbia artists.

This Line Leads to Greater PROFITS



6 Tubes, 2 Controls \$75⁰⁰
4 in. Solid Mahogany Cabinet



No. 60B, \$100



No. 60C, \$125



No. 60D, \$170

Easier and Quicker Sales—Larger and Surer Profits for you!

Profitable selling does not just happen. It is the result of carefully planned and carefully carried out manufacturing and selling plans.

CASE Radio Receivers assure the radio dealer easier and quicker sales with larger and surer profits for these three reasons:

1. Six-tube tuned radio frequency sets of unusual performance ability.
2. Attractive low prices—liberal dealer profits.
3. National advertising and dealer helps.

CASE advertising reaches 8,100,000 families—many of them in your community. The CASE merchandising plan helps you get the greatest benefit and profit from that advertising.

A Reputable Product—A National Institution with over 500 Jobbers

CASE Radio Receivers have five years of successful performance to their credit. They are made in a complete range of table and console types to fit every purse. CASE sales have grown steadily every year—CASE dealers have made more money each year.

CASE Sets are manufactured by a well-established, well-financed organization that does business on a sound, conservative basis, assuring greatest satisfaction and profits for all concerned.

Write today for complete literature and information

INDIANA MFG. & ELECTRIC CO.
MARION, INDIANA

CASE
RADIO PRODUCTS

DEALERS DELIGHTED

WITH

New 5-Tube Receiver



The White Music Shops, Inc.
 110 W. 42nd St., New York City
 We are delighted to have installed the new 5-tube Receiver in our store. It is a great relief to dealers to be able to concentrate more firmly on the Stromberg-Carlson line because of your new and broader scale of prices.

HAYNES GRIFFIN, Inc.
 41 West 41st Street, New York City
 We have received and installed the new 5-tube Receiver in our store. It is a great relief to dealers to be able to concentrate more firmly on the Stromberg-Carlson line because of your new and broader scale of prices.

GRANTHAM & RAMSEY
 GENERAL MERCHANDISE
 110 W. 42nd St., New York City
 We are delighted to have installed the new 5-tube Receiver in our store. It is a great relief to dealers to be able to concentrate more firmly on the Stromberg-Carlson line because of your new and broader scale of prices.

United Music Co.
 110 W. 42nd St., New York City
 We are delighted to have installed the new 5-tube Receiver in our store. It is a great relief to dealers to be able to concentrate more firmly on the Stromberg-Carlson line because of your new and broader scale of prices.

No. 502 Receiver, Art Console, 5-tube; coils shielded; operates from house current or batteries; space for socket power units or batteries. Price, less accessories but including external Cone Speaker

East of Rockies	Rockies and West	Canada
\$325	\$355	\$380

No. 501 Receiver, same operating unit as No. 502. Price, less accessories without Cone Speaker

East of Rockies	Rockies and West	Canada
\$180	\$192.50	\$225

I find the No. 501 Receiver is no exception to the excellent standards which you have established in your other models . . . it is a great relief to dealers to be able to concentrate more firmly on the Stromberg-Carlson line because of your new and broader scale of prices.

I anticipate a very heavy demand for these Five Tube sets, and trust that your production is going to be adequate enough to take care of the demand.

Haynes-Griffin, Inc., New York City

We have received and installed the new 5-tube Treasure Chest Receiver. We are delighted with it and wish to compliment the Stromberg-Carlson Co. for producing this model, as we find it to be very suitable for the majority of homes.

We intend to feature this Receiver in our sales campaign this season and expect it to be our most popular model.

Gray, Trimble & Smith Electric Co., Bloomington, Ill.

We wish to compliment you on the new Model 501 Receiver in regard to everything connected with it, i.e., quality of materials, workmanship, appearance and the results obtained from it.

There is nothing too complimentary which we can say in regard to the 501. The only drawback which we can possibly think of is that we may not be able to get enough of these instruments to supply our customers wants.

United Music Company, New London, Conn.

We have just received the new No. 501 Receiver and having tested it out will say that it is certainly a step forward in radio. We never yet have seen a set so powerful and selective . . . when used with a Stromberg-Carlson Cone Speaker it has the finest tone we have ever heard.

We are certainly glad to have this set added to the Stromberg-Carlson family and believe it will be the biggest seller yet.

Grantham & Ramsey, Kaw City, Oklahoma

INFLUENCED by the flood of public approval, Stromberg-Carlson dealers in every section of the country are voicing their enthusiasm over the new 5-tube Receivers.

For these dealers are reaping increased profits from this broadened Stromberg-Carlson field of radio merchandise—and are enabled to concentrate more firmly on a line which represents permanence of value.

Stromberg-Carlson Telephone Mfg. Co., Rochester, N. Y.



Stromberg-Carlson

Makers of voice transmission and voice reception apparatus for more than thirty years.

W. R. Davis Appointed Priess Vice-president

In Charge of Sales—Julius V. Cremonim Named Assistant to New Vice-President and Manager of Foreign Sales Department

The Priess Radio Corp., 695 Broadway, New York City, of which William H. Priess, the well-known radio engineer, is the head, recently announced the appointment of William R.



W. R. Davis

J. V. Cremonim

Davis as vice-president in charge of sales, and Julius V. Cremonim as assistant to the new vice-president and manager of the foreign sales department.

Mr. Davis has had radio experience dating from 1906, when he was associated with Professor Fessenden in Government experimental work. Later he joined the forces of the Magnavox Co., where for a period of five years he held the post of sales manager.

Julius V. Cremonim has been with the Priess organization for some time, first in the capacity of sales representative and later as assistant sales manager with complete charge of export sales. As in the case of Mr. Davis, Mr. Cremonim has a background of engineering training as well as sales experience. He is a

graduate electrical and mechanical engineer and has studied export conditions in both Europe and South America. He speaks fluently English, Spanish, Portuguese, Italian, French and German.

Discussing his new association with the Priess Radio Corp., Mr. Davis said: "I am extremely glad of the opportunity this new connection affords me. We have only one unit of sale—the Priess Straight Nine—and my undivided effort can be given to it."

Ross Kenyon Now Treasurer Sleeper Radio & Mfg. Corp.

Announcement of the election of Ross Kenyon as treasurer of the Sleeper Radio & Mfg. Corp., Long Island City, New York, has been announced by Gordon C. Sleeper, president. Mr. Kenyon practiced law for several years before entering business as treasurer of the Northam-Warren Corp., where he served for five years in this capacity. Other officers of the Sleeper Co. are Herbert C. Doyle, vice-president and George O. Castelle, secretary.

Awarded Victor Franchise

David M. Isaac, of 1473 Myrtle avenue, Brooklyn, N. Y., was recently awarded the Victor franchise and now carries a complete line of Victor Orthophonic instruments and records. Among the radio lines carried by Mr. Isaac are the R. C. A., Atwater Kent, Freshman, Grebe and Ambassador.

Victor dealers of Tacoma, Wash., made a concerted drive to introduce to the residents of this city the new Orthophonic records.

The Officers Club of Fort Sam Houston, San Antonio, Tex., has purchased one of the new Viva-tonal Columbia phonographs from the San Antonio Music Co.

Interesting Facts About Radio's "Missing Notes"

L. C. Lincoln, Advertising Manager of F. A. D. Andrea, Inc., Describes the Feature That Distinguishes Cone Speakers From Others

The story of the "missing notes" in radio was related recently by L. C. Lincoln, advertising manager of F. A. D. Andrea, Inc. In many years' experience in the music field, Mr. Lincoln has made a special study of reproducing devices.

"A very important element of a receiving set is the reproducing device," said Mr. Lincoln. "The three principal elements, the tubes, the receiver and the speaker, must work in harmony for best results. This combined result has created a new term in radio, 'harmonated reception.'

"The average human ear can respond to sound vibration from as low as 30 per second to upwards of 10,000 per second, and the ordinary music range may be considered from 30 per second, which corresponds to the low notes of an organ, to upwards of 4,000 per second. It is very seldom, however, that a note as high as 4,000 per second is encountered. The lowest tone in an orchestra, for example, is that of the double bass viol, with 42 vibrations per second, while the piccolo climbs to over 4,700.

"Obviously the speaker should give uniform response throughout the entire musical range. An effective and balanced response to all notes in the musical scale is essential for true reproduction. Most speakers in the past have failed to give any satisfactory response to vibrations under 200 per second. These are the 'missing notes,' and reproducing them effectively and efficiently is a feature that distinguishes the latest development in cone speaker design from practically all other radio reproducers."

PEERLESS ALBUMS and PORTABLES

Get your share of the Holiday Gift money. Record Albums make most appropriate presents and when sold create heavy record sales.

Display Albums and you will sell Albums—and Records too



Genuine Leather Covered
Peerless Portable
In Black, Brown and Blue



\$25⁰⁰
Retail

The Peerless Portables—covered with genuine leather—are remarkable values at \$25.00. The purchaser immediately notes the difference in quality leather—and sees the added value of these rich instruments as gifts.

Write for Sample of the above and ask about our wonderful value in the Peerless \$15.00 Portable

PEERLESS ALBUM CO.

PHIL. RAVIS, President

636-638 BROADWAY, NEW YORK

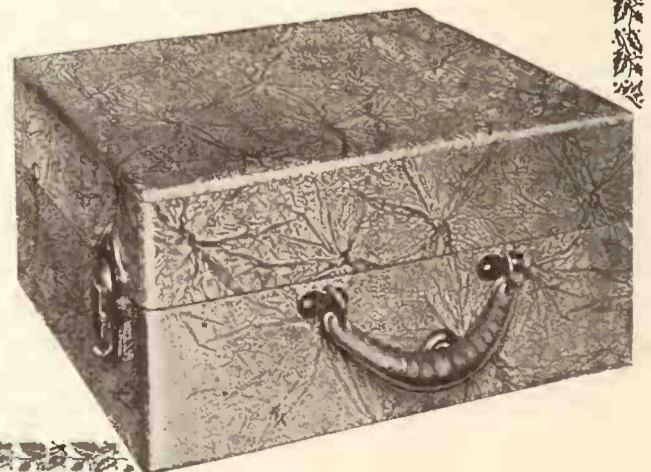

Now's the Time

Money gifts and bonuses
at this time of the year
present a very great buy-
ing power.

What real serious effort
are you making to get your
share, Mr. Victor Dealer?



C. Bruno & Son, Inc.

Victor Wholesale Exclusively

351 Fourth Avenue

New York City

1834—Over 92 Years of Dependable Service to the Music Trade—1926



(Registered in the U. S. Patent Office)

PUBLISHED BY EDWARD LYMAN BILL, Inc.

President, C. L. Bill; Vice-Presidents, J. B. Spillane, Edward Lyman Bill, Randolph Brown; Treasurer, Raymond Bill; Secretary, E. L. Bill; Assistant Secretary, L. E. Bowers; Assistant Treasurer, Wm. A. Low.

J. B. SPILLANE, Editor

RAY BILL, B. B. WILSON, BRAID WHITE, Associate Editors

C. R. TIGHE, Assistant Editor

LEE ROBINSON, Business Manager

Frank L. AVERY, Circulation Manager

Trade Representatives: VINCENT D. WALSH, E. B. MUNCH, VICTOR C. GARDNER, V. E. MOYNAHAN, ROYCE CODY, A. J. NICKLIN

Western Division: Republic Building, 209 So. State Street, Chicago, Ill. Telephone. Wabash 5242. LEONARD P. CANTY, Manager.

Boston: JOHN H. WILSON, 324 Washington Street.

London, Eng., Office: 2 Gresham Building, Basinghall St. W. LIONEL STURDY, Mgr. The Talking Machine World has regular correspondents located in all of the principal cities throughout America.

Published the 15th of every month at 383 Madison Ave., New York

SUBSCRIPTION (including postage): United States, Mexico, \$2.00 per year; Canada, \$3.00; all other countries, \$4.00. Single copies, 25 cents.

ADVERTISEMENTS: \$6.50 per inch, single column, per insertion. On yearly contracts for display space a special discount is allowed. Advertising pages, \$172.00.

REMITTANCES should be made payable to The Talking Machine World by check or Post Office Money Order.

NOTICE TO ADVERTISERS—Advertising copy should reach this office before the first of each month. By following this rule clients will greatly facilitate work at the publication headquarters.

Long Distance Telephones—Numbers 2642-3-4-5-6-7-8 Vanderbilt
Cable Address: "Elbill," New York

NEW YORK, DECEMBER 15, 1926

Straightening Out the Air Tangle

THE confusion in the air which has followed the decision of the Federal courts some months ago, to the effect that the Department of Commerce did not have power under existing statutes to regulate the operation of radio broadcasting stations and to specify the wave lengths upon which such stations can operate, has resulted in strong pressure being brought upon the Congress which is now in session in Washington to pass one or the other of the bills before it designed to regulate radio traffic in the air. The subject has aroused national interest.

Local court actions in Chicago and elsewhere have served for the moment to regulate this air traffic to an extent by injunction, but the remedy is admittedly only temporary and does not extend far enough to grant protection to non-protesting stations, which suffer from the operation of others who have entered the field or have seen fit to move about on the limited wave band.

The situation is one in which the manufacturer and retailer of radio apparatus are deeply concerned, for present and prospective radio fans are beginning to show a distinct reaction as a result of the confusion in radio programs. In many localities, particularly in or near the larger centers where numerous stations operate, it requires a receiver much more selective than the average to enable the listener-in to get his programs clearly and without interference. The result is that owners of receivers are making loud complaints to dealers about trouble in operating their sets, and numerous reports are on record of prospective customers who hesitate to buy because of what their friends tell them and what they read regarding the conditions in the broadcasting field.

"Freedom of the air" sounds very fine as a slogan, and it appears well in print, but does not work out in practice. The point is that, if radio broadcasting is to be a part of our present-day scheme of things, the public must be protected in its efforts and desires to listen without undue interference to what is put on the air.

It is time for the industry as well as for the public to insist that the conference committee smooth out its differences and so reconcile the provisions of the White and Dill bills—or provide a

substitute—to the end that satisfactory legislation be enacted. The Dill Bill sponsored by the Senate places the control of radio broadcasting with a Federal Radio Commission of five members to be created, while the White Bill sponsored by the House, to accomplish the same end, places radio control with the Department of Commerce. Various other phases of the bills can easily be adjusted if the spirit is there, and pressure by every interested party should be brought to bear while the new Congress is in session to bring about such an adjustment.

The National Radio Co-ordinating Committee has aired its views and made its claims and it rests now with the retail trade itself, so vitally interested and in such close touch with the public, to demand of Congress some type of legislation that will provide proper control of the air as a protection to the millions who already own radio receivers and to the other millions who may be expected to buy. It may be that during the short session of Congress, with the many things of importance to come up before that body, there may not be the time to iron out differences relative to permanent legislation. In such an event it would be well for the trade and the public to urge that some temporary or emergency legislation be enacted that will grant desired relief until such time as the permanent bill can be passed. The importance of the matter cannot be overemphasized.

It's the Effort, Not the Market, That Fails

FOR those who are fond of declaring that the buying power of the American public has been curtailed, and that the growth of instalment buying has served to deplete the present and future cash resources of the nation, there is little comfort in the Government report to the effect that there is at present something in excess of \$50,000,000,000 on deposit in the banks of the country, of which approximately half represents deposits in savings banks.

The important thing is that these deposits are earning, it is estimated, some \$800,000,000 a year in interest, part of which remains in the banks, but a very substantial proportion, including that accumulated in Christmas funds, is put back into circulation through the medium of general purchases. Regarding industrial conditions, the Government reports them to be altogether satisfactory, with practically no unemployment and with most industries on a full-production schedule.

These Federal statements reflect the continued prosperity of the country, and the problem that is faced by the average retailer, whether in the music field or some other line of business, is not that of facing a failing market, but of meeting a steadily increasing volume of competition from all directions. In short, there is plenty of money in the hands of the American people to be spent, but there seems to be a host of energetic salesmen after each dollar. The matter resolves itself into first-class salesmanship, both through the printed word that creates the desire, and through personal contact which crystallizes the desire into the actual purchase.

Assuming that many millions of dollars are to be spent within the next month or so in holiday and post-holiday buying, it is not sufficient for the dealer to sit quietly by and wait for some of those dollars to walk into his store. There are too many other dealers by the wayside to interfere with the parade. The buying power of the country so far as the individual retailer is concerned rests entirely on his ability to control a proper share of that power to his own end. For the laggard hard times will always be here.

Authoritative Information Is Important

MANUFACTURERS in the talking machine and radio industries who seek to branch out into foreign fields on a serious basis have no occasion to go pioneering in the broad sense of the word or to depend upon advice and information of doubtful value from sources ill equipped to render any real service to the exporter.

The American manufacturers collectively have been and are supporting at a cost of some \$3,000,000 annually a foreign trade promotion service as a part of the Department of Commerce that has proved its value by producing directly and through its own efforts a volume of business annually that is many times in excess of the cost of the work. The Bureau of Foreign and Domestic Commerce stands ready upon request to make surveys of definite foreign fields for domestic manufacturers, supply information that

Columbia

Announces

**The third of a series
of advertisements /**

*2 pages facing
in color
in*

**THE SATURDAY
EVENING POST**

This Advertisement Appears in *THE*

The New

Viva-tonal

COL



Viva-tonal Columbia
Model 810 . . . \$300
(Decorated Brown Mahogany)
Model 800 . . . \$275
(Two-Tone Walnut)



Viva-tonal Columbia
Model 611 . . . \$115
(Decorated Walnut)
Model 601 . . . \$90
(Two-Tone Brown Mahogany)

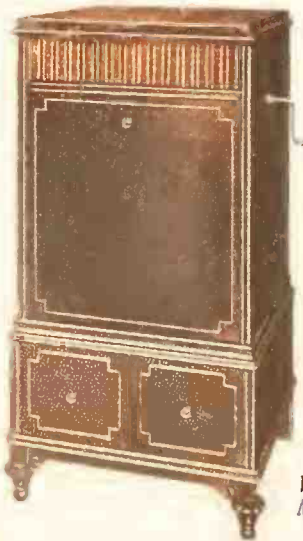

Viva-tonal Columbia
Model 650 . . . \$150
(Rich Brown Walnut)



Viva-tonal Columbia
Model 710 . . . \$175
(Decorated Brown Mahogany)
Model 700 . . . \$160
(Two-Tone Walnut)

Columbia

-like
life
itself

This one finest gift
this Christmas
overshadows all the rest

THE Viva-tonal Columbia is greater than a phonograph—it is the successor to the phonograph. Not only does it do all that any phonograph ever could do, but it vastly increases the entire range and volume of musical and vocal reproduction.

The deepest bass notes, so essential in dance tempo, but formerly not audible in phonograph music, are now accentuated as the composer meant them to be. Great symphonies may be heard with full appreciation of every nuance of orchestral rendition. *Not only* magnificent volume—*not only* startling clarity—*not only* absolute truth—but all the

beauty of all the music of all the world!

All that music is today, the Viva-tonal Columbia is—and it is yours to give—for *their* enjoyment.

Make this supreme test of the merit of your one most important gift—be sure that it is a gift that will *give of itself*.

Never before has it been possible to give such a gift as the Viva-tonal Columbia.

It is a gift that, above all others, *gives of itself*, lavishly, untiringly, affording a lifetime of delight to those who possess it.

The dealer who is to demonstrate the Viva-tonal Columbia to you may be identified by his display of the Columbia trade-mark. If more convenient, write to us for descriptive booklet and let us tell you the name of your nearest Columbia dealer.

Columbia Phonograph Company, 1819 Broadway, New York

COLUMBIA NEW PROCESS RECORDS

Viva-tonal Recording, * * * * the electric records without scratch

The epoch-making electrical process of recording used in Columbia New Process Records is offered to the public by the Columbia Phonograph Company through arrangement with the

Western Electric Company

The public is invited to hear and test such Columbia New Process electrical recordings as the Berlioz *Symphonie Fantastique*, Tchaikovsky's "1812" Overture; Schubert's *Unfinished Symphony* and Beethoven's *Ninth Symphony*, all splendid examples of the amaz-

ing brilliance, smooth surface, volume, and tone-quality now available through the electric recording process. Any Columbia dealer will gladly play these, as well as the latest popular dance and vocal numbers. Look for the familiar Columbia trade mark.

Columbia



Consider each model of the Viva-tonal Columbia as a piece of furniture—force yourself to forget its musical capacity—and you will appreciate its dignity and appropriateness. Study its details and you will find excellence of workmanship happily associated with convenience of design.

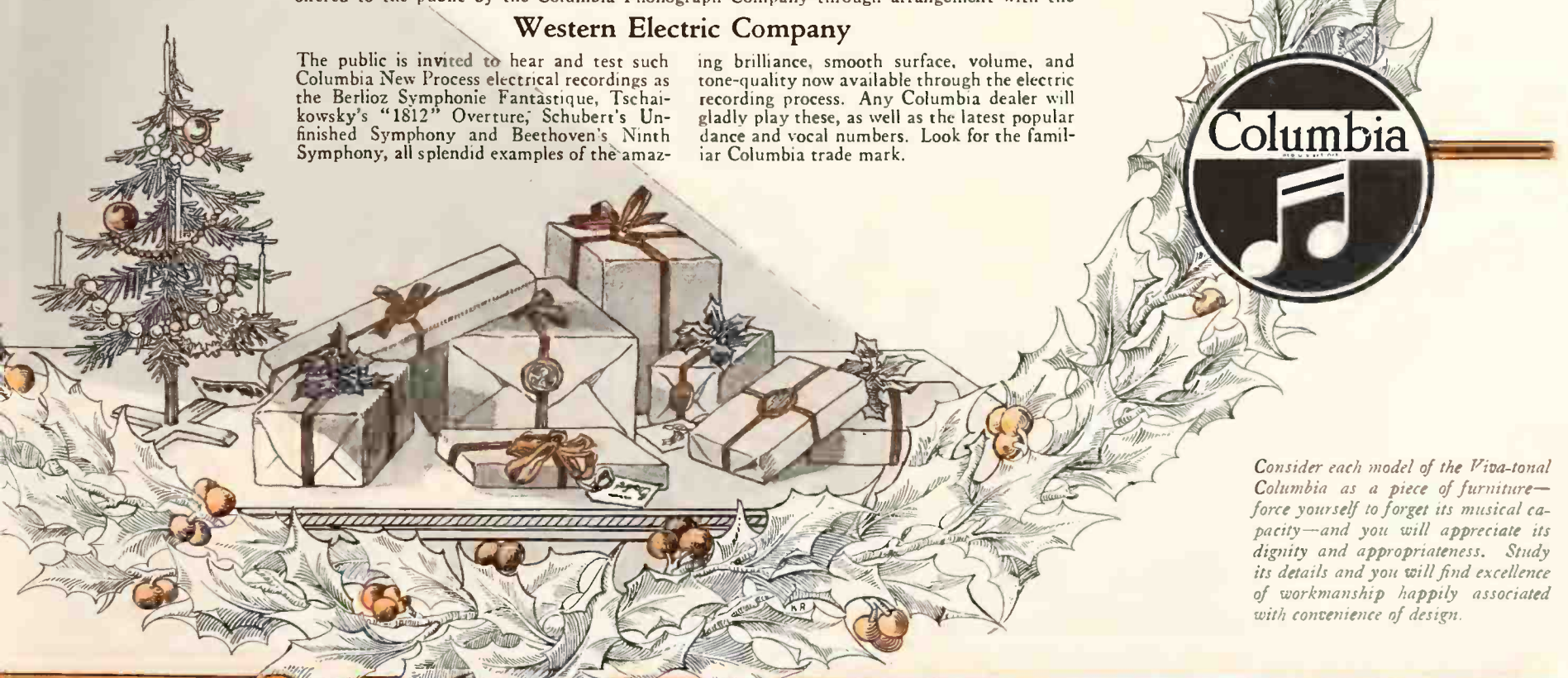

COLUMBIA

THE HOLIDAY SEASON always brings good business to the phonograph and record trade—but there never was a better time to offer the Viva-tonal Columbia and Columbia New Process Records, recorded *the new way* — electrically. The whole country has re-awakened to a complete appreciation of home-music—and the market for Columbia products is ready. Reach out for it. It belongs to YOU.

COLUMBIA PHONOGRAPH COMPANY
1819 Broadway New York



is authentic and the result of careful and expert research, and provide lists of prospective customers that, properly used, are of incalculable value to the would-be exporter, as well as to him who has already had experience in the field.

The well-manned offices that the bureau maintains in the leading trade centers throughout the world keep on file catalogs of American manufactured products, trade publications and other literature designed to give the inquiring foreigner first-hand information of products made in this country that he may desire or can use. These offices also transmit to headquarters information as to market possibilities in their respective districts—information that is at once forwarded to those in the United States to whom it may be expected to be of interest.

This information service is far more elaborate than the average individual appreciates and may be had by the interested manufacturers either entirely without charge or at a cost that may be considered infinitesimal compared with the expense that would attach to similar work carried on under his own direction. Information and advice on export matters come within the province of the expert and manufacturers who contemplate broadening out their distribution to embrace foreign fields would do well to keep in touch with the Government bureaus, or someone equally qualified to give information, rather than to make false moves upon information simply rehashed from Government reports.

Securing general information upon export matters is not a matter of mystery. A letter or two to the Bureau of Foreign and Domestic Commerce in Washington will do the trick.

Closing the Books for Nineteen Twenty-six

WITH the end of the year only a fortnight off, it is possible without calling a halt in the holiday trade to cast up the year's accounts in some measure and find out just how really good 1926 has been to the members of the phonograph and radio trade. It is to be admitted that some of the seemingly optimistic statements issued before the first of the year have been discounted to a greater or less degree by actual occurrences, but taking everything as a whole we are rounding out a year that has been recognized as productive of a staple volume of business, and there is every prospect that the situation will improve materially as months go by.

Talking machine dealers for the most part have been in a peculiar position for most of the year. The public responded nobly to the appeal of the new types of instruments and new records, and the question has been one of obtaining adequate supplies of desirable models rather than that of developing prospects. For the dealers who have worked consistently and intelligently, the business volume has been of quite substantial proportions, and as stocks become increasingly available this volume should grow in like proportion. For the most part it has been a seller's market, which has its good points and its bad ones, and the condition will likely exist for the first part of the new year at least.

In the radio field there has been a noticeable settling down and stabilization, and a lack of the excitement that marked the first few years of the business. It has required more intensive selling on the part of dealers as a rule, but the sales have been worth while and the dealers have had the advantage of being better acquainted

To all our friends in the industry best wishes for a Merry Christmas and a New Year of Prosperity and Happiness.

with the product and its handling, with the result that the profits have been worth while. This is a situation that makes for permanence of the industry.

If Congress manages in some way or another to clear up the broadcasting situation there is every reason to believe that radio will continue to be a distinctly important factor in the business world, for the industry has now found itself.

Nineteen hundred and twenty-six has not been in any sense a boom year, but it has been a most substantial one, and for the retailer who appreciates the dangers of inflation and then deflation the absence of a boom is not to be regretted.

Keeping the Mailing List Alive

A LIVE mailing list is one of the most valuable assets of the talking machine dealer in the building up of a record business of large proportions, for it enables him to keep his prospects and his customers constantly informed regarding the new musical offerings calculated to make them interested in their phonographs. The mailing list, however, is of greatest value only when it is kept constantly up to date, for circular matter sent to the old addresses of those who have moved away or passed on means that much wasted postage and wasted effort.

Checking up on the mailing list at regular intervals is not an embarrassing process if the dealer takes advantage of the offer of the postoffice to do that checking for him at a cost much lower than the same work could be done by the members of his own organization. Elsewhere in *The World* this month it is explained how this official checking can be secured. It is worth earnest consideration on the part of those who do even a fair proportion of their solicitation and selling by mail.

An Outstanding Business Transaction

OF tremendous interest and importance to the entire business world and the talking machine trade in particular was the announcement on December 7 of the sale by President E. R. Johnson, of the Victor Talking Machine Co., of the control of that company to the New York banking firms of Speyer & Co. and J. & W. Seligman, through a deal which when completed will call for the payment of \$40,000,000 or more. Need it be said that the final transfer of control came as a surprise to the industry. Further announcements as to the future policies and plans of the Victor Co. will be awaited eagerly by the industry and especially that large part of it closely affiliated with Victor activities.

National Record Albums

are

Good Albums

Nationally known because they give real satisfaction.

They require less selling effort. Made to contain all makes of disc records including Edison.

Write for our list of 1926 styles and prices

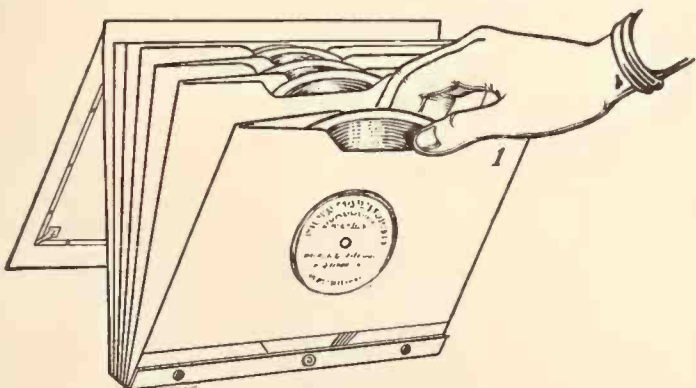

NEW PORTABLE ALBUM

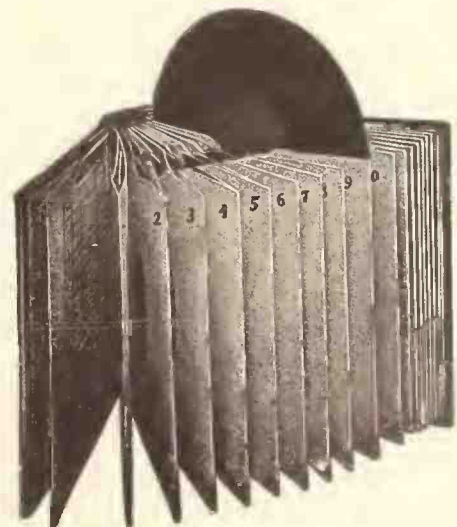

THE PERFECT PLAN

NATIONAL PUBLISHING CO., 239 S. American St., PHILADELPHIA, PA.

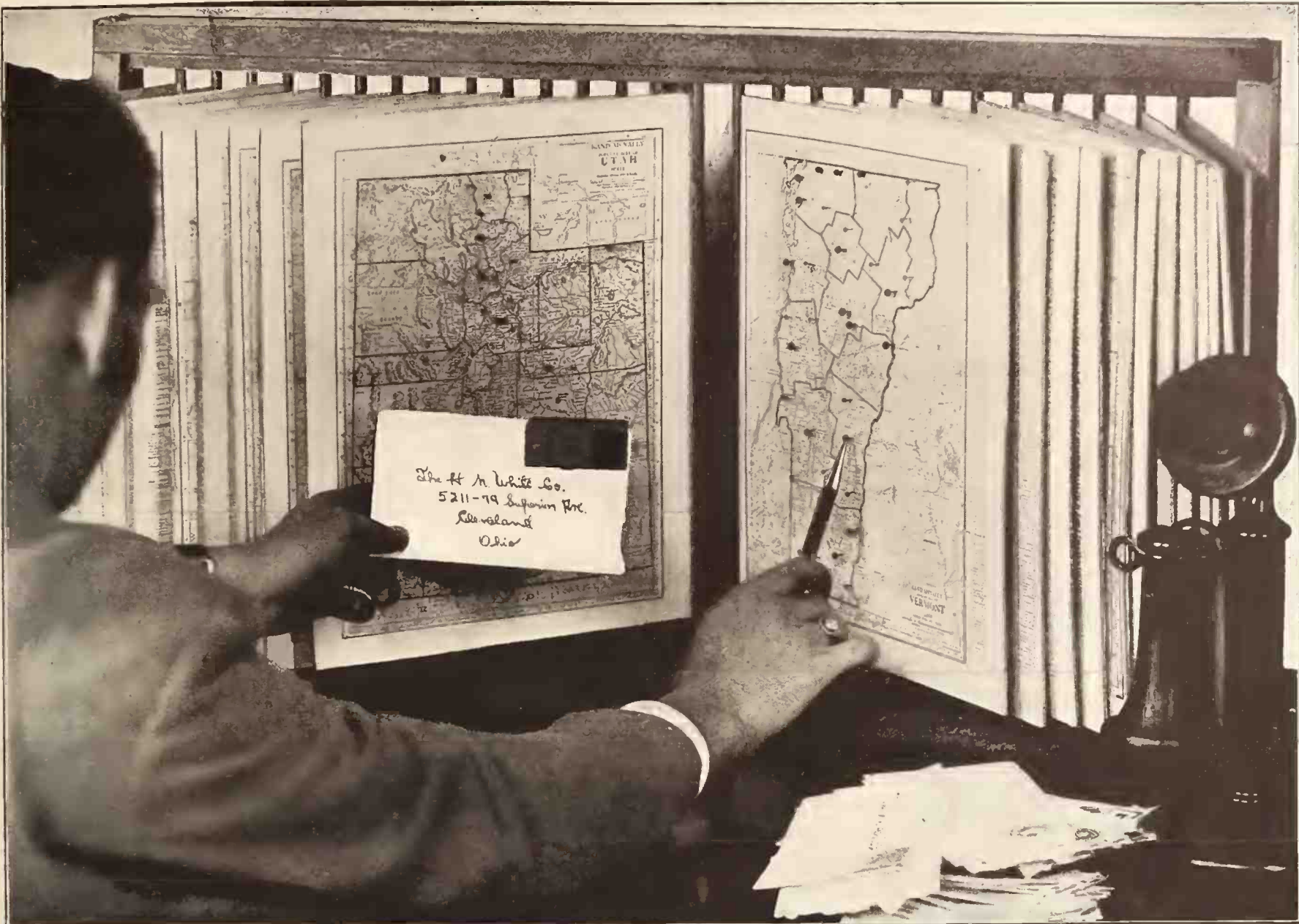

For Your Protection!

KING Dealers Get Every Inquiry

A "KING" dealer contract means just what it says. When we grant an exclusive territory, it is exclusive. Every inquiry from that territory is referred to you. Every lead is given to you promptly.

All this is made certain by the system pictured above. Every letter we receive (except those from our dealers) is checked against our master maps. Signals are attached to the letters showing territory and dealer's name. Then we make sure that that inquiry, or that bit of information, is passed on at once. For time is of importance if the dealer is to realize full benefit from the lead so referred.

Absolute protection, made sure by "King" methods, means more profit for you.

Plus this adequate guarantee of territorial rights, we offer you:

- 1 A thoroughly good line of band instruments and saxophones. You know "King" quality.
- 2 Intensive, persistent advertising. National magazines and "class" publications carry the "King" story to your customers every month.
- 3 Maximum discounts.
- 4 An adequate financing plan for the handling of time-paper.
- 5 Intelligent co-operation. Direct mail campaigns, display material, forceful catalogs, imprinted literature—these are just a part of the "King"-planned co-operative selling service.

Every feature you seek is offered to you in the "King" dealership contract

Many good territories are still open. Each week makes that number less. Our mutual profit suggests a discussion of your territory now. *May we have that opportunity?*

THE H. N. WHITE CO.

5215-82 Superior Avenue
CLEVELAND, OHIO

Makers of

KING
BAND INSTRUMENTS

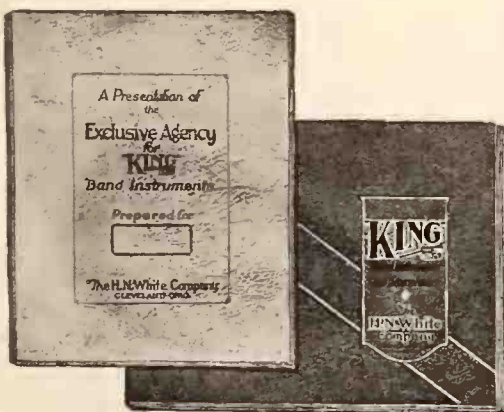

THE H. N. WHITE CO., Makers of King Band Instruments
5215-82 Superior Ave., Cleveland, Ohio

Send your latest catalog and discount sheet along with complete information on the "King" Agency.

Also send information about your plan for financing sales.

Name of Firm.....

Individual.....

Address.....

City..... State.....

Co-operative Ads Score Over Sales Resistance

How G. M. Jensen, Brunswick Branch Manager,
Buffalo, Created Demand by Advertising Drive

[The accompanying article by Eleanor C. Spencer describes the effect of co-operative advertising and brings out the value to retailers of taking advantage of opportunities of tying up with campaigns staged by manufacturers and wholesalers—EDITOR.]

Co-operative advertising participated in by talking machine dealers, wholesalers and manufacturers during the past year has assumed growing importance as a means of sales promotion and building prestige for the dealers and



George M. Jensen

the lines they handle. There is no doubt about it, by combining their efforts the dealers, with the aid of the manufacturer or wholesaler, have been able to present their products to the public in a manner so impressive that sales have been noticeably increased. Many dealers, whose limited means prevent extensive newspaper advertising, in this manner get the benefit of page and double-page spreads in the newspapers at nominal cost. Co-operative advertising is good for the dealer and it is good for the wholesaler and manufacturer. It stimulates business all along the line and it is the type of help that farsighted manufacturers are placing at the disposal of the merchants who handle their lines.

A co-operative campaign that has been markedly successful and which demonstrates the value of this method of sales promotion is that staged by George M. Jensen, manager of the Buffalo branch of the Brunswick Co.

Working on an Advertising Appropriation

Mr. Jensen was allowed so much for factory

advertising. He determined he would elaborate on this advertising, which usually came in one or two-column strips, so in the evenings at home he drew up several layouts for page newspaper advertising, and balanced a dealer tie-up with the factory advertisement. He explained to the dealers the advantage of this opportunity to take part in a page newspaper advertisement, giving them publicity and prestige that could not be gained any other way for so reasonable a price. His campaign was successful from the start. Mr. Jensen was certain of results, and his confidence was transmitted to his dealer patrons, so that the enthusiasm became spread throughout the Brunswick trade of his territory, which covers western New York and northern Pennsylvania.

Immediate Results

The experiment was tried out in Buffalo early in May, shortly after Mr. Jensen was placed in charge of the district, determined to put Brunswick before the public of his territory. Results were immediate. He carried his idea to Niagara Falls, Elmira, Ithaca and Jamestown, and in every instance the dealers were so greatly pleased that the page co-operative advertising of Brunswick dealers in these communities has been established as a permanent institution.

The copy is timely and has bearing on some current news. If a Brunswick artist is appearing in the city the fact is featured in the advertising copy, which emphasizes records. A greater portion of the Summer copy featured Brunswick dance records.

Pleased as Sales Increase

"The dealers of this territory are greatly pleased with results of the co-operative advertising which we have conducted so far," Mr. Jensen said. "It has brought them excellent immediate results. For our distributing office it has been more than satisfactory. The net returns have gone vastly beyond my fondest expectations. I am more fully convinced than ever that the best results can be obtained through teamwork. The development of our page advertising is only the beginning of the most constructive advertising campaign ever conducted by the company.

"The effect of the advertising has been two-fold. First, it has brought more buyers to the dealers, resulting in a greater volume of business through creating a desire to buy in the consumer through the printed word. Second, by encouraging dealers to tie in their activities with national advertising, we are definitely sure of their more effective co-operation in a merchandising way."

Monthly Sales Gains in Slow Season

Proof of results of the Summer campaign

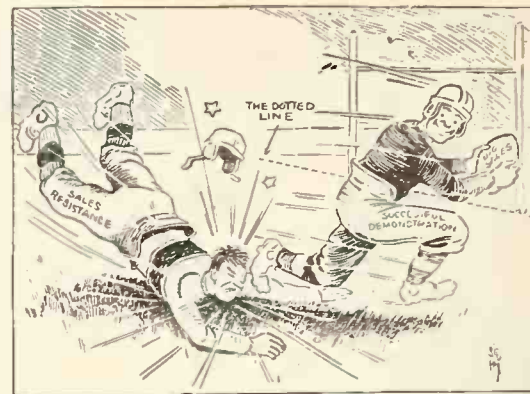

can be found in the following month-to-month comparisons, showing a percentage increase in sales each month of the warm weather season which ordinarily show a decline. May sales showed an increase of 9.3 per cent over those of April; June increase over May was 43 per cent; July increase over June, 7.7 per cent; August increase over July, 12.1 per cent, and September over August, 30 per cent. October sales showed the greatest increase compared with September, which obviously is explained through the fact that the Panatrope Model P-1, operating on a twenty-five-cycle electric current, was released in Buffalo during the forepart of October. This electric current is prevalent in the residential sections of the city and scores of buyers were waiting for this instrument to be placed on the market. They were placed in homes as rapidly as they were shipped to the city, and the October increase in net profits went towering over any percentage of the preceding five months.

Broadcast Brunswick Records

Mr. Jensen has not confined his efforts only to newspaper advertising in exploiting the Brunswick instrument and records. He has arranged with Jamestown's leading broadcasting station to set aside a Brunswick dinner hour each Thursday, when the new Brunswick releases are played on the Panatrope, which was loaned the station in exchange for its courtesy to the distributor. In announcing the new releases the names of the Brunswick dealers in the city are given as sponsors of the program. The dealers and Mr. Jensen all agree that this has been exceptionally effective in creating new Brunswick record customers as well as stimulating old customers to buy new releases. The broadcasting station has received many letters from listeners-in commending it for allowing them to hear these new recordings. When a Brunswick artist appears in Jamestown, almost without exception he gives a concert or recital at the broadcasting station, and comparisons are made over the radio with his record on the Panatrope. These tests always bring results and there are often requests for repeat performances.

Setting an Example

Officials of the Brunswick Co. declare that Mr. Jensen is setting an example for many phonograph distributors. His enthusiasm, intelligent effort and hard work have won the admiration and commendation of his employers who have suggested some of Mr. Jensen's methods of advertising and exploitation to other Brunswick men throughout the country.

Illustration at top of page through courtesy of "Brunswick Pace-Maker."

STARR PIANOS STARR PHONOGRAPHS

GENNETT RECORDS

Represent the Highest Attainment in Musical Worth

The STARR PIANO COMPANY

Established 1872

Richmond, Indiana

\$1000⁰⁰ for a Name

Nothing to buy. No obligation of any kind.

Send in one or as many suggestions as you desire. Here is your chance to win \$1000

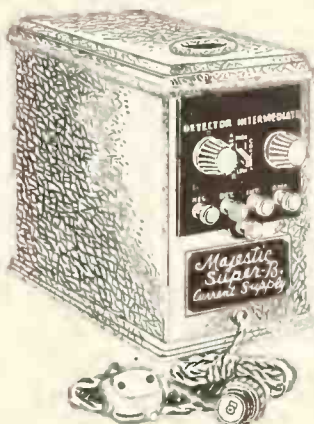

Our product is known as Majestic "B" Current supply with a slogan, "delivers pure, direct current from your light socket." We believe the name and slogan can be improved. A cash prize of \$1000.00 will be paid the person sending us the best suggestions for a name and slogan—with a short letter giving reasons for selection. Duplicate prize awarded in case of tie.

Hints to Help You

Keep the name Majestic. Originate a new and better word or phrase for "B Current Supply," also an appropriate slogan.

The Majestic _____? vastly improves radio reception, contains no acids or liquids and voltage can be accurately adjusted to meet varying conditions in every city and on any set. Some of its advantages should be brought out in the new name and slogan you suggest.

If you have not already heard a radio set using a "Majestic" go to your dealer for a demonstration. It will be a new experience for you in radio reception. It may also give you the inspiration for a name and slogan that will bring you \$1000.00. Dealer will be glad to show you the Majestic and do everything he can to help you win prize.

Contest closes at midnight January 29, 1927. Award of judges will be published in this paper about February 15th. Address all letters to Contest Manager, care of

GRIGSBY - GRUNOW - HINDS - CO
4584 ARMITAGE AVE,
CHICAGO - ILL

Contest Manager, care of Grigsby-Grunow-Hinds Co.
 4584 Armitage Avenue, Chicago, Illinois

I submit for name. MAJESTIC _____
 For Slogan _____
 Name _____ Address _____
[Use this form or one similar]

MUSIC Dealers

At the left appears the first of a series of advertisements that will run in over fifty Metropolitan newspapers each week beginning January 2, 1927, to January 29, 1927.

The prize contest will focus the attention of millions of radio fans on our product and possibly you dealers may also be interested in suggesting a name and a slogan.

This contest will doubtless mean a tremendous public interest in our Majestic "B" Current Supply. Display the device in your show window and attract attention to your store. You will profit from increased sales and the prestige of an article that gives entire satisfaction.



If you have not secured from your jobber counter display cards and window streamers, write or telegraph us.

GRIGSBY-GRUNOW-HINDS CO.

4558 Armitage Avenue

Chicago, Illinois

Goggan's Idea Exchange Plan Aids Selling

Increases Efficiency of the Sales Organization by Discussions of Problems and Exchange of Ideas at Regular Meetings of Staff

By B. C. Reber

After all, the ultimate success of a product lies in its distribution to the consumer. A manufacturer may search to the far corners of the earth to obtain the finest material for his product. The jobber may use every effort within his means to give better deliveries and better terms. The retailer may have a fine store, and he may trim his windows in the most attractive manner while at the same time he ties up his displays with effective advertising. But unless the salesmen have the knowledge and ability to work effectively the money spent to get people into the store will be largely wasted.

A short time ago a business bureau made a survey among retail salesmen to determine the weak points in this part of merchandising. When all the reports had been turned in, it was found that inattention and lack of initiative were almost wholly the cause of less volume among retail stores.

Be that as it may, there are quite a number of retail merchants who have not waited for surveys to disclose their faults. They have studied their individual problems and have applied methods to remedy faults. These merchants stand out from the general average as the silver dollar in this country stands apart from the franc. And among these merchants may be classed the store of Thos. Goggan & Bro., San Antonio, Tex. W. Edgar Parker, manager of the radio and phonograph departments, tells how they have eliminated these faults in their sales forces and shows how the business has been materially benefited.

Exchange of Ideas Helps Salesmen

"Probably the greatest help in retail selling," Mr. Parker explained, "is in the exchange of ideas. No one person will look at a problem from the same angle that another will see it; and it is because of this fact that new methods are brought out and new means created for selling more merchandise and rendering a greater service to the customer.

"We have what we consider as good a sales

force as can be brought together. I have used great care in selecting the various employes in our talking machine department and I believe that I can positively say that they will rank well with any other sales force in the country.

"We have taken up the task of training this group of people to become expert sales people.

In the accompanying article W. Edgar Parker, manager of the talking machine and radio department of Thos. Goggan & Bro., San Antonio, Tex., tells how sales meetings are conducted and how the efficiency of the salesmen has been increased as a result. There is food for thought in this article for every progressive talking machine dealer.

We have selected them because of their personality, their neat appearance, their references and their general impressions. We hold regular sales meetings in which we conduct sales schools. We will take one item like a new record or a package of needles and give one or more meetings to that individual item until we have conquered it. If it is a new record that has just arrived, we endeavor to find out why such a record has been made, who wrote the musical score and whose orchestra or band plays the music.

"If it is from a musical comedy we learn of what play it is a part and get a brief summary of the play itself so we can better appreciate and understand the music and the words which accompany it. Each record of this kind is thor-

oughly discussed; and there is not a person in the department who is in a position to handle sales but who can talk intelligently on any record we have in stock.

"We take the phonograph and analyze it. To us it is more than a cabinet with a spring, a motor and a peg for holding a round disc. It is an instrument of entertainment. One which will educate as it entertains. It is something which will while away a weary evening. It can be used by both old and young with equal enjoyment. It has a long life, and the initial investment can be spread out so that before it is of no further use the actual cost will amount to less than a cent a day. That's a strong selling point.

"Then we have meetings when we discuss the points in which we are weak. If one of the salesmen goes out to call on a prospect for a phonograph and fails to make the sale we may have him get up and tell us what he said. Then we will criticize his sales canvass and determine what should have been done. Or, if he has made a good sale, we may have him tell how he did it so others may benefit.

Higher-Priced Units of Sale

"We have shown a constant increase in business, and we are gradually going into the better grade of merchandise. By that I mean that the majority of our sales are now in the better machines, rather than a large volume made up of sales of cheaper models. We teach the customer to appreciate the best. We point out the pride in possessing a machine that ranks with the best that can be had. We emphasize the value of having a machine that will interpret the tone quality and reproduce it just as the artists would give it in person.

"We teach the value of music in the home—the educational value to the growing children. We point out the simplicity of operation of a phonograph and the large variety of entertainment that may be enjoyed on one of these machines. We stress the importance of some kind of entertainment in every household. We show how more happiness and contentment is to be found in homes with music.

"Then we stress the economy of the phonograph. Here is a machine that provides a great variety of entertainment. You do not have to hire some one to play for you. You do not have to spend a lot of money and time in learning how to play. You can listen to the golden voice of Caruso. Then you can sway to the tunes of a dance orchestra. Tired of both of these you can hear a snappy banjo solo, or some novelty record. The range of entertainment is almost unlimited.

"I believe one of the first essentials of salesmanship is to know what you are going to sell and to believe in it. Unless you can go to a customer honestly believing that you are representing the very best phonograph or record that can be made, you will never be able to sell successfully. One of the foundations of salesmanship is the faith you have in your merchandise, and unless a salesman has that it is better for both him and his house to part company.

Co-operation as Factor in Selling

"Co-operation among the employes is a great thing in building up sales and maintaining harmony. If an employe comes to me with an idea that he thinks is a good one, I owe it to my firm to give it most careful consideration. If the idea is a good one, it should be adopted and he should be given proper credit. If it is one which is not feasible, this should be carefully explained to him. Then he should be thanked for his co-operation and interest."



More Than a Million Sales for WESTON Radio Plug

Now comes the Weston Convertible "Pin-Jack" Voltmeter!

The Weston Convertible "Pin-Jack" Voltmeter is now ready to make its sales record and advertising is appearing during the radio season in the SATURDAY EVENING POST, reaching millions of potential customers who already know the quality of Weston products. ¶This "Pin-Jack" Voltmeter and High Range Stand is the most practical double-purpose voltmeter ever offered to the radio public. It measures both filament and battery voltages at the cost of one instrument,—insures intelligent radio operation, set performance, set satisfaction, set economy and profits for the dealer.

Write or wire at once for full information

Weston Electrical Instrument Corporation
190 Weston Avenue, Newark, N. J.

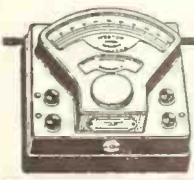

STANDARD THE WORLD OVER
WESTON
Pioneers since 1888



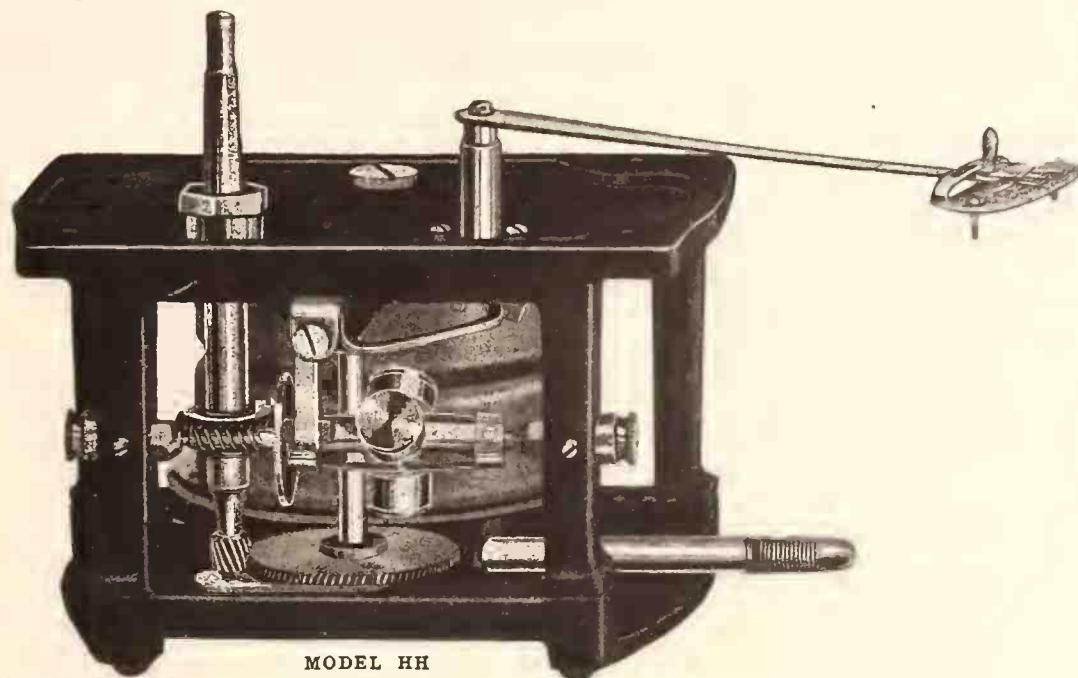

MODEL HH

Model HH, Double Spring Silent Motor, guaranteed to play five 10-inch records, absolutely noiseless in running and winding.

COMING—We will shortly announce Model KK, Double Spring Silent Motor, to play about four records. Same in every respect as Model HH, but smaller size.

The SILENT MOTOR FAMILY

Read what the Carryola Company of America, the largest manufacturer of portable phonographs in the world, says about The Silent Motor:

"The Silent Motor, in our humble opinion, is the best motor made, bar none. And it's quiet. You can't hear it turn."

"The Silent Motor has many special, strong features. It was selected for the Carryola Line because of its remarkably steady performance and freedom from 'grief.'"

"It is unconditionally guaranteed by us against defective workmanship or materials."

Silent Motor Corporation

HERMAN SEGAL, President

321-323-325 Dean Street

Brooklyn, N. Y.

Victor Co. Issues Fine Catalog for Consumers

Complete Line Made by the Victor Co. Is Illustrated and Described in Artistic Booklet Designed for Consumer Distribution

"The New Orthophonic Victrola, Electrolas and Radiola Combinations," is the title of an unusually attractive twenty-four-page catalog that is being distributed by the Victor Talking Machine Co., Camden, N. J. The complete line of instruments manufactured by the Victor Co. is illustrated in a most pleasing way.

The catalog opens with an introduction outlining briefly the merits of the new instruments and records. It is also pointed out that in choosing an instrument the quality of music, perfection of reproduction and entertainment value must be considered. The Victor Co. emphasizes other qualities that must be considered, namely, "Design," "Quality of Material," "Construction," "Wood Finishes" and

"Equipment—Ease of Operation." Considerable space is given to a description of the Orthophonic tone chamber, following which are illustrations in color of the various instruments.

The catalog really is in four sections—First, the Orthophonic Victrola line; second, the Electrola; third, Victrola-Radiola combinations, and fourth, portables. Accompanying these illustrations is a complete description of the instruments, including list prices.

The catalog is a fine piece of work, printed on buff-colored paper. It is designed exclusively for consumer distribution and as a sales promotion aid it should be of real value to retailers. The catalog will undoubtedly prove of great benefit in bringing to the attention of the public in an appealing and forceful manner the merits of the new instruments, paving the way for later follow-up by dealers.

The Victor Co. is releasing a record made by Benito Mussolini, Premier of Italy, bearing his message to "The American People and to the Italians in America."

H. R. Fletcher Appointed Algonquin Sales Director

Making Headquarters at General Offices of Company—Has Had Wide Experience in Sales Field in Various Industries

The appointment of Harold R. Fletcher as director of sales of the Algonquin Electric Co., Inc., New York, recently announced by Leo Potter, president of the company, has been received with considerable interest in the music-radio industry. The Algonquin Electric Co. recently acquired the trade name Thermiodyne



H. R. Fletcher

and is manufacturing a new Thermiodyne Fifteenth Century Period Chest model in its factory at Poughkeepsie, N. Y.

Mr. Fletcher, who is one of the best-known sales executives in this field, comes to the Algonquin organization from the AmSCO Products Co., where he was director of sales. His New York associations date from 1908, when he traveled for the W. E. Pruden Hardware Co. In 1911 he entered the automotive industry as distributor of Hudson cars and Stewart trucks, later becoming the general sales manager for the latter organization. His automobile activities assumed wider scope when he became vice-president and manager of the C. T. Silver Co., Eastern distributor of Overland and Willys Knight cars and later manager for the Stutz Motor Co.

Mr. Fletcher will make his headquarters at the general offices of the Algonquin Electric Co. in New York, where he is busily engaged in welding together an efficient sales and distributing organization.

Tracy Wells Co. Distributes Kellogg Radio in Columbus

R. K. Smith, sales manager of the Kellogg Switchboard & Supply Co., Chicago, recently announced the appointment of the Tracy Wells Co., Columbus, O., as a distributor of Kellogg radio products. The Wells Co. is a large and well-known general merchandise house, which will serve as its territory thirty-two counties in Ohio and eight counties in Indiana.

Death of August Smith

August Smith, who for many years had been superintendent in the record making department of the Victor Talking Machine Co., Camden, N. J., and an employe since the organization of the company, expired suddenly from a heart attack, on November 30, at his home, 100 East Madison avenue, Hollingswood, N. J. The lamentable thing about the passing of Mr. Smith is the fact that only three weeks ago he was retired on a pension by the Victor Co. Mr. Smith, who was sixty years of age, is survived by his widow and daughter.

How is Your Business?

"September has been a record-breaking month and if the rest of the year keeps up like this month has, we will certainly set some new records here in this Department. And Buescher True Tone instruments are, of course, the bulk of our sales."

Here is an excerpt from another letter recently received from a music dealer who sees the value of the Buescher Franchise.

The Public has discovered for itself that Buescher Instruments are best. And Music Dealers are finding out that the Public *will* buy what it wants. There is no dull season for the dealer who has what the public wants to buy.

It may be that your territory is still open. At least it would be worth your while to inquire. It may pay you to investigate the Buescher Proposition.

Address:

Buescher Band Instrument Co.

Wholesale Department

ELKHART, INDIANA

BUESCHER
True Tone
Band and Orchestra
INSTRUMENTS

“**W**E are the music-makers,
And we are the dreamers of dreams,
Wandering by lone sea-breakers,
And sitting by desolate streams;
World-losers and world-forsakers,
On whom the pale moon gleams:
Yet we are the movers and shakers
Of the world forever, it seems.

With wonderful deathless ditties
We build up the world's great cities,
And out of a fabulous story
We fashion an empire's glory:
One man with a dream, at pleasure,
Shall go forth and conquer a crown;
And three with a new song's measure
Can trample an empire down.

We, in the ages lying
In the buried past of the earth,
Built Nineveh with our sighing,
And Babel itself with our mirth;
And o'erthrew them with prophesying
To the old of the new world's worth;
For each age is a dream that is dying,
Or one that is coming to birth.”

Ode by Arthur O'Shaughnessy

CHRISTMAS 1926



"Glory to God in the highest, and



th peace, good will toward men”

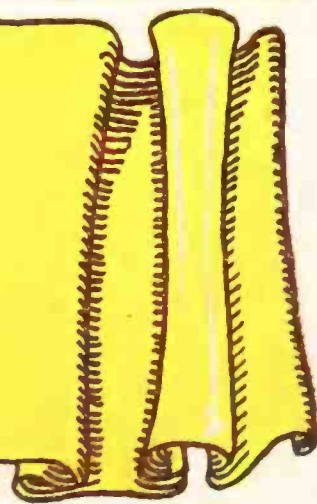

For the New Year—1927



THERE is no greater pleasure . . .
than to wish our friends happiness
during the New Year, that is to come,
and greater prosperity And to
acknowledge the splendid spirit they
have manifested toward us during this
year.

OKEH PHONOGRAPH CORPORATION

GENERAL PHONOGRAPH CORPORATION

A handwritten signature in cursive script, appearing to read "W. H. Murray", followed by a long horizontal line extending to the right.

President

Consolidated Co., Baltimore, Utilizing Big Business Methods to Sell Brunswick

First Public Utility Concern to Feature Comprehensive Line of Phonographs and Combination Instruments Plans a Strong Campaign of Sales Promotion

BALTIMORE, Md., December 7.—The Consolidated Gas & Electric Light & Power Co., of this city, which recently added the complete line of Brunswick Panatropes, electric phonographs and records, is placing a strong merchandising campaign behind these products. This, by the



Ben Bernie and His Orchestra in Baltimore way, is the first public utilities organization in any large city to merchandise musical instruments of this kind. Because of the fact that the policy of the Consolidated Gas & Electric Light & Power Co. provides that only commodities which consume electricity or gas in some way may be sold, only those instruments that are electrical products will be handled. The entire stock, of course, will consist of Brunswick phonographs equipped with electric motors, as well as the Panatrope line. Brunswick records come under the electric classification, because they are recorded by an electric light ray method.

The concern has one of the finest buildings in Baltimore, in the heart of one of the busiest

shopping districts, and the musical instrument department has been lavishly decorated and will be second to none in the entire State from the standpoint of display facilities. A large force of outside men is employed, fifteen of whom operate from the department handling the Brunswick product. Ten experienced men comprise the inside sales force. Salesmen are carefully selected; each man must pass through an especially prepared course and intelligence test. In addition, the salesmen have subscribed to the Brunswick Panatrope salesmanship course in order to more intelligently market the new product. Just about the time the Brunswick line was added preparations were

being completed for an exhibition of the "Lady of Light," which features a wax figure in a giant seashell that can be colored in various ways through an ingenious electric light arrangement. This exhibit and contest lasts for thirty days and it is expected that from seventy-five to one hundred thousand people will visit the department. Of course, all of these people will visit the Brunswick exhibit. A complete display of the instruments has been arranged around the "Lady of Light" and during the entire exhibit Panatrope demonstrations will be made. Recently Ben Bernie and his Brunswick Record Orchestra appeared at the department for three consecutive days, entertaining with their music thousands of visitors. These few points indicate that this company is planning to utilize big business methods in merchandising the Brunswick line, and the methods employed provide food for thought for dealers who hesitate to really get behind their talking machine lines.

Harry Reser, Columbia Star, Makes 2000th Record

Harry Reser, director of the noted Clicquot Club Eskimos, exclusive Columbia Phonograph Co. recording artists, is celebrating the completion of his 2000th record. In less than five years that Harry Reser has been in New York, he has established himself as one of the foremost banjoists of America. As leader of the Eskimos and other dance organizations he has made a number of dance records that have won great favor with the public. The two thousandth record was made by Reser a short time ago at the recording laboratory of the Columbia Phonograph Co. in New York City.

I. Weatherman has opened a complete music store in the Skelton Building, Heber Springs, Ark. Standard lines are handled.

Col. Mapes to Re-enter Radio Manufacturing Field

Following the dissolution of Radio Center, Inc., Col. S. Herbert Mapes, widely known radio executive, has announced the completion of plans which involve his re-entry into the radio manufacturing field. Col. Mapes has established offices in New York, and expects soon to begin the distribution of a power receiving set, built to operate from either alternating or direct current, at a modest price for such equipment. Details will be given to the trade at an early date, it is announced.

Col. Mapes also states that he has allied himself with the production of refrigeration units for the home and a household oil-burning heat system at popular prices. It is said that Col. Mapes will be president of the holding company controlling these manufacturing activities.

For Christmas--
give happiness that
only ORIOLE can bring!

DEALERS who are wise reap Christmas profits from the better merchandise. With the dependable Oriole Receivers you have a line of business stimulators that will speed up turn-over and enrich your profit while giving lasting joy and satisfaction to both the giver and the recipient. Oriole Receivers with the Trinum Circuit are positively amazing in performance--and they stay sold.

Sales Department
 The Zinke Co.
 1323 S. Michigan Ave.,
 Chicago, Ill.

Manufactured by
 W-K Electric Co.
 Kenosha, Wis.

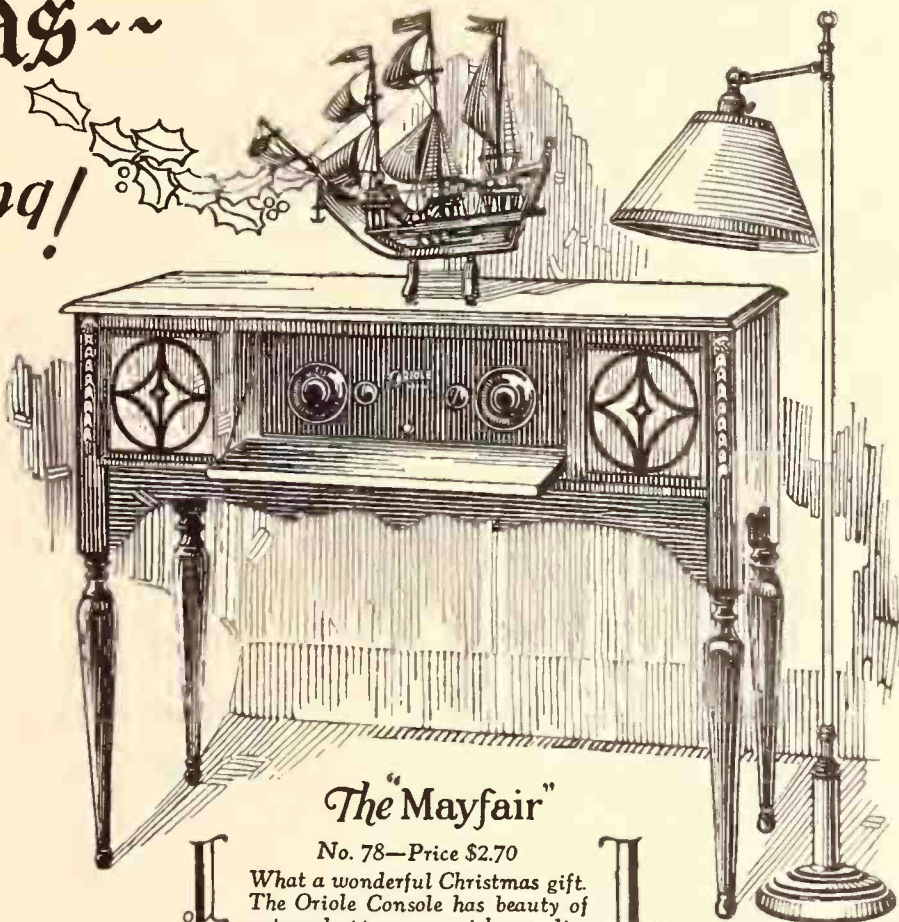

The "Mayfair"

No. 78—Price \$2.70

What a wonderful Christmas gift. The Oriole Console has beauty of outward appearance, richness, dignity! And it brings true entertainment. Full rounded tones--two loud speakers give maximum tonal range, fully 6 1-2 octaves.

ORIOLE *Radio Receivers*

Money-Making Suggestions for Ambitious Merchants

Three years ago the talking machine department of a music store located in a business section of New York City, on a street used daily by many thousands of pedestrians of practically every nationality, did a gross business annually of approximately \$15,000. This figure was unsatisfactory to the proprietor because of the high overhead, and he contemplated doing away with the department. A new manager was secured and he was given the position with the understanding that he had a year to meet a certain figure that was regarded by the owner as satisfactory. The new manager studied the situation and decided that the biggest asset of the store was being overlooked, as not a single foreign language record was in stock—the domestic and classical recordings comprising the catalog—despite the fact that immediately bordering the street upon which the store was located there were settlements of Russians, Italians, Germans, Spanish and other foreign-born and foreign-language-speaking peoples, and the passers-by were, to a great extent, foreign-born. Catering to this class of trade built the store's business within a few months to \$7,000 and \$8,000 monthly, and at the present time a monthly business of \$25,000 is not unusual. A large percentage of this business consists of foreign language record sales. The yearly gross sales for the year of 1925, talking machines, records and combination of talking machines and radio receivers, despite the fact that there was a shortage of instruments for the last two months, were in excess of \$175,000. The remarkable growth of this store in such a short time is undoubtedly unusual, but it emphasizes the importance of careful studying of the retail market.

\$ \$ \$ \$ \$ \$ \$

With the present-day music dealer representing one or more lines of talking machines, anywhere from three to ten lines of radio apparatus, and a miscellany of lines of musical merchandise and band instruments, to say nothing of other items, the average mail brings a vast amount of literature from various manufacturers and jobbers all designed to help the merchant sell. Some of this literature fulfills the end for which it was designed, but it is also true that a great part of it is superfluous and many dealers after a time consign the contents of these envelopes to the wastebaskets without even a glance. It is unfortunate that this happens, for in many instances the manufacturers send information of a decidedly helpful nature, compiled by experts, and the application of the policies urged in the sales promotion aids would build profits. An illustration of such a message is the following bulletin recently sent to deal-

ers by the Atwater Kent Mfg. Co., treating of the important subject of trade-ins. It reads:

"Many dealers strive earnestly to make a perfect sale, and when that sale is made they 'let down' on the question of 'trade-in' terms. It is more than likely that if the same effort was exerted to avoid accepting the 'trade-in' as was used in making the sale the dealer would win out.

"How? There are many ways and the prospect's position in life should indicate one of these ways. If he is, by chance, a manufacturer, large or small, it would pay to point out to him that his old radio would be useful in his office for keeping him informed on market information or business news. The same line of reasoning applies to the manufacturer's agent or sales representative who maintains an office.

"Should he be a produce commission merchant, his old radio would be useful for weather information. This latter argument should appeal to men interested in water or long-distance trucking transportation. Contractors interested in outdoor construction and even men interested in amusement parks should respond to this appeal. Failing in finding a business appeal for using the old radio, there is one last stand that will register a victory for the dealer in a large percentage of cases.

"Here it is as used: 'Surely,' says the dealer, 'your old radio while unfit for your home is more valuable to you as a gift to someone dependent on you or in whom you are interested than it would be as a resale or second-hand article.' That may be the last stand, but, effectively used, it at least breaks down the prospect on the question of how much he might be allowed on his obsolete set."

\$ \$ \$ \$ \$ \$ \$

Several times there have appeared in the columns of The World instances telling of the success a certain New York dealer has had in selling records, with a great percentage of his sales being of the better type of music despite the fact that the location of the store is not conducive to such trade. The store is on the East Side of New York on a street given over to shops handling mainly a low grade of merchandise. However, this dealer has, through a number of methods, built up a clientele of patrons who go out of the way to patronize his store. Within the past few months a branch store of this establishment was opened and it soon became apparent that the same high quality of merchandise composed most of the volume of record sales. Other dealers in better locations and with the same line of merchandise do not sell a fraction of the records disposed of by these stores. What's the answer? This dealer and his branch manager both know and love music and take every opportunity of making themselves better acquainted with new compositions and with the artists who make the records, so that both can talk intelligently to prospective purchasers. On the occasion of the opening of the Sunday night popular concerts at the Metropolitan Opera House, New York, the writer met both the dealer and his branch manager entering the opera house, and the dealer referred to the fact that three recording artists would be heard in concert. The branch manager

also mentioned that in the afternoon he had heard the Philharmonic Orchestra play. The moral—? a tailor must know cloth, a plumber pipes, why shouldn't a music dealer know something of music?

\$ \$ \$ \$ \$ \$ \$

A radio dealer situated in a residential section of an Eastern city does the greater part of his floor selling in the evening and spends the day in canvassing and in attending to service calls. He found that it was unnecessary to employ a clerk or salesman during the day because of the very few calls which he received from prospective customers or shoppers. However, in order that no one desiring service on a radio set should be disappointed he has attached to the door of the store a small pad of paper with a pencil attached, so that visitors to the store, finding no one present to give them attention, can write whatever message they wish and it will be attended to at the time of the proprietor's return. This simple plan has resulted in this dealer's retaining many service customers, for people who desire service, visiting the shop and finding it closed, would wander on to the next shop, but when it is possible to leave their name and address and to state what they wish done, they write their message and await his convenience.

\$ \$ \$ \$ \$ \$ \$

With reference to records it would seem that dealers and their sales staffs might pay a little more attention to this section of the business to be in line with the larger manufacturers of discs, who for the past few months have been giving this end of the talking machine business more and more attention in their advertising space in the newspapers and other advertising mediums. As a suggestion, would it not prove profitable for the record sales staff to read each morning in the newspapers the reviews of the openings of all musical shows and the music critics' reports of the operas and concerts, in order that they may learn what selections proved the "hits" of new musical comedies, and what selections recording artists are singing or playing on the operatic stage or on the concert platform? It is obvious that the record salesman who can talk intelligently to a customer about the latest releases from the current musical productions, or converse on artists and their latest successes, has a greater chance of building up sales than the clerk who must refer to a catalog for his talking points. It is not possible for the sales staffs to visit each such production to attain this knowledge nor is it necessary, but it is possible to gain sufficient knowledge from a study of the newspaper reports to talk interestingly about the artists and records. The plan costs nothing and requires no great effort and is surely worthy of consideration.

The Emerson Radval Corp., New York, has been incorporated at Albany with a capital stock of \$150,000. S. Randel is the incorporator.

TALKING MACHINE WORKS

HERMANN THORENS

Ste. Croix, Switzerland

announces the establishment of its

NEW YORK OFFICE

at

450 FOURTH AVENUE, 11th floor
NEW YORK, N. Y.



The New Balkite Charger

MODEL J. Has two charging rates. A low trickle charge rate and a high rate for rapid charging and heavy duty use. Can thus be used either as a trickle or as a high rate charger and combines their advantages. Noiseless. Large water capacity. Visible electrolyte level. Rates: with 6-volt battery, 2.5 and .5 amperes; with 4-volt battery, .8 and .2 amperes. Special model for 25-40 cycles with 1.5 amperes high rate. Price \$19.50. West of Rockies \$20. (In Canada \$27.50.)



Balkite Trickle Charger

MODEL K. With 6-volt "A" batteries can be left on continuous or trickle charge, thus automatically keeping the battery at full power. Converts the "A" battery into a light socket "A" power supply. With 4-volt batteries can be used as an intermittent charger. Or as a trickle charger if a resistance is added. Charging rate about .5 ampere. Over 200,000 in use. Price \$10. West of Rockies \$10.50. (In Canada, \$15.)



Three New Balkite "B's"

Balkite "B" eliminates "B" batteries and supplies "B" current from the light socket. Noiseless. Permanent. Employs no tubes and requires no replacements. Three new models. The new popular priced Balkite "B"-W at \$27.50 for sets of 5 tubes or less requiring 67 to 90 volts. Balkite "B"-X, for sets of 8 tubes or less; capacity 30 milliamperes at 135 volts—\$42. Balkite "B"-Y, for any radio set; capacity 40 milliamperes at 150 volts—\$69. (In Canada "B"-W \$39; "B"-X \$59.50; "B"-Y \$96.)



Balkite Combination

When connected to the "A" battery this new Balkite Combination Radio Unit supplies automatic power to both "A" and "B" circuits. Controlled by the filament switch on your set. Entirely automatic in operation. Can be put either near the set or in a remote location. Will serve any set now using either 4 or 6-volt "A" batteries and requiring not more than 30 milliamperes at 135 volts of "B" current—practically all sets of up to 8 tubes. Price \$59.50. (In Canada \$83.)

All Balkite Radio Power Units operate from 110-120 volt AC current with models for both 60 and 50 cycles. The new Balkite Charger is also made in a special model for 25-40 cycles.

Permanent pieces of equipment— *in this Balkite feature* lies your profit

To tell the difference between Balkite and any other device does not take very thorough examination. You can tell the difference the minute you look at a Balkite Unit. The difference is even more obvious when you pick up the unit and feel it. *Balkite Radio Power Units are permanent pieces of equipment, made to last.*

The evident scrupulous care that goes into the manufacture of every Balkite Unit is not altruism on our part. It is based on the conviction that to be permanently successful the products of any manufacturer must represent honest manufacturing value. In the long run the public will not accept less.

This scrupulous care is also part of our belief that for a manufacturer to be permanently successful everyone connected with the sale of his product must make a legitimate profit out of it. And by legitimate profit we mean more than the temporary profit made out of each sale. We mean that the manufacturer must take every precaution that the profit of the trade is not eaten up by service cost.

Not only does Balkite give you the greatest volume, but the profit you make on your sales is clean. Once sold, Balkite Radio Power Units stay sold. They don't come back. Get behind Balkite now, and make the maximum profit out of the demand for light socket radio power.

FANSTEEL PRODUCTS COMPANY, INC., North Chicago, Ill.

FANSTEEL
Balkite
Radio Power Units

Stress Radio Service,

By W. B. Stoddard

Not Price, Say Lyon & Healy

The radio department of Lyon & Healy, Chicago, is one of the finest in the city. On the main floor there is a large section, with sales and display space, and ample facilities for a varied assortment of accessories. If a customer likes a set and wishes to hear it demonstrated he is taken to the fourth floor, where there are numerous small rooms in which this can be done without the distractions encountered on the busy main floor. Lyon & Healy were the first musical instrument house to introduce a radio department. This was in the Summer of 1922 when there was only one broadcasting station in Chicago and very little was known about the new form of entertainment. They took it up carefully and cautiously. Said the manager of the department:

"We made exacting tests over long periods of time. We were months assembling the stock of merchandise in order that we could give assurance to our patrons that anything they purchased from us would give satisfaction.

Using Mail Advertising to Good Purpose

"Direct-mail advertising has been used with excellent results in our radio department. Three sets of circulars are sent, ten days apart, to our regular mailing list, which consists of the names of those who have purchased Victrolas from us. These circulars are in the form of folders, with a perforated postcard attached which can be torn off and used by the customer for mailing purposes. There is a place for the name and address. The days of the week are enumerated as well as the hours from 2 to 9 p. m., which the customer can check off when requesting a demonstration. A corps of outside salesmen is employed on commission. These men visit prospective customers and demonstrate the sets for them."

From the first they had the problem of the "gyp" dealer to encounter—the firms with no reputation to maintain, who would buy second-hand outfits and inferior accessories, and then run big advertisements featuring the low prices of their sets. Having sold a set on price they gave no attention to service. Indeed, their policy seemed to be when called upon to do

repairing to leave the set in such shape that before long more repairs would be needed—with the costs piling up all the time.

First-class Service Department Established

"One of the first things we did," said the manager, "was to establish a first-class service department, and we have found it one of the best methods of combating the cut-rate store. The man who buys a cheap set and then has

Lyon & Healy, one of the most successful stores selling musical instruments in the entire country, are operating a profitable radio department as the result of the merchandising policies outlined in the accompanying article. The basis of all radio sales promotion at this fine Chicago store is service to the customer and insurance of satisfaction.

constant trouble in securing competent service when anything goes wrong, is very appreciative of real service, and in many cases discards his cheap set, purchases one that is reliable and remains a good friend of our firm because he is serviced promptly and efficiently when he needs it.

"We have never recommended the building of sets, but advise our customers to purchase sets complete. A man may get a lot of fun out of a set he makes for himself, but it is usually no more satisfactory than if he attempted to make a Victrola without the proper scientific knowledge. Another thing—any firm with a reputation to maintain would be expected to service a set for which he sold the materials—which is very unprofitable, as no matter how good the materials, if they are not put together

properly there will always be something wrong with it.

Speaker Department Is Help to Buyers

"Our big speaker department has been responsible for no small share of our success. Trouble with speakers is apparently one of the main things with which the radio purchaser has to contend. Accordingly, we have a special room where a series of speakers is installed, one of each kind kept in stock. With the assistance of a mechanical device installed in connection with the radio set and controlled by a telephone type switchboard, each speaker can be demonstrated separately. In this way a customer can compare the respective merits of the speakers, demonstrated at the same volume.

How Buying Terms Are Arranged

"The privilege of extended payments is accorded our customers, but we have found it better to make the time shorter than usual. Formerly, six months' time was given to liquidate the account, but experience has proved that four months, which now obtains, is more satisfactory. One-third of the amount is required down, and the balance arranged in four monthly payments. In a few cases, where the credit references are exceptionally good, the time has been extended to six months, but as a general policy it has been found better to observe the short time limits. Many stores ask one-fourth down, with twelve months to pay, but we have found it better to stick to the short time and have no repossessions, which are never profitable. There are so many changes in radio in six months' time that many time-paying customers feel they would like to have one with all 'the latest improvements,' and importune the dealer to make an exchange before they had fulfilled the requirements of their contract.

Sets Sent Out on Ten Days' Trial

"The unreasonableness of certain customers was likewise demonstrated in connection with our former policy of selling the sets subject to thirty days' approval. It was found that many would assume a disgruntled attitude—think their neighbor's set better than their own—a better buy for the money, etc. For this reason our policy was changed and sets are now sent out on ten days' trial with a nominal charge for installation. It is possible to find out all there is to learn about a radio set in ten days' time and a longer time only results in confusion. If a prospect is not fully sold when in the store we send out a set on ten days' trial. We make a small charge for installing the machine, but give sixty days' guaranteed service, which means that should any set be found defective in any way it will be remedied without charge. Battery replacement or the paralyzing of tubes, the latter one of the most frequent difficulties of green operators, entails a moderate charge for service.

"Service is the keynote to our success, and with it we have found it possible to maintain prices, and sell on the quality instead of the price, which is the only way of keeping a set successfully 'sold.'"

Stewart-Warner Distributor Sponsors Radio Concerts

DES MOINES, IA., December 7.—The Stewart-Warner Products Service Station, distributor of Stewart-Warner radio receivers, reproducers, tubes and accessories, is sponsor for a series of seven radio concerts, known as the Stewart-Warner Matched-Unit Radio Programs, which are being broadcast every Monday evening from eight to nine, Central Standard time, from Station WHO.

Customers Will Ask You
for the New

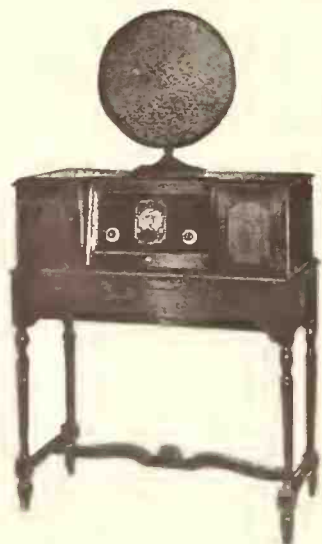

MU-RAD

SUPER-SIX RECEIVER

Will You Fill Their
Order or Lose a Sale?

Six years of continuous publicity, sane merchandising and positive value have made for Mu-Rad a name that is respected by dealers and public alike. This new Mu-Rad Receiver is all that earlier sets have been, and more.

Your customers have read Mu-Rad's announcement of the new Super-Six Receiver. You will be asked for Mu-Rad demonstrations. Will you be ready? Mu-Rad's dealer policy is generous, fair and square and as old as radio. Write today for franchise in your district.

For Territorial Rights
Address

MU-RAD
Radio Corporation
Dept. W

Asbury Park, N. J.

LOGIC

ANY radio retailer able to confine his dealings to one large and responsible concern which manufactures a complete line of receiving sets that will meet all his requirements is indeed in a fortunate position. Federal Designated Retailers, operating on this basis, are enjoying bigger and better returns than otherwise possible. And for these reasons:

- 1 The Federal plan gives the retailer an opportunity to concentrate on fewer lines, and in his advertising and selling statements to be consistent in his recommendations to his customers.
- 2 The general Ortho-sonic *Line* through its all-satisfying range of models and prices, simplifies ordering and inventorying, and results in faster turn-over and better profit margins.
- 3 The Retailer realizes that a manufacturer, willing to forego maximum immediate profits for the sake of perfecting and producing *simultaneously* a varied line, must be inspired by a grim determination to build and to *hold* a respected position throughout the years.

The advantages offered by the Federal Plan are too unusual ever to be overlooked by the retailer who is sincerely ambitious. Write your Federal wholesaler for full details. If you don't know his name, write us.

ORTHO-SONIC[★]

Federal Radio

Reg. U. S. Pat. Off.

*The fundamental exclusive circuit making possible Ortho-sonic reproduction is patented under U. S. Letters Patent No. 1,582,470



The sign of the Designated Federal Retailer

FEDERAL RADIO CORPORATION, Buffalo, N. Y.

(Division of Federal Telephone and Telegraph Co.)
Operating Broadcast Station WGR at Buffalo

Profit Winning Sales Wrinkles

Cashing in on Window Display of a Single Record—Radio Dealer Uses Testimonials to Create Sales—Unique Record Enables Dealer to Analyze Buying Trend—Books Increase Friedman's Profits—Advertising on Milk Bottle Caps—Other Unusual Stunts

The policy of occasionally devoting the window display space of a retail music store to featuring a single record has in many instances proved very successful in not only stimulating the sale of the record featured, but also aiding sales in other lines. The dealers find that an unusual window display has the tendency to bring people into the store, permitting the dealer and his salesmen to bring to their attention new instruments and new record releases. Within the past few months the Distributing Division of the Okeh Phonograph Corp. has been co-operating with its dealers in arranging displays featuring record releases, and in each

case the dealer reports stimulation of sales. Both Charles Silverberg, of 178 Myrtle avenue, Brooklyn, N. Y., and the Reo Talking Machine Co., 434 Lenox avenue, New York, used the following stunt to push sales of the Okeh record, "King of the Zulus." A colored man was engaged and garbed in Zulu fashion to cut up capers in the window, which was decorated and contained literature pertaining to the recording. The Lazar Music Shop, of 312 West 145th street, New York, selected "Lil' Farina" as the record to be featured. A complete set of photographs of "Lil' Farina" and her playmates in the "Our Gang" comedies was arranged in the window, together with display material provided by the Okeh Corp. A little colored girl dressed like "Lil' Farina" was in the store distributing photographs of the famous little colored motion picture star to customers.

Uses Testimonials

It is a kink of human nature that a person who reads the testimonial of a product in an advertisement will be doubly interested if it should happen that the signer of the approving letter happens to reside within the neighborhood or district in which he is a resident. It does not matter that the signer is as unknown to him as though he lived thousands of miles away—the familiar address seems to add sufficient weight to the testimonial to give him faith in the product. Realizing this, the Miller Hardware Co., of Maysville, Mo., recently issued a booklet filled with testimonials received from owners of Atwater Kent sets in Maysville and vicinity. The last few pages of the booklet are given over to illustrations of sets and speakers. This company uses the booklet to enclose in envelopes and as a piece of direct-mail literature and has found it successful in developing many sales.

Aid to Sales Analysis

A talking machine dealer in Ohio keeps an accurate record of the sales of the various type instruments and thus is able to judge with a fair degree of certainty the trend of demand. A large ruled ledger sheet is used for each style of instrument. The sheet contains space for the name and address of the person to whom the machine was sold, the date, number of instrument, cabinet style and finish, as well as price. Thus all of the console models, for example, that sell at a certain price are listed on one sheet as soon as sold. Other sheets are kept of the other models. Analysis of sales over a period of a month, several months, semi-annually, etc., gives the dealer an idea of what is selling and he can thus control his buying, avoiding overstocking on styles for which there is very little demand.

Profits From Books

About a year ago Joseph Friedman, operating a talking machine store on Clinton street, in the lower East Side of New York, started a circulating library for the purpose of bringing people into the store regularly so that the latest records could be demonstrated and sheet music be presented. From the beginning, with a couple of hundred of "best sellers" on the shelves, this department more than paid its way and an increase in sales of records was noted. At the present time the library contains thousands of titles and the weekly revenue from readers is in the neighborhood of \$100. Mr. Friedman is so enthusiastic over the success of the venture that he is adding more space to the book shelves and he claims that in time the rental of the large store which he occupies will be paid in full by the money received from the rental of the books. Aside from the profits which

are being made, when it is taken into consideration that 400 people belong, and each week or two these people come into the store and in many cases readers come several times during the week, it can be easily seen that the dealer and his sales staff have an excellent opportunity of interesting them in records, sheet music, small musical instruments, and in some cases the larger units of phonographs and radio receivers. Getting the prospective buyers into the store has always been the dealers' problem. Here is a method that succeeds admirably and, at the same time, brings a cash profit in itself—what could be fairer than that?

Unusual Advertising

Straying a bit from the beaten path has in innumerable instances secured for the dealer who chooses unusual methods of obtaining publicity and stimulating sales results which are far better than sticking to conventional plans. A recent interesting example of the manner in which the E. G. McKinney Hardware Co., of Durant, Okla., Atwater Kent dealer, advertised the line bears retelling. This firm purchased milk bottle caps in large quantities and sold them to dairymen and milk dealers at cost price. Each cap carried the message "Atwater Kent radio is sold at McKinney's." Mr. McKinney, proprietor of the store, believes this message, going to many homes every day, is an excellent medium for dealer advertising.

Holiday Circulars Pay

During the few weeks preceding the holiday season the talking machine dealers' sales volume should reach the peak for the year. Whether it does so depends largely upon the effort put forth by the merchant to interest the public in the products he sells. To this end sales-promotion campaigns reach their climax. Laudau's Jewelry & Music Stores, in Wilkes-Barre, Pittston and Hazleton, Pa., are doing something this year that other dealers may find worth while, even with the limited time still available to the public for holiday buying. It is simply a special booklet showing the various lines handled, descriptions and prices, which is being mailed to every customer and prospect on the mailing list of the firm. The booklet is in keeping with the Christmas spirit and presents a potent argument in favor of making this a musical Christmas.

Publicity on Bags

Spargo & Co. "The Musical Shop," of Hazleton, Pa., believe in keeping their name before the public. This concern operates a modern talking machine department and also a musical merchandise section. A number of small bags are used for the numerous accessories that are in constant demand. On these bags appears the following message: "The various articles of merchandise on sale at our store have been selected with the greatest care, and it is our hope that every purchase shall prove entirely satisfactory. If it does not, please feel perfectly free to return it for adjustment. Superb strings for violin and ukulele have proved themselves superior over a period of forty years. We recommend them to you as the very best procurable." Spargo & Co. are constantly working to create customer satisfaction and this little stunt has done much to make dealings with patrons pleasurable and profitable.

Features Masterworks

The branch store of the New York Band Instrument Co., New York, having on hand an old sheet music rack of the type which stands on the floor and contains a half-dozen or more shelves for display purposes, having no use for it in the sheet music department, used it to display the Columbia Masterworks Series of records to very good advantage.

The Phone Distributing Co., New York, musical instruments, was recently incorporated at Albany with a capital stock of \$20,000. The incorporators are H. Anderson, O. A. Olsen and F. Forman.

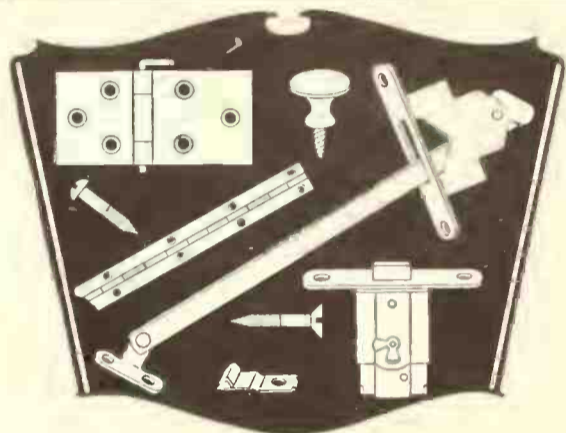

Rockford Hardware

The Rockford Line of Hardware is complete. Over 300 high grade items for pianos, phonographs and radio cabinets. Your needs can all be supplied to advantage. Quick delivery assured from our centrally located factory.

Write today for samples of items you use, and catalog.

**National Lock Co.,
Rockford, Ill.**

U. S. A.

Cable Address—Natlock

Branch Sales Offices:

Chicago, Ill.	Indianapolis, Ind.
Cincinnati, O.	Jamestown, N. Y.
Detroit, Mich.	Milwaukee, Wis.
Evansville, Ind.	Seattle, Wash.
Grand Rapids, Mich.	Sheboygan, Wis.
High Point, N. C.	St. Louis, Mo.
Los Angeles, Cal.	



PERRYMAN P RADIO TUBES

"Distance without Distortion"

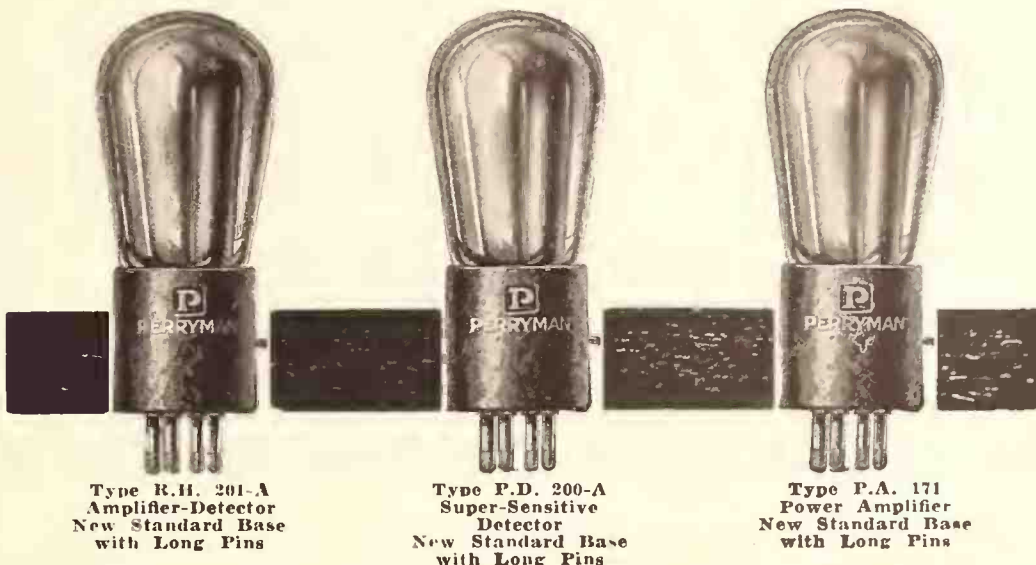

Type R.H. 201-A
Amplifier-Detector
New Standard Base
with Long Pins

Type P.D. 200-A
Super-Sensitive
Detector
New Standard Base
with Long Pins

Type P.A. 171
Power Amplifier
New Standard Base
with Long Pins

Teamwork!

Preach the gospel of tube teamwork and make five or six sales instead of one. Many of your customers are buying new super-sensitive detectors and using out-of-date amplifying tubes. Others are putting good power tubes on the end of a line of antiquated detector-amplifiers that gum up the works. . . . Every set needs a super-sensitive detector, modern amplifying and an efficient power tube to function properly. Tube team work—that's what does the trick. And the best team always wins — Perryman Radio Tubes.

Perryman Distributors are equipped and ready to supply you with tubes, advertising literature and helpful cooperation

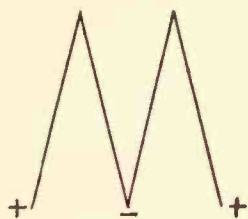

The filaments of Perryman Radio Tubes with the patented Perryman bridge are doubled to form a letter M. This twin construction not only exposes a greater area of filament surface, but it doubles the area of electron emission and increases the capacity of the tube. The real result is a tube that does its appointed work more easily, giving greater volume without distortion. Its longer life is a distinct economy.

The clear glass demonstrating tube shows the patented Perryman Bridge which holds the elements in place at the distance of greatest efficiency. Ordinary jars or jolts do not affect Perryman Tubes.

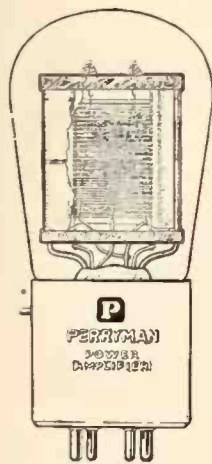

Patented June 22, '26

Let Post Office Check Your Mailing List

Local Postmaster Has the Authority to Correct Dealers' Mailing Lists—Accuracy Eliminates Waste in the Direct Mail Sales Effort

Every dealer in talking machines or records or radio apparatus maintains, or should maintain, a mailing list of customers and prospective customers of the store, for a very substantial proportion of possible business lies in the following up of customers by mail. This same rule holds good in every business where a large proportion of the trade is in additional accessories or replacements, as in the case of records.

Accuracy in Mailing List Important

The efficiency of the mailing list, however, depends primarily upon its accuracy, and there is hardly a factor in business that can deteriorate so rapidly as the mailing list unless it receives constant and intelligent attention to keep it alive. A list that is 100 per cent perfect to-day, if such a thing is really possible, may be only 90 or 95 per cent perfect a month from now, and then continue to go down the scale unless some sort of a check-up is made to see that no waste material is being carried in it. People move, die and experience changed circumstances with great frequency and without notice, particularly in urban communities where sticking to the old homestead means nothing and where a change of home requires simply the services of a gang of movers to take the housefurnishings from one apartment to another.

Cost of Wasted Literature

Every decadent name or address on a mailing list means the loss of from five to twenty-five cents cash each time a piece of literature is sent out by the dealer. Multiply that by the number of incorrect names and addresses found on the average list of one thousand or two thousand names and it represents a substantial total of money that might better be expended for some other purpose. Numerous dealers follow the usual routine of printing a return postage guarantee on the envelope to insure its return should the address be wrong. This checks up with more or less accuracy on those who have passed away, but is of little value in tracing prospects who have moved to other localities and made arrangements to

have their mail forwarded to the new address.

Then, again, other retailers resort to the return postcard system, not only for checking up on names and addresses, but to learn whether the prospect's interest in the merchandise offered is still alive. For example, if the customer has disposed of his talking machine he is no prospect for records, and the record literature sent him each month is for the most part wasted.

Any checking up done direct by the dealer is an expensive process and is to be endorsed only for the fact that failure to have some check on the mailing list means the waste of material of much more value than the expense of a little mail detective work.

Employ the Post Office

The logical method for keeping the mailing list alive and up-to-date, however, is to have the Post Office Department itself do the checking. It is not generally known that the local postmaster has authority to check mailing lists of business houses in his district against the key list at the post office itself, charging for the service at the rate of sixty-five cents per hour, or the actual pay of the postal clerk engaged in the work.

Formerly this checking service simply provided for the elimination from the lists of those who had moved out of the postal district for one reason or another and the insertion of correct addresses where such were lacking. The importance of the work has been appreciated, however, and postmasters are now authorized to insert new addresses in place of old where persons have moved and left forwarding addresses. As the postal list is subjected to what is practically a daily check by carriers, it may be considered as nearly correct as possible.

It is suggested that when the mailing list submitted covers several postal districts that the list be divided by the business man according to such districts, which will save considerable time and consequently money in the work of revision. Time will also be saved when the lists are submitted in alphabetical order, as this facilitates the work of checking. Although the

charge made by the post office for this checking service is on the basis of actual cost of the clerk's time, the work is not altogether altruistic, for the reason that a clean and corrected mailing list facilitates the work of the post office itself through making deliveries easier and quicker and avoiding much of the trouble of checking mail matter that is incorrectly addressed.

Dead Ones Don't Buy

Modern merchandising is an intensive proposition and every bit of wasted effort that is expended detracts just that much from the volume of business handled. To carry on direct mail campaigns with a list that includes a noticeable percentage of dead and useless names means that just that proportion of the campaign, with its costs and the efforts put into it, has gone for naught. It is a matter of economy to keep the mailing list up-to-date, for then practically every piece of literature actually gets into the hands of someone who is presumed to be interested in what the dealer has to offer. To insist on endeavoring to do business with a dead mailing list is comparable to expecting a large volume of sales to be made in a cemetery. The dead ones don't buy.

Freshman October Sales Show Increase Over 1925

Net sales of the Chas. Freshman Co., Inc., for the month of October, 1926, totaled \$1,482,913, an increase of 15 per cent over the net sales for October, 1925, which were \$1,290,174, according to a report issued to stockholders by Chas. Freshman, president. Mr. Freshman further stated that the total net sales from June 1 to October 31, 1926, showed an increase of 38 per cent over the corresponding period of 1925.

Commenting upon these figures, Mr. Freshman said that the October sales, in spite of the substantial increase, were handicapped through the company's inability to secure sufficient console cabinets to meet the demand of the trade. In order to eliminate this condition in the future, Mr. Freshman stated that the company is considering acquisition of one or more furniture factories.

Plan Display Contest for McDonald Howl Arrester

A window display contest, with prizes totaling \$2,000 in gold, is being conducted by the Spartan Electric Corp., New York, distributor of the McDonald Howl Arrester. The prizes are offered for the best window display of advertising material featuring this accessory, which is a live-rubber jacket that fits over each tube and is said to eliminate noises and howls. The contest is open to all retail stores selling radio supplies and will end on February 15, 1927. The winners will be announced in the March issue of *The Talking Machine World*.

"For Xmas and Ever After"

The advertisements of the Victor Talking Machine Co., which appeared in leading national magazines during the month, have stressed the slogan: "For Christmas and ever after—The New Orthophonic Victrola—The Gift that keeps on giving." The text matter of the advertisements describe the desirability of the Orthophonic and several models of the line are illustrated.

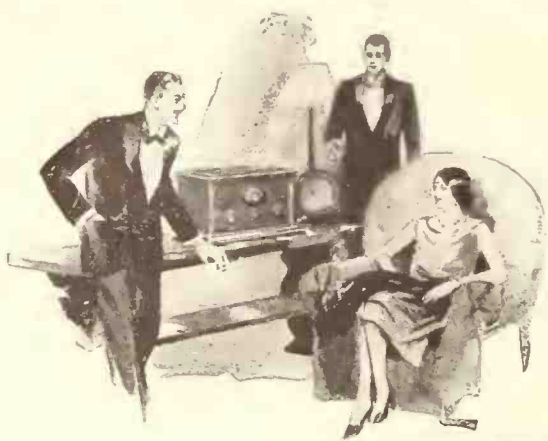

Is "everybody in town" selling the same line you sell?

MAGNAVOX

Single Dial Sets—Cone Speakers—Tubes take you out of indiscriminate competition by restricting distribution to the few.

Write

The MAGNAVOX COMPANY, Gen'l Sales Office and Factory, Oakland, Calif.
Chicago Sales Office: 1315 So. Michigan Ave.

The Reproducer Sensation of This Generation



The VAL PHONIC is constructed with a hand hammered metal diaphragm—thin as a hair—no blast, but plenty of volume.

Every detail of the new electric recordings is brought out with life like fidelity.

Its distinctive tone will win many record customers.

The Val Phonic is produced by the makers of Valley Forge Non-Jump main springs. Send for latest chart.

The VAL PHONIC is not just another reproducer, but a master work built along original lines to give *service that pleases.*

It appeals to the eye as well as the ear *and stays sold.*

HAVE YOU
HEARD IT?



Introduce Mikiphone Portable Phonograph to Trade

Popular European Miniature Portable Phonograph Is Placed on American Market—Has Proved a Big Success on the Continent

A novelty in portable phonographs is being introduced in this country by the Mikiphone S. A. Inc., with headquarters at 44 Whitehall street, New York. This unique instrument which is known as the Mikiphone, is a portable phonograph that may be slipped in a pocket, for it weighs only two and three-quarter pounds. The instrument is made in Switzerland and the American distribution is under the direction of C. Rotvand, who is prominent in European commercial circles. The Mikiphone portable phonograph was invented by Stefan Vadasz, who has secured many patents covering the distinctive features of the instrument. The shape of the phonograph is circular and in its metal case has a diameter of only four and one-quarter inches.

The outstanding feature of this new type of phonograph is the sound amplifier which is attached to the sound box with the tone lever operating as a speedometer and brake. The motor, which is made in Switzerland, is guaranteed to play a full ten-inch record with one winding.

The immediate recognition of the Mikiphone in European countries is reflected in the publicity that it has attained in musical and commercial circles. Mme. Mistinguett, the most popular musical comedy star of Paris, sings a selection devoted entirely to the Mikiphone, and newspaper publicity has been accorded the phonograph in practically every leading European country.

G. E. Palmer Sales Mgr. for Greene-Brown Co.

George E. Palmer was recently appointed sales manager of the Greene-Brown Mfg. Co., Chicago, manufacturer of the Brown "B" battery eliminator, according to an announcement from the firm's headquarters. Mr. Palmer has had an extensive experience in radio, is also a mechanical and electrical engineer, and for some time past he has been connected with the Daven Radio Corp. of Newark, N. J., in charge of manufacturer's sales.

The Greene-Brown Mfg. Co. has been producing the Brown "B" current supply unit for about four months and a number of prominent distributors have added the product to their lines, among them being the Empire Electric Mfg. Co., Milwaukee; Louisville Auto Supply Co., Louisville, Ky.; Friday Battery & Electric Co., Ottumwa, Ia.; Excelsior Radio & Battery Co., Harrisburg, Pa.; Wetmore Savage Co., Boston, and branches throughout New England, and the Van Ashe Radio Co., St. Louis.

Panatrope Aids Sales of Roadside Confectionery

BAKERSFIELD, CAL., December 7.—The Brunswick Panatrope, accompanied by a trap drummer, stimulated trade of Day's Confectionery & Gas Station to such an extent that within a few days after the installation of the instrument cash sales were more than tripled. The owner of this roadside confectionery saw the possibilities of the Panatrope and purchased the instrument from Urner and James, local Brunswick dealers. This music store is a firm believer in the efficacy of demonstrations and it has had great success in selling Panatropes by this method backed up by billboard advertising.

Paul Specht has signed contracts with the Columbia Phonograph Co., covering the recording of his Original Orchestra and also of the Georgians. In addition, his two Great Britain orchestras also will record for Columbia.



AA18 List \$45



The Luxurious AMPLION PATRICIAN

reproduces the true gaiety of Holiday Music! Distinguished in appearance—Nationally Advertised—For the discriminating Radio Public, the ideal Yuletide gift!

The trade emphatically endorses new Amplion developments

AMPLION CONE-AMPLION PATRICIAN

—our plants at New York and Muskegon are running to full capacity—working overtime! For timely deliveries may we advise ORDERING IMMEDIATELY? Do not miss any Christmas Sales on these profitable new Amplion numbers.

Write for name of Jobber in your territory

THE AMPLION CORPORATION of AMERICA

Suite C, 280 Madison Ave., New York City

The Amplion Corporation of Canada Ltd.
Toronto, Canada

AC12 AMPLION CONE List \$30.00

DRAGON MODELS

AR19 Amplion Dragon List \$42.50
AR114 Amplion Junior de Luxe List \$27.50
AR111 Amplion Junior List \$24.00
AR102 Amplion Dragonfly List \$12.00

PHONOGRAPH ATTACHMENTS

AR35 Amplion Concert Grand List \$20.00
AR67 Amplion Standard Unit List \$12.00



Long-Term Instalment Sales Bad Practice

Contracts Extending Over a Long Period of Time Tie Up Dealer's Capital and Undermine Business — Short-Term Sales Profitable

The terms at which products are sold at retail can make or wreck a business, for every instalment contract means a drain upon the capital resources and the longer that contract is for, the greater the capital drain. Short terms mean quick capital turnover. This statement is in no sense a brief for members of the banking fraternity who are declaring from the housetops that instalment selling on general principles represents a menace to the credit fabric of the country, but it is true, nevertheless, so far as it affects the dealer who is so anxious for sales that he sacrifices his good credit judgment.

Danger in Long-Term Contract

There was a time when, with talking machine sales averaging only about \$100 per unit, it was regarded as a matter of wisdom to keep the time payments within a single year, and in most cases within a six months' period. With units now offered to the public, however, running in value from \$600 to \$1,000, there is an inclination in some quarters to extend the contract period and thus detract the attention of the customer from the amount he is pledging himself to pay.

This situation is liable to lead to evil unless held in check by the dealers themselves. The theory of having terms extended as the amount of the purchase increases is a mighty poor one, for if such tactics are necessary it means that customers are buying outfits far beyond their means, and are not sound credit risks. An authority has put it well when, on being asked regarding his idea of the proper down payment on a given sale, he replied: "Get a large enough payment at the outset to make the customer realize that he is buying the machine and not simply renting it." In other words, the amount should be sufficiently large to command respect.

With the holiday season coming on, and a distinct scarcity already apparent in certain lines of popular merchandise, particularly the newer models of phonographs, the retailer owes it to himself to see to it that terms are kept within reasonable bounds. With a limited number of instruments at his command he is facing, temporarily, a sellers' market and can afford to choose his customers to a certain extent at least. When he lets popular models go out of his store on terms that carry payments over a period of fifteen or eighteen months he is not only tying up that much capital, but he is throwing away the possibility of selling that same machine to a more substantial customer for cash or on a basis that approximates cash.

There is quite a hullabaloo made at various

times regarding the entrance of the automobile dealer into the field of instalment selling, it being maintained that some 80 per cent of all cars sold at present are sold on terms. It may be that selling motor cars on time provides a new form of direct competition for the prospect's dollars, which means that it draws money from other retail interests after those same dollars. So far as interfering with the existing instalment terms, however, the automobile merchant has tended to stabilize that type of business. Minimum down payments of approximately 25 per cent are demanded in motor car sales, and the balance must be cleaned up within a year of monthly payments amounting, at times, to \$200 or more each. In addition the customer pays for insuring the car against fire and theft during the period of the instalment contract and also pays financing charges.

A Plan Worth Emulating

It might be well for talking machine dealers to take a leaf from the book of the automobile men, and to set a minimum of 25 per cent instead of the usual maximum down payment of 20

per cent and insist that the contract be cleaned up within the year regardless of the amount, making the smaller sales pay out in a shorter period where possible. The dealer who under present conditions in the trade advertises terms and tries to do business on the "nothing down and two years to pay" basis is simply cutting his own throat. He may be building up sales volume, but at a cost that leaves him little if any profit at the end of the year.

More Cash and Larger Profits

When there is an overplus of stock and selling conditions are poor there may be found some excuse for moving machines on a basis of long terms, but that method should be considered as a desperate step. With the market sound and stocks short, there lies the opportunity for getting business that is profitable, the sort that means cash in the till rather than paper in the safe. It may mean a little extra salesmanship and the heart pang that comes when a prospective customer walks out without buying, but in the long run it will mean more cash and more profits.

Christmas Time Is Music Time Told in Victor Posters

Some Striking Dealer Publicity Recently Issued by the Victor Talking Machine Co.—Features "The Gift That Keeps on Giving"

"The Gift That Keeps on Giving" is the slogan which is stressed in the Christmastime selling material supplied Victor dealers throughout the country by the Victor Talking Machine Co. First and foremost are the window posters, consisting of a large centerpiece and two side posters in beautiful, deep brilliant colors, with a blue background and a border of the conventional holly wreath in green and red. The large center poster bears the slogan mentioned above; and on one side poster is printed "The New Orthophonic Victrola," on the other, "The New Orthophonic Victor Record." An accompanying folder gives two illustrations of windows in which good use is made of this material in dressing a most attractive display. The record hangers are designed in similar brilliant colors and contain a widely varied list of Victor records for Christmas, which should be used to good advantage by dealers.

A special folder describing and illustrating the full line of Victor Orthophonic instruments and Radiola combinations is also included in the selling material. The cover of this booklet is most beautiful and bears an illustration in

pastel tints of a host of angels rising in a cloud from the homes of a snow-clad village, each one playing a musical instrument. The caption on the cover of the folder is "Christmas Time Is Music Time."

New Radiotron Sales Help

A new Radiotron sales help in the form of artistically colored red, white and black tube display containers is now available to R. C. A. authorized dealers. One type holds three tubes of the UX-201-A size and the other accommodates four of the UX-199 type. These cartons, which make unusually striking counter and window display material, were designed as an aid in selling the three or four tubes on display where only one was previously bought. This encourages the idea of keeping spare tubes handy in the home. The containers are available to dealers without charge, but the supply is limited, according to R. C. A. officials.

Stages Radio Show

MARSHFIELD, ORE., December 6.—The L. L. Thomas Music Co. held its annual radio exposition for a week the latter part of last month and was most successful in attracting thousands of prospective radio buyers to attend the display and demonstrations of the latest radio equipment.

GILFILLAN RADIO

SWEETEST TONE—HIGHEST SELECTIVITY

SIMPLEST OPERATION

GILFILLAN BROS. INC.

25 Wilbur Ave. 1815 Venice Blvd. 2525 W. Penn. Way
Long Island City, N. Y. Los Angeles, Calif. Kansas City, Mo.



Why Eveready Layerbilt is
*the most economical “B” battery
ever built!*

HERE, in the radically different Eveready Layerbilt, is the “B” battery which tops them all. Instead of the usual assembly of round cells, it is built of flat layers of current-producing materials. This construction, exclusive to Eveready, makes use of the spaces now wasted between the round type cells and avoids the usual soldered wires.

Test after test has proved that this battery is the most economical “B” battery ever built, and you can make that flat-footed

statement to all your customers. Tell them that on all loud speaker sets the Eveready Layerbilt will give twice the service of the smaller Light-Duty batteries. It is far and away the

most economical source of “B” power obtainable. It is also the most reliable and dependable. It delivers pure D. C. (pure direct current) which is essential to true tone reproduction. This is the best “B” battery we have ever built, and we firmly believe that it is the best “B” battery available on the market today. Order from your jobber.

Tuesday night means Eveready Hour—9 P. M., Eastern Standard Time, through the following stations:

WEAF—New York	WTAM—Cleveland
WJAR—Providence	WWJ—Detroit
WEEI—Boston	WGN—Chicago
WTAG—Worcester	WOC—Davenport
WFI—Philadelphia	WCCO { Minneapolis
WGR—Buffalo	{ St. Paul
WCAE—Pittsburgh	KSD—St. Louis
WSAI—Cincinnati	WRC—Washington

EVEREADY
Radio Batteries
-they sell faster

Manufactured and guaranteed by
NATIONAL CARBON CO., Inc.
New York San Francisco
Atlanta Chicago Kansas City
Canadian National Carbon Co., Limited, Toronto, Ontario

How an Intelligently Selected Sideline Eliminates Periods of "Trade Depression"

Hanley Found a Camera Department a Profitable Investment Because These Products Sold Particularly During the Seasons When His Main Business Slowed Down—Other Sidelines

One of the greatest problems of the retail talking machine and radio trade to-day is to overcome slow periods, when sales slump and no effort seems to be very effective in creating business. There is no denying the fact that dealers and their salesmen are so rushed at times that they are hardly able to cope with the situation, and at other times they are practically idle, while overhead goes on just the same.

There are several logical solutions, the most feasible of which seems to be for the dealer to add a sideline that will move during those seasons of the year when talking machines and radio are naturally not in great demand. The selection of a sideline, however, must be carefully made. The dealer must

analyze his territory and actually gauge the sales possibilities of whatever line he is thinking of installing. It is foolhardy to invest a substantial sum of money on a chance that it will sell. The retail merchant is in no position to guess. He must know.

Hanley, a progressive dealer of Kansas City, Mo., found himself up against this condition. He discovered that there were some months in the year when radio did not sell in the volume that he thought necessary. In other words, his sales curve was uneven, and he realized that this represented inefficiency and waste. Inefficiency because no business can return maximum profit when it is a part-time enterprise and waste because during the slack period salesmen were idle and overhead consumed profits made during the more busy times.

Hanley carefully analyzed the situation and determined to add a line of cameras and photo supplies to supplement his main business—radio. During the season when radio sales drop the camera department comes into its own; when radio sales are at their peak the camera department is not quite so busy, although sales are made the year around, and the department has shown a handsome profit on the investment.

There is another feature of the sideline that is worthy of consideration; it brings people into the store, and anything that accomplishes this is eminently worth while. The progressive dealer spends huge sums of money annually in advertising, gives a great deal of thought to arranging striking windows and sends out quantities of direct mail—all for the purpose of interesting people to the point where they will come into his store. One thing is sure, the people who buy a camera from Hanley, and those who take their films there to be developed, do not lose sight of the fact that he handles radio. He has established a contact that actually increases business in his main department. He is also constantly building good will that means increased sales and profit. There are many other sidelines that will accomplish the same purpose. For example, there is fishing tackle and other sporting goods—especially appropriate during the Summer months. There are small musical instruments and other lines that will occur to the dealer who spends any time at all thinking about sidelines.

Stevens Conoidal Speaker Used by Station WMSG

Madison Square Garden Broadcasting Corp. Gives High Praise to Speaker Which Is Being Used in Reception Rooms at Station

The broadcasting station WMSG, Madison Square Garden, New York, has adopted the Stevens Conoidal Speaker for use in its reception rooms as well as for output control purposes. In making this announcement, J. B. Price, sales and advertising manager of Stevens & Co., New York, made public a letter from J. Bernhart, president of the Madison Square Broadcasting Corp., which states:

"The Stevens speaker, which we are using, I find is equal in volume to any of the recognized standard makes and is superior in quality to many of them. The reception of high and low notes is very satisfactory. The speakers are giving 100 per cent satisfaction."

Commenting upon the foregoing, Mr. Price stated that Stevens & Co. had always endeavored to place this speaker at the disposal

of the severest critics for use in places where it would be put through the most exacting tests, and the company has a large file of unsolicited testimonials from consumers and acoustical experts.

Efficiency of the Stevens speaker is attributed to two exclusive features, the Burtex diaphragm and the Stevens tensile tension unit. The Burtex cone is said to be chemically treated, thus making it impervious to all atmospheric effects, and its tensile strength is claimed to make it practically indestructible. It is said that the Stevens unit is the only cone speaker unit built on a tensile tension principle, which enables it to retain its high quality of tone even when subject to excess current.

Eva Leoni, Operatic Star, Recording for Columbia

Artist Has Won Large Following of Admirers Through Operatic Appearances in European, Metropolitan and South American Cities

Eva Leoni, operatic star on three continents, has recently completed her first record for the



Eva Leoni

Columbia Phonograph Co. The musical triumphs of this artist have been made in every opera center of the world. Miss Leoni was born in Vienna, of French and Italian parentage. A pleasing personality, combined with a coloratura soprano voice of great sweetness, soon attracted attention and with it came opportunity. Now the Columbia Phonograph Co. has made it possible for all to hear and enjoy her charming singing.

Televocal Corp. Announces New Power Detector Tube

A new power-detector tube, TC-200-A, has been produced by the Televocal Corp., New York, manufacturer of Televocal Quality Tubes. This has been added to the line of four other types now being manufactured. The chief features of Televocal tubes are that they are claimed to be non-microphonic and cannot short. These two features are said to be achieved by the use of the Televocal Support, a device invented by the company.

Feature Chargers as Gifts

PROVIDENCE, R. I., December 7.—The Apco Mfg. Co., of this city, is solving the age-old problem of "What to give for Christmas" in an admirable manner by boxing the Apco "A" charger in a holiday box for the Christmas season. H. R. Fuller, general sales manager of the radio department of the Apco Mfg. Co., reports that the holiday boxing of the Apco "A" charger has already resulted in substantially increased sales.

L. S. Burk has been appointed manager of the radio department of the Jordan Music House, Charleston, S. C.

Now!!

The KENT Attachment with the KENTONE SENSITIZED REPRODUCER

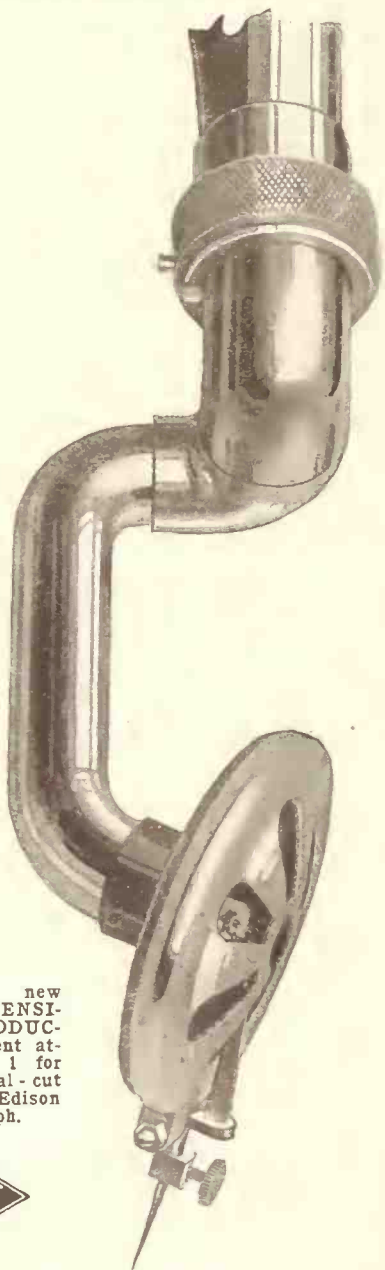

Here is the new KENTONE SENSITIZED REPRODUCER on the Kent attachment No. 1 for playing lateral-cut records on the Edison Disc Phonograph.



The KENTONE Attachment has been a successful and standard product for over twelve years. With the new KENTONE SENSITIZED REPRODUCER these two products in combination now are available at reasonable prices.

Write for catalog of complete line of tone arms and sound boxes

F. C. KENT CO.
Irvington, N. J.



Pontiac
\$140 List



Cherokee
\$65 List

*They
who believed
are Profiting -*

WHEN we announced the Mohawk One Dial Radio line for 1926-27, we offered to dealers an opportunity to sell looks, value, performance, and the fruits of a leadership gained through years of one-dial pioneering. Of these the latter is perhaps most important, but to see why requires foresight and keen merchandising sense . . . Hundreds of dealers had that foresight and merchandising sense and believed, as we did, that the pioneer in any field is best equipped in experience and prestige, and so is surest of leadership. They believed and they are profiting now with Mohawk One Dial Radio . . . Now that we have proof to add to promises, we urge again that you write or wire at once for the complete story of Mohawk One Dial Radio.

Mohawk Corporation of Illinois
Established 1920
Independently Organized in 1924
2220 Diversey, at Logan Boulevard, Chicago

SENECA—Mohawk One Dial, six-tube shielded radio set in walnut drawer. List price **\$57.50**

CHEROKEE—Shielded. Rich walnut hand-rubbed piano finish. Full piano-hinged. 10¾ ins. high, 13¼ ins. deep, 15½ ins. long. List price **\$65**

WINONA—Shielded. Rich walnut. 24 ins. long. List price **\$80**

CHIPPEWA—Shielded. Rich walnut, two-toned. Built-in loud speaker. List price **\$110**

PONTIAC—(In large illustration). Shielded. Burl walnut, drop front. Built-in loud speaker. 46 inches high. List price **\$140**

GENEVA—Shielded. Front full burl walnut, inlaid. Loud speaker built into dome, 44 inches high. List price **\$185**

POCAHONTAS—Shielded. Burl walnut inlaid. Built-in loud speaker with 7-foot horn. 45½ inches high. List price **\$300**

Prices west of the Rockies slightly higher.
Canadian prices 40% higher.

Mohawk One **Dial** **Radio**
Mohawk Corporation of Illinois
Established 1920
Independently Organized in 1924

Mathews' Outside Selling Brought Results

How a Progressive Dealer Planned His Canvassing Campaign and Followed Up Prospects—Other Ideas That Built "Talker" Sales

By Leo T. Parker

When Mr. Mathews invested his money in store fixtures and attempted to sell talking machines he had not proved his ability as a salesman. Probably one of the greatest attributes he possessed was his good judgment of human nature. And that is an important asset. Moreover, he was ambitious and in debt. The latter liability proved to be a qualification which assisted him materially in the successful outcome of his financial ventures. However, many other persons have possessed the same qualifications, and especially the latter, and still failed in business. Mr. Mathews started his phonograph business in a small town. He was well aware of the hard work he must do to succeed, and so this knowledge prearmed him against discouragement.

Doorbell Ringing Builds Sales Volume

When asked to explain his success, Mr. Mathews said: "At present I am familiar with the talking machine business, but when I began I had no previous experience in this line. I had read but little about the usual methods of practice by successful merchants. But before investing my small amount of money in the business I attended quite a large number of sales meetings held in a large phonograph establishment in a nearby city. I became aware of the fact that it would never do for me to sit inside the store and wait for the business to come in. Therefore, as soon as I had arranged things in proper order I employed a stenographer who, also, began to study the art of selling. After that I spent but little time in the store. And I soon learned that actual sales ability was not nearly so important as the number of hours work done each day. And, also, I discovered that long hours greatly assisted in obtaining orders. However, my main method of obtaining business is canvassing from door to door and obtaining accurate knowledge as to the kind of machines the various homes contain, and particularly I learned the location of the homes in which there were no phonographs. These I listed as prospects No. 1. Some of the homes contained wornout or old phonographs

and these I listed as prospects No. 2. In some other homes there were new phonographs and I listed these as prospects No. 3. I also established a regular mailing department, and each week I mailed my No. 1 prospects an attractive advertisement. To the No. 2 prospects I mailed advertising matter every two weeks. And to the No. 3 prospects I mailed advertising matter

That the dealer must make a determined effort to get volume talking machine business has been emphasized many times in the columns of The World. The accompanying article describes how several retailers are succeeding by putting in force original plans of outside sales promotion and supplementing these with carefully planned direct mail.

every month. It is to be presumed that I called on the same persons frequently. I included a list of the latest records in the circular matter, and attempted to influence the sales in this manner. Moreover, I never knocked a competitor. However, this is not saying that I did not attempt to prove that my phonographs were better than all others manufactured and sold. After making a sale I continued to call on my customers when I had no other place to go. By this method they realized that I was trying to please them. And that is exactly what appeals to them.

"I believe that the majority of salesmen who are unsuccessful are the type who never have time to call on a customer after a sale is completed. They do not realize the considerable

business lost to them by assuming this attitude. Satisfied customers are the most probable source of obtaining good future prospective purchasers. I received numerous tips of prospective buyers, and many times I gave a demonstration in the home of a user. When this was done, of course, the prospective purchaser was usually a friend of the owner, who frequently assisted greatly in closing the sale. An important thing is that my customers believe in me, and I make every effort to make them like me. The result is that I receive many telephone calls from my customers who request me to call on their friends who are in the market for a phonograph. And when an owner assists me to sell a phonograph I remember him with a few good records."

Letters of Recommendation Prove Useful

Another very successful salesman said: "There is no doubt that every salesman has a particular method for making sales. I have adopted but one regular plan and I find that one is the only plan I require. Probably it may not seem so important to the listener, but it serves me well and so I am satisfied with it. I obtain a letter of recommendation from each person whom I sell. Prospects are given an opportunity to know that I satisfy my customers as well as become impressed with the fact that my machine is a good one. Next, I carry about two hundred testimonial letters written by various persons who live in different sections of the city. It is not often that a prospective customer has an opportunity of reading a letter written by a person who lives close to him, but the letters serve the intended purpose. All of this assists materially in making a sale. It is true that there are many salesmen who do not have confidence in letters of recommendation to accomplish sales, but I know that my testimonial letters are means of securing orders. I always suggest that if the prospective customer desires he may immediately telephone any of the persons whose name he sees. In fact, I insist that he does. Of course, they are glad to say a good word for me to a prospective buyer, because they are my friends."

Still another successful salesman said: "During slack periods I specialize in selling portable machines. I find that by taking a sample in a small automobile and traveling about the city and outside communities sales are not difficult to make. In other words, I find that one must keep in mind the various circumstances in order to know just where the most profitable business may be obtained."

Gets Prospects Through Customers

Still another unusually successful salesman, when asked to explain his most successful sales plan, said: "First, one must be observant for live prospects. One good prospect is worth a dozen halfway ones. So I spend valuable time attempting to locate a good prospect. One way in which I always have obtained prospects is that I offer a free record to every owner who gives me the name of a live prospect, and then I give him three to five more records if I close the sale. The second is, I assume that when all of the good phonographs are considered, probably the workmanship of the best one is not much better than the others—price considered. And in talking to a prospect I dwell on the minor refinements, such as finish, convenience of operation and tone quality. And in transacting business with reasonably sensible persons I find they warm up to me, whereas if I knock all other machines and attempt to hold mine out as the only one, many business persons become prejudiced immediately and the sale is lost."

FULL LINE of HARDWARE

For Radios and Phonographs

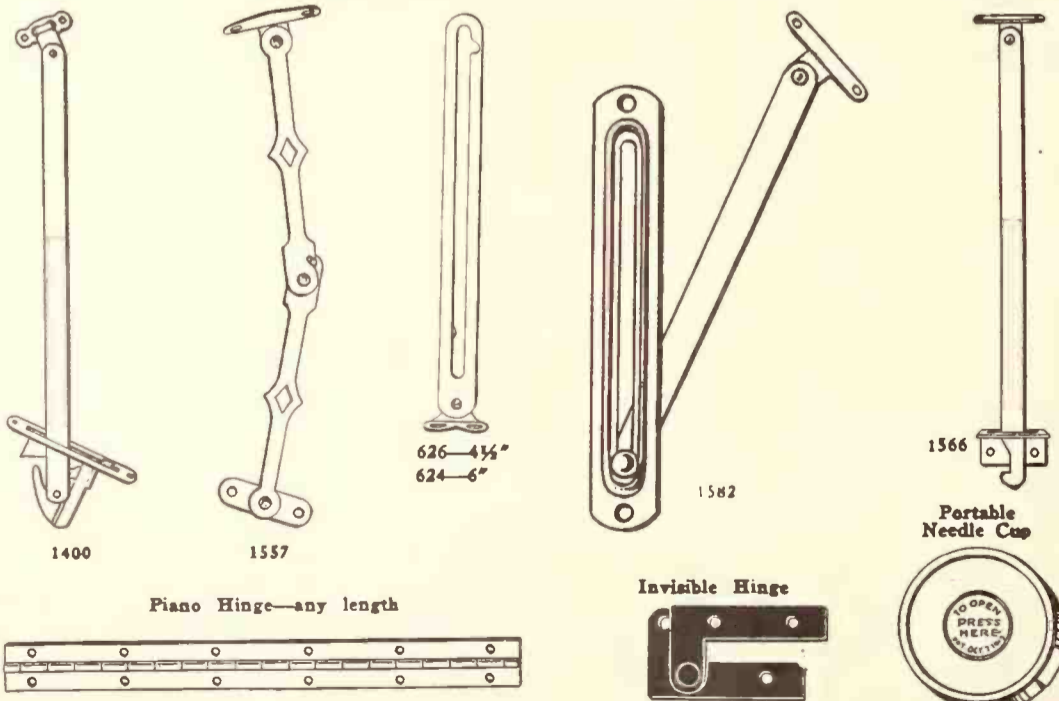

H. A. GUDEN CO., Inc.

87 WALKER STREET

NEW YORK, N. Y.

THE YEAR SAYS BUY!

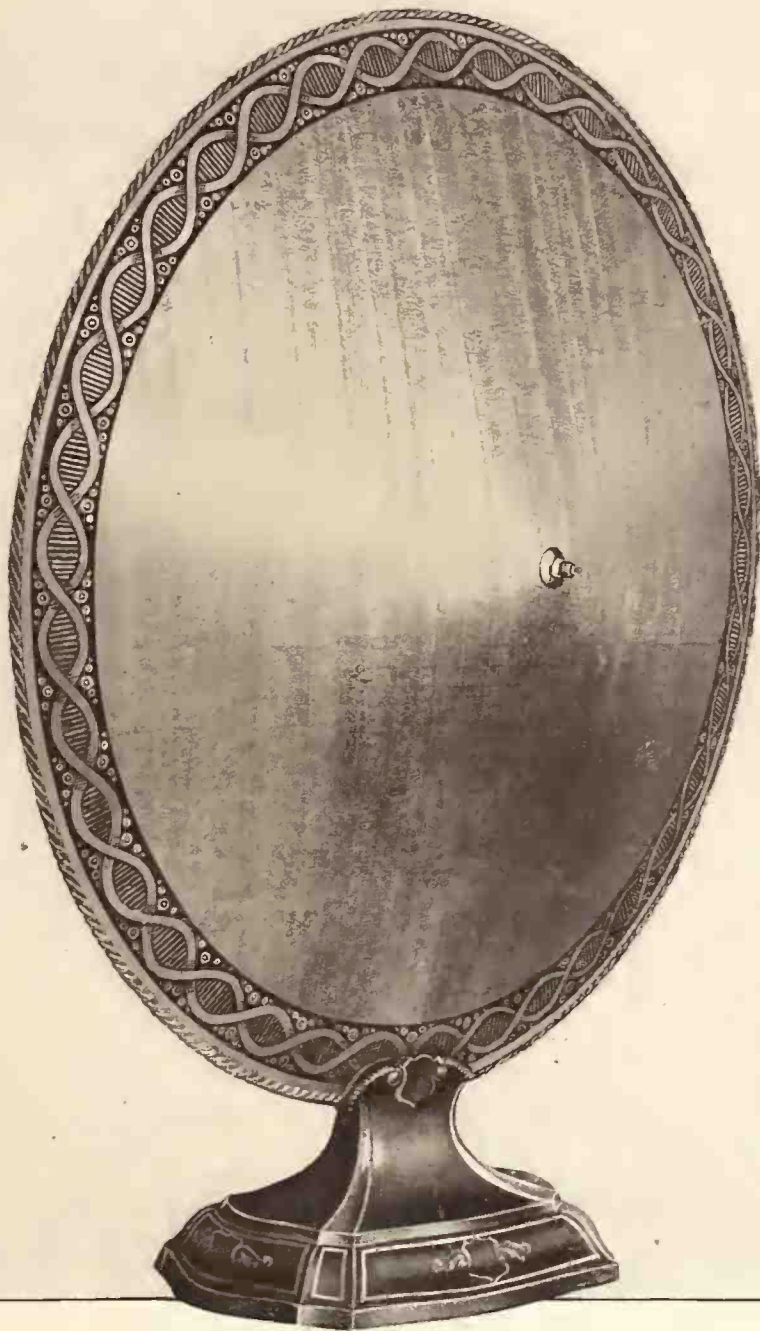

1927 JANUARY 1927						
SUN	MON	TUE	WED	THU	FRI	SAT
						1
2	3	4	5	6	7	8
9	10	11	12	13	14	15
16	17	18	19	20	21	22
23	24	25	26	27	28	29

1927 FEBRUARY 1927						
SUN	MON	TUE	WED	THU	FRI	SAT
			1	2	3	4
5	6	7	8	9	10	11
12	13	14	15	16	17	18
19	20	21	22	23	24	25
26	27	28				

1927 MARCH 1927						
SUN	MON	TUE	WED	THU	FRI	SAT
			1	2	3	4
5	6	7	8	9	10	11
12	13	14	15	16	17	18
19	20	21	22	23	24	25
26	27	28	29	30	31	

1927 APRIL 1927						
SUN	MON	TUE	WED	THU	FRI	SAT
						1
2	3	4	5	6	7	8
9	10	11	12	13	14	15
16	17	18	19	20	21	22
23	24	25	26	27	28	29
30	31					

1927 JULY 1927						
SUN	MON	TUE	WED	THU	FRI	SAT
						1
2	3	4	5	6	7	8
9	10	11	12	13	14	15
16	17	18	19	20	21	22
23	24	25	26	27	28	29
30	31					

1927 AUGUST 1927						
SUN	MON	TUE	WED	THU	FRI	SAT
						1
2	3	4	5	6	7	8
9	10	11	12	13	14	15
16	17	18	19	20	21	22
23	24	25	26	27	28	29
30	31					

1927 SEPTEMBER 1927						
SUN	MON	TUE	WED	THU	FRI	SAT
						1
2	3	4	5	6	7	8
9	10	11	12	13	14	15
16	17	18	19	20	21	22
23	24	25	26	27	28	29
30	31					

1927 OCTOBER 1927						
SUN	MON	TUE	WED	THU	FRI	SAT
						1
2	3	4	5	6	7	8
9	10	11	12	13	14	15
16	17	18	19	20	21	22
23	24	25	26	27	28	29
30	31					

More than a quarter of a million Farrand Speakers sold in twelve months! . . . If you are not already a Farrand Dealer, you should be!

1927 MAY 1927						
SUN	MON	TUE	WED	THU	FRI	SAT
						1
2	3	4	5	6	7	8
9	10	11	12	13	14	15
16	17	18	19	20	21	22
23	24	25	26	27	28	29
30	31					

1927 JUNE 1927						
SUN	MON	TUE	WED	THU	FRI	SAT
						1
2	3	4	5	6	7	8
9	10	11	12	13	14	15
16	17	18	19	20	21	22
23	24	25	26	27	28	29
30	31					

Farrand Speaker

1927 NOVEMBER 1927						
SUN	MON	TUE	WED	THU	FRI	SAT
						1
2	3	4	5	6	7	8
9	10	11	12	13	14	15
16	17	18	19	20	21	22
23	24	25	26	27	28	29
30						

1927 DECEMBER 1927						
SUN	MON	TUE	WED	THU	FRI	SAT
						1
2	3	4	5	6	7	8
9	10	11	12	13	14	15
16	17	18	19	20	21	22
23	24	25	26	27	28	29
30	31					

They shield and save the finish



Atlas Plywood Packing Cases do more than that, too. They take radios as well as phonographs to the farthest points on the globe without the slightest damage to ANY of their delicate parts. Atlas Cases are strong, safe and sure. They are also mighty fine looking, which is a good advertisement for the shipper. And best of all, Atlas Packing Cases save freight and duty—they are so very light in weight.



PARK SQUARE BUILDING, BOSTON, MASS.

New York Office
90 West Broadway

Chicago Office
649 McCormick Building

419

Magnavox Co. Purchases Site for Large Plant Addition to Cost Over \$250,000

Deal Closed for Four-acre Tract in Industrial District of Emeryville, Cal., Adjoining Oakland—Plans Call for Immediate Erection of Structures With 100,000 Feet Floor Space

The Magnavox Co. announces the purchase of a four-acre site in the industrial district of Emeryville, Cal., adjoining Oakland. Plans are being made for immediate erection of buildings containing over 100,000 feet of floor space. The new factory will be of the most modern type, costing over \$250,000. The very latest machinery will be installed and advanced methods of production of radio tubes, loud speakers and receiving sets instituted.

"The continued success of Magnavox products," says F. M. Steers, president, "both in radio and electric heating devices, clearly warrants making this expansion. For some time our present facilities have been cramped. The growth of our tube department has been phenomenal. Likewise our business in loud speakers. The steady demand for Magnavox sets

indicates that next year will bring vastly more sales for our various models. More details of the new factory will be made public just as soon as they are determined."

Interesting Demonstration Plan Announced by Pathe

Will Send Sample of Any Pathephonic Instruments to Dealers to Permit Them to Make Satisfactory Demonstration

Realizing tone as the most distinguishing feature of the new type of talking machine, the Pathe Phonograph & Radio Corp., Brooklyn, N. Y., has adopted an interesting demonstration policy for its dealers. While the Pathe Co. has

issued an attractive catalog of the new Pathephonic line, it is announced in a recent letter to the trade that it will send a sample of any of these types of machines to the dealer for his inspection so that he can hear for himself the improvement that has been made in the art of phonographic reproduction.

Equal initiative is shown in the record department, which is featuring not only the Christmas numbers in the Pathe catalog, but also calling attention to a number of other records with a religious appeal which should be in demand during the Christmas season.

Plan 1927 Radio Show

The sixth annual Northwest Radio Show will be held in the new Minneapolis three-million-dollar auditorium in 1927. This was decided by the Northwest Radio Trade Association, sponsor of the event, at a regular meeting at the Nicollet Hotel, that city, last month. The week of September 26 to October 1 already has been reserved for the event through arrangements with the auditorium committee.

Sparton Distributors at the Sixth Annual Sparks-Withington Party



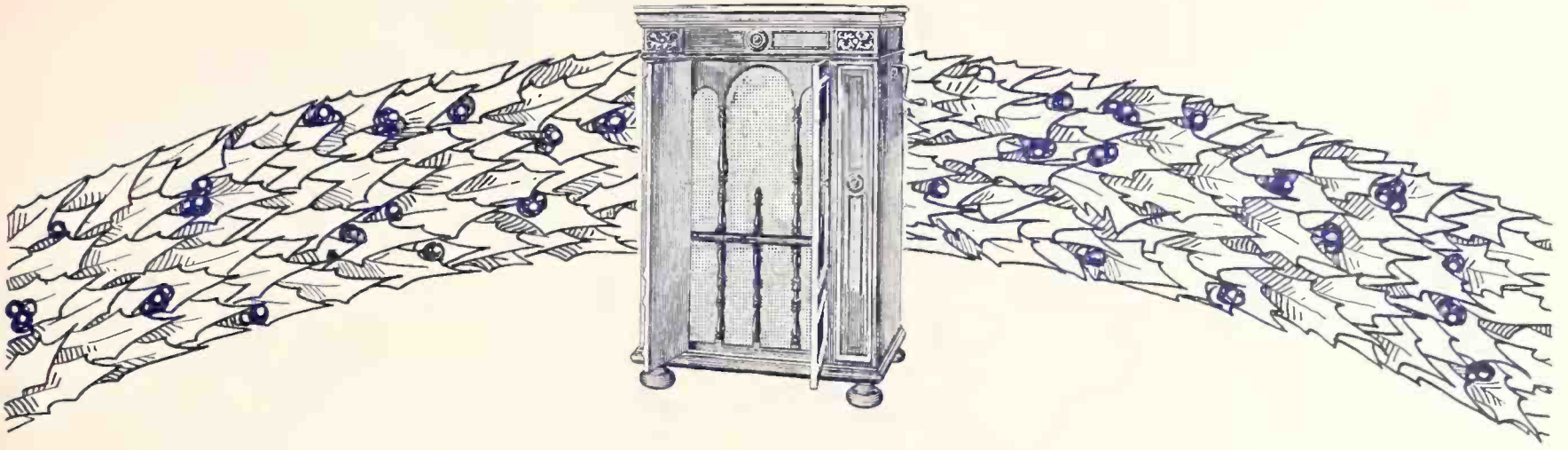

Another Year of Great Opportunity for VICTOR Dealers!

Victor dealers have ample cause for satisfaction with the year now drawing to its close. Phonograph and record sales have been remarkably good and will undoubtedly reach a climax during the current holiday season that will establish a new high level.

There is every reason to believe that this healthy condition will continue through 1927 and that another year of great opportunity lies ahead. Business is soundly prosperous, employment is steady and promises to continue so, and plenty of money is available for the purchase of luxuries.

Look ahead now and plan to get your full share of this potential business! And remember that dependable distributor connections will mean a great deal to you in the year to come. We have been rendering dependable service to Victor dealers for almost a quarter of a century and understand their problems as only a wholesaler of such long experience can.



Note
*New Phone
Number and
Increased Service*

Our telephone number has been changed to GRAMercy 5100—an easy one to remember. At the same time we have had installed ten consecutively numbered trunk lines—5100 to 5109—thereby assuring quicker connections at all times. Remember the new number

**GRAMercy
5100**

Blackman
TALKING MACHINE CO.
28-30 W. 23RD ST. NEW YORK N.Y.

VICTOR WHOLESALE DISTRIBUTORS

"BLACKMAN and DEPENDABILITY—One Suggests the Other"

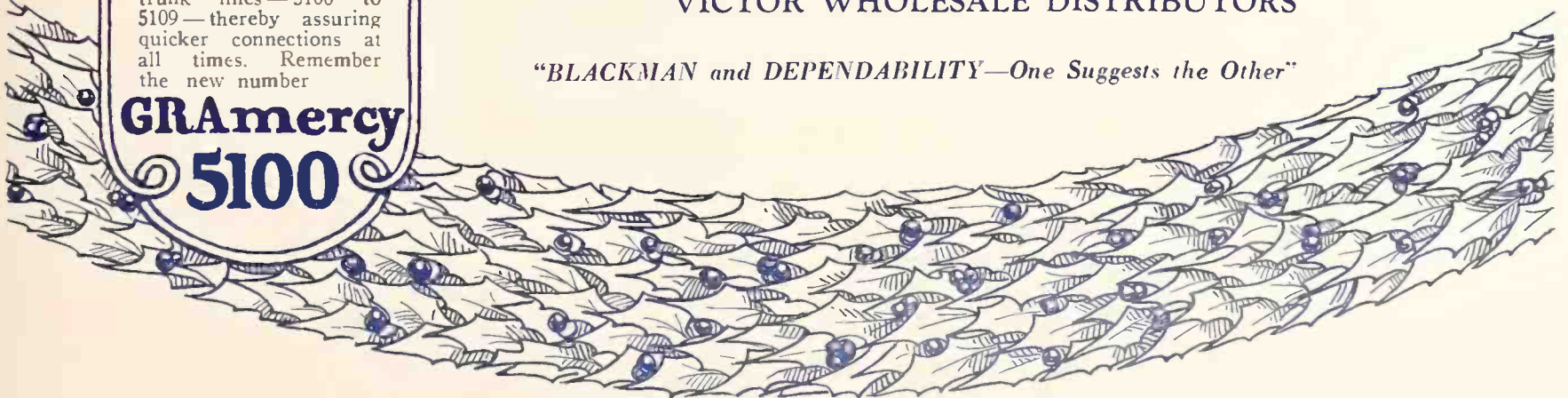

The Greatest Line of Portables Ever Offered to the Trade

KOMPACT
\$12.50

(For West and South add 10%)
(Canada, \$17.50)



Regal
\$15.00

(For West and South add 10%)
(Canada, \$25.00)



PAL DeLuxe
(For West and South
add 10%)
(Canada \$35.00)
\$25.00 Retail!

Assure yourself of getting all the Portable business in your territory by featuring the Pal, Regal and Kompact. You will then be able to fill the requirements of everyone of your customers—from those who want the best in portable phonographs, to those who prefer the lower priced machines.

PLAZA MUSIC COMPANY • NEW YORK, N. Y.

This MICRO-PHONIC Outfit actually changes an old style phonograph into a DEEP RICH TONE Instrument

This is the **BIGGEST** thing in a
phonograph accessory ever offered

Every owner of an old style phonograph will readily buy one of these Micro-Phonic Outfits. By merely substituting it on their own phonographs, they can get that deep rich tone of the new high-priced models.

DISTRIBUTORS

Wide Awake jobbers can cash in on the big demand for these Micro-Phonic Outfits. Write today.

End Your Trade-in Worries

This Micro-Phonic Outfit is the solution to your trade-in worries. Equip the machines you trade in with the Micro-Phonic Outfit and you will find a ready market for them.

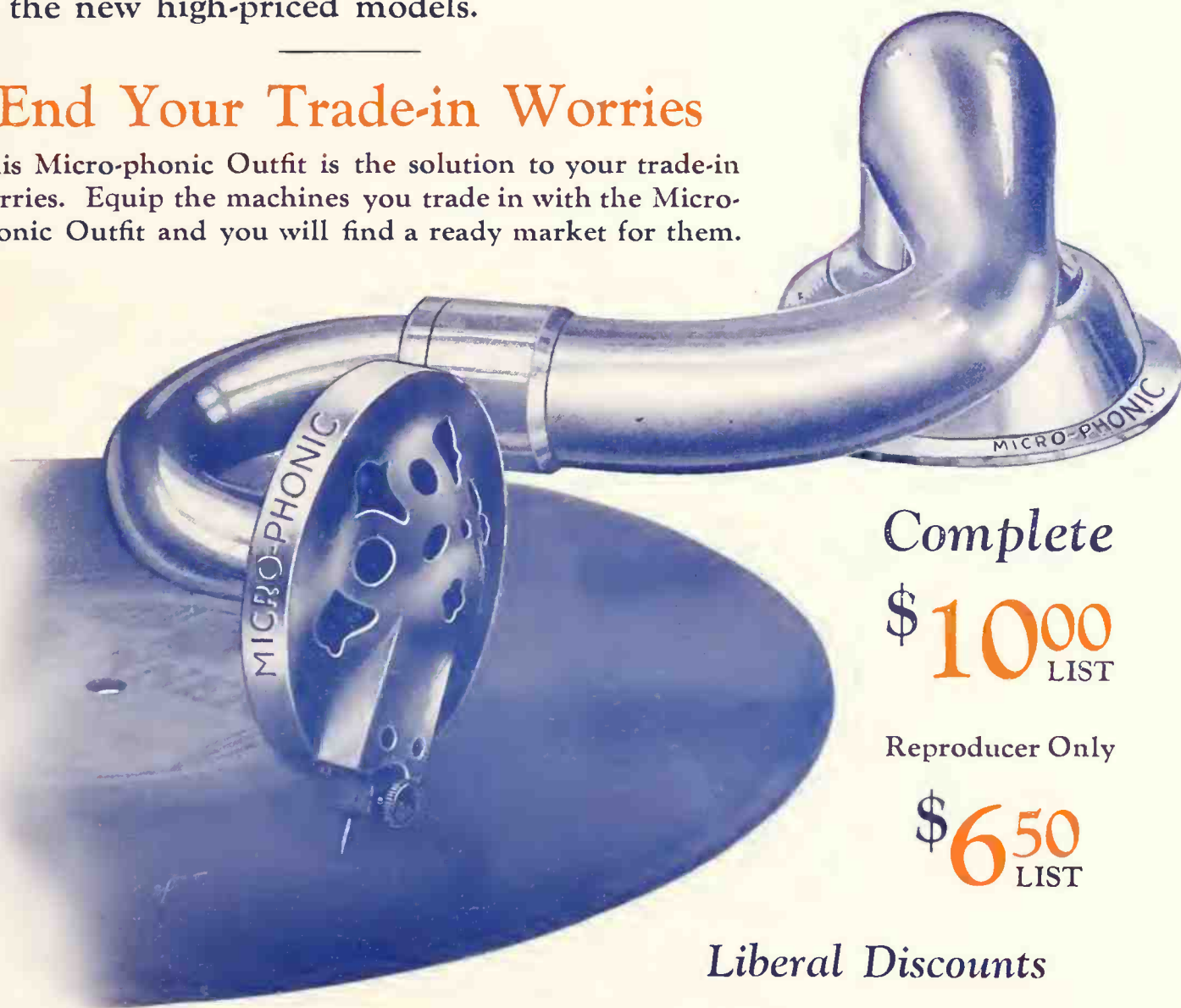

Complete

\$ **10⁰⁰**
LIST

Reproducer Only

\$ **6⁵⁰**
LIST

Liberal Discounts

ADVERTISING HELPS—An attractive display card together with a complete advertising service of window strips, circulars, newspaper mats, etc., is supplied free to all Micro-Phonic dealers.

Plaza Music Company, New York, N. Y.

SLEEPER

OFFERS A CHRISTMAS CONSOLE MODEL
for IMMEDIATE EXPRESS DELIVERY



*A*N exclusive design of finest craftsmanship. An exquisite console of rare grace and beauty built around a radio set that music lovers have approved as the superb musical instrument of radio.

Two controls, calibrated in wave lengths, five tubes giving two stages of tuned radio, detector, and two stages of audio amplification with output transformer.

The Sleeper console provides a big tone chamber acoustically correct equipped with the new adjustable Amplion unit; ample space is provided for heavy duty batteries and provision is also made for the use of electric power devices to run the set from the lighting current.

*Price of this console complete except for
batteries and tubes: \$225.00 f. o. b. New York*

The Sleeper chassis especially designed for console installation is also available separately. Immediate delivery. Prices quoted upon request. Size of panel 22 by 9 inches.

Sleeper Radio & Mfg. Corporation

GORDON C. SLEEPER, President

6th and Washington Aves.

Long Island City, N. Y.

Salesmanship in the Record Department Essential to Its Profitable Operation

Selling Records Demands Complete Knowledge of the Catalog—J. F. Brogan Studies His Products—How He Cashes in on Knowing the Contents of the Record Catalog

At a recent meeting in New York of a talking machine dealers' association one of the speakers, a distributor's representative, laid stress on the fact that the record departments of a great many dealers are being neglected, being under the direction of incompetent and careless clerks who merely take orders from customers without any real knowledge of the product they are handling. There is another type of dealer, however, who realizes that the record department is an important one, and who gives as much attention to his stock of records as he does to the instruments on the floor, and chooses his record sales staff with as much care as he does the men who are to sell the talking machines. He realizes that every person who purchases a talking machine is a potential repeat buyer and the purchases of records in the future, if properly handled, will in many cases equal if not exceed the purchase price of the instrument.

Knowledge of Catalog Essential

The salesmen are selling talking machines and records, it is true, but these products represent music, and the salesmen, to secure the best results, should be able to converse intelligently on the subject of music. It is not meant that every record salesman should be a trained musician, conversant with musical terms and expressions, but he should know the catalog and the records represented in it, to an extent that when an opera is mentioned he can select the principal selections of that opera without recourse to the catalog. He should have at his finger tips the outstanding artists of the present day and the records they have made. If a customer expresses a desire for a certain type of record he should be able to offer recordings with a similar appeal.

Real Salesmanship

Such a record salesman is J. F. Brogan, manager of the branch store of the New York Band Instrument Co., New York, who, through his wide knowledge of recorded music, recently completed a cash sale for a \$550 talking machine and with it records totaling in price \$377. The customer who entered the store was interested in the Orthophonic Victrola and had no intention of purchasing the library of records with which he finally became possessed, but, having decided to buy the instrument, he asked Mr. Brogan's assistance in selecting some records. The customer was musically inclined, being in fact a musician, and in Mr. Brogan he found a kindred spirit. The Columbia series of Masterworks were the first items Mr. Brogan demonstrated and the customer was so astonished at the high standard of these recordings and Mr. Brogan was so well qualified in describing and explaining the recordings that he sold the entire series of forty-one Columbia Masterworks albums, costing \$260. Not content with this he explained the Victor series of album sets and was successful in selling the entire series, together with other single records, bringing the total record sale to \$377. In passing, it might be mentioned that the customer had with him a friend who, in listening to Mr. Brogan's sales talk, became interested and finally purchased a \$300 instrument and between \$75 and \$80 worth of records, making the total transaction about \$1,300, all of which was paid in cash.

This was accomplished by salesmanship. While sales totals of the amount mentioned for a single transaction are unusual, this salesman has built up for himself a clientele which visits his store from all sections of the city because of his ability to aid them in intelligently selecting records.

Recently the wife of a prominent artist of the Metropolitan Opera Co. visited the store and stated that she had been recommended to it by

a friend. She purchased in the neighborhood of fifteen dollars' worth of records on her first visit and before leaving gave Mr. Brogan a list of the names and addresses of several friends who she felt sure would appreciate the sending of the latest record releases.

Selling Album Sets

With the album sets of records assuming a more important part in the record stocks of live dealers, the record department needs more than ever competent direction and management to secure from it the profits which this section of the store should bring in. As these sets have a list price ranging from five to almost fifteen dollars, they represent a portion of stock which should be given attention. The larger companies are featuring these products in news-

paper advertisements and in the programs of musical events. The manufacturers are doing their share; it remains for the dealer to prepare himself to cash in on the market that is being ripened.

Sheppard Co. in New Home

SAVANNAH, GA., December 6.—The formal opening of the new home of the B. J. Sheppard Co., music dealer, took place November 23 with elaborate and appropriate ceremonies. The three-story building at 220 Broughton street, West, was attractively decorated and from ten in the morning until nine at night a musical program was provided and souvenirs were distributed to visitors. This establishment, which has been in existence for about twenty years, carries a complete line of Victor Orthophonic talking machines, Buescher band instruments, pianos and other musical instruments.

B. Goldman, Inc., Ocala, Fla., reports a big business in Victor Orthophonics and records.

POCKET PHONOGRAPH

Mikiphone
VADASZ SYSTEM

AN ORCHESTRA IN YOUR POCKET

SIZE:

Diameter, 4½ in.
Height 1¾ in.
Weight 2¾ lbs.

Guaranteed to play a full ten-inch record with one winding

Retail Price:

\$15

Liberal Trade Discounts



CLOSED



PLAYING

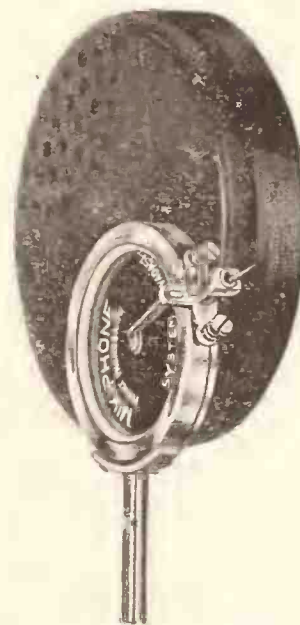

SOUND AMPLIFIER

Jobbers Wanted!

MIKIPHONE S. A. Inc.

44 Whitehall Street

New York

Get the whole range of Christmas sales

- with the *complete* line of Radiolas



Sell to the man who wants the finest radio—at a moderate price.

Radiola 20, list, \$115

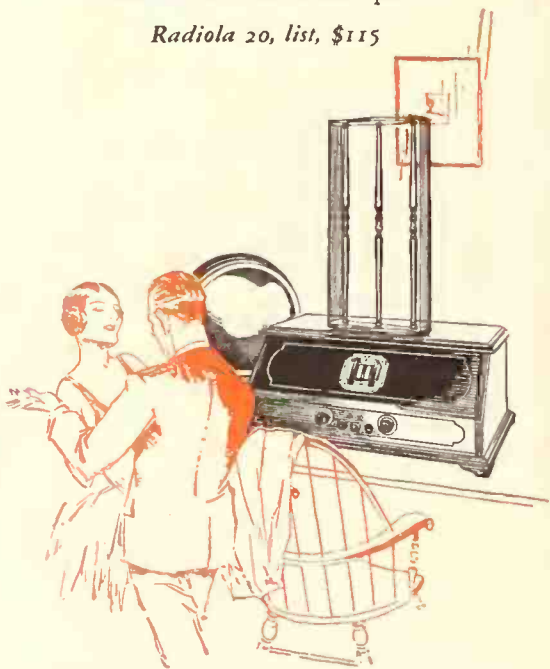

Sell to the man who wants the superlative quality of the super-heterodyne.

Radiola 25, list, \$165



This sign marks the leading dealer in every community.

DON'T let a single sale go by! With the complete line of RCA Radiolas, and the Radiola Time Payment Plan to back him up, the RCA Authorized Dealer can sell to every radio prospect... from the man who can buy only the smallest model "on time"... to the man who can pay cash for the finest of all.

RCA dealers themselves predict that this will be their greatest year. Sales are rising to a new peak, for the public has absolute confidence in the *tried, tested and perfected* Radiolas. The public knows that they will continue to perform as they do on demonstration—superbly!



Radiola 26, list, \$225

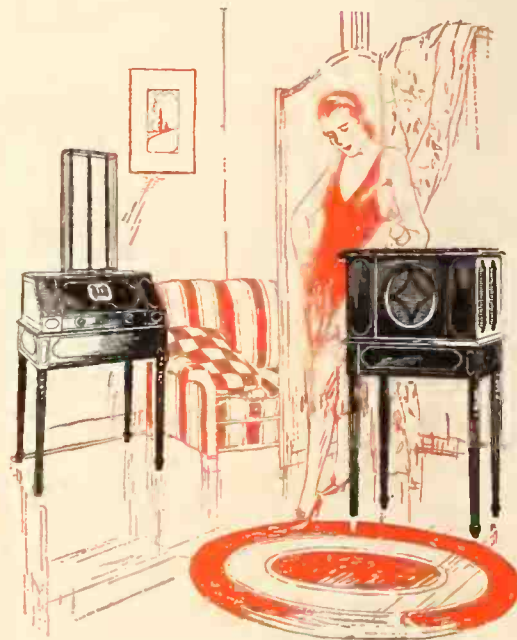

Sell to the man who wants lighting socket radio.

Radiola 28, list, \$260. RCA Loudspeaker 104, list, \$275. A.C. Package, for adapting Radiola 28 for use with Loudspeaker 104, without batteries, list, \$35.

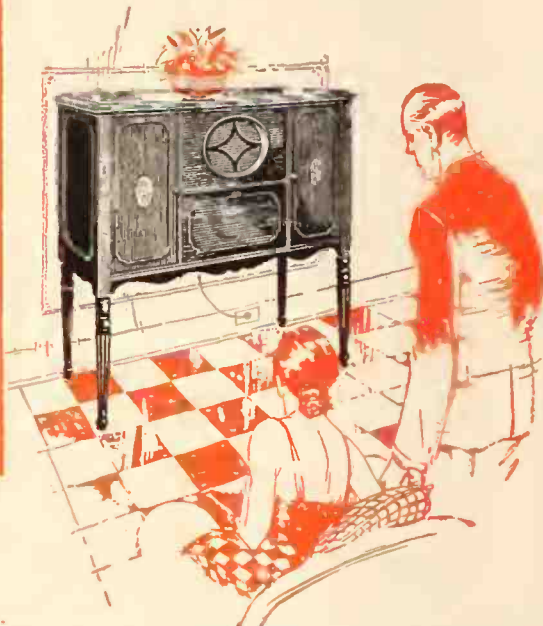

Sell to the man who wants the great electrical and musical achievement of the Radiola 30.

Radiola 30, list, \$575

RCA Radiola

MADE · BY · THE · MAKERS · OF · THE · RADIOTRON

RADIO · CORPORATION · OF · AMERICA · NEW YORK · CHICAGO · SAN FRANCISCO



look inside that Christmas Radio Set

THE equipment is as important as the set. The distance reach of a set depends a great deal on the tube in the detector socket. The overall performance of a set depends very much on the tubes in every socket. The volume and tone quality you will get are dependent upon the tube in the last audio important as the set. And everyone who realizes this insists on genuine RCA Radiotrons.

Extra! Extra! Gift Ideas for Radio fans

A spare Radiotron—genuine RCA Radiotron, of course—of the type he uses

A spare Radiotron UX-171 or UX-210 for bigger volume and finer tone

A special Detector Radiotron UX-200-A for longer distance reach

Ask any dealer all about these Radiotrons—he'll tell you which to get. But be sure it's a genuine RCA Radiotron, it is so worthy of gift giving

RADIO CORPORATION OF AMERICA
New York Chicago San Francisco

RCA Radiotron
MADE BY THE MAKERS OF THE RADIOLA

Every Christmas Shopper is a prospect for Radiotron sales

1. for the set he has
2. for the set he buys
3. for gift-giving

Every Christmas shopper knows Radiotron quality and reads Radiotron adshe can't miss them

RCA Radiotrons are the year-round bread-and-butter business of the reliable radio dealer. And practically every Radiotron in the list is a big Christmas seller.



RADIO CORPORATION OF AMERICA
New York Chicago San Francisco



RCA Radiotron

MADE BY THE MAKERS OF THE RADIOLA

Opportunity for Trade to Tie Up With National Drive of Piano Manufacturers

Association Plans Expenditure of Over Quarter of Million Dollars Annually for Three Years to Promote Interest in the Piano—How the Trade Can Tie Up

Beginning with the first of the year the piano trade of the country, and most directly the National Piano Manufacturers' Association in co-operation with the retailers, will launch a nation-wide campaign to arouse more general public interest in the piano for the home. Funds of over a quarter of a million dollars annually for three years have been appropriated for the purpose and the program is one that should serve to bring desired results in a considerable measure at least. The program includes a campaign to promote the teaching of piano playing in the elementary and high schools of the country under the group plan and the holding of local and national piano-playing contests, all of which may appear foreign to the talking machine trade, but which, nevertheless, can be taken advantage of profitably by the talking machine dealer who keeps in touch with what is going on in his own particular locality.

We hear a great deal of the place that has been filled by the talking machine in the field of education and have witnessed the excellent use of phonographs and records in the various schools of the country; yet few dealers have apparently realized the possibilities of the talking machine record in providing expert instruction in the personal playing of the piano or other musical instruments. As a matter of fact, we hear of artists who have declared that they have been able to improve their methods by studying the records made by themselves and other artists of standing. We find also pianists who by a close study of the recordings by the masters of that instrument have been able to improve noticeably their interpretative work.

The phonograph dealer who keeps in touch with the exploitation work being done for the piano, particularly in group instruction, can undoubtedly profit by calling the attention of the pupils, at least those who have advanced to a certain degree, to the advisability of listening to the records of noted pianists in order to gain a proper appreciation of tempo, dynamics and expert expression generally. On the face of it it may seem a little far-fetched. Only recently at a public entertainment a young lady, in responding to the applause brought forth by her pianistic ability, declared that she owed the excellence of her interpretation to the study of records of the same numbers made by noted piano virtuosi.

The phonograph record will not teach piano playing, nor will it teach the playing of the saxophone or the violin, and the elementary work must be done along the old lines, with

proper instruction and faithful practice. With the ability to sound the proper notes and chords, however, there comes the demand for intelligent fingering and the correct use of the pedals. In short, for capable expression. For this purpose the records provide the example of the master. They may be repeated time and time again without bringing forth the slightest indication of impatience or fatigue. Patient practice in following the record will result inevitably in a better rendition by the budding artist.

It is significant that the makers of music rolls for reproducing pianos have already sensed the possibilities for providing instruction through the medium of the recordings by leading pianists on the rolls. In some cases these

E. S. Applegate & Co. Feature Mohawk Line

Trenton, N. J., Concern Conducting Successful Newspaper Advertising Campaign in the Interest of the One-Dial Radio Receiver

TRENTON, N. J., December 6.—E. S. Applegate & Co., 17 South Broad street, this city, have been conducting a most successful newspaper campaign featuring Mohawk one-dial radio receivers. This newspaper advertising has been appearing in the Trenton Evening Times and the originality of the campaign has been one of the most important features in its success. Dan Egan, general manager of the company, who is responsible for the sales and advertising policies of E. S. Applegate & Co., has been congratulated upon the use of newspaper advertising which has not only produced direct results, but which is quality publicity of the highest degree.

When the campaign was inaugurated Mr. Egan arranged for preferred space in the newspaper, whereby the Mohawk advertising would appear on page three, which is recognized as one of the most desirable positions in newspaper advertising. Before the basic display copy appeared, sixteen-inch advertisements were used on page three to advise the newspaper readers that a special radio announcement would appear on that particular page within a few days. This method of attracting attention to the campaign was used for several days when the advertising itself was presented to the public. The Mohawk one-dial receiver was illustrated to splendid advantage and the distinctive features of the product were presented so effectively that the number of sales and prospects received were far beyond all expectations.

recordings are so arranged that the artist plays the treble while the student plays the bass, and then the process is reversed. When the ensemble is worth listening to then the progress of the pupil is improving. Phonograph record manufacturers have not yet progressed to this point in their instruction work, but they do make it possible for the young pianist to study the interpretations of a number of prominent pianists at close range and with as frequent repetitions as are necessary and desirable.

As the campaign for the promotion of the piano develops throughout the country, some wise phonograph dealers are going to seize this opportunity for effective tie-up and take advantage of it. It will probably bring no overpowering volume of business direct, but it assuredly will bring some if properly handled and will result in a close tie-up with the musical people in the dealer's particular territory. That is publicity of extreme effectiveness and it can be utilized in other directions in promoting the dealer's sales.

Radio Corporation Dealers Hold Meeting in Portland

Great Gathering of Northwestern Dealers Hear Addresses by Men Prominent in Field

PORTLAND, ORE., November 23.—The representative retail and service dealers of the Radio Corporation of America held a meeting in this city recently. During the afternoon a business meeting was held with a banquet to discuss service and a sales campaign for the current year. The meeting was called by George A. Boring, manager of the Pacific States Electric Co., in co-operation with a transient number of representatives from the San Francisco headquarters, including among others Herbert M. Hucke, service specialist; N. A. Woodford, radio trade specialist; and G. Harold Porter, manager of the Pacific division. J. R. Bullock, district advertising manager, was also in attendance. Discussion was centered during the afternoon in a general coverage of radio service and retail distribution. Mr. Hucke covered the various procedures in efficient servicing not only in their line, but all types of receiving equipment as well. The three speakers covered the service subject at the banquet. Mr. Bullock devoted his talk to advertising. Mr. Woodford's subject was "Radiotrons," and Mr. Porter, Pacific division manager, gave an outline of the development of the establishment of the Radio Corporation of America and spoke of the developments in the radio industry.

The Charmaphone Co., Pulaski, N. Y., manufacturer of phonographs and radio cabinets, recently enlarged its plant. Increased business made expansion necessary.

The BOSCH combination—

The Armored Radio, the Ambotone and the Nobatry together make, not only radio perfection, but in addition keep your customers happy and your bank deposits healthy.

ARMORED RADIO — AMBOTONE — NOBATRY

WEBER RANCE CORP.

In Brooklyn
1271 Bedford Ave.

Sole Metropolitan Distributors
Circle 7610

In New York
225 West 57th St.

B O S C H

REPRODUCER

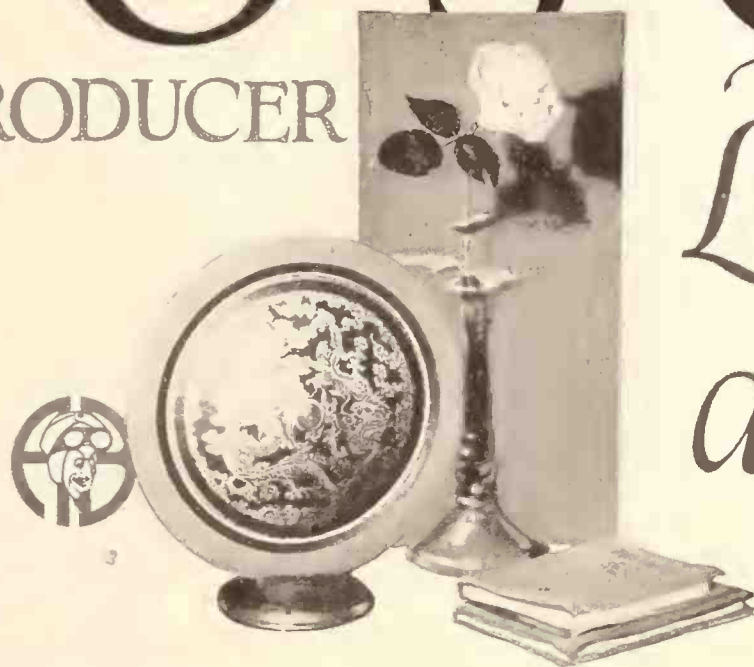

*New
Library
Model
Ambotone*
\$ **12** **50**

The newest Bosch Radio achievement—a quality reproducer at \$12.50. Mellow and free from metallic sound, a reproducer that will sell easily and in great volume. The new Bosch Library model reproducer is distinctive. Its entire cone disk is gold, ornamented with a wide plain gold circular frame. Tastefully decorated in the oriental motif and so pleasing is the black and gold combination that it becomes a note of furnishing in any home. It is the ideal guest room or “extra” radio reproducer. The Library Ambotone may be had at the same price in either the table model or the medallion which with its gold color silken cord hangs upon the wall. The Bosch Library model reproducer is ready for immediate deliveries.

The New Library Ambotone—Table Type or Medallion—\$12.50

NOBATTERY “B” POWER UNIT

The famous Bosch Nobattery “B” power Unit answers every demand for a dependable, long lived, lighting socket power



attachment that will give silent and unvarying “B” power. The Nobattery is entirely automatic, mistake proof, it cannot burn out tubes of the radio receiver. It pleases customers because it

requires no adjustment, is without hum; nothing to fill or spill. Designed for personal and mechanical safety and adequate

for any set up to 10 tubes including power tube. Its voltage ranges from 90 to 135. You can feature the Bosch Nobattery with perfect safety. Ed 3 for Alternating Current \$48—Direct \$42

All prices slightly higher Colorado and West and in Canada

AMERICAN BOSCH MAGNETO CORPORATION

MAIN OFFICE AND WORKS: SPRINGFIELD, MASS., BRANCHES: NEW YORK, CHICAGO, DETROIT, SAN FRANCISCO

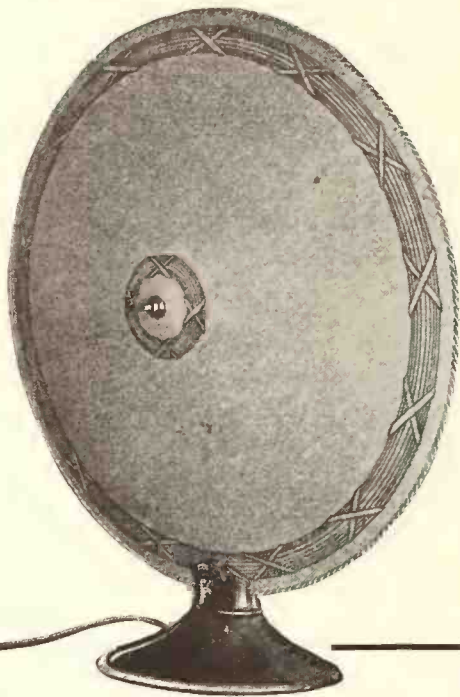

Licensed under Lektophone Patents

Popularity and Profits

THE excellent performance, artistic appearance, popular price and national advertising are real, sound reasons why every good dealer should immediately stock and sell

**"The Speaker of
the House"**

THE PACENT CONE

THE almost over-night public acceptance of the Patent Cone has attracted the full attention of the progressive dealers everywhere to make it their business not to overlook any merchandise for which there is public interest and demand.

Type A (table type), 17 inches in diameter, with bronze-finished base, cord and Patent detachable plug.

List Price \$28.50
(\$31.50 West of Rockies)

ALSO made in 36 inch size for either floor or wall mounting. Full information and prices will be sent on request—prices ranging from \$78.50 to \$89.50.

Write for special dealer proposition on this quick-selling product, and for "advertising helps."

**Patent
Radio Corporation**

156 West 16th Street New York City

L. W. James in New Post With Federal Radio Corp.

Former Assistant Sales Manager Now Assistant to President—E. S. Hilber Promoted to Position Vacated by Mr. James

The Federal Radio Corp., Buffalo, N. Y., has announced the appointment of L. W. James, formerly assistant sales manager, to the position of assistant to the president. Mr. James is a very well-known figure in the sales division of radio, having been intimately connected with Federal's field organization for nearly five years. After a period of managership in the Kansas City Federal branch, and several months as special representative, he was recalled in the Fall of 1925 to take over the duties of assistant sales manager at the factory. Mr. James has been succeeded as sales manager by Ernest S. Hilber, who for three years has been sales manager of Federal radio parts in the metropolitan district, and was then made special representative to wholesalers in the United States and Canada.

Panatrope Furnishes Music for Jackson County Fair

PORTLAND, ORE., December 6.—The Brunswick Panatrope did yeoman service at the annual Jackson County Fair, as is attested in the following excerpt from a letter to the local office of the Brunswick Co. from the secretary of the Fair. It reads: "I wish to take this means to express for myself and my Board of Directors our sincere thanks and deep appreciation for the fine music furnished by your Panatrope in the various buildings during our recent Fair. There was a wire put into the following buildings: Horticultural, Forestry, Automobile and Women's, with loud speakers attached and controlled by a main instrument placed in the Weeks & Orr's booth in the Merchant's Building, and it was done in such a manner and we were given such a volume of music that I did away with the usual orchestras which I used in these various buildings, thereby saving a good many dollars."

Crosley Has Developed a Tremendous Industry

Within the brief span of a few years, radio, as a manufacturing industry, has leaped to front rank among the industries employing factory workers in Cincinnati. The Crosley Radio Corp. has attained this position. More than 2,300 people work directly for the Crosley Corp. in the Crosley factories. Many thousands more are employed in outside factories in Cincinnati and other sections turning out wire and punch pressed products as well as thousands of fine cabinets each day. The Crosley Corp. itself manages to produce 1,500 cabinets daily. But to bridge the gap it must go outside for additional thousands. Production approximates 6,000 sets each day.

Open Sales Office in Chicago

LA GRANGE, ILL., December 7.—The Producer Manufacturing Co., maker of phonograph apparatus, a newly organized corporation, has made its headquarters at 819 Hillgrove avenue. The sales offices are located in the Railway Exchange Building, Chicago.

Praises Carryola Portable

The Carryola Co. of America recently received a communication giving high praise to the Carryola Master portable talking machine from a proud possessor of this instrument. The writer is a traveling man and he extols the instrument as a boon for those on the road.

Harry A. Beach Now Sales Manager Chas. Freshman Co.

Nationally Known Executive Joins Forces of New York Radio Manufacturer in an Important Capacity—Is Widely Experienced

An announcement of nation-wide interest to the music-radio industry was the appointment of Harry A. Beach as sales manager of the Chas. Freshman Co., New York, manufacturer of Freshman Masterpiece receivers and accessories. The official announcement was made by Myron Goldsoll, vice-president of the Freshman Co., who stated the directors of the company had decided that the sales managership required the services of an executive who was not only widely experienced in the merchandising of a nationally advertised product of merit, but one



Harry A. Beach

who was fully conversant with the Freshman plan of doing business exclusively through franchised dealers and who believed implicitly in the soundness of such merchandising efforts.

Mr. Goldsoll said that Mr. Beach had spent several weeks in close association with Mr. Freshman and himself, as well as other officials and executives of the Freshman organization, studying production and distribution methods of the company.

"As sales manager of the Chas. Freshman Co., Mr. Beach has a most interesting position," said Mr. Goldsoll. "He comes to a company that is daily growing stronger, operating on a unique sales plan which is highly successful and which he is asked to further develop, but which in principle will not be changed in any way. Mr. Beach is in sympathy with our methods and is a straight-thinking executive. All of the officials of our company are solidly behind Mr. Beach and we know that our dealers will extend to him their full co-operation.

"We always have on hand an accumulation of applications for the Freshman franchise that we desire to handle with fairness to our well-established dealers. Good merchants, old-time music stores and other worthy concerns are not in the habit of being refused the purchase of materials that they desire to handle. They justly think that a manufacturer should be complimented by their application. Consequently, we sought as sales manager a man of fine diplomacy and keen judgment, and we believe Mr. Beach is that executive."

For sixteen years Harry A. Beach has been a widely known figure in the music industry. He joined the Victor Talking Machine Co. in 1910, becoming in time manager of all the traveling representatives of that company. He resigned in 1921 to become vice-president and general sales manager of the Unit Construction Co., Philadelphia. In 1923 he was appointed Eastern sales manager of the phonograph division of the Brunswick-Balke-Collender Co., resigning some months ago.



The Fulfillment of an Ideal

THE individual or the institution without ideals soon loses the stimulus of inspiration . . . and the satisfaction which comes from making others happy.

The Brunswick Company, its dealer organization and their respective employees, and the great electrical institutions that have collaborated, may all look back upon 1926 with a feeling of just pride.

This has been an epoch-making year.

The whole world has been made happier through the combined efforts of all of us who have together successfully introduced and marketed the World's First Purely Electrical Reproducing Musical Instrument—

The BRUNSWICK PANATROPE

THE BRUNSWICK-BALKE-COLLENDER CO., GENERAL OFFICES: CHICAGO

Featuring the MUSICAL POSSIBILITIES of the TALKING MACHINE

[EDITOR'S NOTE—This is the sixty-third of a series of articles by William Braid White devoted to the various interesting opportunities which prevail in the domain of education for the retailer of talking machines. The subject is one of great interest and we commend these articles to the consideration of all who are devoting attention to the featuring and developing of the musical possibilities of the talking machine.]

Why Not Phono. Societies?

Some months ago, and, in fact, quite by accident, my attention was directed to a movement in the talking machine realm which has become very influential across the water. It seems that about three years ago Compton McKenzie, the famous novelist, who is an amateur expert in matters phonographic, took the very bold step of publishing a magazine entirely devoted to the interests, not of the trade, but of the buyers of talking machines and records. He said that he thought there were enough of these latter to give him the circulation he would need, and for their benefit he proposed to bring out each month a musical amateur's paper, devoted to the phonograph, in which everything pertaining to machines, recordings, reproduction, music, etc., should be discussed by experts for the benefit of the thousands of music lovers all over the world who are getting the better part of their musical pabulum through these media. At or about the same time there was organized in London, under his direction likewise, a private recording society which was named the National Gramophonic Society, and the aim of which was to be to record for subscribing members only, and at cost, musical works which were not, and were not likely to be, recorded by the regular recording companies. The two enterprises, mutually supporting, have now been running nearly three years and they have gone on steadily increasing in influence and in numbers.

Working the Localities

Along with the activities of the National Gramophonic Society in producing recorded music not otherwise likely to be obtainable, it appears that local societies are being organized from time to time among talking machine enthusiasts under the same general auspices. These societies consist of groups of men and

women interested in music who possess phonographs and records, and who meet at each other's homes or elsewhere at regular intervals for the purpose of giving concerts of phonograph music and of discussing and criticizing the music to which they listen. From the appearance of the reports I judge that there must be dozens of these societies throughout Great Britain to-day. It is hardly necessary to point out that all this is helping along the sale of machines and of records. Every reader of The Talking Machine World is aware of the marvelous strides into great prosperity which the British end of the Columbia Co. interests has made during the last three years. And it is at least significant that the Columbia interests have been among the best, perhaps indeed the actual best, supporters of the magazines I have mentioned.

Well, Why Not Here?

Now, seriously, is there any reason why something like this should not be done in the United States? As a matter of fact a Boston group has already started the publication of a magazine called The Phonograph, modeled upon The Gramophone, and already some local societies are being organized. But apart from that, apart even from the question of a private recording society which is not yet probably to be considered as a "live" topic in this country (much as one might wish it were), why do not phonograph dealers investigate this question of amateur societies of phonograph enthusiasts? Of course, the first reply will be that conditions are different in the United States. Conditions, whatever they may be, are doubtless "different," but that means absolutely nothing. There are plenty of phonograph enthusiasts to be found in the United States. There are also millions of phonograph records to be sold, but real promotion is needed.

What Actually Happened

I had occasion recently to get in touch with phonograph enthusiasts located at points East, West, North and South. These people must one and all have been in so close touch with events abroad as to have heard of the new movement. Now if such enthusiasts have al-

ready made themselves known, it is a safe bet that in every community are the materials of a similar group which only need to be sought in order to be discovered.

I know that this is true because only recently the same thing has happened at home. I thought it would be interesting to see whether in Chicago there were any men and women like-minded with myself. And without half trying I found plenty of them. There has not been the least difficulty in forming a casual circle on the same general principles as govern these amateur groups across the Atlantic. And the results so far have been most thoroughly worth while.

Away From Flapperdom

Now the point is simply that what is true of my own experiences is true elsewhere. Almost any community contains at least some men and women who are interested in the musical aspects of the talking machine, who possess machines and who have acquired greater or smaller collections of records. Without half trying I have learned of such men and women, all over the big city of Chicago, men and women mostly of mature age and taste, with good common sense and more or less of culture, people who are not satisfied with the banalities of flapper life and who are only too anxious to learn all that can be learned of the recent discoveries and achievements in the phonograph world which are remaking the whole industry and putting it on a new scientific and musical basis. Every one of these is a present or potential buyer of records. And that means a buyer in quantities, not a buyer of one record a month, but of as many as income will allow. In the talking machine industry, as in that of virtually every stable and permanent line, the older people do the buying. The youngsters may have a lot to say during the purchase and their wishes are always consulted, but they do not put up the money. Neither do they get the real good use out of the machines. It is the fathers and mothers who, once they are educated up to what the talking machine can give them in the way of entertainment, become the best buyers of records.

For the Merchant

Which is why I have spoken of this idea of forming groups of phonograph enthusiasts in all communities. Here is something for the merchant to do, something which will not only bring together many most charming and interesting people, tired of the eternal bridge clubs, but will also stimulate trade in high-class, high-priced records as nothing else can.

It all comes back to the old story: that if you want to make the phonograph the big thing in your community that it ought to be, you must feature its musical possibilities, which are still strange to millions. The dealer still has virgin territory all around him waiting to be tilled. It only requires a little imagination to visualize the possibilities, and a little determination, backed by courage, to make these bear fruit a hundredfold.

Northwest Association Endorses White Bill

The Northwest Radio Trade Association has endorsed the White Bill, now before Congress, going on record as being opposed to the Dill Bill, claiming that the White Bill is in reality an outgrowth of the conferences by the entire radio industry which have been held for the last three or four years, and that the Dill Bill is merely a substitute by the Senate in order to try to secure control of the radio situation through the medium of a commission.

The Tube of Longer Life

C.E.C.
TRADE MARK REGISTERED U.S. PAT. OFF.

Radio Vacuum
Best by Test
TUBES

Make a Good Receiver Better!

Write for Complete Data and Prices

C. E. MFG. CO., INC., Providence, R. I. Largest Plant in World Making Tubes Exclusively

Empire Universal Tone Arms and Reproducers

"The STANDARD of the INDUSTRY"

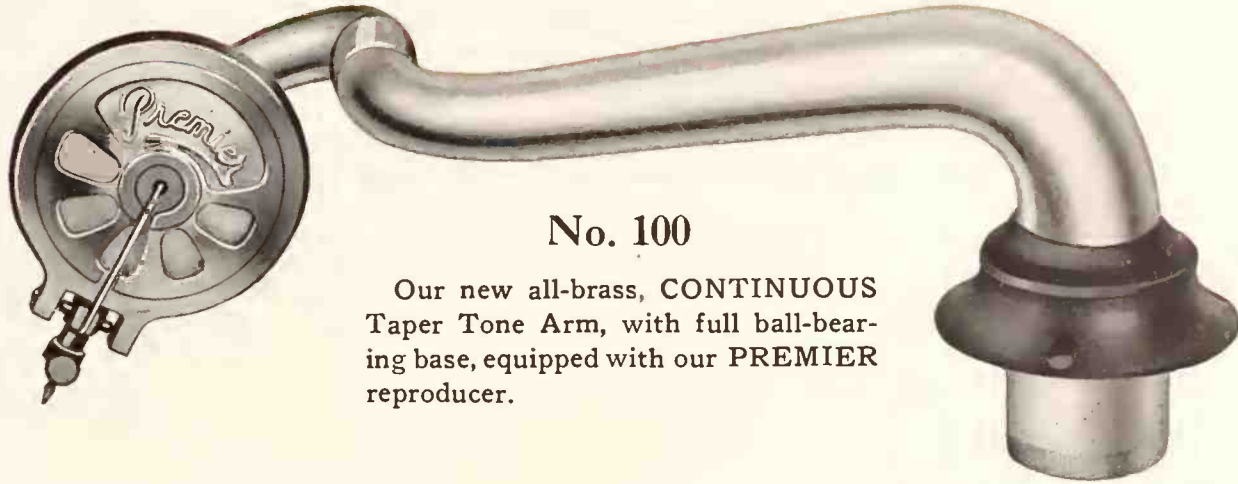

No. 100

Our new all-brass, CONTINUOUS Taper Tone Arm, with full ball-bearing base, equipped with our PREMIER reproducer.

Specifications:

Height from motor board to top of tone arm is $3\frac{1}{8}$ inches. Inside diameter at base is $1\frac{13}{32}$ inches. Outside diameter of base flange is $2\frac{7}{8}$ inches. Length from turntable center to center of horn hole on motor board is $9\frac{1}{2}$ inches.

It is now a recognized fact that there are three things necessary to obtain the best results from the new electrically cut records. These are the reproducer, a CONTINUOUS taper tone arm and the long amplifying chamber.

The unit illustrated above, when used with a long amplifying chamber, embodies these points, and has been scientifically designed to meet the latest achievements in the science of acoustics.

LIST PRICES

Tone Arm Only

Nickel	\$ 7.50
Oxidized	8.00
Gold	8.50

Complete as Shown

Nickel	\$12.50
Oxidized	13.00
Gold	13.50

Order sample, test it out. It will win you on its merits.

Empire Tone Arms Are Used by Carryola

THE EMPIRE PHONO PARTS CO.

10316 Madison Avenue, Cleveland, Ohio

Established in 1914

W. J. McNAMARA, President

A New Orthophonic-Type Reproducer

With twenty-eight years' experience in the phonograph industry, we believe we can help you solve your reproducer problems.

The Carryola Company of America says:

"Out of all reproducers available, Carryola picked **ADD-A-TONE** as standard equipment on all Carryola models."

"**ADD-A-TONE** helped. **ADD-A-TONE** is an essential part of Carryola success. No other make achieves such clear, accurate, full reproduction. No other make was good enough for Carryola, a company that demands the best."

Our special proposition will interest you

UNIQUE REPRODUCTION CO.

32 UNION SQUARE

NEW YORK



A Christmas Message to our Friends and "Friendly Enemies"

AT this time of the year, with Christmas thoughts in our hearts and the profits of our most successful year in our pockets, we have a message to broadcast.

To all Carryola Jobbers and Dealers—our business friends who have contributed their part in making this prosperity possible—we extend the Greetings of the Season, the hope that they have prospered in full measure with us, and the firm belief that 1927 will be a bigger year in which they will experience still greater benefits.

To our "Friendly Enemies," which means our competitors, we wish also the Greetings of the Season, offered in the best spirit and with real good-will. We wish them all prosperity in 1927, believing that there is room a-plenty in this fine big industry for all of us.

To all of you we say,
A Merry Christmas
and a great New Year

Watch these pages in the January issue for an announcement of real importance to the trade



CARRYOLA COMPANY of AMERICA
647 Clinton Street Milwaukee, Wisconsin

*The Tie
that binds—*

The
**CARRYOLA
MASTER**



TAKE a good look at the Carryola Master, the tie that binds Carryola Dealers to Carryola Jobbers and Carryola Jobbers to us.

It's the most popular portable in the world.

It has made more money for those that sell it than any single portable ever manufactured.

You can't just throw a lot of parts together and get a Carryola Master.

Thousands of dealers today are selling Carryolas as they should be sold—and gaining the fine profits that are justly theirs.

The Carryola Master is accepted nationally as the standard of portable value. More people will buy it in 1927 than in 1926. *More dealers will profit through these sales!*

Our big national advertising campaign will be continued! Start thinking with us now about 1927.

No other portable offers so much to music dealers and to the public.

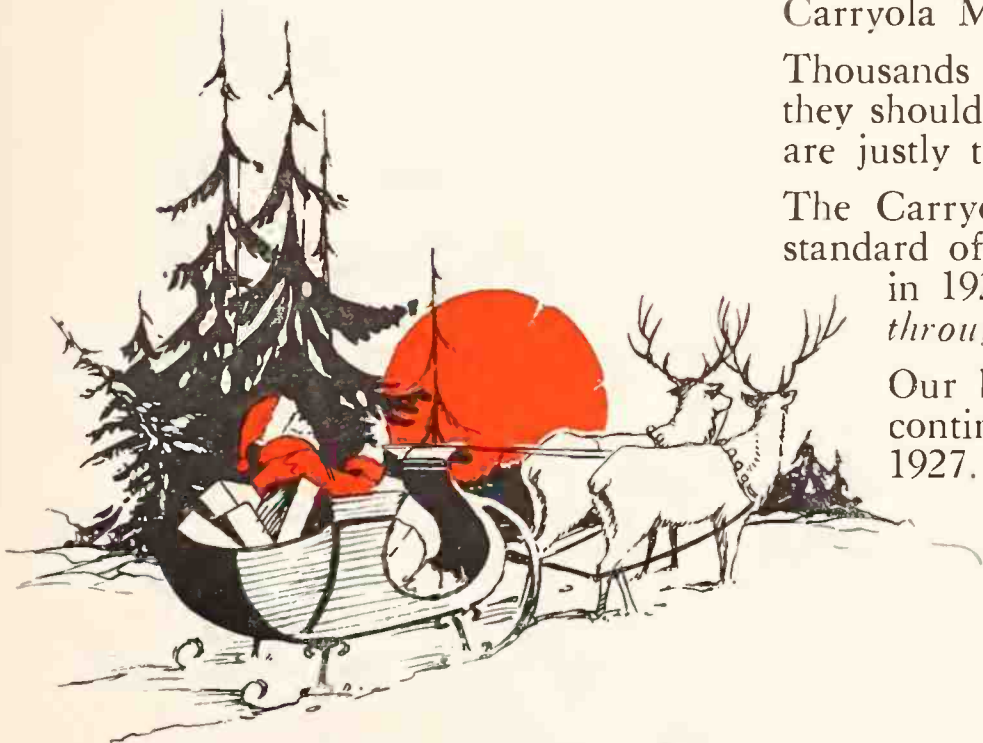

CARRYOLA COMPANY of AMERICA
647 Clinton Street
Milwaukee, Wisconsin

Interesting Events of the Trade in Pictures



Left: "Miss Seattle" looking over new Orthophonic Victor records at store of a live retailer in Seattle, Wash.

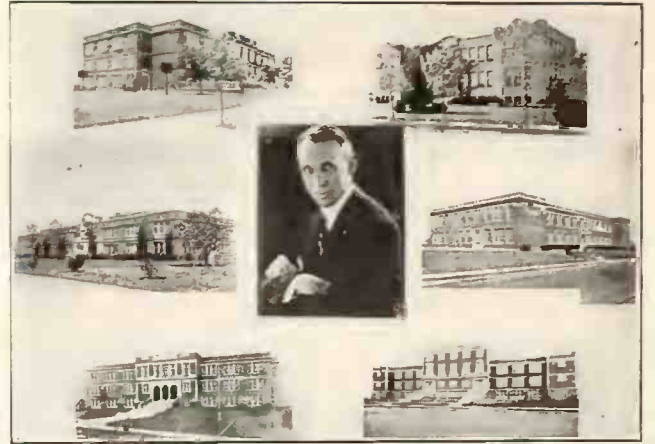

Above: Dallas schools equipped with Brunswicks by Will A. Watkin Co. Center: Robert Watkin

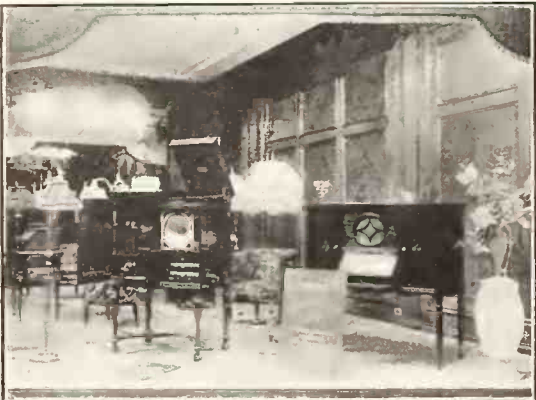

Above: Brunswick display at Consolidated Gas & Elec. Light & Power Co., Baltimore



Above: Tuning in on Stewart-Warner Model 355, equipped with wave length indicator



Above: Interior of new branch store of the Corley Co., Petersburg, Va.



Left: How Rowe Furniture Co., Billings, Mont., displays Stromberg-Carlson Radio

Left: Annual meeting and banquet of Radio Trades Association of Southern California



Above: Unusual window display of Radio-Phono Shop, Jacksonville, Fla.

New Fada Poster

The poster reproduced herewith is being sent to all franchised Fada dealers. It is three feet high and four feet wide, and is printed in color. L. C. Lincoln, advertising manager of F. A. D. Andrea, Inc., under whose direction the poster was prepared, states that this is the first time that the New York Philharmonic Orchestra has permitted its name and photograph to be used in connection with radio products. The display was reproduced from original paintings, to portray "Harmonated Reception" through a Fada receiver and Fada cone speaker. This is publicity of the kind that dealers will find worth using in windows and other places where the public can view it.

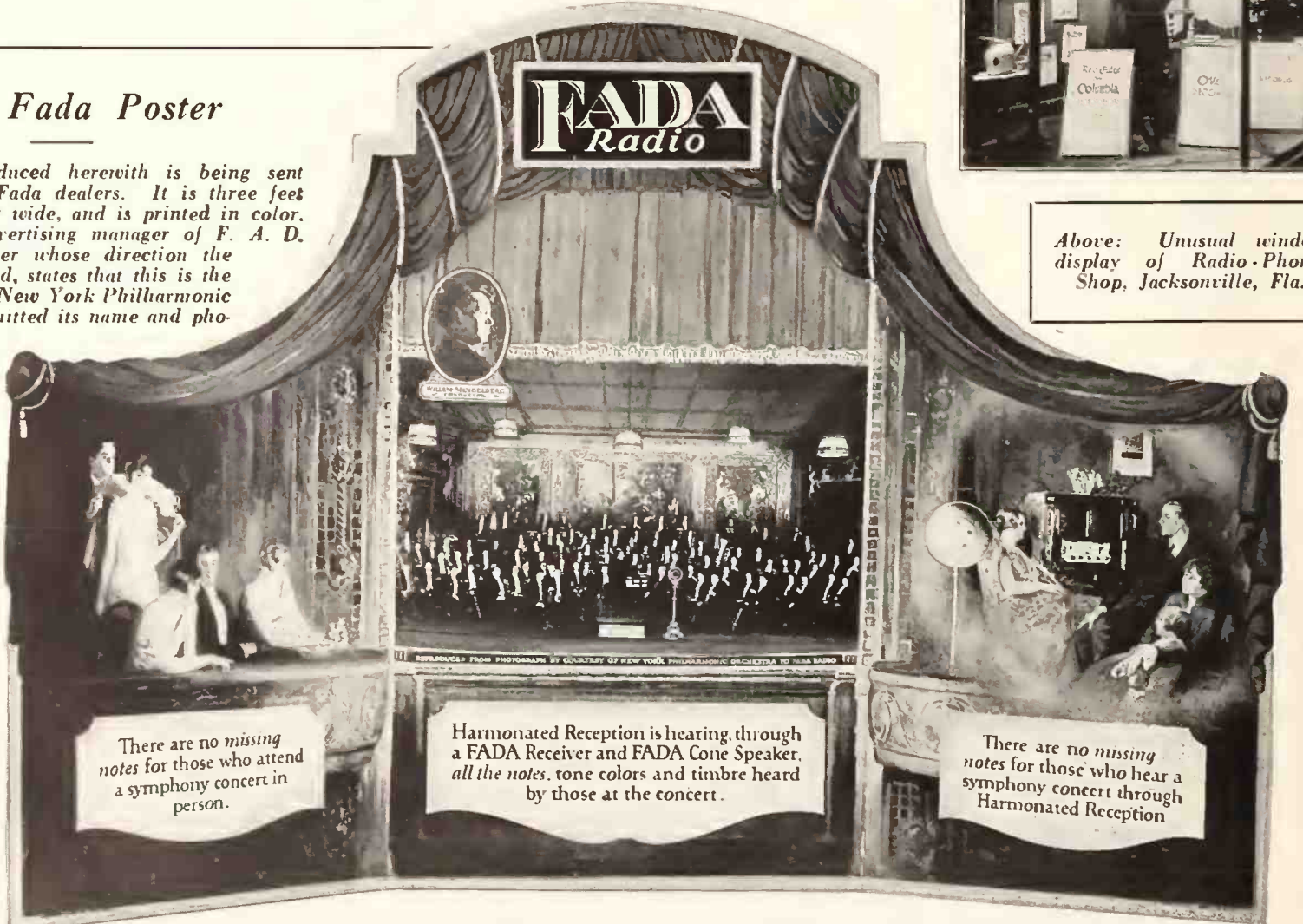

There are no missing notes for those who attend a symphony concert in person.

Harmonated Reception is hearing, through a FADA Receiver and FADA Cone Speaker, all the notes, tone colors and timbre heard by those at the concert.

There are no missing notes for those who hear a symphony concert through Harmonated Reception

VITA-PHONIC PRODUCTS

Tone Arms — Reproducers

J. E. RUDELL :: 83 Greene St., New York City

G. S. Bryan Writes Forceful Biography of Thos. A. Edison

"Edison: The Man and His Work," is the title of a very interesting biography of Thomas A. Edison, the great inventor, which has just been issued by the publishing house of Alfred A. Knopf. Inasmuch as the famous inventor is soon to celebrate his eightieth birthday this volume appears at an appropriate time, as it gives an opportunity to reflect on the important part played by Edison in the countless changes that have transformed so many of the accommodations of our daily life.

When we stop to estimate that some \$15,000,000,000 represents the present investment of this country in industries either based on the inventions of Edison, or stimulated by him, we have some idea of the importance of the man and his work. Geo. S. Bryan, the author, has handled the subject in a manner to make most interesting "copy." He is seldom over-technical, and therefore there is an appeal to the average mind that makes this new volume one of exceeding interest. The achievements of Edison in the field of invention, as well as practical accomplishments, are traced in detail, and this new biography of Mr. Edison, as an assiduous delver into the baffling secrets of electricity is well worth reading.

Radio Manufacturers Association Holds Interesting Meeting in New York City

Members of the Eastern Radio Trade Out in Force to Attend Meeting—Herbert H. Frost Presented Association's Plans for Radio Show in Chicago During Week of June 13, 1927

The R. M. A. (Radio Manufacturers Association) held a very interesting luncheon and meeting recently at the Hotel Commodore, New York, coincident with the visit to this city of B. W. Ruark, executive vice-president of the Association. The meeting was attended by approximately fifty members of the Eastern radio trade, who evinced keen interest in the various subjects discussed during the session.

S. B. Trainor, president and general manager of the Amplion Corp. of America, and a member of the R. M. A. Directorate, presided at the meeting and introduced several topics which were discussed by the members present. Herbert H. Frost, the first president of the R. M. A. and chairman of the Association show committee, presented full details as to the Association's plans for the trade show to be held at the Hotel Stevens in Chicago the week of June 13. This show promises to be one of the most important events in the history of the radio industry and will undoubtedly be a factor in stabilizing merchandising conditions during the coming year. The main ballroom of the Stevens Hotel, with

approximately 20,000 square feet of space, will be devoted to the trade show, every detail of which will be under the auspices of the R. M. A.

Advance reservations already received for space indicate that manufacturers will be obliged to accept a proportionate allotment of the space requested, for the space applications will apparently be far beyond the facilities of the ballroom. The exhibition rates are nominal and the show will be conducted in such a way that it will not interfere in the least with the proceedings of the R. M. A. convention to be held at the Hotel Stevens the same week as the show. At Mr. Trainor's suggestion everyone present was given an opportunity to discuss the various details regarding the show program and it was the unanimous opinion of those present that the show will be a tremendous success and of incalculable value to every factor of the trade. Other topics mentioned during the meeting were suggestions as to the elimination of confusion in broadcasting wave lengths, standardization of parts, trade and fan paper advertising and credits.

The line for Christmas selling is here....!

BEAUTY, unique design, satisfying performance, price range—what more can you ask of a line for brisk Holiday merchandising? Certainly turnover will be rapid and profit satisfying to all Velvet Dealers. If you are interested in the Velvet franchise, wire us quickly.

The Jewel Case No. 21

As an example, take the "Jewel Case". Certainly no other speaker ever had such rare beauty and charm of outward appearance! And the volume of rich, clear, delightful tone is just as surprising. The ideal Radio Christmas gift!

Sales Department
Jobbing Division
THE ZINKE CO.
1323 S. Michigan Ave.,
Chicago, Ill.

Manufactured by
The BORKMAN RADIO CORP.
Salt Lake City, Utah
Kalamazoo, Mich.

No. 12, \$16.00
12 1/2 in. Bell
No. 15, \$23.50
14 1/2 in. Bell

Borkman Velvet Speakers bring beauty of tone and surprising range to radio. There is a superiority that you'll admit instantly when you hear one.



No. 18, \$27.50
"The Chinese Cone-flex"
All the low tones of the cone with all the higher notes of the horn. Beauty and Symmetry too!

No. 9, \$12.50
"The Lantern"

Unique in conception—beautiful finish, pleasing harmonious lines. Real power and tonal beauty too



No. 21, \$45.00
"The Jewel Case"
The most extraordinary speaker ever marketed

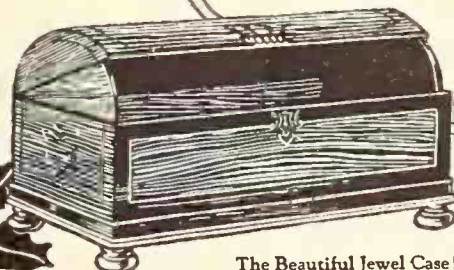

The Beautiful Jewel Case!

Why Is This Man Standing on a Kolster Chassis?

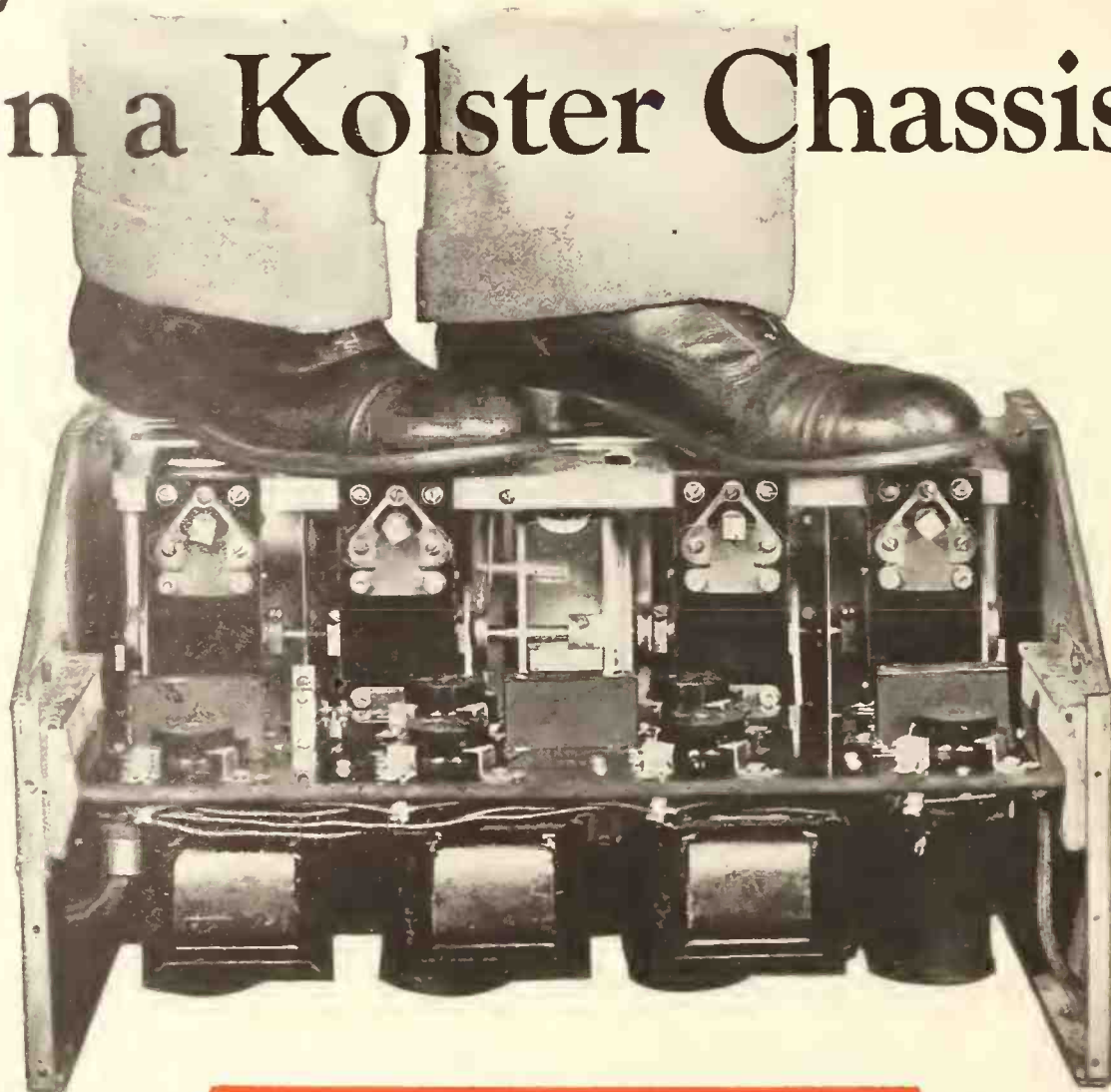

This sturdy chassis is housed in a metal box, keeping all dust and dirt away from the condensers.

This 203 pound man standing on the condenser chassis of a Kolster is pictured to emphasize the super-strength of Kolster construction.

Kolster Radio is built to stay in working order for years. Such design insures perfect alignment and permanent balance.

Every demonstration proves Kolster's superiority in performance. Every examination of its design and construction proves it will continue to give constant satisfaction to the customer.

In selling a Kolster, you're winning a friend—he'll recommend it to others.

Kolster Radio

“Triple Strength” Dr. Kolster Insisted

“Now that the set is electrically correct, make it triply strong,” said Dr. Kolster.

See the tuning condensers and cradle of a Kolster Set—how sturdy: Note how strongly the stator plates are fastened.

There’s a quarter inch die cast aluminum support between each condenser.

There is one of many examples of Kolster fine engineering. Examine the Set for yourself—note its rigidity and permanence.

Of course your customers want a convincing demonstration. Kolster gives it—in addition it insures constant satisfaction.

Send for complete technical description of the Kolster line.

Fill in the coupon below for a demonstration. It costs you nothing.

If you can balance a golf ball on the eraser of your pencil, you will have achieved the perfect balance found in a Kolster Set.

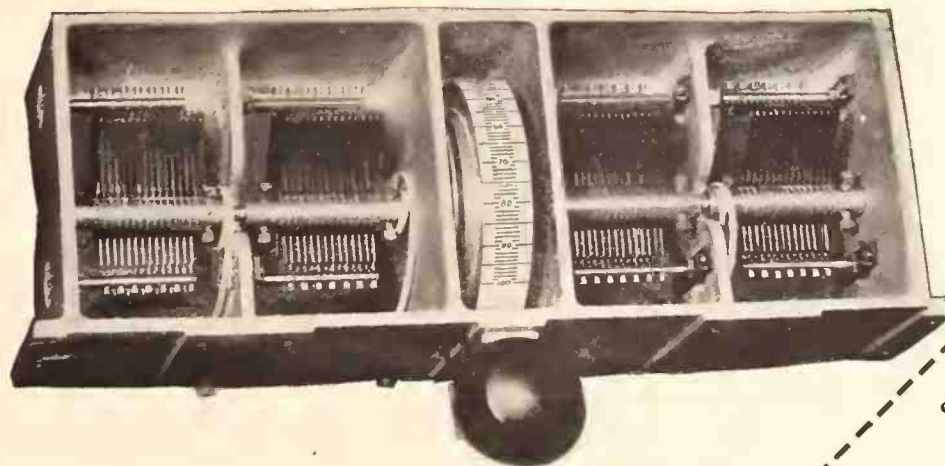

22

FEDERAL-BRANDES, INC.

Woolworth Bldg., New York, N. Y.

Please arrange a Kolster-Brandes demonstration. It is understood that this does not obligate me.

Name.....

Street.....

City..... State.....

Brandes Speakers

Radio Tie-Ups With Important Events Build Sales

How Dealers Are Deriving Added Profits From the Radio Department by Staging Tie-up With Events of Wide Public Interest

Radio lends itself peculiarly to effective tie-ups with local and national events of importance—tie-ups that can be turned to profit by progressive retailers. Special broadcasting programs

SHERMAN, CLAY & CO. FOR RADIO SETS AND SERVICE.

Football is here!

Follow the games on your Radio!

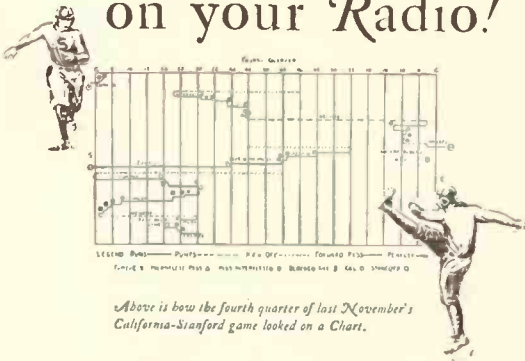

Above is how the fourth quarter of last November's California-Stanford game looked on a Chart.

We have prepared a blank form Radio Football Chart, containing schedules and all directions, for stay-at-home football fans. Come in and get your set of charts with our compliments!

Surely you have a good, suitable Radio set with which to follow the games. No? Then be sure to ask for a demonstration of the great Gilfillan shielded neodynes. These are priced at \$90, \$175 and \$350 without accessories. You can get your set at Sherman, Clay & Co. on very convenient terms.

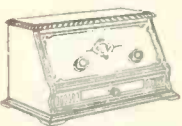

This is Gilfillan X—\$90 ten accessories

Sherman, Clay & Co.

Kearny and Sutter Sts., 3-5
Market Street, near Twenty-first
Fourth and Clay, Oakland
Telegraph and Chicago, Berkeley

Sherman-Clay Radio Football Tie-up can be made to build retail sales. This was exemplified during the recent World Series baseball games. Intense interest in the outcome of the Series was manifested throughout the country by millions of people. The details of every play during the Series were broadcast and the interest of the public was strong enough so that many who did not own radio sets purchased

them in time to get the baseball results. The same with prize-fights that have been held recently. One dealer reported that during the two weeks preceding a widely heralded fight his radio sales increased 30 per cent. Other dealers reported similar results. Many of these merchants featured the desirability of owning a radio set to get the fight returns in their advertising.

The illustration herewith is that of an ad placed in the newspapers by Sherman, Clay & Co. It illustrates in a concrete manner the point brought out above. This football radio advertisement was prepared by Neill C. Wilson, advertising manager of the store. Mr. Wilson realized that thousands of people would be unable to secure tickets at any price for the big games of the year between leading universities. A set of charts also was prepared by Sherman, Clay & Co., so that owners of radio sets could follow the progress of football games more intelligently.

St. Louis Jobber Forms the Red M Organization

Mayer & Co. Plan to Make Their Dealer Clients Distinctive in the Retail Radio Field—Unique Plan of Merchandising Announced

Mayer & Co., Inc., radio wholesalers, of St. Louis, Mo., have evolved an unusual plan to aid their dealers in merchandising radio. The dealers who do business with the concern will be known as the Red M Dealer Organization, founded, according to Mayer & Co., to group together the best and most progressive radio dealers to serve the undecided and perplexed buyer by handling radio of the highest grade and upon whom the public can rely to receive dependable apparatus and service.

Mayer & Co. propose to advertise the Red "M" organization so that it will become foremost in the minds of prospective radio buyers. All are designated by the Red "M" decalcomania or sticker—"the mark of quality."

Every Red "M" dealer is regularly posted with news items which are of interest to him—mainly change in prices, service, laboratory tests on equipment and installation work. Dealers also will receive the Red "M" Radiocaster service, to keep them abreast of the progress of the radio industry. This is a bulletin issued by Mayer & Co., which plans to co-operate with

MICA DIAPHRAGMS

Immediate delivery—all sizes
Send for free samples and prices
All Mica Products

INTERNATIONAL MICA CO.

Phone Barling 835 PHILADELPHIA, PA. Cable Filasaw, Phila.

the radio manufacturers and will be interested in receiving their bulletins.

The first issue of the Red "M" Radiocaster is being distributed to the trade. It announces the policy of Mayer & Co. and states that one dealer will be appointed in each locality.

New Zenith "B" Battery Eliminator Introduced

Zenith Radio Corp.'s New Product Said to Be Noiseless and Humless

A "B" battery eliminator, which is said to be noiseless and humless, designed for use on all makes of sensitive receiving sets, is one of the latest products of the Zenith Radio Corp., Chi-



Zenith "B" Battery Eliminator

cago. The Zenith "B" delivers 60 milliamperes, this high capacity having been especially provided to meet the requirements of Zenith receivers. It is said by the manufacturer to be one of the few eliminators which will carry the load of the ten-tube Zenith DeLuxe receiver and the manufacturer states that it will operate without objectionable hum on sets that have three or more stages of audio amplification. The eliminator is equipped with taps, making possible a range of 12 voltages, and it fits into the end compartment of the Super Zenith cabinet. It operates on 110 volts alternating current of 60 cycles only and retails for \$60.

Graham Amplion, Ltd., Makes Amplion Radio

In order to give adequate attention to the tremendous growth of all factors of business, Alfred E. Graham & Co., London, England, manufacturers of Amplion products, announced recently the complete separation of the two divisions of their business, the manufacturing of telephone products and the manufacturing of wireless products. By the terms of these arrangements, the Amplion telephone products will be manufactured and sold by a division of the company which will be known as Alfred Graham & Co., Ltd., while the company's wireless or radio products will be made and marketed by Graham Amplion, Ltd. This separation of the Amplion divisions will enable the Graham organization to devote adequate time and attention to the various branches of its activities, which during the past few years have increased tremendously throughout the world.

8point CONTACT

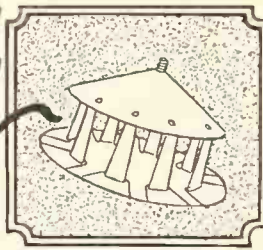

Unique Tower feature

In the Tower Speaker, there are eight contact points between unit and cone. This design, exclusive with Tower, gives a range and quality of tone unexcelled in speakers selling for twice the price. It is but one of many other exclusive Tower features.

Write us for your Distributor's Name
TOWER MFG. CORP. Boston, Mass.



\$15.00

Tower
Meistersinger
cone



Type GSX-171
High power tubes for use in last stage of audio amplification give increased volume
Price \$4.50
Look for the red box

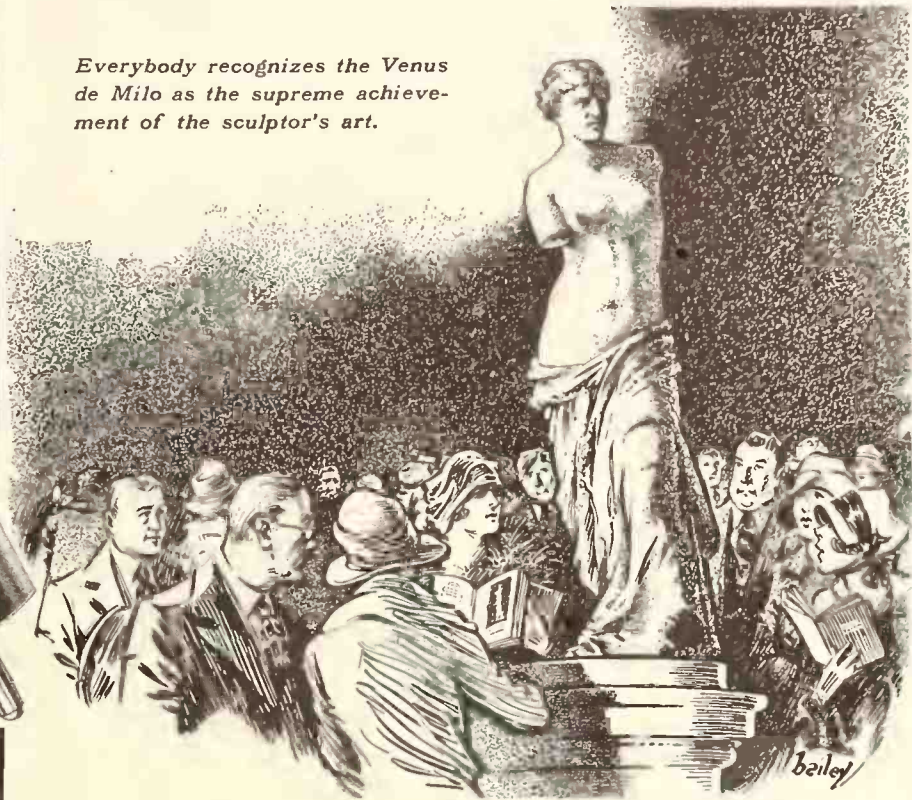

Everybody recognizes the Venus de Milo as the supreme achievement of the sculptor's art.

Profits Follow the Crowd

People soon recognize superiority, whether in radio tubes or any other combination of art and skill.

Gold Seal Tubes have won public favor—sales increasing by leaps and bounds. Are you riding on this profit-wave of popularity?

Made right, sold right, and *guaranteed* right — by a company whose record is your best assurance of permanence and a square deal to both jobber and dealer.

Yes, quality counts. It is making money for hundreds of Gold Seal dealers right now. You should be sharing in this success.

Insist on genuine GOLD SEAL Radio Tubes—

All Standard Types

Type GSX201A \$2.00	Type GSX120 . \$2.50	Type GSX216B . . \$7.50
" GSX199 . 2.25	" GSX200A 4.00	" GSX112 4.50
" GS199 . . 2.25	" GSX171 . 4.50	" GSX20-Hy-Mu 4.00

If not obtainable from your jobber, write us for particulars of our attractive dealer proposition.

Have you seen the new Gold Seal window and counter displays? Ask your jobber or write us today.

Gold Seal Radio Tubes

**Jobbers! Some desirable territories still open.
Full Protection. Write for particulars.**

**GOLD SEAL ELECTRICAL CO.
INCORPORATED**

250 PARK AVE., NEW YORK



Type GSX 216B
For use in battery eliminators to rectify alternating current—advantageous in supplying the higher current required by power tube equipped sets.

List price \$7.50



Type GSX-112
High power tubes for use in last stage of audio amplification give increased volume.

List price \$4.50



Type GXS-200A
For use as detector only, giving superior strength on weak signals—especially desirable for distance.

List price \$4.00



Type GSX-20Hy-Mu
For use only in the popular resistance coupled amplification, highly efficient in this system.

List price \$4.00

All Standard Types

ATWATER KENT RADIO

To Atwater Kent Dealers

Read Mr. Kent's remarks about tone in the advertisement on the opposite page, reproduced from the Saturday Evening Post.

Familiarize yourself with the *reasons* for the superior quality of *tone* which you recognize whenever you hear an Atwater Kent Radio Speaker.

Note that *every* type of speaker has been tested in our laboratories and that we make the Atwater Kent type "because to-day no other design gives such a faithful, satisfying *tone*."

In selling Radio Speakers to your customers, tell them about Atwater Kent *tone*—and tell them the "reason why."

ATWATER KENT MANUFACTURING COMPANY
4725 WISSAHICKON AVENUE A. Atwater Kent, President PHILADELPHIA, PA.

THE SATURDAY EVENING POST

ATWATER KENT RADIO

Why your speaker is vital to your enjoyment of radio

BY

A. Atwater Kent

TODAY, when you ask people what they want in a radio set, most of them answer: "Tone." They may call it "clear reception" or "a natural quality," but however they describe what they want it always means *tone*.

They realize, as we do, that the purpose of a radio receiving set and its companion, the radio speaker, is to connect your home clearly with all the broadcasting stations within range.

Therefore, the set and speaker

which do their work clearly and naturally with the truest tone are most desirable.

But many a good receiving set has been blamed when the fault was in the speaker, for a radio speaker is the instrument that gives voice to the receiving set. It can make or mar a good radio program—for it can make or mar the tone that you hear.

All Atwater Kent Radio Speakers are the horn type, because we believe that this type gives

a quality of tone superior to any other.

To assure natural tone, a speaker must have size and weight. It must have enough room to translate a great many minute vibrations into music or a true reproduction of the human speaking voice. It must produce true and clear tones without hollow, drumming sounds. And it must be so constructed that the tone will not deteriorate as time goes on.

In our laboratories we have fully tested every type of speaker. Today no other design gives such a faithful, satisfying tone as the one which we recommend. When we find that any other type of speaker will produce better results, we will make it.

EVERY SUNDAY EVENING.—The Atwater Kent Radio Hour brings you the stars of opera and concert, in Radio's finest program. Hear it at 9:15 Eastern Time, 8:15 Central Time, through:

- | | |
|---------------------------------|------------------------|
| WEAF . . . New York | WGN . . . Chicago |
| WJAR . . . Providence | WFI . . . Philadelphia |
| WEEL . . . Boston | WCAE . . . Pittsburgh |
| WRC . . . Washington | WGR . . . Buffalo |
| WSAI . . . Cincinnati | WOC . . . Davenport |
| WTAG . . . Worcester | KSD . . . St. Louis |
| WTAM . . . Cleveland | WWJ . . . Detroit |
| WCCO . . . Minneapolis-St. Paul | |

Prices slightly higher west of the Rockies and in Canada. Write for illustrated booklet of Atwater Kent Radio.

ATWATER KENT MANUFACTURING COMPANY
A. Atwater Kent, President
1703 WISSAHICKON AVENUE, PHILADELPHIA, PA.

Of course you'll want a speaker as good as your set. With an Atwater Kent Radio Speaker you are sure of natural tone and all the volume you wish. Model L shown at right; finished in dark brown crystalline, \$116.00.



A good set deserves a good speaker—that means nothing less than an Atwater Kent Radio Speaker. It is the standard of good tone reproduction everywhere. Model II shown at left; finished in dark brown crystalline, \$91.00. Model G, same design in amber buff and sage green, \$23.00.



Model 32, the extra powerful seven-tube One Dial receiver, less tubes and batteries, but with battery cable attached, \$140.00.

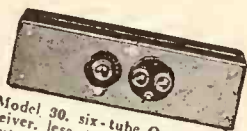

Model 30, six-tube One Dial receiver, less tubes and batteries, but with battery cable attached, \$95.00.



Model 33, six-tube One Dial receiver, shielded cabinet, less tubes and batteries, but with battery cable attached, \$70.00.



Model 20 Compact, five-tube Three Dial receiver, less tubes and batteries, but with battery cable attached, \$60.00.

New Long-Playing Edison Records Have Been Received in St. Louis Territory

Mark Silverstone, Edison Distributor, Declares Public Is Keenly Interested in the New Product and Large Sales Are Anticipated—Trade Activities of Month

St. Louis, Mo., December 7.—“The new long-playing Edison records have arrived and the demand for them is even larger than our expectations,” states Mark Silverstone, Edison distributor, who further reports that the public is showing itself to be keenly interested in this Edison product. He continued, “The demand for radio equipment is also on the upgrade, following a short period of slackness, and the outlook is satisfactory.”

Jobbers of phonographs report good business throughout their territory for November.

“The holiday trade is picking up,” was the report from the Brunswick Co., while the Artophone Corp., a St. Louis concern, reports that wholesale trade is good and new machines are going in a lively manner. The 200-page catalog

of this concern is just out and is being distributed to the trade.

The Conroy Piano Co. has put in the line of radios made by the Kellogg Switchboard & Supply Co., of Chicago. These are six-tube sets and come in three models. The Conroy Co. has an attractive window display of these popular radio receivers.

The Kieselhorst Piano Co. is featuring the Freed-Eisemann and King radios.

The Thiebes Music Co. has an attractive window display of the one-dial six-tube Atwater Kent radio—the small size that conveniently goes in a desk.

Radio station WSBF, owned by the Stix, Baer & Fuller Dry Goods Co., is broadcasting the concerts given every Sunday afternoon by

an orchestra of sixty-five at Loew's State Theatre in this city.

R. W. Bowen is a new representative of the Artophone Corp. in North Carolina, South Carolina and Virginia. R. C. Mayer, vice-president of that company, has been on a trip to the trade through Alabama and Georgia.

The Brunswick branch reports that it could not get machines fast enough to supply the Southwest demand.

Studner Cummings & Co., Inc., Are Host to Dealers

New Eckharmonic Radio and Eckophonic Resonator Presented to Trade

Studner Cummings & Co., Inc., manufacturer's agent, New York City, was host to its dealers at a banquet held at the Hotel Astor on November 10. The occasion was the presentation of the new Eckharmonic radio with Eckophonic resonator, made by the Eckhardt Corp. of Philadelphia. Studner Cummings & Co., Inc., has been appointed manufacturer's agent for this line in the metropolitan territory.

Walter L. Eckhardt, president of the Eckhardt Corp, outlined the history of the new product and told of the future plans now being worked out. George J. Chase, of the Aitkin-Kynett Co., Philadelphia, Pa., advertising agents for the Eckhardt Corp., told of the advertising plans of the company.

Dealers Successful in Tie-ups With A. K. Hour

The Atwater Kent radio hours, which are broadcast Sunday evenings from station WEAJ and associated stations, continue to present some of the world's best-known musical artists, and increasing numbers of Atwater Kent dealers are proving to their own satisfaction the value of tying up with the programs offered. Since the last issue of The Talking Machine World the following prominent artists have appeared before the microphone. On Sunday, November 21, Reinald Werrenrath, baritone; November 28, Lucrezia Bori; December 5, a joint concert by Mabel Garrison, soprano, and Ernst Von Dohnanyi, pianist, and on December 12 Mme. Frances Alda, soprano.

Demonstrate Victor Model

JACKSONVILLE, FLA., December 6.—For a week, starting November 23, the Victor Talking Machine Co., working in conjunction with the French Nestor Co., Victor distributor, demonstrated the Victor Auditorium model Orthophonic to many thousands of residents of the city and visitors. Victor dealers throughout the State took advantage of the publicity secured through the demonstrations.

Valley Forge Spring Chart

A new Valley Forge main spring chart has been sent to the trade by the J. A. Fischer Co., Philadelphia, maker of Valley Forge main springs and talking machine repair material. It follows the concise form of previous issues. The new chart contains sixteen new spring sizes, bringing the list to eighty numbers. It is said to be one of the largest spring charts in existence and includes sizes for practically every make of the new type of talking machine.

Featuring Edison Line

The Utica Phonograph & Supply Co., Inc., has been featuring the new models of Edison phonographs and records with great success at its headquarters, 36 Blandina street, Utica, N. Y. This concern also handles the Sonora radio, which has won a large measure of popularity in the central section of the State.

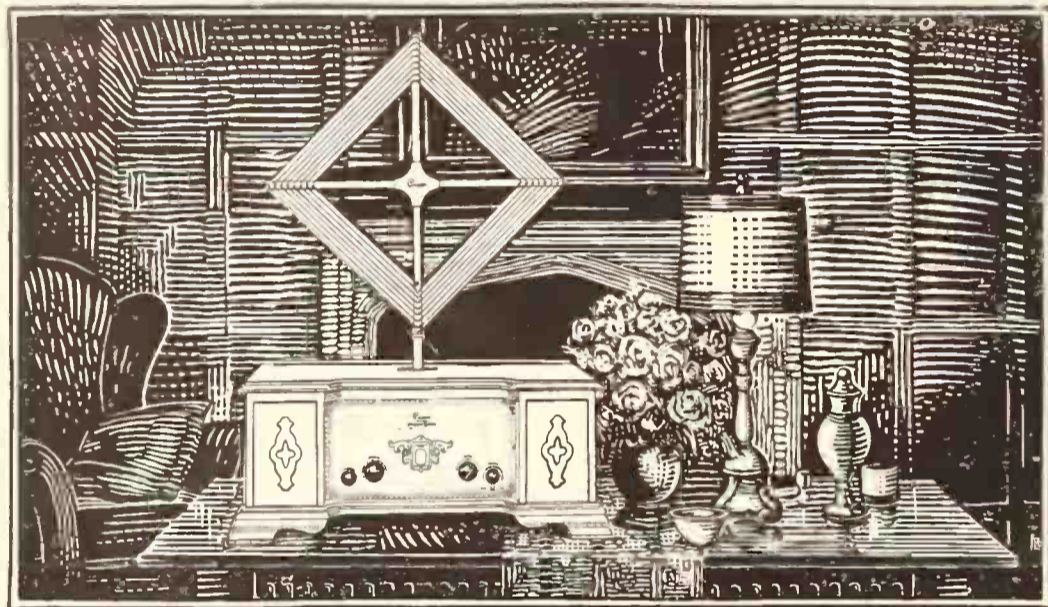

PRIESS STRAIGHT NINE
List Price without accessories \$335.00

Write for name of our distributor in your territory

[We have a most unusual opportunity for the right man]

SOME very desirable territory is still open. We give exclusive representation and a dealer franchise.

Our line includes a sufficiently wide price range to meet all requirements of a high-class dealer.

Priess Straight Nine, giving great sensitivity and distance on loop alone. List Price, in handsome figure mahogany cabinet, without accessories \$335

Priess Straight Eight, especially adapted for rural localities (the sensation of last season) will continue to be made to comply with dealer demand. List Price, with accessories \$175

Priess
TRADE MARK
STRAIGHT **9** NINE

Priess Radios are nationally advertised.
Full information on request.

PRIESS RADIO CORPORATION
693 BROADWAY NEW YORK

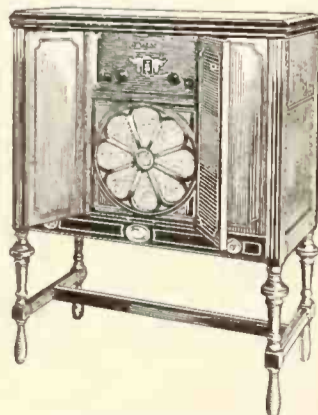

Console Model, \$335

The TRUTH



January 1st.

RIGHT NOW your business is good—so good that it's hard to think of a time when sales will *come hard*. But just a few strokes ahead of you is that old sales drop that has dented the bottom of many a good ship.

You know what happens to the radio and music business after the first of the year. As the mercury goes up, *your sales go down*. That's the truth—proven by all the years you have been in business.

The Bell & Howell line of Motion Picture Cameras, Projectors and accessories is being added NOW by hundreds of music dealers who want sales to *stay up* through the spring and summer months. Lyon & Healy and J. L. Hudson Co., two of the largest, were among the first to sign our protective dealer franchise.

Dealers who stock now will benefit 30 to 60 days ahead of the dealer who waits till music sales go dead. It takes that much longer to gather momentum from a standing start. *Right now* is the time to inquire into the possibilities of this new line.

Turn to the next page
for evidence upon which
to base your decision



BELL & HOWELL COMPANY

1810 Larchmont Ave., Chicago, Illinois

New York, Hollywood, London

ESTABLISHED 1907

This Explains the 4-color page to your right

— a tremendous sales force seeking out customers
in every highway and by-way in the Nation and
sending their business to YOU.

ON the preceding page you were asked to consider Bell & Howell Motion Picture Cameras and Equipment as a logical line to add to your regular music and radio lines. Reason No. 1 is that you *need* such a line to bolster sales as weather grows warmer. Here's reason No. 2:

Note how the beautiful 4-color illustration on the opposite page is tugging for attention even as you read this. The whole page is the December Bell & Howell advertisement exactly as it appeared in the Saturday Evening Post of December 11th.

Note how the copy refers the reader to *a good dealer in his locality*. The coupons we receive are also referred to the dealer so that he can follow through, close the sale, and make a profit.

This is but one of a series of 13 full page, four-color Bell & Howell advertisements appearing in the Saturday Evening Post, in addition to full pages in other publications.

Dealers in very few lines are given such advertising support. And seldom does an advertising campaign meet with such terrific consumer response as has been accorded this one.

In handling Bell & Howell equipment you will be given a protective franchise. You will be furnished adequate display and mailing material. And you will have a line of merchandise so superior that competition cannot touch it. It's worth a stamp and a moment's time to find out more about it NOW.

MAIL THIS FOR DEALER PROPOSITION

BELL & HOWELL CO.

1810 Larchmont Ave., Chicago, Ill.

Please send me complete details of your motion picture camera and equipment Dealers Sales Proposition.

Name _____

Address _____

Do yourself a
timely favor by
**MAILING
THIS COUPON**



What a gift!

YOUR OWN MOVIES — THIS CAMERA gives them real photoplay beauty and clearness

THIS is a gift for someone of whom you are very fond. It truly opens a new door of delight . . . home entertainment of a new kind, the year around!

Real movies of the people and places and events that are dear to memory! Stop and think for just a moment of the thousand and one things you'd like, recorded in pictures that move and live for a lifetime.

The camera you see reproduced here brings this new delight to its highest perfection. It is the Bell & Howell Automatic FILMO—4½ pounds of amazingly simple, movie-taking ability.

Some important facts

You recognize of course the differences there must be between the regular, still-picture photography—and motion photography.

Well, FILMO is the product of 19 years' experience in making practically all the movie cameras and equipment used by leading motion picture producers of the world. Hence it possesses movie-taking ability matched only by the famous Bell & Howell professional cameras which cost up to \$5,000 each.

Yet FILMO costs no more than a reasonably good radio set.

It is fully automatic. You can hold and operate it with one hand, if necessary. Every feature

necessary for taking perfect movies is provided—yet nothing complicates operation.

A child, actually, can operate FILMO. And get pictures as clear and sparkling as your favorite photoplays! The features that make this possible are listed below. They are not found on any other personal-movie camera.

Your films are developed free—ready to show in your own home.

What coupon brings:

If you'll send the coupon below, we'll provide you with name and address of a good dealer in your locality who will be glad to demonstrate and tell you all about FILMO. And we'll also send a new book on the subject of taking your own movies.

Christmas isn't far off. Better clip your coupon right now.

THESE FILMO FEATURES give you "feature film" pictures

If you want movies of your own that really compare with feature films seen at your favorite theatre, you must have these features in your camera. They were perfected by the world's largest makers of motion picture cameras. They simplify, and really insure, the taking of perfect motion pictures. Only FILMO has them!

- (1) Spy-glass view-finder
- (2) Adjustable, accurate speed-control—for different objects and lights

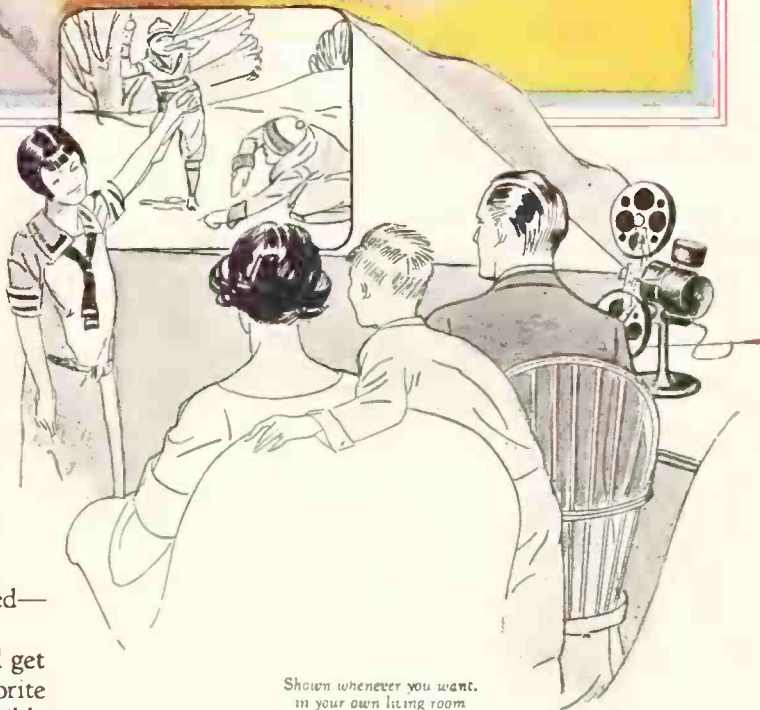

Shown whenever you want. in your own living room

- (3) Special mechanism for s-l-o-w motion pictures, in same design of camera
- (4) Highest-quality, imported anastigmat, 25 m/m F3.5 aperture lens
- (5) Simplest to operate of all movie cameras
- (6) 12 lenses interchangeable for special work
- (7) Beautifully finished, compact, efficient
- (8) Lifetime service; no depreciation

FILMO AUTOMATIC PROJECTOR

—for showing these movies in your own home—offers same superiority as FILMO. Simply press a button and get pictures as brilliant and flickerless as you see at best theatres. Runs forward, backward, or stops for single picture. Shows pictures from postcard size up to 7 x 9 feet.

THE BELL & HOWELL Automatic



Hundreds of Thousands \$\$ ~ of Dollars ~ \$\$ at stake in one colossal movie production!

Cecil B. De Mille using a Bell & Howell Eyemo Camera in filming some of the "shots" in "The King of Kings."



Ernest Torrence, as "Peter the Beloved" in Cecil B. De Mille's "The King of Kings."

~ and BELL & HOWELL Cameras are chosen to make certain of good pictures

YOU will appreciate that the greatest film-productions are first staged and acted for the camera alone. And unless the camera faithfully records all that is enacted before it, all the hundreds of thousands of dollars invested in settings, transportation and fabulous salaries will have been thrown away.

From this you will understand the care with which the movie cameras must be chosen for photographing the stupendous spectacles you see on the screen.

And when you are informed that BELL & HOWELL Cameras have been chosen for these feature productions, almost without exception, for the past twenty years, you appreciate the world-wide esteem in which these Cameras are held.

In the above illustration you see the famous producer, Cecil B. De Mille, directing the giant release, "The King

of Kings." In his right hand he is holding a Bell & Howell Eyemo Camera. This is a small, automatic professional camera used for special effects, stunt shots, locations and wherever mobility and speed are required.

The Bell & Howell FILMO Camera, which is selling like wild-fire for taking amateur "personal" motion pictures, is a smaller edition of the EYEMO. It uses film only about half as wide, though taking 2½ times as many pictures to the foot. It is just as exact, in every detail, as the larger professional camera. Yet its cost is within reach of the modest income. And it is even easier to use than the ordinary "snap-shot" camera.

When you handle Bell & Howell Cameras you handle the finest, most salable line of camera merchandise in the world. Doesn't the foregoing information prove it? Write at once for dealer proposition.

As a Bell & Howell Dealer You represent World-Wide Prestige

Turn back a page—and mail the big COUPON for Dealer Proposition



Trade Mark Registered

Three Thousand People Visit Radio Show Staged by a Live Dealer in Twin Cities

Howard Farwell & Co. Attract Wide Attention to the Lines They Handle by Arranging Exhibit—Trade Expects Holiday Business to Wind Up Year With a Rush—Month's News

ST. PAUL AND MINNEAPOLIS, December 7.—The Christmas seasonal rush has not yet started in this territory, but business is fair and most of the merchants are looking for excellent sales volume. With the highly successful Northwest radio show only a month past, plans for the one in 1927 are already under way. H. H. Cory, executive secretary of the Northwest Radio Trade Association, has reserved the dates, September 26 to October 1.

Howard Farwell & Co., of St. Paul, have just concluded a most profitable radio show at their store. E. O. Borglin put it over and he is receiving congratulations on its success. The firm members hoped for a thousand visitors and three thousand attended. The sales force was increased from five to fourteen and the profits were sufficient to pay for four more such shows. This company carries Radiola, Day-Fan, Atwater Kent and Victor Radiola combination sets.

The monthly review of the Northwest Radio Trade Association offers this helpful summary of conditions for the past four weeks: Helped Radio Business—the St. Paul dealers' show; the wonderful broadcasting programs for the month; opening of three or four branch jobbing houses in the territory; large schedules of advertising in the press, and, fifth, the opening of Foster & Waldo's big exclusive radio store. Hurt Radio Business—publishing of stories in papers about sun spots causing bad reception; jumping of wave lengths by a large number of small stations; poor deliveries from manufacturers discouraging to dealers.

According to J. E. Date, phonograph and radio manager for Doerr, Andrews & Doerr, the new Sonora "Shielded Six" is causing quite a sensation among the dealers. This set, as well as the Magnavox line, will be featured by Foster & Waldo in their new store.

The six Minneapolis dealers who carry Sonora and Magnavox goods report a very busy month and look for an increase over the previous month.

Mrs. Helen D. Beggs, manager of the Columbia branch, is greatly pleased with the reception given the new Pacific Coast recordings, of which the first list has recently been received. Mrs. Beggs expects a big holiday business in Viva-tonals.

A. J. Heath was a visitor the middle of the month and W. L. Sprague is at present at Columbia headquarters.

Again the Panatrope was featured with the Minneapolis Symphony Orchestra on November 29 as the nightingale in "The Pines of Rome."

The Bach Music Co., of Rochester, Minn., has sold the Brunswick Model P11 to the celebrated heads of the Rochester clinic, Doctors Charles and William Mayo. There is an extraordinary demand for the large type Panatrope and Panatrope Radiolas. Foster & Waldo are featuring these instruments in full-page advertisements and their slogans: "Music is essential" and "The Panatrope People" appear often in the page.

Mario Chamlee, Brunswick artist, appeared in St. Paul on December 2, following an engagement in Fargo, N. D., and dealers tied up extensively and cashed in on record sales.

Charles Hicks, manager of George C. Beckwith Co., Victor distributor, finds the rural trade outstripping the city business. Instrument sales are over three times last year's and the total volume, including radio, is more than double. Record sales are 50 per cent higher. November was the biggest month in the history of the company. Country dealers are clamoring for merchandise and it is impossible, at present, to open any new accounts. January

orders are already in and are larger than for the holiday month. February orders also are coming in.

Trade visitors to the George C. Beckwith Co. include Ivar Siedal, of Fergus Falls; Harry Chesterman, Crookston, Minn., and Art Hanson, Milltown.

Announces Engagement

Announcement of the engagement of Archie Altman, manager of the buying department of Davega, Inc., to Miss Mollie Wein, was made recently. Mr. Altman has been connected with the Davega organization for many years.

Foster & Waldo Open Radio Section in Separate Store

MINNEAPOLIS, MINN., December 4.—Foster & Waldo, one of the largest retail music houses in the Northwest, entered the radio field last month with the opening of a separate store featuring ten of the leading lines of radio receivers and a complete line of well-known accessories. The lines carried by the Foster & Waldo establishment are the Radio Corp. of America, Atwater Kent, Kellogg, Sonora, Magnavox, Sparton, Crosley, Fada and the Brunswick and Victrola-Radiola combinations. The opening of the radio department was announced in several full-page newspaper advertisements.

Vincent Lopez and His Casa Lopez Orchestra, Brunswick recording artists, presented recently at the Strand Theatre, New York, the first "musical cartoon" in history—a panorama of modern New York life.

It's Yours

Points about Spring-fitting

Twenty-eight pages of valuable information for the gramophone dealer, which deals with all the worries attendant upon Spring-fitting. You cannot afford to be without a copy.

This is yours for the asking, send a postcard now to:—

J. STEAD & CO., LTD.
Manor Works, Sheffield, England

Distributors of Sonora

THE INSTRUMENT OF QUALITY
CLEAR AS A BELL



New Reproducing Sonora
Phonographs . . . Model C
Radio Receiving Set . . .
Highboys . . . and Speakers

The Artophone Corporation,
1622 Pine Street,
St. Louis, Mo.

Baltimore Phono. Dist. Co.,
422 N. Howard Street,
Baltimore, Md.

Barker Wholesale Company,
Barker Building,
Los Angeles, Calif.

J. H. Burke Company,
221 Columbus Avenue,
Boston, Mass.

Doerr, Andrews & Doerr,
Minneapolis, Minn.

Gibson-Snow Co., Inc.,
Syracuse, N. Y.

Greater City Phono. Co., Inc.,
76 Fifth Avenue,
New York, N. Y.

Hassler Texas Co.,
2216 Commerce Street,
Dallas, Texas.

Kohler Distributing Co.,
63 Minna Street,
San Francisco, Cal.

McPhibben-Keator, Inc.,
68 Thirty-fourth Street,
Brooklyn, N. Y.

Moore-Bird & Company,
1720 Wazee Street,
Denver, Colo.

Pennsylvania Phono. Dist. Co.,
1015 Chestnut Street,
Philadelphia, Pa.
917 Wabash Building,
Pittsburgh, Pa.
1747 Chester Avenue,
Cleveland, Ohio.

James K. Polk, Inc.,
181 Whitehall Street,
Atlanta, Ga.
811 W. Broad Street,
Richmond, Va.

Rellance Battery Products Co.,
2211 So. Eighth Street,
Council Bluffs, Iowa.

C. A. Richards, Inc.,
100 E. 45th Street, New York, N. Y.
Canadian & Export Distributors.

C. D. Smith Drug Co.,
St. Joseph, Mo.

Sterling Roll and Record Co.,
137 W. Fourth Street, Cincinnati, O.

Strevell-Paterson Hardware Co.,
Salt Lake City, Utah.

The Tay Sales Company,
231 N. Wells Street,
Chicago, Ill.

Yahr-Lange, Inc.,
Milwaukee, Wis.
442 E. Lafayette Avenue,
Detroit, Mich.

Holiday Buying Keeps Cincinnati Trade Busy

Dealers Unanimous in Statements That Trade Is Getting Its Share of the Money Spent for Gifts—Shortage in Some Models

CINCINNATI, O., December 8.—Holiday buying is well under way, and dealers in talking machines and records state that the demand is better now than it has been for a long while, with sales almost reaching the volume of post-war "boom" times. Heads of leading concerns report that there is a tendency on the part of buyers to select the more expensive types of instruments and combinations. Portables are in brisk demand.

At the Chubb-Steinberg Music Shop it was reported by Howard L. Chubb that the holiday demand is fully up to expectations and talking machines and records are moving well.

At the Brunswick Shop, of which Louis H. Ahaus is proprietor, it was stated that phonographs of the more expensive type are in fine demand and that there is a brisk demand for records.

At the store of the Otto Grau Piano Co. it was reported by E. W. Young, manager of the talking machine and record department, that there is now a splendid demand, most of it being for the high-priced instruments and combinations. There is a shortage of some models, he declared.

"We are simply rushed to death with business," said Morris Fantle, head of the M. A. Fantle Co. "I have just telegraphed for more stock, and hope to get enough talking machines to carry us through the holiday season."

According to G. E. Hunt, of the Starr Piano Co., that concern's talking machine and record section is doing very well and sales are increasing with the approach of Christmas. The Starr's new "Symphonic" type talking machine has already become extremely popular. H. W. Colgar, formerly of Indianapolis, has been placed in charge of the Starr's credit department.

At the Baldwin Victrola Shop it was reported by Frank LeFevre, manager, that there is every indication that December sales will greatly exceed those of last year.

"We are fairly flooded with machine business," stated Miss Rose Helberg, manager of the local branch of the Columbia Phonograph Co. As to records, they are selling in a phenomenal way. C. E. Kramer, of the local office, of the Columbia, is just back from a trip to Louisville, where he opened up several new accounts.

L. J. Chattan, Fada Mgr., Back From Southern Trip

"General radio business conditions in the South are good," Louis J. Chattan, general sales manager of F. A. D. Andrea, Inc., reported on his return from a recent trip in that section. "In spite of a bad spot or two and the size of the cotton crop, there is optimism everywhere, I found. The feeling is that business will be very good this Fall and Winter and I discovered that the interest in radio in the South is steadily increasing."

Jordan Plant in Operation

The D. M. Jordan Co., which has been manufacturing phonographs and combination radio-phonographs in Hollywood, Fla., for some time past, suffered quite seriously from the recent hurricane in that territory, the factory building at Dania being unroofed and other serious damage done. The latest reports from the Jordan Co., however, are very cheering and despite hindrances the plant is now restored to operation again, and the company is meeting with a fair degree of success.

Evelyn Preer Making Records for Plaza Co.

Popular Numbers to Appear Under Banner and Domino Labels—Numbers by This Artist Enjoy Wide Sale Throughout Country

The Plaza Music Co., manufacturer of Banner and Domino popular-priced records, recently closed arrangements with Evelyn Preer, the contralto, whereby that artist is making a series of



Evelyn Preer

popular records for the above labels. Miss Preer confines her activities to popular programs. The first series of records made by this artist for the Banner and Domino records was well received by the trade, according to the sales department of the Plaza Music Co.

Among the songs that appear in the Banner and Domino catalog sung by Miss Preer are "When the Red, Red Robin Comes Bob, Bob, Bobbin' Along," "Breezin' Along With the Breeze," "Lucky Days," "No One But You Knows How to Love," and "Sadie Green" (The Vamp of New Orleans).

Appoint Receiver in Equity for the Eagle Radio Co.

Albert B. Ayers, vice-president, secretary and general manager of the Eagle Radio Co., 16 Boyden Place, Newark, N. J., manufacturer of the Eagle neodyne radio line, was recently appointed with Stanley R. Gedney, Jr., of Maplewood, N. J., as receiver in equity for the above company.

An action was brought against the Eagle Co. by Charles R. Payne, in which it was charged that the obligations of the company were \$352,000, but that the assets were far in excess and this was concurred in by F. M. Kellogg, president of the Eagle Radio Co. The action was brought before Judge William N. Runyon in the U. S. District Court of Newark, N. J.

According to the report, the Eagle Radio Co. is in good shape with the exception that it lacks cash to meet maturing obligations. It is planned by the receivers to operate the company along the lines that have brought it its past success and under the jurisdiction of the court will be able to meet outstanding obligations in reasonable time and attain stability for the company.

Ray Belmont Whitman Home

Ray Belmont Whitman, international patent attorney and consulting engineer, at one time connected with the Columbia Phonograph Co., has just returned from an extended tour of the world, during which he visited thirty-seven foreign countries and saw most of the great sights of this earth. In all he covered some fifty thousand miles of travel. Mr. Whitman is again located in New York, making his headquarters at the Engineers Club.



Merry Christmas

To Our Friends, Old and New

TO our old friends in the trade who have helped make this year so successful for us, and to the new friends who are now joining the big family of dealers who sell Symphonic Reproducers, we extend with gratitude our sincere wishes for a Merry Christmas and a Happy and Prosperous New Year.

Symphonic

Sales Corporation

Lambert Friedl, Pres.
370 Seventh Ave. New York

Upward Trend in Sales Marks Opening of Metropolitan Holiday Sales Season

Unusual Sales Promotion Plans of Live Dealers Stimulate Sales—Bloomingdale Bros. Feature Viva-tonal—Landay Hall Rearranges Interior Display—Other Activities

The trade in the metropolitan territory during the past month experienced two entirely different conditions. The latter part of November saw buying activity rather slow, considering the approach of the holiday season, with a day of activity followed by a day or two of slowness. In brief, it could be truthfully stated that business for November was "spotty." Starting with December, however, the trade in all its angles took an upward trend, with all types of merchandise selling in brisk fashion. Many dealers are going to feel the lack of stock before the holiday buying season is over. Some have already felt the shortage of certain models and wholesalers of the leading talking machine companies report a lack in stock of certain models.

Entertain Pupils With Orthophonic

Schwartz & Chakrin, Victor dealers, of 1304 Avenue J, Brooklyn, arranged an entertainment in which the Orthophonic Victrola played a leading part for the pupils of a public school in the vicinity of the store on December 2. The children paid a small sum for admission, the total proceeds of the affair being used to purchase a Victrola for school use. This establishment has had great success in selling the public schools of Brooklyn and has found the school authorities more than willing to cooperate in raising funds with which to purchase instruments for school use.

L. J. Saftler in New Post

L. J. Saftler was recently appointed manager of the general music store of Albert Bersin, 1253 Bedford avenue, Brooklyn, N. Y., succeeding Galbraith Perry, who has assumed the management of the West End Radio Shop, New York.

Bloomingdale Bros. Add Viva-tonal Line

The formal introduction of the Columbia line of Viva-tonal phonographs and New Process records was made by Bloomingdale Bros.' department store to its customers on Friday, November 26, when a store concert was given from noon until five o'clock. This establishment, which recently added the Columbia line, received the co-operation of the Columbia organization in making the event a success,

and the following Columbia recording stars composed the outstanding features of the afternoon's concert: Fred Rich and His Hotel Astor Orchestra; Clicquot Club Eskimos; Al Lentz and His Orchestra; Johnny Marvin, "the Ukulele Ace," now appearing in "Honeymoon Lane"; Charles Kaley, vocal artist, and Dale Wimbrow, the "Del-Mar-Va Songster," and His Rubeville Tuners, including Johnny Morris, Sylvester Aliola and Phil Adle, who gave



Crowd at Bloomingdale's Store Concert

a novelty number showing how a recording unit works in a recording studio.

William Schneider, manager of the talking machine department, was elated at the success of the concert and reported several immediate sales of instruments in addition to a large volume of record sales. The accompanying illustration shows the crowd, in the midst of which is Fred Rich's Orchestra, playing one of the numbers which they have recorded for the Columbia catalog.

Landay Hall Rearranges Department

The past month has seen an entire rearrangement of the different departments which make up Landay Hall, at Forty-second street and Sixth avenue. The record and sheet music departments, which were formerly on the main floor of the store, now occupy quarters on the second floor adjoining the radio and talking machine sections. Nine record demonstration and three music roll booths have been installed. The piano section has been moved to the third floor, a section of which has been given over to a small auditorium seating about 150, where piano recitals and demonstrations of Pana-

tropes and Orthophonic Victrolas will be given. The space on the second floor formerly occupied by pianos, now, in addition to housing the record and sheet music and music roll sections, contains three elaborately fitted and furnished demonstration and display rooms for the larger and high-priced combination units and Panatropes. The mezzanine and main floor of the store are now given over exclusively to band and orchestra instruments and small goods. J. B. Price, manager of the establishment, states that the new arrangement has already had the effect of increasing the sales of records, sheet music and music rolls and its effect of bringing the public through the radio and talking machine sections has been profitable.

Features Masterworks Series

An attractive and effective display of the Columbia Masterworks Series of records occupied the window of the New York Band Instrument Co.'s store on West Thirty-fourth street during the past month. Six different sets of Beethoven's compositions in different-colored albums were arranged on a platform in the window and behind them was shown a hand-carved portrait of Beethoven in relief on a wooden plaque. Another section of the same window was given over to a showing of the Odeon recordings of Raquel Meller, with an enlarged photograph of the world-famous artist and a framed list of the recordings on sale. J. F. Brogan, manager of the store, reports good sales of both the Columbia Masterworks Series and of the Meller records.

Tie-up With Theatre Organist

The opening of the Paramount Theatre, at Times Square, last month was utilized by the Rudolph Wurlitzer Co., on Forty-second street, to call attention to the Victor recordings of Jesse Crawford, who plays the Wurlitzer organ in the new theatre and who is a popular Victor artist. A large photograph of the theatre was shown, together with a picture of the artist and a list of his latest Victor recordings.

Opens Basement Record Department

A new record department was opened the latter part of last month in the basement of the John Wanamaker store, with Harmony records, made by the Columbia Phonograph Co., featured. This department is advantageously situated so that visitors to the Wanamaker establishment must pass by it in going from the old to the new store and should prove an excellent outlet for Harmony recordings. The full Columbia line of Viva-tonal phonographs and Columbia New Process records is carried in the regular music department.

Canvassing Sells Radio

Canvassing by truck throughout the Williamsburg section is proving a profitable method of selling radio equipment for Silver's Music Shop, 316 Roebling street, Brooklyn, which carries a full line, including the following makes: RCA, Stromberg-Carlson, Atwater Kent, Freed-Eisemann and Fada. G. I. Ray, manager of the establishment, states that in nine cases out of ten when a radio receiver is placed in a home for demonstration a sale results.

C. Bauer Sons, Inc., Adds Victor

C. Bauer Sons, Inc., 740 Broadway, formerly Stultz & Bauer, for many years an exclusive piano house, was recently granted the Victor agency and is putting a vigorous campaign behind the Orthophonic instruments and records. Large advertisements in the daily papers have announced the addition of the new department and the reputation and prestige of the concern and the many friends it has made in selling pianos have brought a brisk business during its first month as a representative of the Victor line of machines and records.

Buys Montauk Music Shop

A. E. Henderson has purchased the stock and business of the Montauk Music Shop, Rockville Center, L. I., N. Y., and is continuing the business at the same location under the same name.

Ask for **"IRON HORSE"** Insist on

PADDED PROTECTION COVERS
OLIVE DRAB DENIM

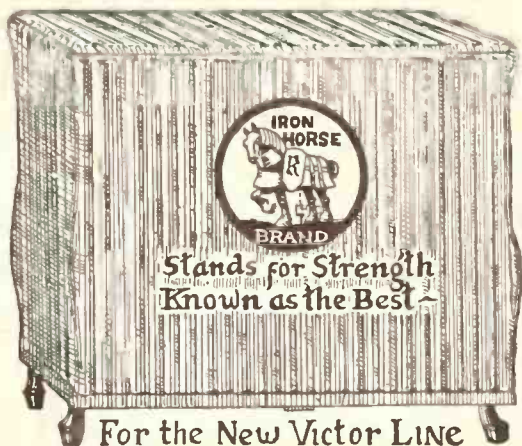

All Styles Padded Covers, Form Fitting, with Strap and Buckle Attached. Also Styles for Every Make of Talking Machine or Radio.

**Let It Rain
Let It Pour
Let It Snow**

Will your phonographs be thoroughly protected in delivery during the winter season? Now is the time to think of moving covers. Write your jobber or direct to us today.

Reliable Manufacturing Standard Always Maintained

A. L. REACH TEXTILE CO., Inc.

Mill Contractors COTTON GOODS
224-226 EAST 42ND ST.
MAIN OFFICE AND SALESROOM

Manufacturers
CANVAS SPECIALTIES
NEW YORK, N. Y.

Just One

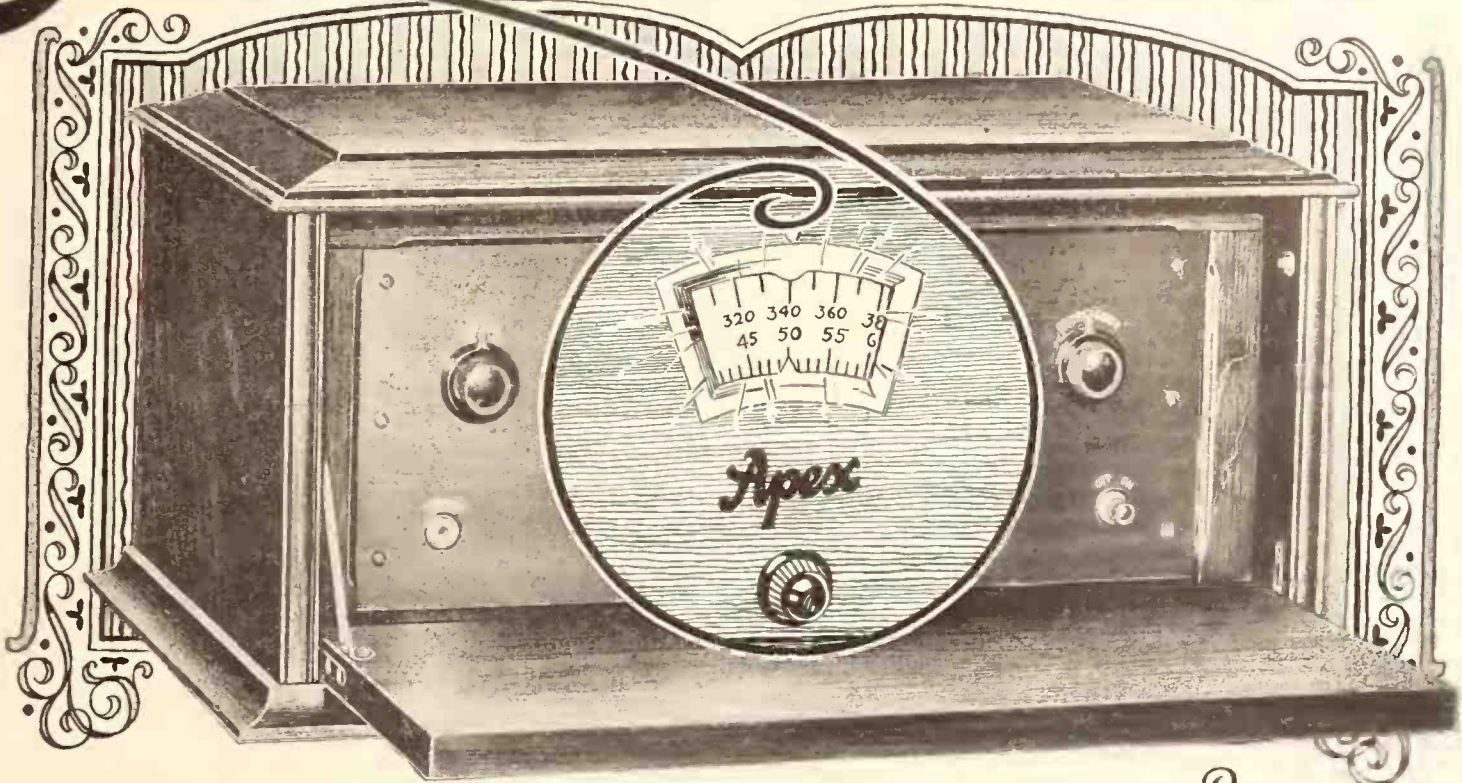

THAT the new Apex Six will be one of the most popular sets on the market this season and for many seasons to come — is a foregone conclusion.

Consider these important improvements. Patented Compensator (patented in 1924 and withheld from the market until its merit had been established beyond all question)—one dial control—impedance coupled—the entire sphere of radio at the command of the turn of a single dial—all distortion eliminated—illuminated dial—automatic filament control.

This notable receiver is housed in furniture worthy of its quality and designed in combinations which provide a wide selection on small investment.

For example—receiver No. 6 combined with cabinet No. 100 makes set No. 106.

Sixteen years of unimpeachable manufacturing activities vouch for the integrity and stability of the Apex organization and for the value of Apex products.

With but few exceptions Apex dealers of yesterday are Apex dealers of today. Conclusive evidence that Apex products give satisfaction and the Apex policy proves profitable to dealers. Apex sets have never been "junked" or price slashed and never will be. Progressive dealers are invited to write for particulars regarding liberal Apex dealer franchise.

Patented Compensator

Apex Electric Mfg. Co.

Dept. 917, 1410 W. 59th St.

Chicago



APEX MODEL No. 106 Without Accessories—\$175



APEX MODEL No. 5 Without Accessories—\$85

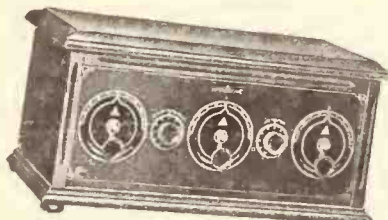

APEX SUPER 5 Without Accessories—\$80



APEX MODEL No. 116 Without Accessories—\$210

Apex



Broadcasting Situation Receives the Attention of Metropolitan Retailers

Talking Machine and Radio Men, Inc., in Resolution Call for the Clearing of the Broadcasting Tangle—Hear Interesting Talks—See Exhibit of Radio Line—Discuss Legislation.

Ways and means of controlling the broadcasting situation to the end that the present confusion on the air be ended through the intervention of Federal legislation was the chief topic of discussion at the monthly meeting of the Talking Machine and Radio Men, Inc., the dealer organization of New York, New Jersey and Connecticut, held on Tuesday, November 30.

Irwin Kurtz, president of the Association, presented to the members for their consideration a resolution on the subject adopted at a recent meeting of the executive committee. The resolution was adopted by the members unanimously. Briefly summed up, it asks that

the channels of radio communication should be perpetually maintained and controlled by and for the people and should never be permitted to become private property; that the use of the channels of radio communication should be controlled by Federal license, issued for a minimum of three years and a maximum of five years, and subject to revocation for any violation of the law; that a sworn statement of the ownership of the broadcasting station be filed with the proper agency once every six months; that the authority to issue licenses, assign wave lengths and call letters, and to establish power limitations, etc., be vested by law in some executive branch of the Federal Government, maintained by funds appropriated by Congress; that licenses shall not be transferable; that broadcasting stations shall retain the right to determine the character of all material broadcast; that there be no tax levied on radio receiving sets or parts or on broadcasting equipment, and that a copy of every speech made over radio be filed with the proper authorities within forty-eight hours after its delivery and kept on file for a year.

Following the adoption of the resolution, Congressman Sol Bloom, a former music dealer, spoke on the radio situation and the pending legislation at Washington. He commended the Association on the resolution it had adopted and urged the dealers to send their representatives to the hearings on the bills now pending, declaring that they were in a position to state what the public wanted, and not allow the manufacturers and broadcasters to carry on the campaign for legislation alone.

Another matter which received the attention

of the Association was the law introduced by Assemblyman Alterman and which went into effect on September 1, which serves to complicate and make almost prohibitive the expense of repossessing musical instruments, furniture, etc., sold on instalments and on which payments have lapsed. The bill expressly excludes automobiles from its provisions, due to the fact that automobile dealers were cognizant of it and took immediate action. Now the members of the music trade, together with the furniture dealers, are working to have the bill repealed. Having been passed, the details of the measure are more or less familiar to members of the trade, and steps have been taken whereby retailers will be advised immediately of the introduction of other measures in Albany that are calculated to affect the interests of the industry.

G. C. Anderson, general manager of the Hartman Electrical Mfg. Co., manufacturer of the Hartman line of radio equipment, which was on display, spoke briefly and introduced Edward H. Loftus, consulting engineer, who explained the outstanding features of the Hartman syn-tonized "single-six" unit.

President Kurtz explained proposed changes in the by-laws of the Association, which will be voted upon by the members at the next meeting, which will be held January 12. The chief of these changes provides for the election of sectional vice-presidents, three in Manhattan, one in Kings County, one in New Jersey, one in Bronx County and one to represent the manufacturers and distributors. These vice-presidents will have to do with regional matters and will displace those now in office and who represent groups carrying the same lines of talking machines. Byron Forster, chairman of the entertainment committee, appointed the members of the entertainment and year-book committees for the 1926-27 season. A resolution of sympathy to Sol Lazarus on the loss of his mother was passed.

The new SONOCHORDE CONE

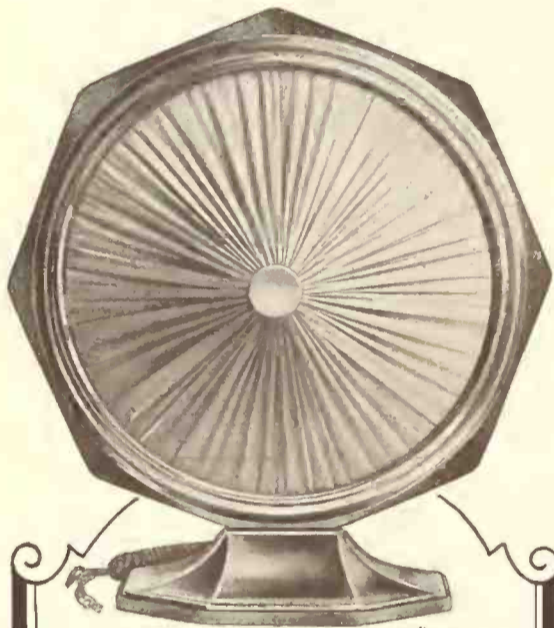

\$25.00

Now is the Time!
to Order

Many dealers could have sold two or three times as many Sonochordes this Christmas—if they'd had them. We could not begin to fill the unprecedented demand, although we tripled production. Far sighted dealers will insure January deliveries by ordering now.

[Sonochorde popularity is due entirely to its obvious pre-eminence when compared with other good speakers. Just hear one!]

BOUDETTE MFG. CO.
CHELSEA MASS.
HASTINGS ELECTRIC SALES CO.

Factory Sales Agents

42 Binford St. S. Boston, Mass.

BACK VIEW FLOOR STANDARD MODEL WALL MODEL



Note how the back of every Sonochorde is protected against possible injury.

Equipped with heavy cord and decorative tassel. Price \$27

A design of unusual distinction. Price with cord \$35

Remarkable Growth in Output of Nat'l Lead Battery Co.

Progress of This Institution Another Romance of Modern Industry—Many Plants Operated

Another romance of modern industry, that of a firm rising from obscurity to national prominence in a brief span of years, is very evident in the battery industry. In 1917 the National Lead Battery Co., with general offices at St. Paul, Minn., then organized under a different name, first began the manufacture of storage batteries.

From that time on every obstacle, lack of capital, general financial depression, and even a disastrous fire which burned the plant to the ground, seemed pitted against the firm's struggle for success. But from a humble plant with a handful of employes, the company has grown until it now has several hundred employes in its five factories and five factory-operated branches scattered throughout the United States. As a result of this company's phenomenal growth, it now ranks among the older leaders in the industry from a production standpoint.

The firm was engaged in the battery business originally in 1910, when from that time until 1915 it was distributor in the Northwest for one of the largest-selling batteries on the market. The National Lead Battery Co. began the manufacture of batteries for the first time in 1917 in Minneapolis, and in 1919 moved its main plant to the present address in St. Paul. In the Fall of the same year the factory was completely destroyed by fire. The next two years were occupied with the slow work of rebuilding the factory and the organization, and in 1922 production of batteries was first begun on a large scale.

With a meager capital contributed by its president, L. J. Shields, and a few others, the company first started on its climb to success. At

the end of the first year a dividend of \$10,000 was paid on the small original investment and \$20,000 at the end of the second year. A total of 65,000 batteries was marketed during 1922; 120,000 in 1923; 229,000 in 1924; and 425,000 in 1925. During 1926 production is scheduled on the basis of 638,000 batteries, and the end of the year will probably show the total production well over this figure.

The company now operates factories at St. Paul, Chicago, Kansas City, Los Angeles and Cincinnati, branches being located at Kearny, N. J.; Baltimore, Md.; Atlanta, Ga.; Dallas, Tex.; Oakland, Cal., and Portland, Ore., while several other points are now being considered as logical locations for additional expansion.

The latest National product is the Homepower "A" Unit, a combination of "A" battery and charger in a single compact unit, with a container of a non-corrosive compound. The "Homepower" is made in three types to fit various radio receiver requirements.

Phil La Brie to Work With Fada Australia, Ltd.

At the request of Fada Australia, Ltd., Phil La Brie, Fada representative in Australia, has been temporarily assigned to serve that organization in installing for the new Australian firm the same system of controlling distribution as is in effect in the leading distributing circles in the United States. In announcing this move, F. A. D. Andrea, president of Fada radio, stated that Mr. La Brie is fully conversant with radio trade procedure as practiced by outstanding American manufacturers, as well as the distributing set-up for radio. Fada Australia, Ltd., was recently organized with a capitalization of \$250,000 to handle Fada products in Australia and Tasmania, with headquarters at Adelaide, South Australia.

A Merry Christmas



Santa Claus Says:
"Brach Has a Great Line of **RADIO GIFTS**
Which Every Dealer Should Sell"

(1) New!
Brach Controlit

Here is the gift of gifts to owners of radio sets. Controlit makes any radio set a light power-operated set, eliminating all switches from "B" Battery Substitute and Trickle Charger and placing complete, automatic control in the set switch.

Retails for \$6 in U.S.A.

(4) Brach Shock-Proof Radio Plug

Should be on the radio gift list—a Shock-Proof Plug that gives perfect electrical contact, withstands high voltages and is easily connected or released. Retails for 50c.

(5) Brach Master Aerial Outfit

Here is one of radio's big sellers—a complete antenna—every needed part—in one package—including a Brach Lightning Arrester. A corking gift for present or prospective radioists.

Price \$3.50; others up to \$5.50

(2) Brach Lightning Arrester

Brach Arresters dominate the field, making it unnecessary to urge dealers to carry the Brach line complete. All Brach Arresters are backed by a \$100 Insurance Guaranty. Prices \$1 to \$3.50.

(3) Brach Extension Cord Connector

This simple device—in one piece; made of pure Bakelite—readily connects speaker or head set cord with extension cord. It will be welcomed in the Christmas "Stocking."

A 50c Article

(6) NEW!
Brach Totem-Pole Antenna

Something that meets a demand long unfulfilled—you'll sell lots of them.

An indestructible, weather-proof antenna—like a flagpole with 100 ft. of wound wire. Can be placed on flat or gable roofs, the side of the house, the window ledge; on a boat deck or tent pole. Does away with unsightly make-shifts. Insures fine tone and clarity. A great Christmas gift, especially for those living in apartment houses, hotels, etc.

Price \$10

(7) NEW! Brach Drip-proof Hydrometer

Another trade winner for radio dealers! Better order generously.

To the Brach Hydrometer, with the famous Chaslyn Balls, is combined the drip-proof feature, eliminating the danger of battery acid ruining rugs, floors and clothing.

It will make a strong appeal to your customers. Be ready for them.

Retails at only \$1



1



2



3

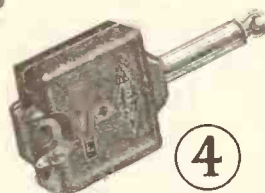

4



7

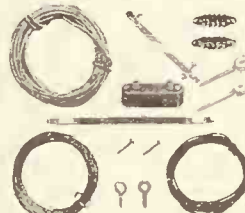

5



6

Brach

Radio Products

L. S. BRACH MFG. CO., Newark, N. J., U. S. A.

L. S. BRACH OF CANADA, Ltd., Toronto, Can.

Retailers in the Richmond Territory Order Heavily for the Holiday Rush

Dealers in the Coal District Prosperous as a Result of Wage Increases of Miners—Cotton Price Slump Affects Sales—A. Z. Lilly's Music House Celebrates Anniversary

RICHMOND, VA., December 7.—Except in sections where business is affected by the cotton situation, phonograph dealers are reported to be stocking up well in anticipation of a good Christmas trade. Slump in the price of cotton due to overproduction of the crop has made merchants in cotton-producing areas slow to place orders with jobbers and it is believed that they will continue to mark time until there is appreciable improvement in the situation.

Material increase in wages of coal miners in West Virginia, last month, has boosted trade in that territory, according to reports from dealers throughout the section.

John S. Ramos, salesman for Lyon & Healy, of Chicago, a former Richmond boy, is visiting relatives here. He is a son of the late Manly B. Ramos, prominently identified with the Richmond music trade for many years.

A. Z. Lilly's music house, of Beckley, W. Va., which recently observed its fifth anniversary in its new store, reports that the miners in that territory have been spending much money with them since they got their increase, especially in phonographs and records. Incidental to its celebration, the Lilly store staged a voting contest in which the school voted the most popular in town was awarded a talking machine.

The Biggs Music Co., of this city, announces that it is now showing a complete line of Columbia New Process records and also the new Viva-tonal Columbia.

Christmas buying in Richmond and other

cities in this territory where banks distribute Christmas savings checks is expected to be stimulated greatly by the distribution of this large sum of money.

Goldberg Bros., of this city, are no longer distributing Pathé machines, but they are still handling Pathé records. They report that they are well stocked up with Artone portables as well as their own lines of machines in anticipation of meeting orders for the holiday season throughout the territory which they cover.

J. K. Fletcher, manager of the Corley branch store in Petersburg, Va., recently sold two \$900 Hyperion Orthophonic models and one Borgia model in the Victor line which sells for \$1,000. The general run of the trade, he says, prefers the \$300 Credenza to all others, and he is placing quite a few of these.

John H. Cowan, salesman for Goldberg Bros., traveling Virginia, Maryland and parts of Ohio and Pennsylvania, is back in his territory following a honeymoon tour spent in Kentucky, native State of his bride, who was Miss Catherine Busse, of Richmond, before marriage. He is a son of James Cowan, of the James Cowan Co. music house, Richmond, handling Columbia and other lines.

G. E. Moss, of the phonograph department of Lee Fergusson, Victor dealer, plans to spend Christmas in Chase City, Va., his former home town. O. F. Grady, manager, is back on the job after being laid up for a week or so with an attack of grippe.

Akron-Canton Trade to Cash in on Distribution of \$1,500,000 Christmas Funds

AKRON-CANTON, O., December 8.—With Christmas only a few weeks distant, quickened demand is noticed for talking machines, radio, records and, in fact, all kinds of musical merchandise. The month of November was a fair month, dealers said, but now that the holiday buying season is on in earnest, all of the larger stores are thronged daily with prospective customers. Release of almost \$1,500,000 in Christ-

mas savings, in this district, has been responsible for the spurt in sales.

A week's run of Rose Marie, at the Grand Opera House, Canton, is responsible for improved demand for phonograph records of the song hits of the show, dealers said this week. Sheet music sales also profited by the appearance of the show.

Charles A. Lohman has been made manager

of the phonograph department of the Anderson Music Co., Dayton, O. This concern last week observed its fiftieth anniversary by holding a week of special events.

Stimulated record sales resulted from the personal appearance at Land O' Dance, Canton, of Whitey Kauffman and his Victor Recording Orchestra.

"Radio merchandising competition is so keen that the authorized music dealer has to move quickly to profit these days," said Earle G. Poling, of the Earle G. Poling Music Co., Akron. "Higher-priced machines, which the side street dealers are unable to come near comparing their merchandise with, are selling best," he said.

George C. Wille, head of the George C. Wille Music Co., presided at the annual banquet and meeting of the Canton Radio Dealers' Association held recently in the Canton Club. A detailed report was given of the recent annual radio show sponsored by local radio and music houses and the promotion was found to be highly successful. It has been decided to hold another radio show next Fall.

J. E. Anderson has been named manager of the radio section of the new Strauss-Hirshberg department store, Youngstown, opened recently to the public.

Sacramento Music and Radio Trade Ass'n Meets

Eighty-five Members of Trade Listen to Talks on Important Problems

SACRAMENTO, CAL., December 7.—The Music and Radio Trades Association of this city held a meeting last month, which was attended by eighty-five members of the music and allied trades. A number of interesting talks were given, including one by Shirley Walker, president of the Northern California Music Trades Association, on general aspects of the retail music trade. Other speakers included John Rapp, vice-president of Earl Wright, Inc., and M. De Lyons, vice-president of Ernest Ingold, Inc. These speakers were guests of the Association, being visitors from San Francisco. A number of members also spoke on different phases of merchandising and servicing musical instruments and radio receivers. Ellas Marx, head of the Association, presided.

Charles L. Grinnell, of Grinnell Bros., Dies

Charles L. Grinnell, junior director of Grinnell Bros.' music house, died in Harper Hospital, Detroit, Mich., on Friday, November 12, after a six months' illness. Mr. Grinnell was forty-nine years of age and had been connected with Grinnell Bros. for twenty years, being the son of the late I. L. Grinnell, founder of the business. Funeral services were held on Monday, November 15, with the interment in Roseland Park Cemetery. Mr. Grinnell is survived by his widow, Mae, and two children, Ira L. and Beryl.

Advocates Development of Short Wave in Broadcasting

Owners of new broadcasting stations should develop the great short-wave field, doing their own prospecting of the ether, and pioneer broadcasters should be protected against piracy, Powel Crosley, Jr., prominent radio manufacturer and owner of broadcasting station WLW, in Cincinnati, said in a recent interview:

"Of course the most serious problem is legislation through which there will be established some authority to control the wave length assignment of these stations and to police the air in such a way that its use will be most beneficial to the public," he said.

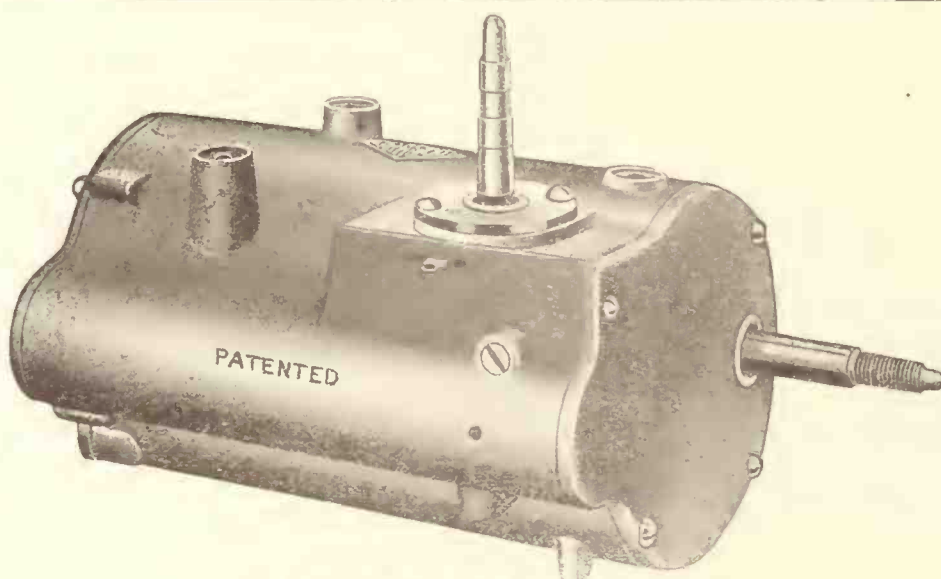

FOR SALE

Phonograph Motor Manufacturing Equipment

Complete with jigs, dies, die-casting equipment, blue prints and patent rights. Equipment designed to manufacture the famous Valiquet (shown above), the only enclosed, dust-proof, three-spring motor, which plays six ten-inch records with one winding.

This equipment can be purchased at a figure so attractive as to make the manufacture of this famous enclosed motor a most profitable investment.

For further information address

The Talking Machine World—Box 1584
209 South State Street, Chicago, Ill.

The 100,000

mark has been reached in the sale of

ULTRA (phonic) Reproducers

—and this in less than six months time

THIS is a tribute not only to the exceptional merit of this high quality product but also stands as proof that the progressive music merchants are quick to recognize superiority.

Progressive dealers everywhere have made and are making real profits on the sale of Audakco products, with the knowledge that they are giving their customers the very best the market affords.

Beginning with the New Year (January 1, 1927), there will be further additions to Audakco products — which will mean still more profits to our ever increasing number of retailers.



The Standard by which all reproducers are judged and valued!

\$850
Retail

All Ultra Reproducer diaphragms are of a scientifically proportioned aluminum alloy—as thin as a human hair. Nothing else will meet the exacting requirements of the new electrical recordings—and remember the better these records are reproduced, in the home, the more of them you will sell.

The AUDAK COMPANY, Inc.

Makers of high grade Acoustical and Electrical Apparatus for over 10 years

565 Fifth Avenue, New York, N. Y.



Royal Blue Model—No. 540; H, 45; W, 25; D, 14.
Panel 9 x 20.

A magnificent cabinet. Walnut only. Substantial construction. Beautiful dull-rubbed finish. Hinged, silk-lined loud speaker grill. Receiver compartment fits any standard set. Roomy lower compartment for batteries, accessories, etc.

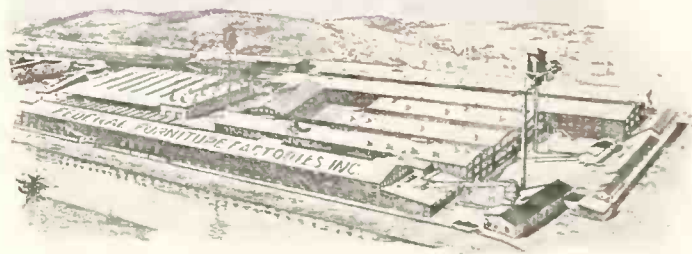

One of the giant plants of the Federal Furniture Factories, Inc. Your guarantee of uninterrupted production of Cabinets by Irving.

The Cabinet Sensation of the 1927 Season

Beautifully Made . . . Beautifully Finished

Popular Design . . . Enduring Construction

GUARANTEED BY

THIS RESPONSIBLE ORGANIZATION

The Perfect Cabinet for the

ATWATER KENT COMPACT—And Other Models

THE New Federal Radio Cabinet is one of those rare pieces of merchandise in which every single detail dovetails so perfectly that tremendous sales can be the only outcome. Design is one of those happy combinations of line and form which instantly hits a widespread popular chord. Appropriate for the Atwater Kent Models and practically all other makes. Size exactly meets popular demand. Finish harmonizes with the prevailing furniture mode of today.

It comes to the market at just the moment when the highboy type of radio cabinet has won the attention of millions of people.

IN QUALITY IT HAS NO SUPERIOR.

And because it is produced on a *quantity production basis it can be sold for at least \$10 to \$20 less than any similar cabinet produced today.*

BIGGER PROFITS—Start Making Them Now!

The New Federal Radio Cabinet is making new sales records because it represents *exceptional value*. The consumer knows *value*. He *wants* value. Put it on display in your store and watch your sales *grow!* Order from your jobber or write us direct to-day.

ROCKFORD SALES CORPORATION

Division of Federal Furniture Factories, Inc.

206 Lexington Avenue . . . New York City

Cabinets by Irving

The new radio law will probably make available wave lengths for broadcasting stations as low as 150 meters. What will be the feeling of a purchaser of a high priced set who cannot hear these low wave lengths? We know of only one radio set regularly manufactured which will take wave lengths from 150 to 550 meters without changing. It is the 1927 model ten tube Zenith DeLuxe operating without outside antenna or loop and yet gives great power and distance. It is the highest grade, most selective and most sensitive receiver made and is the pride of its makers, the Zenith Radio Corporation, 3620 Iron Street, Chicago, Illinois.

Filmo Home Motion Picture Camera Popular With Trade

Many Music-Radio Stores Taking It On—How the Bates Radio Corp. Feature This Line

That the Filmo home motion picture camera manufactured by the Bell & Howell Co., Chicago, is firmly establishing itself in the stores of music and radio dealers throughout the country is the information gained from the reports of representatives of the firm scattered throughout the country. Many retailers have been at-



How Bates Gets Publicity on Filmo Line
tracted by the sales possibilities of this home entertainment device and have added it to their phonograph and radio lines, are soliciting old and new customers, and building up a business which will stand them in good stead during the Spring and Summer months, as well as in the Fall, when motion picture cameras are in demand as holiday gifts.

The accompanying photograph shows how one aggressive dealer, the Bates Radio Corp., of Milwaukee, Wis., advises the public in that city that the store handles the Filmo camera. The truck carries a reproduction of the camera, showing exactly how it is used, with the caption: "What you see you get with Filmo," printed to the left of the illustration. Since the truck is in daily use in making deliveries to various parts of the city, the firm, which also handles the products of the Radio Corp. of America, secures a tremendous amount of valuable publicity at a comparatively small cost.

Hazeltine Corp. Files Suit Against E. B. Latham & Co.

An action alleging infringement of the Hazeltine neotrodyne patent has been filed against E. B. Latham & Co., New York, radio distributors, by the Hazeltine Corp., and Independent Radio Manufacturers, Inc., in the United States Southern District Court in New York. The bill of complaint alleges that the defendant "has infringed upon patent No. 1,533,858, particularly claims 1, 2, 5, 9, 12, 14, 16, by selling and causing to be sold and used radio receiving apparatus embodying the inventions of said letters patent manufactured without right of license by the Atwater Kent Mfg. Co." The plaintiff asks for a permanent injunction and an accounting as well as payment of damages sustained.

An Artistic Fada Poster

A new poster featuring the shielded construction of Fada radio has been sent to the trade by L. C. Lincoln, advertising manager of F. A. D. Andrea, Inc. This is part of a comprehensive list of dealer helps prepared for Fada franchised dealers. The chassis of the Fada Eight is pictured against a shield in the familiar orange and black with the caption "Shield of Protection," the whole being dominated by the slogan "Fada Harmonated Reception." Fada dealers are also using an attention-getting window strip of black on orange to which the legend "Here now—Hear it Now" lends an appealing lilt.

The Wm. H. Keboch Piano Co., 111 North Sixth street, Reading, Pa., which recently added the Columbia Viva-tonal line, is making a strong direct mail campaign to push the line.

Milwaukee Dealers Busy Supplying the Demands of the Early Holiday Shoppers

Trade Facing Annual Holiday Shortage of the Most Popular Instruments—Many Radio Sales to Gift Buyers—Victor Sales Increase—Wide Trade Interest in Recently Formed Association

MILWAUKEE, Wis., December 6.—Holiday business opened up very well according to reports from Milwaukee radio and phonograph jobbers, who add that the usual holiday shortage of merchandise is being experienced.

Radio Sets for Gifts Are Popular

"It looks as if everybody is set on buying a radio for Christmas," said Sidney Neu, manager of the radio department of Julius Andrae & Sons Co., RCA distributors, in Wisconsin. "A little while ago dealers seemed to be holding back in their orders and things were rather quiet. Things have opened up now with a bang, and we are being more than rushed with the demand."

Nelson-Goodwin Radiola Shop, recently opened in Milwaukee at 253 Twenty-seventh street, will carry the Radiola, Crosley, Howard and Radiodyne lines, for which the Andrae Co. is the Wisconsin representative. The Lincoln Electric Service Co., 1390 Green Bay avenue, is also going into the radio business and will handle the lines of Julius Andrae & Sons Co.

Yahr-Lange, Inc., Busy

Fred E. Yahr, president of Yahr-Lange, Inc., wholesalers for the Sonora in Wisconsin and Michigan, states that there is an extremely active demand for Sonora radios and phonographs throughout this territory. "We are very busy filling our orders," said Mr. Yahr, "as the holiday sales have increased our already large ordinary demand."

According to Mr. Yahr the Super-Ball antenna continues to show almost phenomenal results. Orders are pouring in from all parts of the United States, he says, and a large amount of business is received from foreign countries. Sonora phonographs also are in increasing demand, according to Mr. Yahr.

Active Brunswick Demand

Carl Lovejoy, Brunswick representative in Milwaukee and southern Wisconsin, says that the Brunswick Panatropé is selling at a "wonderful" rate.

"Dealers are enthusiastic over the Panatropé and the Panatropé Radiola," said Mr. Lovejoy. "Business around the State has been very steady, and business conditions throughout the terri-

tory seem to be good." The high-priced phonograph unit has interested the dealer in making sales. This fact may be proved from the statements of dealers that the phonograph is one of the basic profit-making factors of their business, and also by the fact that phonographs at \$1,100 and \$1,200 are in the greatest demand.

Victor Sales Increase

According to Harry Goldsmith, secretary of the Badger Talking Machine Co., jobber of the Victor, business in the entire territory is good. "We are enjoying a very fine business," said Mr. Goldsmith, "not only in Milwaukee but throughout the territory. People continue to show great interest in the new models, and electrically recorded records have also played a prominent part in selling the public on the merits of the new models. Some difficulty in getting enough Victrolas to adequately supply our dealers is being experienced, a matter which the holidays have made still more difficult. The new model 860 combination Electrola and Victrola is being very well received by the trade.

Mr. Goldsmith states that the Badger Talking Machine Co. has just issued a chart showing the different styles of mainsprings for the different Victrola models.

Interested in New Association

Radio and phonograph jobbers are showing great interest in the Wisconsin Association of Music Merchants and in the Milwaukee division of the association which has recently been formed. As members of the Association they are active on the various committees, and find the opportunity of making many desirable contacts. The Association besides affording advantages of acquaintance, also offers jobbers the opportunity of assisting the retail dealer, and of coming into closer contact with him. The Association has already started on a very ambitious program for the material betterment of music throughout the State and in Milwaukee.

Bert E. Sutton, of the Music Shop of Springfield, Ill., has been arousing a lot of interest in the Victor Orthophonic and new Victor records through demonstrations which have been well attended.

Televocal QUALITY TUBES

Dependable and a Technical Triumph



A RADIO TUBE that is non-microphonic — won't short. Sold in matched units; tested, balanced and plainly marked detector, radio frequency or audio frequency.

DEALERS AND JOBBERS

Ask for particulars on this new and better radio tube that costs no more.

Televocal Corp'n.
67 A FIFTH AVE. — NEW YORK

Dealer's Name.....

City..... State.....

Jobber's Name.....

City..... State.....

Roy E. Forbes Tells How the Victor Co. Introduced Orthophonic Line to Trade

Article in Printers' Ink, Interview With Director of Sales of Victor Co., Describes How Carefully Carried Out Plans Resulted in Wide Interest in New Instruments

How the Victor Talking Machine Co. through advertising and a carefully thought-out merchandising plan successfully introduced the new Orthophonic line in spite of the fact that dealers' stores were loaded with old models, and wholesalers' warerooms also were filled with them and the factory itself had a huge number of completed and partially finished instruments on hand, is told in a most interesting article entitled "The Story of the Victor Come Back," that appeared in a recent issue of Printers' Ink. The article is based on an interview by Roland Cole with Roy E. Forbes, director of sales of the Victor Co.

Mr. Forbes points out that months of executive deliberation preceded the change, and although work on the new Orthophonic Victrola did not start until the end of June, 1925, the new instruments were delivered to dealers' stores by the last week of October of that year. By that time, too, through the merchandising plan arranged by the Victor Co., stocks of old style Victrolas were practically cleared from the floors of retail stores so that the dealers could concentrate all their efforts on promoting sales of the new instruments.

A remarkable feature of the entire situation is the fact that from a heavily depleted sales volume the Victor Co. reached the point where factory facilities were inadequate to meet demands in the brief period of a half year.

On the day that the Victor Co. finally decided on the plan to dispose of the old instruments to aid the dealers in getting rid of their stocks all distributors were advised of the fact. The Victor Co. held back its own stock of old style Victrolas and quoted no prices on these until distributors and dealers were able to move theirs. The dealers and distributors decided that half the regular list price was the proper level at which the old instruments could be sold. The Victor Co. accordingly took this figure as correct and revised the prices on the old instruments it had on hand. How the dealers moved the obsolete styles is now history. Many dealers, points out Mr. Forbes, suffered a loss while others quickly disposed of the stock on hand with the loss incidental thereto, and then

promptly replenished on the basis of the new prices and were able to come out of the situation with a normal profit.

"The absolute necessity of disposing of the old style Victrolas at prices acceptable to the public in order to clear the way for the new Orthophonic will be clear when I explain that



Roy E. Forbes

the latter is a new talking machine in every sense of the word, constructed upon an altogether new principle, different within and without, having no relation or semblance to the old Victrola," said Mr. Forbes.

Mr. Forbes also points out the fact that an entirely new method of recording accompanied the introduction of the Orthophonic line, and he goes into considerable detail in describing the process. In discussing the actual introduction of the new instrument and record and the problems that had to be faced, Mr. Forbes said:

"Everyone who has had any experience with musical people knows that every community has its bellwethers among local musicians. Inform them of news first, or acquaint them with innovations or recent developments, before such knowledge is released to the general public, and the most influential tongues in the community are set going.

"With this in mind, we planned a series of advance demonstrations beginning at Philadelphia and the more important musical centers of the country, and including every community where the local Victor dealers could be persuaded to undertake, with our co-operation, the direct-mail work necessary to make such an affair successful.

"The important thing was to compile a list of names of a town's socially influential people. This varied in different towns. In cities and towns where symphony concerts were given, it included a list of the regular subscribers; wealthy people who usually lend their names to the promotion of musical events; society leaders; those in high circles in the town's religious and educational affairs; city officials, the mayor, or other prominent people like merchants, bankers and the heads of women's organizations. A special form of invitation, which we prepared, was mailed over the dealer's signature to this special list.

"These advance demonstrations were uniformly successful—successful to a remarkable degree. In order to preserve the right atmosphere in connection with them, we held back our newspaper announcements for the public demonstration which followed almost immediately. The psychological effect of the advance demonstration was apparent in the interest with which the general public flocked to the general demonstration.

"We called this general demonstration 'Victor Day' and the date was November 2, 1925. The event was heavily advertised, nationally and locally. A tremendous public interest was created in our new instrument. 'Victor Day' proved successful everywhere.

"Our local and national advertising was supplemented with a great amount of personal work on the part of local dealers—talks with prospects and customers, work over the telephone and special literature sent through the mail to selected names. All of this had the effect we sought, namely, that of creating something of a sensation in each community. Had the effect been anything short of this, the bringing out of the new Orthophonic Victrola might have passed with a mild ripple of interest on the part of talking machine owners and prospects and then subsided. Something extraordinary was needed to arouse public interest to a pitch of excitement and keep it there.

"With the two demonstrations successfully staged, our sales problem became one of keeping it there, which we have been doing with one of the most thoroughgoing advertising and merchandising campaigns in the history of the company.

"So successful was this tremendous advertising and merchandising effort that within two weeks after 'Victor Day' we had more orders on our books than we had ever had at one time in the past. These orders were placed for Christmas delivery, then only four weeks away. At no time since the new Orthophonic was introduced has our factory been able to catch up with orders.

"It should be borne in mind that our merchandising and advertising campaign is really two campaigns, or a campaign in two sections; first, introducing the Orthophonic Victrola with a sufficient number of records made by the new method to permit of demonstration, and, second, introducing the New Orthophonic Victor Record. The last-named campaign was inaugurated with page and half-page advertisements in newspapers all over the country, beginning on October 21. Records made by the new process have been manufactured since the new Victrola was introduced, though the advertising announcement on them had to be withheld until Orthophonic Victrolas could first be put into distribution.

"Our national campaign announcing the Orthophonic Victrola began during the first week of November, 1925, with pages and half-pages in principal newspapers and color pages in a list of popular weekly and monthly magazines, besides announcements in trade journals. Despite the fact that we have never been able to catch up with our orders on the new cabinets and records, our advertising campaign is being continued at full schedule.

"Supplementing our national periodical campaign, our direct-mail literature for dealers and consumers is being completely reorganized. These features include our dealers' magazine, 'The Voice of the Victor,' our monthly supplement of new records, which has just been entirely remade from a typographic standpoint, and a long list of display material for the dealers' store and literature for mail and counter distribution featuring the new line of cabinets and the steadily growing list of new recordings.

"The developments of our merchandising campaign have necessitated many radical changes in our sales organization. We have been obliged to put into effect a new scheme of field representation to keep distributors and dealers in close touch with the policies of the company. The United States is now divided into five sales areas, with a district sales manager in charge of each, located in the field.

"What we are trying to do in the Victor sales department is to help our distributors keep in the closest kind of touch with retailers and thereby improve the quality of service available to the consumer. The great lessons we are now endeavoring to teach the retail dealer are (1) open-mindedness in his attitude to the public and toward suggestions brought to him from manufacturer and distributor; (2) clean stocks, which is only another term for the intelligent application of the principle of rapid turnover; (3) quality as it applies to the merchandise and service offered to the public, and (4) sustained effort in the use of scientific merchandising and advertising to hold the advantage he now has.

"The success of our campaign has been due to the plan, i. e., that every detail was worked out in advance; to the speed with which the plan was executed; the co-operation which we gave to, and received from, distributors and retailers, and the extent and quality of our advertising. As a commercial achievement, these points are significant only as the commodity has merit."

POINT No. 14 Choosing a Tested Mainspring

A tested mainspring has a centre almost full of loose coils which is the result of its being wound as tight as possible to find any irregularities in the strength and temper. These centre coils should not be too close together but with an even distance between them, and the curve should be one steady sweep, without any kinks, right to the inner end of the spring.

Unfortunately, there are a good many users who prefer their Mainsprings with just two or three loose coils in the centre, because they look better, but as this style of mainspring has not been tested they are not to be relied upon.

Each and every Vulcan Mainspring has to pass a rigorous test before we are satisfied, and every Vulcan mainspring is guaranteed against faults of all kinds.

**USE VULCAN
MAINSPRINGS**

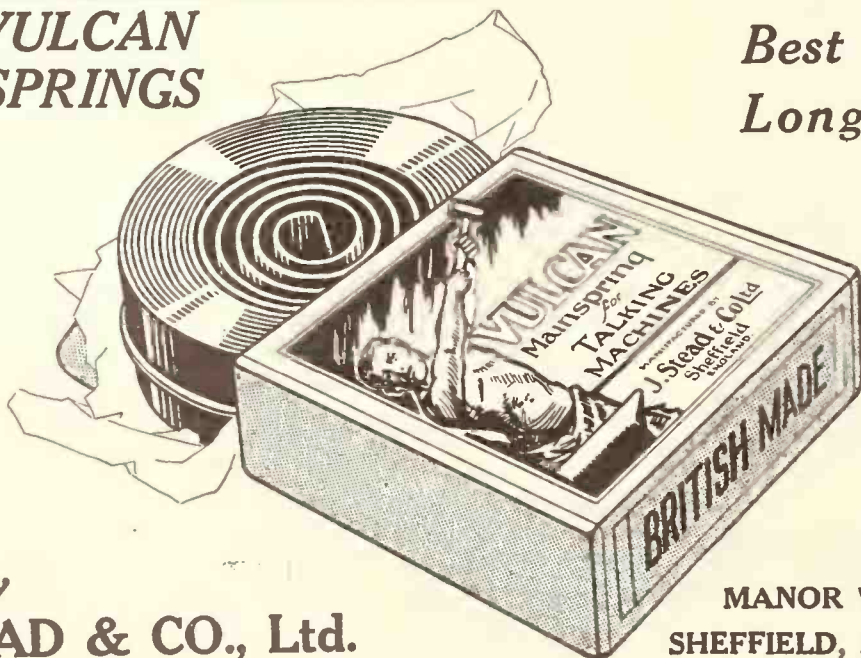

**Best in the
Long Run!**

Note the
Greaseproof
Wrapper.

Made by
J. STEAD & CO., Ltd.

**MANOR WORKS
SHEFFIELD, ENGLAND**



 The Crosley Musicone, announced little more than a year ago, introduced a revolutionary speaker principle and took the radio loud speaker market by storm.

Its overwhelming popularity, which has involved the replacement of hundreds of

thousands of old type loud speakers, establishes beyond challenge the Musicone's superiority.

And now Powel Crosley, Jr., announces . . . the Crosley *Super* Musicone!

This larger 16-inch cone utilizes the same Crosley patented actuating unit as the

smaller Musicone . . . and this, *not* the cone shape, is the secret of Musicone excellence.

It offers, by virtue of its larger proportions, still more superb volume. It produces, especially in the bass, still richer resonance!

The 12-inch Musicone has been reduced to \$12.50. Also at \$32 in the form of a beautiful Console, in which both receiver and batteries may be placed.

THE CROSLY RADIO CORPORATION, CINCINNATI, OHIO . . . POWEL CROSLY, JR., PRESIDENT

CROSLY *Super* MUSICONE

BETTER •  COSTS LESS

Write Dept 26 for illustrated booklet

All prices slightly higher West of the Rockies

Special Victor Orthophonic Built for Customs Attache in Interior of China

A Fine Illustration of How American Concerns Go to Great Lengths to Meet Exacting Requirements of People in Far Countries—Instrument Constructed to Cross Desert on Camel

Whatever else may accompany the white man on his penetrations into the far places, music, in some form, is almost invariably included as an essential. That is one of the reasons why American manufacturers of talking machines



Special Orthophonic for China

have always found in foreign countries an excellent and steady market for portable models.

Occasionally, however, a manufacturer is confronted with the problem of meeting an unusual request from a pioneer or traveler who desires something that is not in the catalog. A recent instance, in which an American manufacturer went to unusual lengths to comply with such a request, is evidence of the anxiety of exporters to give the maximum of service in foreign fields.

F. R. MacKendrick, attached to the Chinese Customs Service and stationed in Mengtsh District, Hokow, Yunnan Province, wrote the Victor Talking Machine Co., Camden, N. J., at some length, expressing his desire for an Orthophonic Victrola. Unfortunately, standard models of the coveted instrument were both too heavy and too large for shipment by South China camel train.

Mr. MacKendrick got his machine—a special model designed and built for him to a specific

size and weight, to meet requirements which were set forth succinctly in his letter as follows:

"I have been following with interest your advertisements of the new Orthophonic Victrola in the Saturday Evening Post and would like to purchase one," he wrote. "What I want to know is whether you can or will undertake to make me an Orthophonic in as compact a form as possible to get all of the essential parts in and the volume out of it. In other words, a portable in the sense that it can be packed in a small, strong, felt-lined case—allowing no space in the machine itself for records and to weigh not over 40 kilos (90 pounds), as the caravans will not carry a case over that weight.

"If you will look this place up in an atlas you will see that we are right on the most southern borders of China—the borders of Tonkin, Loas, the Shan States and Burmah, which makes it necessary for us to do a lot of shifting about, and it is essential that we have as good stuff as possible in a very compact form. My old Victrola is a good one, but if the Orthophonic is better and I can get one in a shape that can be carried on caravan travel, I want one.

"As I have been told by your Eastern agent 'no got,' and this is more in the sense of a special order, I do not think you will refuse to deviate from your usual rule of not selling direct and take the matter under consideration."

A camel's capacity load is 180 pounds, evenly balanced as to weight on each side—hence the ninety-pound maximum weight requirement. The size of the desired instrument was no problem, but that of weight was something to be reckoned with. The only way out was a specially designed and constructed instrument.

Now, in building an Orthophonic instrument, the tone chamber has to conform to certain fixed requirements of size and design. An appreciable amount of weight is represented by the winding sound passage, which has a large wooden "heart." The Victor Co. found that this "heart" could be built of balsa wood, the lightest known workable wood. A laminated,

mahogany-veneered case, of usual strength, but with a minimum weight, was constructed to contain the tone chamber, motor and turntable. A standard motor was used, with automatic eccentric groove stop, and all other mechanical and acoustical features of the standard Orthophonic instrument were built into the case. The completed instrument weighed only forty-seven pounds, and its sturdy laminated wood packing case an additional thirty-six pounds, making the total camel weight eighty-three pounds. The camel pack case was enclosed for overseas shipment in an additional export case, which brought the total shipping weight to 141 pounds.

The instrument, which has the same tone quality as its companion machine in the regular Victor line, is twenty inches high, eighteen and one-half inches wide and seventeen inches deep. The tone chamber opening is enclosed with silk screen and ornamental wood grille, and the instrument compares in appearance with the finest pieces of home furniture.

Noted Family of Indians Interested in Mohawk Radio

A family of full-blooded Indians was a feature at the recent Buffalo, N. Y., radio exposition in the exhibit of the Cycle & Auto Supply Co., a distributor. Mohawk one-dial receiving sets, manufactured by the Mohawk Corp. of



Indians Like the Mohawk

Illinois, Chicago, were shown in the display, as can be seen in the accompanying photograph, and the Indian family, consisting of the chief, his squaw and a papoose, grouped in front of their tepee, served to furnish the desired atmosphere for the display. The setting was arranged by Edward J. Bihl, of the Cycle & Auto Supply Co., who is standing at the rear of the exhibit with R. W. Griswold on his right.

Deca-Disc Phonograph Co. for Vigorous Sales Policy

WAYNESBORO, PA., December 4.—At a special meeting of the stockholders of the Deca-Disc Phonograph Co., held in this city on Tuesday, the reorganization plan proposed by the officers of the company was submitted and unanimously approved. It is planned to pursue a vigorous policy in regard to the marketing of the latest designs of phonograph mechanism made by this company, which will play a program of ten records, either ten-inch or twelve-inch. There have been many other refinements added to the designs of the instrument and the general sentiment on the part of the stockholders was for a vigorous effort to bring the merits of this product to the attention of the industry at large.

Striking Victor Record Ads

The fourth of the series of column newspaper advertisements featuring the latest Orthophonic Victor records recently appeared in the newspapers throughout the country and stimulated sales of the recordings listed. These advertisements have won the enthusiastic praise of dealers. The Victor Co. supplied dealers who desired to tie up with three different ready-made advertisements, and two attractive window posters were also sent to the trade.



A-B-Relay

There is some fine profit for dealers in the Jewell A-B-Relay.

Every owner of a modern B-Eliminator and trickle charger equipped radio set is a candidate for a sale.

It switches the B-Eliminator and trickle charger automatically. When the filament is turned on it disconnects the charger and connects the B-Eliminator to the light circuit. Turning the filaments off, reverses the operation. It is very convenient.

Dealers who display and push this item will be pleased with the results.

Send for Form No. 1023, and ask for our discounts.

Jewell Electrical Instrument Co.
1650 WALNUT STREET
CHICAGO, ILL.

"26 Years Making Good Instruments"



A-B-Relay — A quality product. Rugged, positive action, long life. It will not interfere with the normal operation of any set to which it is adapted.



The men behind Neutrodyne

Engineers, physicists, mathematicians, who have placed Neutrodyne in its present position of leadership—and who will keep it there

IN SPITE of the fact that the Neutrodyne receiver of today represents the highest attainments in radio development, no expense is being spared, in the continuance of a policy of constant improvement.

At considerable expense the Hazeltine Corporation and the fourteen companies licensed to manufacture Neutrodyne apparatus maintain a large staff of technical men who devote their entire time to research and experiment in radio. These men, whose names are listed below, are the men who have brought Neutrodyne to the position of leadership it enjoys today. And these are the men whose ideas, designs and inventions will keep Neutrodyne in the forefront in the years to come.

These men are determined that Neutrodyne receivers will always combine the best in sensitivity, selectivity, ease and economy of operation, volume and perfection of tone reproduction.

PROFESSOR L. A. HAZELTINE: M.E. Fellow A.I.E.E. Fellow I.R.E. Fellow American Physical Society. Formerly professor in charge of the Electrical Engineering Department of Stevens Institute of Technology. Inventor of the Neutrodyne Radio Receiver.

R. W. ACKERMAN: C. E. Schools of Mines, Engineering and Chemistry, Columbia University. Active service U. S. Army Engineers, 82nd Division.

LEWIS M. CLEMENT: B.S. in E.E. F.I.R.E. Assistant Chief Engineer of high-power Marconi stations in Honolulu and San Francisco during construction and early operation. Nine years with Bell Telephone Laboratories in charge of radio receiver and special developments, including government transmitter, receivers, secret systems, etc.

J. W. FINK: M.E. Specialist in audio frequency and loud speaker development.

DONALD O. FRIEND: Massachusetts Institute of Technology.

S. W. GILFILLAN: Stanford University.

VIRGIL M. GRAHAM: I.R.E. A.I.E.E. University of Rochester.

LELAND H. HANSEN: I.R.E. Designer of radio apparatus since 1916. Formerly with American Marconi Company, 1911-1925. Active service U. S. Signal Corps in France.

FRANK A. HINNERS: F.I.R.E. Pratt Institute. Associated with radio development in all its phases since 1909. Among earliest workers on quenched spark telegraphy in this country. In charge transmitter design supplied U. S. Government during war. Chief Engineer extensive overland radio telegraph system.

F. E. JOHNSTON: A.I.E.E. Long Beach, Cal., Polytechnic and Sorbonne and Ecole Supérieur de Electricité, Paris; First Lieut. Radio Intelligence Section U. S. Signal Corps. Croix de Guerre and U. S. Citation. Assistant Engineer in charge construction of high-power station at Warsaw, Poland. Engineer in charge of Riverhead, L. I., Transatlantic Radio Station.

C. T. JOHNSTON: E.E. University of Iowa.

THOMAS S. LEOSER: I.R.E. Lehigh University.

W. W. LINDSAY, JR.: I.R.E. Technical School, Hanover, Germany. Post-graduate work, Columbia University.

R. E. MACDOWELL: B.S. in M.E. and E.E.E. Electrical experimental work, Radio Telephone Officers' School, U. S. Government.

R. MACGREGOR: E.E. Provinside Acad. of Electrics, Glasgow, Scotland. Exp. work in British Navy, two years.

W. A. MACDONALD: I.R.E. University of Paris. Lieut. Sig. Corps U. S. Army in France. Engineer in charge development of airplane radio transmitter equipment Signal Corps U. S. Army (four years). Consulting Engineering Dept., Radio Corporation of America.

RAY H. MANSON: E.E. I.R.E. A.I.E.E. Member S.A.E. University of Maine. Chairman Technical Committee. Radio Sect., N.E.M.A. Committee on Communication. Chairman

Electro-Acoustical Sub-Committee of I.R.E. Standardization Com. Member Bur. of Standards, Radio Advisory Committee. Member Component Part Committee of Tech. Sub-Committee, A.E.S.C. Sect., Committee on Radio.

BENJAMIN F. MIESSNER: I.R.E. Member American Soc. to Advance Science. Purdue University. Authority on electrical acoustics. Engaged in radio research since 1908.

JOHN W. MILLION, JR.: A.B. University of Michigan. Instructor, Mathematics and Physics, Des Moines University. Graduate in research, Washington University, St. Louis, Mo. Graduate work, Columbia University. Development work in vacuum tubes and radio reception in Bell Telephone Laboratories, July, 1923, to Jan. 1, 1925.

WILLIAM J. MURDOCK: Designer and manufacturer of radio apparatus since 1904.

J. N. NICHOLS: B.S. in E.E. First Imperial Light Science School, Petrograd, Russia. Engineer Instructor, Russian Imperial Army, and later French Air Service.

J. A. NEILSON: Copenhagen Technical School, Denmark. Research work in Danish Naval Radio Service.

BENJAMIN OLNEY: Electro-Acoustical Engineer. Specially engaged in audio frequency amplification and speech reproduction research.

LAWRENCE S. PHILBRICK: Phillips Andover Academy, Massachusetts Institute of Technology.

F. F. PRELAG: B.S. Vienna, Austria. Engaged in experimental research work in radio in Europe and this country.

R. X. RETTENMEYER: M.S. B.S. in E.E. Formerly in the Bell Telephone Laboratories in charge of work on high quality carrier broadcast systems.

A. W. SAUNDERS: E.E. Formerly in Bell Telephone Laboratories in radio receiver development design, including receivers used by U. S. Coast Guard.

ROGER W. SEMONS: R.E. Assistant Instructor, Harvard Radio School, 1917-22. Design Eng. of broadcast stations.

F. J. STRASSNER: B.S. in E.E. and E.E. Formerly with Bell Telephone Laboratories. Engaged in transmission maintenance matters. District plant engineer for New York Telephone Company for eight years.

HOWARD J. TYZZER: I.R.E. Designer of radio receiving apparatus since 1916.

LINCOLN G. WALSH: M.E. A.S.M.E. A.I.E.E. Stevens Institute of Technology. Research work in Bell Telephone Laboratories. Chairman, Metropolitan Section, Intercollegiate Convention, A.S.M.E.

HAROLD A. WHEELER: B.S. in Physics, George Washington University. Graduate work in Physics, Johns Hopkins University. Engaged in special research work with Neutrodyne apparatus since 1922.

S. TRUBEE WOODHULL: B.E.E. University of Michigan. Formerly with the American Marconi Company. Designed transmitting apparatus for United States Navy and special apparatus for operation in the trenches during the war.

Look for this trade-mark

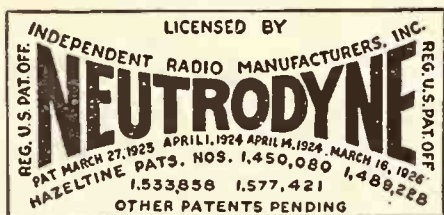

It is your protection against patent infringement liability

The following fourteen manufacturers are the only ones licensed to make Neutrodyne receivers and the protection of distributors and dealers against patent infringement liability, maintained by the Hazeltine Corporation and Independent Radio Manufacturers, Incorporated, applies to none other than Neutrodyne receivers.

- THE AMRAD CORPORATION
Medford, Hillside, Mass.
- F. A. D. ANDREA, Inc.
New York City
- CARLOYD ELECTRIC & RADIO COMPANY
Newark, N. J.
- EAGLE RADIO COMPANY
Newark, N. J.
- FREED-EISEMANN RADIO CORPORATION
Brooklyn, N. Y.

HAZELTINE CORPORATION

(Sole owner of "Neutrodyne" patents and trade-marks)

- GAROD CORPORATION
Belleville, N. J.
- GILFILLAN RADIO CORPORATION
Los Angeles, Cal.
- HOWARD RADIO COMPANY, Inc.
Chicago, Ill.
- KING-HINNERS RADIO COMPANY, Inc.
Buffalo, N. Y.
- WM. J. MURDOCK Co.
Chelsea, Mass.

INDEPENDENT RADIO MANUFACTURERS, INCORPORATED

(Exclusive licensee of Hazeltine Corporation)

- STROMBERG-CARLSON TELEPHONE MANUFACTURING COMPANY
Rochester, N. Y.
- R. E. THOMPSON MANUFACTURING CO.
Jersey City, N. J.
- WARE RADIO CORPORATION
New York City
- THE WORK-RITE MANUFACTURING CO.
Cleveland, Ohio

Mass Production

methods and tremendous purchasing power brought to Amrad and applied to building Neutrodyne a year ago by Powel Crosley Jr. make available to the public a 5 tube Neutrodyne at \$60.

In this 5-tube battery type Neutrodyne at \$60 great engineering skill is manifest in the splendid performance of the set. Cabinet and trimmings are all any purchaser could ask—beautifully finished and appointed. Recessed dials behind windows and delicately adjusted vernier controls are distinctive features



Model S-522



Cone Table for table models S-522 and AC-5 with Crosley Musicone Built in. Ample room for batteries or power unit. \$32

—and a light socket operated Neutrodyne at \$150

This is Amrad's crowning achievement. A power unit, using a current direct from your light socket on wall or from table lamp furnishes A, B and C current direct to the 5-tube Neutrodyne pictured at the right. This power unit is pictured directly behind the set.

No batteries—nothing to charge. An entirely new development in power supply. Amazing Mershon Condensers contribute to its great efficiency and compactness. TESTED BY CONSTANT USE IN HOMES FOR OVER A YEAR. Price of receiver \$65. Price of power unit separately \$85.



Model AC-5

Model AC-5-C

Add a Mershon Condenser to your B eliminator for super-B current supply

30 MFD DUOTYPE



Filtering out light socket current hum is but part of the job. Eliminators must have STORAGE capacity to prevent "chopping off" of loud or sustained notes. The Mershon Condenser acts as a reservoir and STORES energy for sudden heavy drains on plate current. Does the work of expensive storage battery electrically rather than chemically. B eliminator connected with this condenser gives the excellent tone reproduction of fresh B batteries.

Mershon Electric Condenser 15 mfd capacity each half. 30 mfd total capacity. Type D-15-30. Maximum rating 300 volts D. C. If punctured can be repaired and need not be thrown away.

\$8

AMRAD

AMRAD CORPORATION

Medford Hillside, Mass.

HAROLD J. POWER, Pres.

Write Dept. 7L6 for descriptive literature

NEUTRODYNES

Light Socket Operated 5 Tube Console

A beautiful cabinet in two-tone finished mahogany. Stands 40 inches high. Genuine Crosley Musicone built-in. Equipped with 5 tube battery type set \$110—with lamp socket set and power unit \$200.



Everywhere the demand is increasing!
FADA HARMONATED RECEPTION
 has made Radio history

FOR years Fada Radio Engineers worked on this problem of improved radio reception and reproduction. They had a definite aim. To satisfy the demands of the more exacting radio public. They christened their achievement "Fada Harmonated Reception."

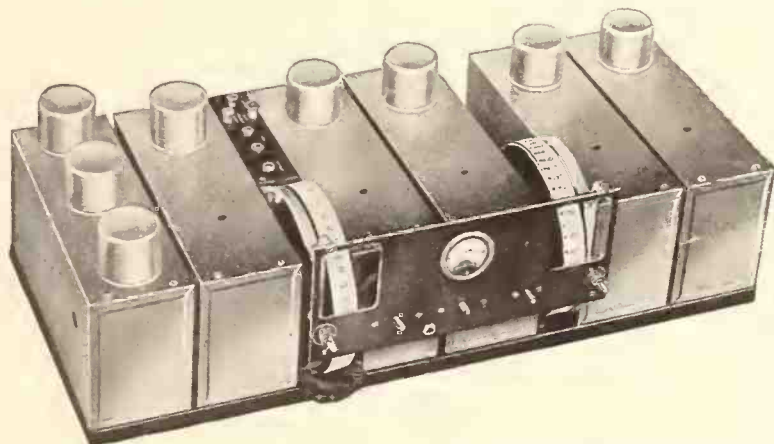

The steel covering of the chassis completely and individually protects each and every "stage". It eliminates interference. The weak signal is brought up to sturdiness at the cone speaker.

THE Fada Cone Speaker has made possible absolute co-ordination between receiver and speaker. Every sound is reproduced with a clearness and accuracy hitherto undreamed of.

Fada Harmonated Reception is beyond a doubt the supreme radio achievement of the year. The immediate nation-wide response proves the fact.

To Dealers: If you are looking beyond the immediate—to an established position in the Radio field—if you are anxious to capitalize on the permanent public demand for Fada Harmonated Reception, write or wire us at once.

F. A. D. ANDREA, INC.
 1581 Jerome Avenue New York

Manufacturers of TUNED RADIO FREQUENCY RECEIVERS using the highly efficient NEUTRODYNE principle.

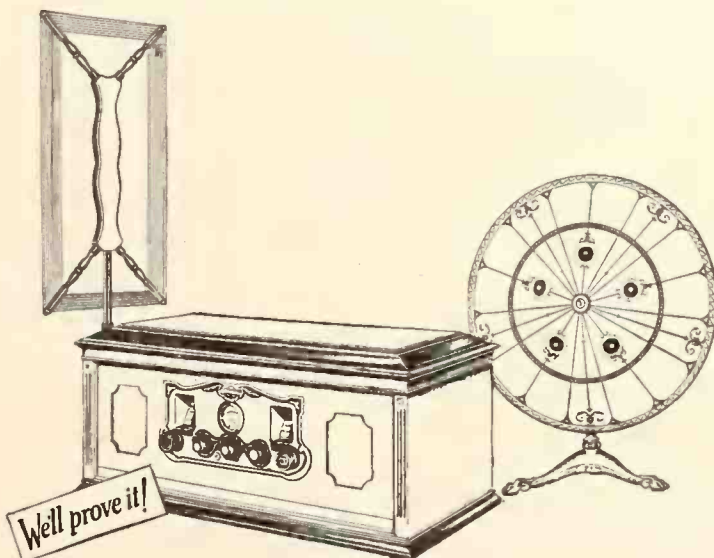

Fada 8, Table Type—loop operated—loop nests in cabinet cover. Total individual shielding. Four stages of radio frequency — \$300. Fada Cone Speaker, Table Type—\$35.

Fada Neutrodyne Receivers—table and furniture models—5, 6 and 8 tubes—ranging from \$85 to \$400. Fada Cone Speaker, Table Type, \$35—Pedestal Floor Type, \$50.



FAMOUS

Emerson Records

ELECTRICALLY RECORDED

8 WEST 32nd ST., NEW YORK CITY



Vladimir Shavitch Praises the Columbia Viva-tonal

Conductor of the Syracuse Symphony Orchestra
Pays High Tribute to Viva-tonal Phonograph
and New Recording Method

The Columbia Phonograph Co., New York,
has received many expressions of endorsement
of the Viva-tonal line of Columbia phono-



Vladimir Shavitch and Viva-tonal
graphs from personages high in the music
world and the receipt of such tributes is
naturally a source of gratification to the of-
ficials of the company. The following letter
was recently received by E. W. Guttenberger,
manager of the wholesale division of the com-
pany, from Vladimir Shavitch, conductor of the
Syracuse Symphony Orchestra and formerly
conductor of the London Symphony Orches-
tra. It reads:

"I take pleasure in adding my endorsement
to your really remarkable new instrument, the
Viva-tonal Columbia.

"The performance of this instrument is very
satisfying, the balance between treble and bass
being maintained to an exceptional degree.

"Listening to your London Symphony Or-
chestra records I was especially impressed by
the merit of your new method of recording."

The accompanying photograph shows Mr.
Shavitch standing by the Viva-tonal phono-
graph he recently purchased from the Clark
Music Co., Syracuse, N. Y.

Sonochorde Cone Loud Speaker Is Improved

CHELSEA, MASS., December 6.—The Boudette
Mfg. Co., of this city, maker of the Sonochorde
cone loud speaker, has announced that it is now

using a new unit in its cone which will take
greatly increased power. The distinctive appear-
ance of the Sonochorde cone is not changed in
the least, the only change being in the unit it-
self. The new unit is produced to take care of
the increased power used in the newer radio
sets. Laboratory tests have proved that the
new unit will take a voltage far in excess of
that required by any of the standard radio sets
and will at the same time reproduce equally
well with the lesser-powered sets. The Boudette
Mfg. Co. makes its own unit.

Puccini Utilized Records of Chinese Music in "Turandot"

The phonograph plays a rather paradoxically
silent, though important part in Puccini's last
opera, "Turandot" which was presented with
such tremendous success at the Metropolitan
Opera House, New York, recently. Some time
before his death in 1924, Giacomo Puccini, in
a letter to Gatti-Cassazza, asked that records
of any Chinese music which might be obtain-
able in this country be forwarded to him in
Italy.

After an exhaustive and careful search Gatti-
Cassazza was successful in securing records
which he thought would be of value and
despatched several of them to Italy. From this
material Puccini fashioned part of the inci-
dental music to his score and is believed to
have made other adaptations from the discs in
the opera's recitatives and arias.

It is interesting in this connection to note
that Respighi in his "Pines of Rome" suite
incorporated the playing of a phonograph record
of a nightingale's song, which was referred to
in The Talking Machine World at the time it
was introduced in New York.

Store Door Radio Playing Not Detrimental to Health

Charges brought against two radio dealers
situated in lower New York, stating that by
playing instruments in front of their stores they
worked a detriment to health and were nerve-
racking, were dismissed by Magistrate C. W.
Simpson, who listened to a five-minute demon-
stration in court of the radio receiver in ques-
tion. The magistrate, who stated that he quali-
fied as a musician and was acquainted with
those things which go toward proficiency in
music, said: "I believe that the sounds I have
heard from this radio set are harmonious. They
certainly do not endanger life nor are they det-
rimental to health. This defendant is engaged
in business to earn a livelihood. He is located
in a noisy street and no act of his has been
proved in this court to show me that he has
done anything dangerous to the life or health
of the community. I herewith discharge him."

Udell Line of Cabinets Has Wide and Varied Range

This Season's Models Include, in Addition to
Mahogany and Walnut Finishes, Various
Colors of Enamel Finishes—New Catalog

INDIANAPOLIS, IND., December 4.—One of the
outstanding features of the Udell line of radio
and music roll cabinets, manufactured by the

Udell Works of this
city, aside from the
high quality of the
product, is the wide
range of sizes,
finishes, designs and
prices which are in-
cluded in the com-
plete line. This sea-
son's new models
include not only the
popular mahogany
and walnut finishes,
but also various colors
of enamel finishes in
hand-painted effects.

Officials of the Udell organization antici-
pated the heavy demand for quality cabinets
that is being felt this season and to the end
of being in a position to fill this demand, built



Udell Console

and walnut finishes, but also various colors
of enamel finishes in hand-painted effects.

Officials of the Udell organization antici-
pated the heavy demand for quality cabinets
that is being felt this season and to the end
of being in a position to fill this demand, built



Udell Highboy Cabinets

up a large stock of cabinets during the Sum-
mer months and have the factory working
overtime at present so that the company is in
splendid shape to fill orders promptly for the
Udell dealers throughout the United States.

In order that dealers can be in a position
to take care of the coming holiday trade, the
Udell Works recently issued a new catalog,
No. 85, giving a complete description of the
full Udell line with profuse illustrations.

Distributor Adds to Line

E. M. Wilson & Son, 11 Lafayette street,
Newark, N. J., one of the best-known Eastern
radio distributors, who have featured the Garod
line of receivers, were recently appointed by the
National Lamp Works of the General Electric
Co. as distributors of the "Banner Brand Na-
tional Mazda" lamps.

Rohr's Music Shop, of Forest Park, Ill., has
added the Radiola and Atwater Kent lines.

Toledo Radio Show a Marked Success— Leading Lines Viewed by Crowds Daily

Wednesday Evenings at Greene Co.'s Store Devoted to Panatrope School for Salesmen—Insistent Demand for Standard Products on the Part of the Public Eliminates "Gyp" Competition

TOLEDO, O., December 8.—The trend of holiday buying has made this a season of better phonographs, radios and combinations. The "gyp" dealer hasn't a chance here this year. In fact merchants, because of the insistent demand for standard products, could not afford to consider any but well-known merchandise. Sales of combinations ranging from \$500 to \$1,200 are numerous. And the average for phonographs has risen from \$150 to \$350.

The Toledo Radio Show, which closed on December 4, was such a pronounced success that a much larger and more elaborate exhibition is already planned for next year. G. B. Bodenhoff directed the show. National radio stars contributed largely to the success of the exposition. There were thirty-six exhibits.

Monday night, which was opening night, was also J. W. Greene Co. night. The concern furnished the music and provided the entertainment for the evening. It also has one of the most prominent and elaborate displays at the show. Radio sales at the store are 50 per cent greater and phonograph sales 20 per cent larger than last year.

Ed. Hartman, service man of the J. W. Greene Co., is at the Sparton factory studying service methods.

In connection with the Panatrope school for salesmen, which has a session every Wednesday evening in the Greene Co.'s store, Mr. Zatorski, of the Brunswick Co., Chicago, addressed the group recently. He stopped here on his way East where he will embark for South America. Here Christmas orders embrace several Brunswick combinations of the \$1,100 type and a number of \$650 and \$1,000 Orthophonics.

H. Hysteh has joined forces with the J. W.

Greene Co., and Miss Helen Fogel is now in charge of the advertising department.

The Lion Store Music Rooms are selling a large number of records through a booth setting close to the elevators. Under the general title, "Hits of the Season," a dozen or more discs are named in high colors on individual circular cards. Manager Lawson S. Talbert reported that it is remarkable how people respond to suggestions of this nature. It is planned to change the display as new hits are brought out. Thirteen girls are now engaged here in serving record buyers. In order to keep record sales from becoming top heavy a premium is paid each day to the girl having the greatest unit sales and for the largest number of sales embracing one or more better records. Every day the assortment of good music is changed. The suggestion—a package of records makes an excellent Christmas gift—is hung in demonstration booths and at the service counter. Gladys Snyder is a new member of the staff.

The Goosman Piano Co. has opened a radio department which is in charge of Arthur McPhillips. The Grebe line is the principal assortment of sets dealt in. Columbia Vivatone models are difficult to get in full assortments, Fred N. Goosman stated. Several industrial companies are placing the machines in their welfare departments. G. V. Leonard is a new member of the sales staff.

The Whitney-Blaine-Wildermuth Co. has moved into its fine new home at Adams & Erie streets, where it now has double the former floor space. The main floor is devoted to records, phonographs and small goods. The second floor is given over to pianos. The third

floor has the radio department. Mohawk and A. C. Dayton outfits are new items of radio products. These, with Zenith and Atwater Kent, round out the line.

Grinnell Bros. coupled their efforts to the radio show, giving prominence to Garod, Atwater Kent, Freed-Eisemann and Zenith outfits. Also the Kellogg radio line was added recently.

O. V. Schaeffer has been made manager of the phonograph and radio departments of the J. W. Rowlands Co., Lima, O. He was, for some time, with the Lion Store Victor section. Victor and Brunswick machines, Atwater Kent and Thompson radios are dealt in by the house.

Speaker in Growing Demand

BETZWOOD, PA., December 6.—The Music Master Corp., of this city, under the capable management of David S. Ludlum, trustee, reports good business this Fall on the Music Master loud speaker. Mr. Ludlum believed that there was a good market for this product and accordingly he featured it. Advertisements were addressed to the trade and general public and the result was the recreation of a decided demand for the Music Master horn.

Markets "A" Autopower

SWISSVALE, PA., December 6.—The Westinghouse Union Battery Co., of this city, has recently placed upon the market its newest product, known as the "A" autopower. It is produced in four models, both 4 and 6 volt, and 25 and 60 cycle. The unit consists of a special design rubber-cased storage battery to which is permanently attached a trickle charge rectifier. When plugged into the light socket it is ready for operation.

The Harmony Talking Machine Shop, Inc., Brooklyn, N. Y., has made an assignment to Max Klein, New York.

*The institution behind
the TRADE MARK!*

MASTERCRAFT
"ALL THAT THE NAME IMPLIES"

THE MASTERCRAFT trademark on a Phonograph or Radio Console stands for the highest possible quality. Every Wolf product is virtually a masterpiece of skilled master craftsmen. That's why the MASTERCRAFT trademark assures a quality product through and through.

PLANT N^o1

PLANT N^o2

OFFICES
IN—
NEW YORK
BOSTON
CHICAGO
NEW ORLEANS

The WOLF MANUFACTURING INDUSTRIES - Quincy Ill.

The New Reproducing
Sonora
CLEAR AS A BELL 

The tremendous success of the new reproducing phonograph is due in a large measure to the desire created by the radio for more good dance music. The before Christmas



purchaser of radio will be the "after holiday" buyer of phonographs. Plan on phonograph efforts and profits now for a well balanced business.



The outstanding value in the field of reproducing phonographs — The Prelude
\$95

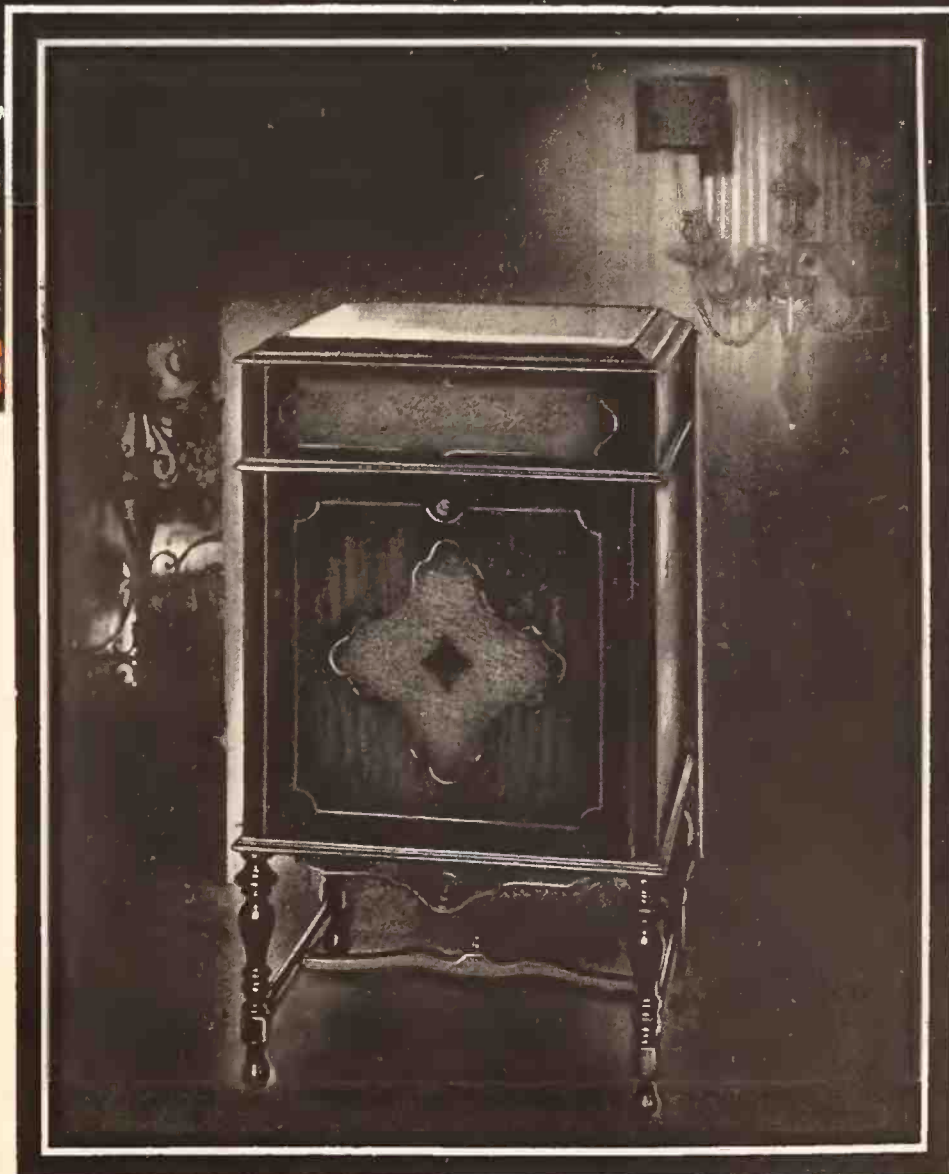

Kansas City Distributors Kept on the Jump to Keep Dealers Stocked With Models

High Priced Instruments Have the Call, Report Dealers, and Make Up for Lack of Unit Sales—Entire Trade Carrying on Drives to Make This a Profitable Business Season

KANSAS CITY, Mo., December 7.—With the approach of the holiday season activity in talking machines throughout the retail trade in Kansas City is showing a decided impetus. It has been a peculiar feature of the Fall buying in talking machine lines that, although volume has not been equal to expectations, yet high-priced machines have sold without difficulty.

With the year 1926 almost ended, the dealers are looking back over the year as a whole and are agreed that this has been an unusually good year, with sales from 15 to 50 per cent ahead of last year. All are optimistic about the prospects for the phonograph business during 1927.

The distributors are only worried about getting enough machines to keep their dealers reasonably supplied, and all are finding orders and reorders coming in faster than they can fill them. Sales of records have been uniformly good throughout the city.

Miss J. M. Poynter, head of the Jones Store phonograph department, reports that they are making plans for the biggest Christmas season in many years. Miss Poynter says that they have been more than pleased with the reception accorded to the new Edison, which they have had in stock for several weeks now. The public interest in this new product of the Edison company is resulting in a good volume of sales, and the new records also are moving briskly. The new Sonora is now in stock at Jones', the only dealer in town carrying this line, and Miss Poynter says that it is finding approval with the public also.

W. R. MacDonald, manager of the Edison Phonograph Distributing Co. here, reports that the new Edison models have met with enthusiastic response in all parts of the territory and that orders are keeping them overwhelmed. Having waited for the phonographs and expected much of them, the dealers are reporting the instruments far better even than their expectations had pictured them.

T. H. Condon, manager of the phonograph department of the local branch of the Brunswick Co. here, has returned from a trip through part of the territory and he reports that it has never been in better condition for

immediate sales. The volume of sales for the branch here has been showing a continued increase throughout the Fall, according to Mr. Condon, and now with Christmas almost here there has been a decided increase in interest.

The P R 148-C model combination Panatrop and Radiola, priced at \$1,200, has been moving exceptionally well, while the P-11 model has been very popular, and all the mechanical models are receiving the greatest favor with the public. Portables are holding up to a steady demand.

Victor Loud Speaker Poster

The Victor Talking Machine Co. has sent to its dealers an attractive window display poster featuring the Victor Lumiere loud speaker. The poster is printed in deep, rich colors and shows the loud speaker standing in the center of a mantel over an open fireplace, flanked on each side by candlesticks. The lower part of the poster is given over to a listing of the capabilities of the speaker. It is very effective advertising.

Starr Christmas Literature

RICHMOND, IND., December 8.—The Starr Piano Co. recently sent to its dealers new Christmas literature printed in the vivid colors traditional of Christmas and devoted to illustrations and descriptions of the line of Gennett phonographs, both the regular lines and portables, and Starr pianos.

Installation Instructions

A new handbook has been issued by the Bureau of Standards as part of the national code which contains safety rules regarding radio installations. It contains suggestions for the installation of radio receiving equipment. The handbook is known as No. 9 and may be obtained from the Superintendent of Documents, Government Printing Office, Washington, D. C., for ten cents.

Ray Miller's Brunswick Orchestra has been playing some special engagements in southern Kansas and Oklahoma, and the Brunswick dealers have taken advantage of these appearances to do some special advertising, which has resulted in increased record sales.

The Columbia wholesale office is "snowed under," according to W. B. Ockenden, manager of the local branch. However, they are making deliveries in sufficient quantities to keep the dealers in stock, and expect the Christmas business to be phenomenal. Walter Beckert, mechanical expert from the Columbia Co. at Bridgeport, was in Kansas City for several days about the first of December. Mr. Beckert is returning from a tour of all the company branches throughout the country and finds that business conditions with Columbia dealers are very satisfactory.

RCA Super-Heterodyne Used in Queen's Private Car

Unique Installation Made by Radio Corp. in Private Car of Train Which Carried Roumanian Queen Across the Country

A unique radio installation was made by the Radio Corp. of America in a section of the drawing room in the private car which carried Queen Marie of Roumania and her entourage across the continent. It consisted of a Radiola Super-Heterodyne Model 28 and a Model 100 cone type loud speaker. It is illustrated herewith. Because of the peculiar conditions under



Radiola in Queen Marie's Private Car

which this receiver had to operate, the regular loop antenna was dispensed with and a special antenna running along the top of the car was erected in its place. The receiver was grounded to a nearby radiator. Arrangements were made with RCA distributors to thoroughly inspect and adjust the equipment at every important key city stop.

Galveston Piano Co. Moves

GALVESTON, TEX., December 3.—The Galveston Piano Co. recently celebrated the opening of its new quarters, at 2015 Market street, with a formal reception to the public. The talking machine and small goods sections of the store are conveniently arranged and the stock of instruments has been materially increased.

Boy Scout Band Popular

The Springfield Boy Scout Band, which a short time ago made its first recording for the Brunswick Co., is in vaudeville, playing to packed houses at Loew's State Theatre, Chicago, Ill. The records made by these youthful artists are proving popular.

Stowers Music Co., of Key West, Fla., which handles the Orthophonic Victor line, is doing an excellent business and reports growing sales.

The Toman Reproducer

Retail Prices

Nickel Plated \$7.50

Gold Plated \$10.00

Write for trade discounts.

Sample on approval (5 days) to any responsible dealer.

Will sell itself on quality and volume of tone. We challenge comparison.

Wonderful, deep, rich, mellow and powerful tone.

Surpassed by none.

Send for sample NOW!

Manufactured by

E. Toman & Co.

2621 West 21st Place

CHICAGO, ILL.

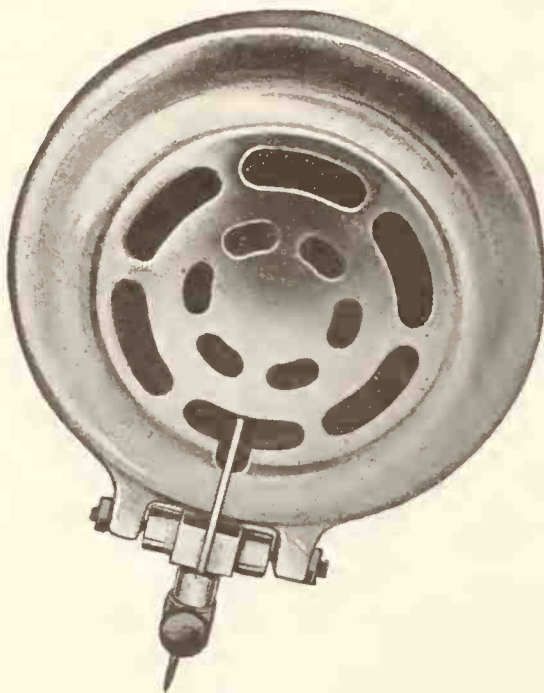

Sales Distributor

Wondertone Phonograph Co.

216 No. Michigan Ave., Chicago, Ill.

Cable Address—"Wondertone Chicago."

Cable Codes—Western Union—A.B.C. (5th Edition).

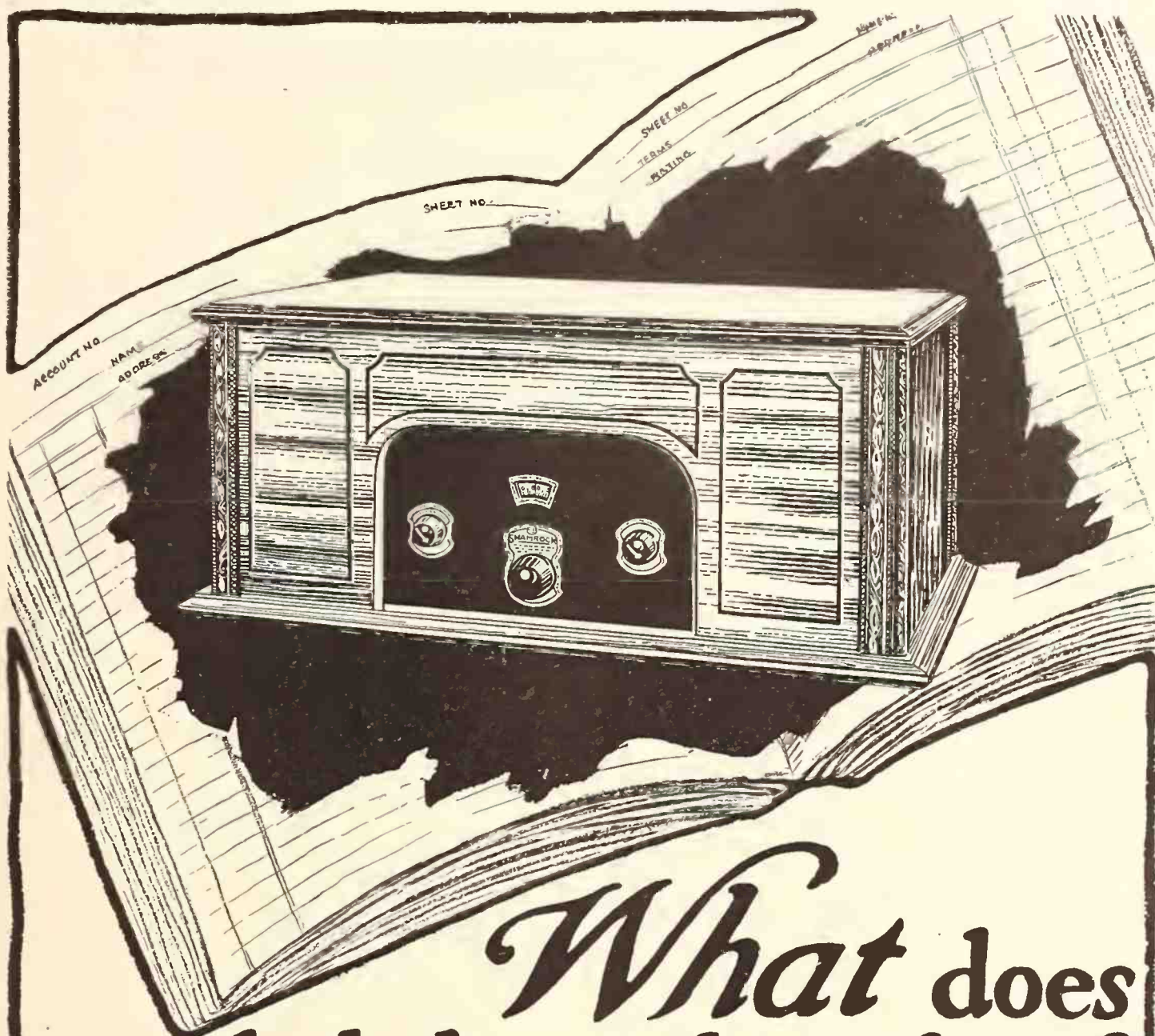

What does the balance-sheet show?

ARE you just getting by, or are you in the red figure class? In either case Shamrock invites your inquiry because most Shamrock Dealers are in the other class—they make money!

They have every reason to. Shamrock is an attractive set that has eye-compelling features. It's selective and sensitive with a perfected one-dial control—has volume and tonal qualities quite out of the ordinary and it's priced reasonably. When it is sold it *stays* sold!

When a set possesses all of those features sales are bound to result—it sells on merit

alone. Coupled with the aggressive Shamrock advertising policy it is only reasonable to expect Dealers to show profits. And they do!

Write in for details if you would like to join the happy throng.

SHAMROCK

RADIO SETS

SHAMROCK RADIO COMPANY

Pioneers in Building Perfected One Dial Sets

196 Waverly Avenue

Newark, N. J.

New Starr Phonographs Excite Wide Interest Among Dealers in Cleveland Field

Four Million Dollars in Christmas Club Savings Released by Banks Expected to Have Marked Effect on Pre-Holiday Sales—Dealers Optimistic—A. G. Kemp in New Post—Other Activities

CLEVELAND, O., December 7.—It is the general consensus of the trade that business will be good for Christmas; the banks released four million dollars in cash to depositors in Christmas Savings Clubs on December 1. Up until that time the demand for the smaller phonographs had been very light, but sales on the expensive models were very good. The release of the above-mentioned money and employment of several thousand men made itself manifest by a decided pick-up in sales.

New Starr Phonographs Arrive

The new line of Starr phonographs was received at the Cleveland branch around the first of the month and created much interest among the dealers. A number of the trade from out of town visited Cleveland for the express purpose of seeing and hearing the new machines and they were well pleased with them. The Cleveland branch remodeled the first floor of its building on Huron Road and now has one of the most attractive display rooms in the entire city.

Doubles Force for Holiday Rush

The Cleveland Talking Machine Co., Victor distributor, doubled its force in the shipping room and order department December 1 in order to take care of the enormous volume of business coming through. The new Victor folder in colors entitled "Xmas time is music time" was used by the majority of dealers in mail campaigns for Christmas business and is reported to have pulled well. While the Victor portable only made its bow to the Cleveland public less than a month ago, its sales have steadily mounted and the trade is confident of a big demand for it over the holidays.

Puts Panatropes in Theatre

The Buescher Music Co., Euclid avenue near East 105th street, supplied two Panatropes for use in Keith's Theatre the week of December 6. Harry Snodgrass, known as "King of the Ivories," used one in his act and the other was used for demonstration purposes in the lobby.

Advertising the Columbia Viva-tonal

Columbia dealers in Cleveland and suburbs have done a great deal of advertising of both the new Viva-tonal machines and Columbia rec-

ords in suburban papers. They also tied up well with the full-page ads run by the Columbia Co. in the large dailies. The Ponce Sisters, Columbia artists, were held over an extra week upon request. Another artist appearing here was Ethel Waters. The trade tied up with their appearance and cashed in well. R. J. Mueller, district manager of the Columbia Co., reports that the holiday business at all branches served from Cleveland gives every indication of being exceptionally good.

Arthur G. Kemp With Brunswick Branch

The Cleveland branch of the Brunswick Co. appointed Arthur G. Kemp representative for the Cleveland section, to take the place of Mr. Hemmingway, resigned. The latter became associated with his father in business in New York.

George Worthington Co. to Celebrate Centennial

The fact that the George Worthington Co., Fada distributor in Cleveland, O., will celebrate its centennial in 1927 was the subject of congratulatory resolutions at a recent Fada radio meeting in that city. It is stated that the Worthington Co. is a \$10,000,000 organization engaged in the distribution of radio, electrical specialties, hardware and ship chandlery. The Fada meeting was attended by a large number of dealers in that territory and was addressed by officials of the George Worthington Co. and R. M. Klein, general manager of F. A. D. Andrea, Inc.

Victrolas for the Kiddies

The Victor Co. is making a drive to sell the portable and small table model Victrolas to children. To this end it has sent its dealers a display poster reading, "The Gift That Keeps on Giving—A Victrola for the kiddies' very own—Keeps the children happy and contented while developing a love for good music. A sturdy little instrument that children can

Both the Panatropes and mechanical models are moving and it is a problem to satisfy the demands of the trade, as instruments are shipped right out as soon as they arrive from the factory. The Vocalion line was taken on by Herman Wodicka during the month and he also added a line of sheet music.

Latest Edison Models in Demand

The Phonograph Co., Edison distributor, has been receiving reorders on the new Edison models. The new twenty-four and forty-minute records are also going over good, manager Herschberger, of the company, reports. The national advertising on this merchandise has helped considerably in pepping up business. The Phonograph Co., which is also distributor of Federal radio receivers, has been unable to keep up with orders. It also sells the Day-Fan line, which is much in demand.

A-K Display Competition a Winner

The Atwater Kent window display contest for dealers of Cleveland and northern Ohio towns can be summed up in two words: very successful. Complete details will appear in the January issue of The World.

operate. Plays all Victor records." A folder illustrating a window display featuring these model Victrolas, together with advertisements devoted to children's models, accompanied the display.

An Interesting Booklet Devoted to Mainsprings

"Points About Springs" is the title of an interesting and admirably written booklet which is being sent the talking machine trade by J. Stead & Co., Ltd., Manor Works, Sheffield, England, manufacturers of Vulcan mainsprings. The scope of this little volume may be gleaned from the character of the subjects discussed under seventeen points, as follows: "Changes of Temperature"; "Temper"; "Testing"; "Full Details"; "Breakage in Stock"; "Perfection"; "Choosing the Correct Spring"; "Edges"; "Motors"; "Again—Temper"; "Length"; "Knocking"; "Our Dealers' List"; "Using the Tested Mainspring"; "Hubs"; "Acids"; "Oils and Greases."

Nothing apparently has been left unsaid that will convey to the dealer, jobber or manufacturer using or handling mainsprings the fullest knowledge of their importance to the perfection of the gramophone or talking machine. The booklet is nicely printed in two colors, well illustrated and enclosed in a striking cover in red. It is a necessary little volume for the use of the dealer because of its information and general scope.

Gimbel Music Dept. Moves

The new ground floor music department of Gimbel Bros. was opened last month at 122 West Thirty-second street, opposite the firm's department store. The new quarters house the music section, which was maintained formerly on the eighth floor of the department store, and a passageway leads from the new section to the store proper under the street level. About 29,000 square feet of space is given over to the music department, M. Max, manager, states. The same lines of talking machines, pianos and other instruments are carried as heretofore.

Comparison Concert in Store

SEATTLE, WASH., December 3.—The Bush & Lane Piano Co. recently arranged a comparison concert in the store, when Jackie Souders and His Orchestra, Columbia artists, played the selections they have recorded for the Columbia catalog and the records were then played on the Viva-tonal phonograph. Sales of records by these artists increased as a result.

Instantaneously—Demonstrate Any Radio Set

With Only One Set of Batteries and Aerial and Ground

Comparative demonstrations are the biggest factor in radio sales today. You must demonstrate to your prospect, but what will clinch a sale is a quick change from the demonstration of one set to the set right next to it. Equip every one of your demonstrators with the Type B. P. Jones MULTI-PLUG Socket, and from your master set of batteries, and ground and aerial, lead your Jones MULTI-PLUG. In just an instant you can hook up completely and correctly any set you want.

Demonstration Means a Sale

Every time you demonstrate a set equipped with the B. P. Jones MULTI-PLUG and make a sale it means a MULTI-PLUG sale to you. It is unavoidable, and a Jones Plug sale means later on no service calls due to wrong connections or blown out tubes.

Equip your demonstrators with the Type B. P. Jones MULTI-PLUG. Write for full information today.

Jones
MULTI-PLUG
THE STANDARD SET CONNECTOR

Trade Mark Registered U. S. Patent Office.

HOWARD B. JONES
618 S. Canal St. Chicago, Ill.

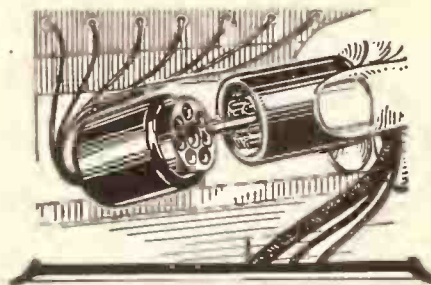

Type B. P.

The socket wires lead from the binding post of any set. The plug wires lead to the A and B batteries and ground and aerial wires. Seven connections in one by the use of one master plug.

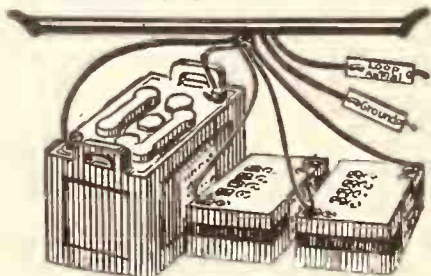

SENSITIVE
as the Ear drum
yet Rugged as Steel!

That's the remarkable fact about *Octacore*—it combines delicacy and strength to an amazing degree.

Listen to it. Note how the highest treble and the lowest base notes flow forth clear as crystal, limpid, pure. Watch for a *fullness* of tone that comes only from reproduction of *all* the overtones.

Then test its strength. Drop it from your extended arm if you will—*Octacore* will not be injured in the least! It will stand the hardest wear and give *satisfaction* to your customers. That means *prestige* to you. The beautiful bronze finish will harmonize well with the furnishings of every home. Investigate *Octacore*—today!



\$ **19⁵⁰**
Slightly higher West of the Rockies

OCTACORE
 PAUSIN

Pausin Engineering Company
 727 Frelinghuysen Avenue Newark, N. J.

Licensed under Frank E. Miller
 Patent numbers—1,190,787
 1,294,137 1,220,669
(Other patents pending)

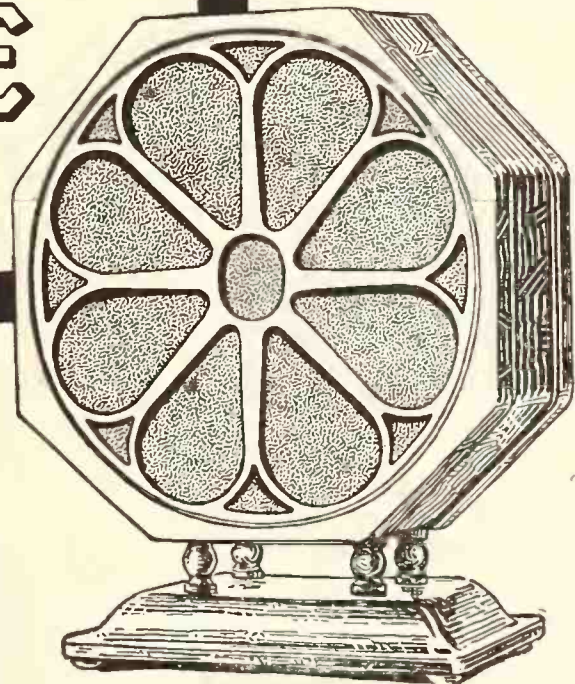

Okeh
and
Odeon
Records

A
Complete List
of

Okeh
IRUEIONE

Distributors

WALTER S. GRAY COMPANY
926 Midway Place, Los Angeles, Calif.

WALTER S. GRAY COMPANY
1054 Mission St., San Francisco, Calif.

PHONOLA CO., LTD., OF CANADA
Elmira, Ont., Canada

JAMES K. POLK, INC.
181 Whitehall St., Atlanta, Ga.

CONSOLIDATED TALKING MA-
CHINE COMPANY
227 W. Washington St., Chicago, Ill.

JUNIUS HART PIANO HOUSE, LTD.
123 Carondelet St., New Orleans, La.

FRANK R. WITMAN PHONOGRAPH
SUPPLY COMPANY
Putnam, Conn.

CONSOLIDATED TALKING MA-
CHINE COMPANY
2957 Gratiot Ave., Detroit, Mich.

CONSOLIDATED TALKING MA-
CHINE COMPANY
1424 Washington Ave. So.,
Minneapolis, Minn.

THE ARTOPHONE CORPORATION
1624 Pine St., St. Louis, Mo.

IROQUOIS SALES CORPORATION
210 Franklin St., Buffalo, N. Y.

OKEH PHONOGRAPH CORP.,
(New York Distributing Division)
15 W. 18th St., New York City

STERLING ROLL AND RECORD
COMPANY
137 W. 4th St., Cincinnati, Ohio

IDEAL PHONO-PARTS CO.
1231 Superior Ave., Cleveland, Ohio

L. D. HEATER
469½ Washington St., Portland, Ore.

EVERYBODY'S TALKING MACHINE
COMPANY
810 Arch St., Philadelphia, Pa.

JAMES K. POLK, INC.
1315 Young St., Dallas, Texas

JAMES K. POLK, INC.
811 West Broad St., Richmond, Va.

Okeh
and
Odeon
Records

Census of Distribution Is Planned by Government

Director of Census W. M. Steuart Declares Such a Survey Is Essential in Analyzing General Conditions in the Music Industry

WASHINGTON, D. C., December 6.—A census of distribution, which would cover sales of musical instruments, similar to the biennial census of manufacturers now carried on, is recommended by Director of the Census W. M. Steuart in his annual report for the fiscal year ended June 30, last, just made public.

It is pointed out by the director that there are probably over 1,000,000 independent enterprises engaged in distribution, many of which distribute their products direct to the consumer. "Under these circumstances," it is declared, "a census of distribution is essential to a proper analysis and understanding of the manufactures data and to a definite knowledge concerning the number and importance of independent enterprises engaged in the two main branches of our industrial and commercial development."

Sacramento Music Trade and Radio Ass'n Meets

How to Get More Business the Broad Subject Discussed at Monthly Meeting—Piano and Radio Men Offer Their Views

SACRAMENTO, CAL., December 4.—At a recent meeting of the Sacramento Music & Radio Trades Association attended by nearly 100 piano, music and radio dealers and department managers, discussion was devoted to the important question of "How to get more business" in all the lines handled by association members.

Ellas Marx, of the Ellas Marx Music Co., president of the association, presided, and among the visitors was Shirley Walker, president of the Northern California Music Trades Association, who made an inspiring address. Other local speakers were Curtis T. Larson, of the Ellas Marx Co.; Henry Wolfe, Sherman, Clay & Co.; J. C. Hobrecht, Cosby Hoops, and several others.

Melvin DeLyons, vice-president of Ernest Ingold, Inc., devoted himself to the question of making radio business profitable and declared that the greatest drawback was in the manner in which dealers handled their service. He held that the free service was unnecessary and uneconomic and served to wipe out any profits that the dealer might realize from his regular sale. 85 per cent of all service calls, he declared, had been proved by careful survey to be the result of carelessness or ignorance on the part of the purchaser for which the dealer was not in any way responsible. If service of this sort was charged for, he declared, the saving to the dealer would be very real.

The evening as a whole proved a most profitable one and following the various talks an interesting entertainment was offered to the members.

Samuel Stephens Plans to Move Music Business

CONSHOHOCKEN, PA., December 8.—Samuel Stephens, who has conducted a music store at the corner of Elm and Fayette streets since 1916, has disposed of the store property at this address and has announced his intention of moving the business to his establishment at 217 West Main street, Norristown. The local music store will be continued until final settlement of the building has been reached. Mr. Stephens leased the property he has been occupying when he first opened the store but bought the building about four years ago.

F. Clifford Estey With Noted Firm of Investment Bankers

Wide Experience in all Branches of Radio Industry Makes His Services Valuable as Merchandising Counsel

F. Clifford Estey, one of the most popular and experienced sales executives in the radio industry, is now associated with a prominent New York firm of investment bankers at 120 Broadway. Mr. Estey is well known through-



F. Clifford Estey

out the radio field and has to his credit many years of successful merchandising experience as a sales and advertising manager for several radio manufacturers. In addition, Mr. Estey is also one of the first radio amateurs, and is a member of the Radio Club of America and the Institute of Radio Engineers. The experience he has had in the industry makes his services as merchandising counsel especially valuable to his associates, who conduct an investment banking business and have varied radio interest. An announcement of interest to the trade will be issued from Mr. Estey's office shortly. Associated with him are Philip Boyer, Harold E. Keays and Ralph A. Clark, the latter being well known in radio engineering circles.

Dealers Add Eckharmonic

PHILADELPHIA, PA., December 8.—The Eckhardt Corp., maker of the Eckharmonic radio receiving set, has found a very receptive market for the new product. Walter L. Eckhardt, president of the corporation, is proceeding in a conservative manner toward building up the distribution of these sets through representative dealers in various localities. Mr. Eckhardt reports that requests for the Eckharmonic line have been received from dealers and distributors in every section of the country and that during the past month approximately thirty representative dealers were appointed. Although Mr. Eckhardt has studiously refrained from claiming remarkable distance with the Eckharmonic and has merchandised it solely upon its individual tone value and appearance, it is interesting to note that in a number of dealers' warerooms the Eckharmonic outdistanced the sets that the dealers already carried, creating interest through performance.

W. F. G. Steele in New Post

W. F. G. Steele has been appointed metropolitan retail sales manager of the Aeolian Co. Mr. Steele has been connected with the Australian branch of the company for twenty-two years and for the past several years has been assistant general sales manager of Aeolian activities in the Antipodes.

Interesting Talks Featured Great Get-Together Meeting Held in Los Angeles

More Than Three Hundred and Fifty Dealers, Salesmen, Wholesalers' and Manufacturers' Representatives and Broadcasters Present—How the Birkel Co. Builds Sales—Other News

LOS ANGELES, CAL., December 6.—Over three hundred and fifty radio dealers, salesmen, jobbers, jobbers' salesmen, manufacturers' agents, manufacturers and broadcasters attended a great get-together meeting at the Elk's Club ballroom in mid-November. Interesting talks were delivered and the entertainment, which was of a very excellent nature, was supplied by Naylor Rogers, manager of KNX, and consisted of the leading stars and entertainers from the station and the Radio Trades Association Concert Orchestra.

Earle C. Anthony spoke earnestly about the wished-for legislation at Washington, declaring that, unless some laws regulating the air are placed on the statute books, radio reception would become chaotic and the industry will be ruined for broadcasters and dealers alike. Guy C. Earl said that his newspaper and others were bending every effort to induce Congress and Senate to pass suitable radio bills. President Hartley also addressed the members on the same subject.

W. G. Bailey, window display manager of the Southern California Music Co., had prepared a special radio display which was on view on one side of the hall and showed dealers how windows in their stores could be dressed.

"Constant publicity stunts and attractive sales ideas are bringing good returns," said George H. Nicholson, manager of the radio and talking machine department of the Birkel Music Co.

During the recent Grand Opera Season in Los Angeles the large display window on Broadway devoted to this department was beautifully decorated as a scene from one of the operas. In this attractive window four half-size wax models of Victor artists held sway, and Victor talking machines and records were handsomely displayed. Records of the opera then playing were constantly played at the door.

Recently the Palace Broadway Theatre closed a five-week showing of *The Volga Boatman*, and movie patrons were surprised to learn that the musical prelude furnished through the courtesy of the Birkel Music Co. was not a large vocal chorus, but in reality a Brunswick Panatrop and four 104 speakers placed advantageously throughout the theatre.

Mention was made in the Screen Trailer that

the Musical Prelude was furnished through the courtesy of the Birkel Music Co., and the program carried an attractive advertisement calling attention to Brunswick Panatropes and records. Machines and records were sold as a direct result of this showing.

The latest business-getter for this wide-awake department consists of a Victor Tuscany placed in the record department. Attached to this by concealed wires is a 104 speaker, which is located at the front door. Conveniently placed at Mr. Nicholson's elbow is a microphone, which is in turn connected with the Tuscany and 104 speaker. At regular intervals the crowd at the front door is told of the new Orthophonic records, the new Orthophonic Victrola and an invitation to hear these records in the record department is extended to all who are listening. The listening crowd is especially attentive when they are advised of the records to be played, and there is an opportunity to call attention to the merchandise displayed in the window. Both record and Orthophonic sales have been benefited by this advertising.

Victor Model Creates Sensation

The new Auditorium model with power amplifier through the Orthophonic horn has created a sensation in Southern California. It was used at the Venice Auditorium, where it was listened to by at least two hundred thousand persons and was also on exhibit at Bullock's Department Store Music Rooms. Sent to San Diego it was again heard at the Balboa Park in that city. It is now in San Francisco and will be used in connection with the San Francisco Symphony Orchestra and will occupy a separate place on the Symphony program, at which time a talk will be given by Philip T. Clay, president of Sherman, Clay & Co.

Brunswick Reports Big Sales

Howard L. Brown, southern California manager of the Brunswick Co., reports extraordinary sales volume in his territory, the demand for the models 148-C and P-11, with the 104 loud speakers, being far beyond anything that could have been anticipated. The local record factory has just finished compiling a catalog of Mexican records for Southern California distribution.

Announcement is made that the Martin Music Co. and Richardson's Inc. will both install full

lines of Brunswicks and Panatropes and Brunswick records.

Trade-Ins Subject of Meeting

At the November general meeting of the Music Trades Association of Southern California, particularly interesting discussions took place in regard to the exchanging of obsolete models as trade-ins toward the payment of the new Electrical Brunswick and Victor instruments and Orthophonic models. A demonstration sale was given during the meeting and an interesting talk was made by George L. Moskovics on the trade-in problem in the automobile industry.

Federal Radio Corp Ready to Meet Holiday Demands

BUFFALO, N. Y., November 10.—The Federal Radio Corp. is bending every effort to fill the volume of advance orders which has been coming in from jobbers throughout the country. It is expected that a sufficient number of Ortho-sonic sets will be available to satisfy the Christ-



Ortho-sonics En Route to New Zealand

mas trade, for double shifts, working day and night at the plant, are endeavoring to practically double the regular output.

Popularity of the Federal Ortho-sonic is spreading not only nationally but internationally. The accompanying photograph illustrates the carload of sets sent recently to New Zealand and which is now somewhere on the high seas. This is the second large shipment to Federal's New Zealand distributors, with further orders already in preparation. According to A. P. Lawrence, export manager of the Federal, New Zealand has shown even greater progress in the adoption of modern conveniences than has been made by most Australian communities.

Ortho-sonic radio will now be distributed in Saskatchewan and Alberta, Canada, by I. J. Haug & Sons, Ltd., of Regina, who were recently added to the list of foreign jobbers.



Phonographs and Radio Cabinets

STYLE 21
Genuine Mahogany or Walnut only.



STYLE 21-B
Same with both top panels hinged to accommodate Radio Panel.



STYLE 17
Genuine Mahogany or Walnut Phonograph only

These illustrations show several of the many late models of our line, which have been redesigned, right up to the minute, with especial reference to the Radio-Phonograph Combination, destined to be the standard household unit.



STYLE 85—RADIO CONSOLE
Accepts Panels Up to 8x26 Inches.



STYLE 1
Gum Mahogany, Golden or Fumed Oak.

Excel Phonograph Manufacturing Company
402-414 West Erie St., Chicago, Illinois



STYLE 2
Gum Mahogany, Golden or Fumed Oak.

These instruments are produced in all the popular finishes and styles, including Uprights, Consoles and Wall Cabinets, and our facilities enable us to make prompt deliveries and most attractive trade prices. *Catalog and price list mailed on request.*

E. H. Schwab Made President of Splitdorf Electrical Co.

Gives Interesting Talk on Policy of the Company—R. W. Porter Is General Sales Manager—Plans Co-operation With Retailers

A policy of intensive development of the radio branch of the business was announced by the Splitdorf Electrical Co. following the November meeting of the board of directors,



E. H. Schwab at His Desk

at which E. H. Schwab was elected president of the company, succeeding M. W. Bartlett, who has retired from the business.

Mr. Schwab has been chairman of the Splitdorf board since 1924 and will continue in that capacity. He was formerly president of the



Robert W. Porter

Bethlehem Spark Plug Co., which united with the Splitdorf interests two years ago, and is a brother of Charles M. Schwab, chairman of the Bethlehem Steel Corp., who is also a member of the Splitdorf board.

Indicating the company's policy for the future, Mr. Schwab made the following statement at the company's offices in Newark, N. J.:

"As one of the oldest electrical concerns in the country, the Splitdorf Electrical Co. was naturally interested in radio from the beginning and has played an active part in its development. In addition to making our own Splitdorf set, we are to-day manufacturing parts

for several other well-known sets. We believe in the future of radio and we intend to share in its further development to an increasing extent.

"Being one of the few companies manufacturing complete sets, from the raw materials to the finished product, we are fortunately placed with respect to radio, because we can control our inventories, maintain uniformity in production and be independent of outside supply of parts. We have the further important advantage that during the off-season our complete experimental, manufacturing and distributing facilities in the radio division can be easily diverted to the home electric and automotive demands of the business. I cannot say more about our plans at the moment, except that we intend to promote the radio end of our business to the fullest extent."

Confirmation of the announcement that radio will take a position of first importance in the affairs of the Splitdorf Co. was forthcoming in the appointment of R. W. Porter, former radio sales manager, as general sales manager. He will direct the sales and advertising of all branches of the business, including radio.

Mr. Porter is widely known as a sales executive in the field of musical instruments for home entertainment and was previously associated with the Columbia Phonograph Co., the R. E. Thompson Manufacturing Co., and at one time with the Winchester Repeating Arms Co. In line with the company's new program of expansion, Mr. Porter will devote much of his time to the co-operative work with retail merchants.

Discuss 1927 Plans of E. T. Cunningham, Inc.

District Sales Managers of Tube Manufacturer Meet at Company's Headquarters in New York City—To Expand Dealer Service.

Aggressive sales and service plans for 1927 were discussed at a recent meeting of district sales managers of E. T. Cunningham, Inc., manufacturer of Cunningham tubes, at the company's headquarters in New York. E. T. Cunningham, president, and Herbert H. Frost, general sales manager, laid before the meeting exhaustive details of the company's merchandising activities during the new year. These include the expansion of dealer service and radio merchandising facilities, and a new engineering service for manufacturers was outlined. An increase in advertising and in the company's sales personnel was decided upon.

The Cunningham district managers present at the meeting included M. F. Burns, New York; C. R. King, Chicago; F. E. Harding, Cleveland; F. H. Larrabee, Kansas City, and A. E. Rowe, San Francisco.

Magnavox Radio Reception Gets Some Good Publicity

The reception qualities of the Magnavox receiving set were emphasized in a letter recently received by R. A. O'Connor, manager of foreign sales of the Magnavox Co., Oakland, Cal., from W. H. Slater, of Rankin & Cherrill, importers and jobbers of electrical and radio supplies, Vancouver, B. C., who wrote, in part:

"I am enclosing a newspaper clipping from the Vancouver Daily Star, showing what we

Japan's Best!!

Gramophones,
Gramophone Needles
and Records

ALL SORTS OF MUSICAL
INSTRUMENTS

Write for catalogs and particulars

Nonaka Trading Co.

4-chome, Moto-machi - Yokohama, Japan

can do with a Magnavox set in Vancouver. The Calcutta station I received on the loud speaker, but the rest on head phones, namely: 2BL Sydney, 4QG Brisbane and 5CL Adelaide. All stations came in very clear at times, but the fading was bad, also static, etc. They mention four Australian stations, but I only received three, but had JOAK, Tokio, Japan, very clear on the same morning."

This is concrete evidence of the quality of Magnavox radio sets.

Bell & Howell Camera Used at 12,000 Feet Elevation

Photoplay Filmed in the Canadian Rockies From Plane—Products Made by Bell & Howell Co. Used by Most Professionals

High altitudes seem to hold little difficulty for the users of Bell & Howell motion picture cameras, for the accompanying illustration shows a camera which was operated at an



Bell & Howell Camera Fastened to Plane elevation of 12,000 feet in the Canadian Rockies in the filming of a photoplay. With the camera securely fastened to the wings, all of the close-ups of the actors in the plane were taken while in the air. In the foreground Lionel Barrymore, who starred in the picture, is shown enjoying the brisk mountain air and a cigarette between scenes.

Ninety-five per cent of the professional motion picture cameras in use to-day are "Standard" cameras, made by the Bell & Howell Co., the prominent Chicago firm, which recently turned its attention to the music-radio dealer as an outlet for the Filmo, a motion picture camera for home use in the taking of personal "movies."

VAN VEEN SOUNDPROOF BOOTHS

are more necessary than ever before. You cannot demonstrate the wonderful volume and beauty of tone of the improved talking machine and records without booths. The new instrument has unlimited possibilities. Meet it half way by adequate demonstration.

Complete equipment for musical merchandise dealers. Write for details and catalogue.

VAN VEEN & COMPANY, Inc.,

313-315 East 31st Street, New York City
PHONE LEXINGTON 9956-2163

SHOWERS

Selectivity
Distance
Volume
Tone
Foley Horn
Utah Unit
Guaranteed



Model 448. Top 17" x 32"
 Height 40"
 WALNUT ONLY

*Deliveries—one or
 carload at once*
*Exclusive Sales
 Franchise*
*Wide Margin
 of Profit*
*Prices
 Amazingly Low*
*Dealers Make
 More on Showers*
*You Can Make
 More—NOW!*

Showers Brothers Company, the largest furniture manufacturing organization in the world, was established in 1868. Showers' gross sales on furniture run over ten million dollars a year. This enormous business has been built on outstanding commercial values and a fair sales policy to dealers. Over nine million dollars of manufacturing assets back every Showers' Console Radio on your floor.



*This Year's Style
 in Radio!*
All Metal Shielded Construction.
6 Tubes. 1 Dial Control.

Take your agency for radio from a manufacturer who is equipped to produce A-1 merchandise on a quantity as well as a quality basis. The fact that Showers can ship you one or a carload of console radios at once indicates the enormous size of our manufacturing industry. The fact that Showers produces on an economic basis means a

wider margin of profit for the dealer, with retail prices that more than meet all competition.

Write or Wire Chicago Office Today

SHOWERS BROTHERS RADIO DIVISION

914 SOUTH MICHIGAN BOULEVARD—CHICAGO, ILLINOIS

Main Factories:—Bloomington, Indiana

SATURDAY EVENING POST

readers own more radio sets than the subscribers to any other publication.

Demand

Music Master

Horn Speaker

The
Distinct Musical Instrument
of Radio

No Mutilation of Tone



14-inch mahogany wood bell. Cast aluminum tone chamber, and the MUSIC MASTER reproducing unit.

an ideal
Christmas gift

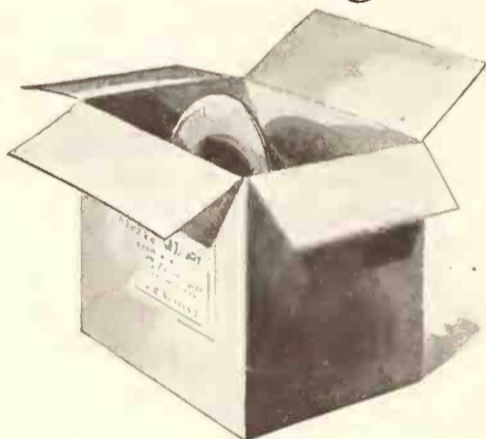

The complete MUSIC MASTER Horn Speaker is packed in indestructible cartons and with safety can be shipped anywhere.

Price \$22
Complete

If your dealer cannot serve you, order direct. Colored illustration sent free on request.

Do Not Accept a Substitute

Music Master Corporation
David S. Ludlum, Trustee
Betzwood, Pa. P. O. Port Kennedy

This advertisement appeared in the Saturday Evening Post, November 27th

Metropolitan Victor Dealers Plan Publicity Drive in Behalf of Orthophonic

Association Adopts Motion to Appoint Committee of Dealers to Co-operate With Representatives of Distributors to Carry Out Publicity Plan—Hear Interesting Talks

The adoption of a motion to appoint a committee of metropolitan Victor dealers to co-operate with representatives of the New York Victor distributors to devise ways and means of securing publicity for the Orthophonic Victrola in the metropolitan district was the outstanding feature of the regular monthly meeting of the Metropolitan Victor Dealers' Association, held at the Cafe Boulevard on Wednesday, November 17. The suggestion that some such committee be appointed was first made by Joseph H. Mayers, head of the International Phonograph Co., and it was put in the form of a motion by A. H. Mayers, proprietor of the music stores operating under his name. The motion was carried unanimously. J. Newcomb Blackman, president of the Blackman Talking Machine Co., Victor distributor, spoke in support of the plan and stated that he, as head of his company, would afford dealers the utmost of co-operation in bringing the Victor line to the attention of every resident and visitor of the city of New York. Others who took part in the discussion on this motion were Charles Mason, of the New York Talking Machine Co.; Paul Carlson, of Charles H. Ditson & Co., and William Mayers, secretary of the Association.

Ralph Cron, Eastern district sales manager of the Victor Talking Machine Co., was the principal speaker of the day, and he discussed the subject of "Quality Merchandising." In his talk Mr. Cron stated that while advertising was a necessity in bringing a product to the attention of the public, it, in itself, was not enough to make sales. He urged dealers to make group demonstrations, either in their stores or before assembled members of social and civic associations. He stated that the Victor Co. is following the demonstration route by playing the Auditorium model Orthophonic before thousands at all gathering places. He touched on the new style of the Voice of the Victor and said that it was, in a fashion, a sales manual to be read and studied by the dealer, and that in future issues it would contain the experiences of Victor dealers from all over the country.

Mr. Carlson seconded the vital necessity of continuing the education of the public to the desirability of the Orthophonic through demonstrations. He also said that dealers and their salesmen should thoroughly acquaint themselves with the devices of the new instrument such as automatic stops, etc., stating that many a sale is lost through carelessness concerning some small detail of the Orthophonic. Mr. Blackman then gave an interesting talk, saying that as the Victor factory had been modernized to meet the demands for producing the new Orthophonic line, so, too, must the trade progress in order to meet the competition of other industries, such as the automobile, electric refrigerator, etc.

William Mayers, one of the executives of the A. H. Mayers retail stores, said that in his opinion the present-day Victor advertising was inclined more to building prestige and helping the small-town and rural dealer. He advocated more spectacular newspaper advertising and billboard advertising in the larger cities to bring the buying public to the dealers' stores.

Mr. Mason, the next speaker, gave two suggestions as possible aids for stimulating sales. The first of these was that the dealer should circularize and in other ways follow up every purchaser of a radio receiver and seek to have him attend a demonstration of the Orthophonic; the other plan was to use the telephone to follow up former customers who have not been in the store for some time and prevail

on them to have the new instrument demonstrated. P. Silverman, of C. Bruno & Son, Inc., Victor jobber, spoke on the laxity of dealers in failing to push the new Orthophonic recordings and he said that many of the record clerks in retail stores throughout the city are of a low grade and are very careless in attending customers. He suggested that dealers classify their customers according to the type of music they prefer and send classical, standard or popular release listings to those interested in each class. Another suggestion of Mr. Silverman's was that dealers might employ schoolboys to make a house-to-house canvass selling album record sets, paying the boys a set commission.

Sherman, Clay & Co. Report Record Business for Year

Trade for First Ten Months of 1926 the Best for Any Ten Months in the History of the Company—Sales Show \$1,000,000 Increase

SAN FRANCISCO, CAL., December 6.—Sherman, Clay & Co., who issued a report early in the Fall for the first nine months of the year, now report one of the best ten months in the history of this more than fifty-year-old company.

Net sales for the ten months of the year are more than \$1,000,000 in excess of the same period last year.

Net profits before Federal income taxes, but after depreciation, were more than twice annual dividend requirements of the prior preferred stock, amounting to approximately \$200,000. Since offering of this stock, three years ago, more than \$141,000 par value of stock has been retired.

The ratio of current assets to current liabilities is in excess of three to one and net current assets per \$100 of prior preferred stock outstanding is more than \$200 per share.

It is believed that business for the remainder of the year will hold its own with 1925, and that the company will exceed its greatest year in the past by a wide margin. The last two months of each year have always been those of the greatest sales for the company.

F. E. Yahr Finds Great Super Ball Antenna Activity

Fred E. Yahr, president of Yahr-Lange, Inc., Milwaukee, Wis., made a flying trip through Ohio during the latter part of November in the interest of the Super Ball antenna, which his firm distributes nationally. He visited Super Ball distributors in Dayton, Columbus, Cincinnati and Indianapolis, attending the Radio Exposition in the last-named city and appointing several jobbers who will cover the southern Indiana territory. The popular antenna has made splendid progress in this particular territory, according to Mr. Yahr, and also in Michigan, the Detroit Electric Co. recently having received a carload shipment, numbering over 2,300 Super Balls, which are to be distributed to dealers through the main office and several branches of the enterprising Detroit concern.

Yahr-Lange, Inc., is also sponsoring large space newspaper advertisements throughout the country, the Super Ball campaign appearing in the press of Milwaukee, Wis.; Kansas City, Mo.; Omaha, Neb.; St. Louis, Mo.; Dayton, O., and other large trade centers.

The Barber Music House, Great Falls, Mont., reports a big demand for Gulbrandsen pianos.

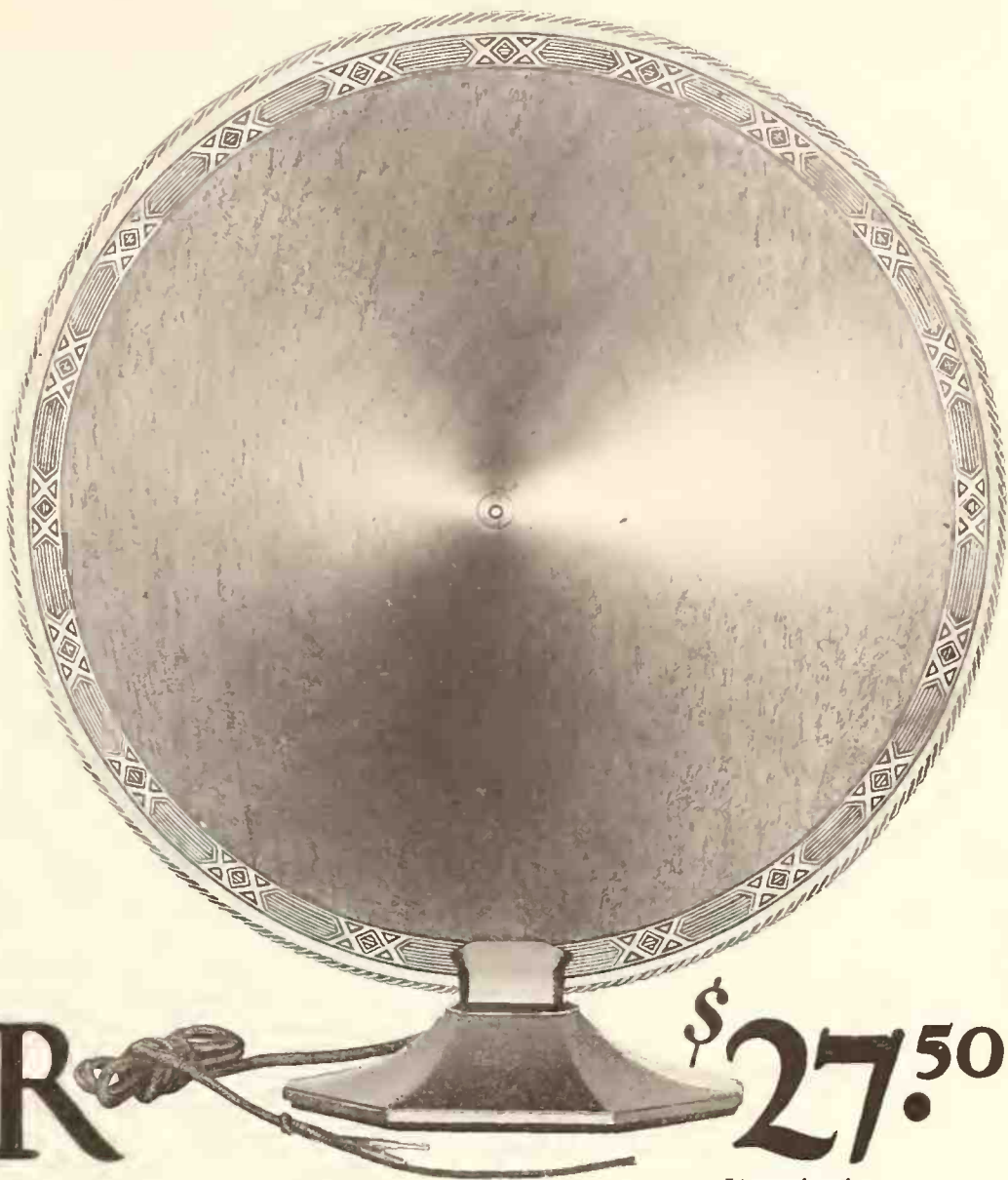

SANDAR

\$27.⁵⁰

*Licensed under
Lektophone Patents*

Spells Success

DEALERS and fans alike continue to register approval of the new Sandar Speaker in no uncertain terms, and we're hard put to it to keep ahead of the demand. Sandar's exceptionally low price, \$27.50—lower, in fact, than any other licensed speaker of its size—combined with its uncanny receptivity and attractive appearance, has made it a universal and immediate favorite.

We as its manufacturers realized fully, of course, the downright merit of Sandar before we introduced it a few months ago, but we hardly expected the wave of popularity to engulf us so soon. No question about it—Sandar spells success to those fortunate and quick enough to take it on. Write us today for terms and full information.

SANDAR CORPORATION

Crescent Plaza Building

Long Island City, New York

SANDAR SPEAKER

Retail Trade in the Buffalo District Profiting by Pre-Holiday Buying Rush

Radio Sales in Western Part of the State Reach New High Peak—Higher-Priced Instruments Lead in Demand—Portables Selling Briskly to Gift Buyers, Report Dealers

BUFFALO, N. Y., December 9.—Radio sales in the western New York district reached a new peak following the show, and have continued on an upward trend since that memorable week. Most pleasing to the trade is the fact that the greatest demand is for higher-priced and quality instruments and sets.

Strong Demand for Ortho-sonic

Federal sets are being shipped from the distributing office of the Buffalo Talking Machine Co. as rapidly as they are received. There is an overwhelming demand for Ortho-sonics in the \$300 and \$400 class, according to M. O. Grinnell, sales manager. He also reports an excellent Victor business in practically all models.

Working Nights to Meet Demand

Curtis N. Andrews is particularly busy this month, endeavoring to give the service which has made the house of Andrews famous, in spite of the great demands made on this Victor and Fada jobber during the pre-Christmas rush. The entire force has been working at night, sending out shipments as rapidly as they are received. Recent new Fada accounts are Denton, Cottier & Daniels and Kaepfel Bros.

Revive Victor Department

E. W. Edwards & Sons, one of the city's largest department stores, have revived their Victor department, and have opened an attractive new division on the fourth floor of the Main street store. William Herbert has been placed in charge of the department.

Portables Popular as Gifts

Portable phonographs are showing renewed activity since a lull that became evident early in September, according to F. D. Clare, manager of the Iroquois Sales Corp. Carryolas and Artone are leaving the floors of this jobbing house for all sections of this territory this month. Mr. Clare reports two new and important Crosley accounts, one with the Household Outfitting Co. and the other the G. C. Murphy Co., a Broadway dealer. Foreign Okeh record sales are very pleasing, he said. A new addition to the radio department of the Iroquois Sales Co. is the Bremmer-Tuly Counterphase.

Radio Business Swamps Trade

Practically all members of the retail trade in-

terviewed this week are fairly swamped with radio business. John Kibler and Schwegler Bros. have each taken on six new men since the radio show, who devote their time entirely to the radio end of the business. Adam, Meldrum & Anderson and any number of other dealers have also added to their force of radio experts. Albert Schwegler said he also is doing a very brisk Victor business. Mr. Kibler said although his business is little more than two years old, he contemplates erection of a much larger store.

Association Entertains Whiteman

Paul Whiteman, Victor artist, was tendered a reception by the Victor Dealers' Association in western New York in the Hotel Statler during the latter part of November. He was accompanied by several members of his orchestra, which furnished a novelty musical program. Practically every Victor dealer in the city featured Whiteman records in special window displays and advertising during his appearance. Following the luncheon and entertainment program officers of the Association were elected as follows: John Fisher, president; Dayton Evans, treasurer; Arthur Clark, vice-president, and Walter Bruel, secretary.

C. W. Mason in New Post

C. W. Mason has joined the sales staff in the radio department of Adam, Meldrum & Anderson. He is well trained and experienced in radio. He formerly was in the radio service department of Neal, Clark & Neal.

Adding to Floor Space

The Brunswick Shoppe is oversold in all models of the Panatrop, according to C. O. E. Curtis, manager. Mr. Curtis said he could not hope for a more satisfactory Brunswick business, but is somewhat grieved over the shortage of models. The store is doubling its present floor space.

G. M. Jensen Promoted

Announcement that George M. Jensen, manager of the local Brunswick distributing office, is leaving Buffalo, is received by the trade with regret. Mr. Jensen will leave late this month to take up new duties in the Pittsburgh office of the Brunswick Co. He will be succeeded in

the Buffalo office by Don Miller, who is an able and popular executive.

Brief but Interesting

Fire in the laboratory of the Federal Radio Corp. on Tuesday evening, November 30, destroyed valuable experiments of the research department, causing an inestimable loss.

Elmwood Music Hall was thronged to capacity by admirers of Mme. Schumann-Heink on December 3, when she gave her farewell concert in Buffalo. Victor dealers tied up.

The Radio Listeners' League of Western New York was incorporated recently and authorized by Justice Noonan.

The radio trade of Erie, Pa., has formed an organization known as the Erie Radio Trades Association. The meeting was addressed by S. C. Bettinger, past president of the Buffalo Radio Trades Association.

Howard Weber, formerly with the Levis Music Store in Rochester, has been made manager of the Robert L. Loud Music House, Buffalo. He succeeds Edward Heintz, who has been made manager of the phonograph department of the Rudolph Wurlitzer Co.

Thos. A. White, president of the Buffalo Radio Trades Association, and head of the Wholesale Radio Equipment Co., is the proud father of a new daughter.

Paul J. Seno, noted musician, formerly with John Philip Sousa's Band, and also with Arthur Pryor's Band, died at his home in Buffalo.

Bosch Library Ambotone Introduced to the Trade

The Library Ambotone, a cone type reproducer of distinctive appearance at a modest price, is the latest addition to the radio products



Bosch Library Ambotone

of the American Bosch Magneto Corp., Springfield, Mass. The Library model is tastefully decorated in the oriental motif, in black and gold. Wood is used in its construction, for mellowness of tone, according to Bosch officials. The Library Ambotone is offered as a guest room radio reproducer, or as an extra speaker which may be hooked up in any part of the home.

Christman With Cameron Co.

E. A. Christman, for twenty years connected with the Victrola department of the Ashbach Music House, Allentown, Pa., has become manager of the same department of the Cameron Piano Co., 928 Hamilton street, the same city. Mr. Christman ranks as one of the authorities on talking machines and records by reason of his long years in the field.

I. S. Burk has been made manager of the radio department of the Jordan Music House, Charleston, S. C., in which city he has become widely known as a radio expert.

We want to help you make the coming
year one of music; and let it be

OKEH
TRUE ONE

Music

*Christmas cheer and a
happy New Year*

OKEH PHONOGRAPH CORPORATION

NEW YORK DISTRIBUTING DIVISION

15-17 West 18th Street

New York City

HOMEPower SALES are Breaking all Records



Are you getting your share of this business?

Every radio owner wants a National Homepower, the one "A" power unit that is compact enough to fit into practically all cabinets, is trouble proof, durable and sells at a fair price.

Sales are proving that Homepower is right

in every way. And a strong, consistent National advertising campaign is increasing Homepower buyers by the thousands.

Line up with National NOW. Get your share of the easy sales and profits that go with handling this improved unit. See your jobber or write us today.

NATIONAL LEAD BATTERY CO.

General Offices: ST. PAUL, MINN.

Factories: St. Paul, Chicago, Kansas City, Los Angeles

Branches: New York City, Dallas, Oakland, Atlanta, Portland (Ore.), Baltimore

NATIONAL HOMEPower
RADIO "A" UNITS

TYPE 1
TYPE 2
TYPE 3

For Sale by Reputable Dealers and Jobbers Everywhere

The Trade in **BOSTON** and **NEW ENGLAND**

JOHN H. WILSON, Manager
324 WASHINGTON ST., BOSTON, MASS.

Brunswick Boston Branch Plans Move to Large New Quarters After the New Year

Four-Story Building Being Remodeled to Suit Needs of Growing Brunswick Business in This Territory—D. Comerford With Eastern Co.—Many Columbia Franchises Granted—The News

BOSTON, MASS., December 6.—The important piece of news of the moment in trade circles here is the contemplated removal of the Brunswick-Balke-Collender Co. from its present stand at 80 Kingston street to 314-316 Stuart street, more toward the Back Bay section. The building to be occupied is four stories high. The company needs the larger space because of the growth of business. The building is now being made over to suit the needs of the Brunswick business. The move will be made right after the new year and there will be every facility for the expeditious handling of business.

Gramophone Society to Meet

The next meeting of the Boston Gramophone Society will be held on the evening of Tuesday, December 7. At this writing it has not been decided just where it will be, but most likely in a hall. The last meeting was held at the Oliver Ditson Co.'s store through the courtesy of the publishing house and Henry Winkelman, manager of the Victor department. The secretary of the society is Robert Donaldson Darrell. It will be recalled that one of the prime purposes of this organization is to bring together persons interested in the better grade of music as represented by phonographic recordings. The official organ of the Society is the Phonograph Monthly Review.

Shortage of Popular Models

Manager Herbert Shoemaker, of the Eastern Talking Machine Co., can't get enough goods to supply the demands of dealers, and to prove his contention he indicated a chart wherein there were orders for 500 Victor machines of a certain type that could not be supplied.

D. Comerford With Eastern Co.

Dwight Comerford, who has had a wide experience at the Western Electric Co.'s Springfield plant, has become attached to the Eastern's headquarters in Essex street. He also has been for three months at the Victor plant at Camden. A new room at the back of the building has been equipped as an efficiency service

department and this will be for Mr. Comerford, whose interests will be focused on radio.

P. J. Burrell Joins Drayton-Erisman, Inc.

Percy J. Burrell has become identified with Drayton-Erisman, Inc., Avery street, and is devoting his attention to the talking machine end of the business, this concern carrying the Pathé-phonics. The field staff now consists of Herbert Libby, who has Maine and New Hampshire; John J. O'Hara, who has southeastern Massachusetts, Wesley N. Boynton, western Massachusetts, and B. W. Farrington, eastern Massachusetts and Rhode Island.

New Brunswick Models Please

Local Brunswick business has been very good and there has been a big demand among dealers for certain types of machines. The Brunswick just lately introduced the new P R 128 and 148 types, which combine certain units of the Panatope and the radio and it is of special interest that the first invoice of these was sold before it had left the car.

Many Dealers Add Columbia Line

During the last thirty days a number of dealers have taken on the Columbia outfit and some of those who have been ordering rather heavily of late have been the following-named: F. B. Emerson, Chelsea, Mass.; Livermore Falls Furniture Co., Livermore Falls, Me.; Denholm & McKay Company, Worcester, Mass.; Bailey's Music Rooms, Burlington, Vt.; Edward P. Lyon, Bethel, Me.; Bernard Blake, Freeport, Me.; Healy & Barnfield, Inc., Bristol, Conn.; Anzalone Bros., East Boston, Mass.; Eastern Furniture Co., Bangor, Me.; Clayton H. Kyle, Huntington, Mass.; L. P. Araldo, Andover, Mass.; Harvey's Music Parlors, St. Johnsbury, Vt.

Billy Parks, New England manager of the Columbia, is jumping around through the territory at full speed these days and everywhere he goes he is finding business considerably more than normal. Recently he was up in Maine, where he found George L. Donnelly developing his wholesale territory at a rapid rate; and he

has also been in Rhode Island and southeastern Massachusetts.

An expected caller here in a few days is George Jell, who is the Columbia artist contract man and who is coming here especially in connection with the appearance of some of the Columbia artists.

Brunswick Accounts Opened

Among new houses with which the Brunswick has hitched up in this field have been Forbes & Wallace, who have lately opened a new talking machine department in Greenfield; John D. McCarthy, Leominster; C. E. Bailey, of Wilton, Me., and Don Chamberlain, Kennebunkport, Me.

A. Shuffer Joins Brunswick Forces

A new man just taken on by the Brunswick, Inc., is Arthur Shuffer, a graduate of the New England Conservatory of Music, who will act as a salesman for the Brunswick with the State of Maine as his territory.

A series of sales meetings in the interest of the Brunswick instruments has lately been conducted with great success at the warerooms of some of the Brunswick dealers. Among those who have had such meetings have been the Jordar Marsh Co., in this city, the Atherton Furniture Company at its Portland, Lewiston and Waterville, Me., stores; the Bon Marche, Lowell; Forbes & Wallace, Springfield, and the Meikeljohn stores at Providence, Pawtucket and Woonsocket, R. I.

E. F. Sause a Visitor

E. F. Sause, manager of the export department of the Columbia, accompanied by his wife, was a Boston visitor at Manager Park's headquarters the latter part of October.

Sonora Activities

Manager Joe Burke, of the J. H. Burke Co., Sonora distributor, stated that business as a whole had been very good this Fall. Dan W. Lynch, Eastern Massachusetts representative for the Burke Co., spent ten days lately at Saginaw, Mich., going over the Sonora factory and familiarizing himself with the details of manufacturing the instrument.

Steinert Store Moved

The Brockton warerooms of M. Steinert & Sons has been moved into new quarters at another number on Main street, where it is now well located for the ever-increasing business that this store enjoys in the Victor line.

The Harvest Time Is Here

For Victor dealers who have properly prepared their stocks and their organizations to meet it, the day of opportunity is here. National interest in the new Victor products is now being developed into real sales with stocks available to meet all normal demands.



We can help you prepare to get your share.

Victor Exclusively

Oliver Ditson Co.
BOSTON

Chas. H. Ditson & Co.
NEW YORK

Gen. J. G. Harbord Discusses Radio Broadcasting

President of Radio Corp. of America Opposes Proposal to Limit Broadcasting Licenses to Period of Two Years

Declaring that the proposal to limit broadcasting station licenses to two years, as proposed by Congress, would discourage the creation of a permanent and efficient broadcasting service in the United States, Gen. J. G. Harbord, president of the Radio Corp. of America, recently discussed present conditions in the radio industry at a demonstration of transoceanic radio communication before the Brooklyn Chamber of Commerce at the Academy of Music in Brooklyn.

Gen. Harbord stated that radio communication should be encouraged, adding that no sensible investor would put \$2,000,000 into a radio station if it were to be subject to confiscation after two years. Radio also requires freedom of experiment, he said. The proposal to create a radio commission was attacked by Gen. Harbord, who declared that such a commission would require formal proceedings for the determination of minor routine matters and would tend to make radio control an agency for political manipulation.

"I believe in fair and wise regulation of utilities and trade practices," said Gen. Harbord. "The test, however, of such regulation is that it be in the interest of the public. Regulation which would retard the continued development of radio would not be in the interest of the public."

Gen. Harbord said that there can be no objection to the proper regulation of wave lengths, the need for it having been shown by the growing tendency to appropriate any desired wave length regardless of its prior use.

The occasion afforded an opportunity for an interesting demonstration of transoceanic and ship-to-shore radio communication, as well as the transmission of pictures by wireless.

Diamond T Radio Dealers Meet in South Bend, Ind.

Important Trade Gathering Attend Business Session and Banquet in Oliver Hotel

SOUTH BEND, IND., December 4.—The Diamond T Radio Manufacturers held a sales meeting at the factory in this city on November 20, which was attended by Diamond T representatives throughout the Middle West. In the morning meeting, sales policies, which have been enlarged and broadened, and technical details of the new models were explained to the representatives, who also listened to several addresses by directors of the company with reference to the 1927 advertising program.

Following the morning session a class in testing Diamond T receivers against competitive sets was held and following the tests further instructions were given by H. J. Tweed, Eastern sales manager; B. J. Schmidt, Western sales manager; C. L. Smith, president of the firm. At 6.30 in the evening the representatives were entertained as guests of the company at a banquet in the Gold Room of the Oliver Hotel. There were also present a number of Diamond T dealers, who were granted the privilege of addressing the gathering and expressing their enthusiastic opinions of Diamond T receivers. Mr. Tweed and Mr. Schmidt also talked to the salesmen at the banquet, pointing out ways and means of assisting dealers in their territories in building up sales and advertising programs. According to a report made by the Diamond T executives, the firm is steadily enjoying a gratifying amount of business, the factory having been forced to increase its production to the limit, and a recently built addition to the eighty thousand feet of floor space is already in use.

Merry Christmas

to all our friends who have co-operated with us in putting the

BERG ARTONE LINE

on the map in a large way in 1926

Now We Say Again

Watch



in

1927

—Particularly our important announcement in the next (January) issue of the Talking Machine World.

BERG A. T. & S. CO., Inc.

LONG ISLAND CITY

NEW YORK

B. J. Sheppard Co. Opens New Store in Savannah, Ga.

Seven Thousand People Attend—Gulbransen Player Figures Big in Musical Program

SAVANNAH, GA., December 8.—The recent formal opening of the new store of the B. J. Sheppard Co. was one of the most successful and interesting inaugurations of a new business building in the history of this city. On the opening day 7,000 people streamed into the store, which was splendidly decorated for the occasion, to inspect the merchandise, which was displayed in an attractive way.

An interesting feature in connection with the opening was the part which J. E. Albineau's son and daughter took in it. Mr. Albineau is the representative for the Gulbransen Co., Chicago, in this territory. His son played the Gulbransen piano by roll, in the window of the store, while his daughter danced the Charleston. The crowds that stood around the

window to view this act blocked the streets.

In connection with the opening of the new Sheppard store, the Savannah News issued a special edition, one of the features being a half-page advertisement of the Gulbransen Registering Piano, calling attention to the excellent business built up on this product by the Sheppard Co. in the past four years.

On the evening of the opening Mr. Sheppard gave his organization and the visiting manufacturers' representatives a dinner at which business plans for the future were discussed.

Patent Office Is Again Falling Behind in Work

WASHINGTON, D. C., December 6.—The United States Patent Office again is falling seriously behind in its work, as a result of reduced appropriations which prevent the employment of a sufficient number of examiners, it is declared by Thomas L. Robertson, Commissioner of Patents, in his annual report.

Slowing Down at Motor Factories Does Not Affect Retail Trade in Detroit

Seasonal Slackness in Motor Industry a Regular Occurrence and Is Anticipated by Workers—Holiday Trade Expected to Be Best Ever—Wurlitzer Co. Moves—Other News

DETROIT, MICH., December 6.—If you were to read and believe some of the dispatches printed in various newspapers and trade journals about the unemployment situation in Detroit you would naturally be under the impression that the "motor city had gone to the dogs" and that all the merchants were suffering. In justice to Detroit and its retailers, the writer wants to put you right—there is always a lull in the motor business before the holidays—some of the plants close down for inventory and, of course, it throws quite a number of people out of employment, but Detroit has been doing this so many years that locally we pay no attention to it and the merchants look for it. It is nothing that we who live in Detroit get worried over. The motor business has its seasons like all other lines of trade, and the wages paid during the busy seasons are so lucrative that when men are laid off they have a nest egg to carry them over. As a matter of fact, manufacturers and bankers look for 1927 to be the biggest and best year the motor manufacturers, and Detroit, have ever had.

Right now talking machine dealers are in the midst of the holiday season and judging from the reports The World correspondent is able to get this month's business will exceed anything of the past. In the first place, the retailer has more to offer as suitable Christmas gifts than ever before. He has the new improved talking machines, improved records, band instruments, radios, etc. They come at such assorted prices that the retailer can suit the pocket-book of any customer. Years ago it was only machines and records at Christmas time. See the difference?

The Rudolph Wurlitzer Co. is moving December 8 into its new home on Broadway, where it will occupy six floors of its own building, twenty stories high. A solid floor will be for talking machines and records. Mr. Quinn, the former manager of the Brunswick Shop, is the new Wurlitzer store manager in Detroit.

Directly across the street from the Wurlitzer store Grinnell Bros. have opened their tenth retail branch store in Detroit. It will carry a complete line of Victor records and Victor Orthophonics.

The Janney-Bowman Co., Park and Elizabeth streets, which recently added a talking machine department, reports that it is doing far better than was expected. The store has had quite a run on the Credenza Orthophonic model.

We find that quite a number of stores are putting up special books of records for holiday presents and expect to dispose of a great many, as they did last year.

Many talking machine dealers are attending the Monday noon luncheons of the Detroit Piano Club at the Union League Club. It is really sponsored by the officers of the Detroit Music Trades Association and although it is called the Piano Club it is for everybody in any way interested in the development of the music business and all its phases.

At the annual meeting of the Detroit Music Trades Association held a few weeks ago, Frank Bayley, Brunswick dealer, was re-elected president; and S. Roy Langs, of Weil & Co., secretary. The club intends to make quite a drive for new members during the coming Winter and hopes to secure every retailer handling musical instruments. Already most of the

downtown talking machine dealers are associated with the club.

All of our local jobbers handling talking machines, such as Grinnell Bros., Victor, Columbia Phonograph Co., Brunswick Phonograph Co., Yahr-Lange, Sonora distributors; S. E. Lind, handling the Adler Royal line, and others, say they will close the year with a greater volume of business than last, and that they see a very bright future for the talking machine and radio industry.

The latest types of Stromberg-Carlson five and six-tube receivers and also the cone speaker with "Stradivarian" soundboard are being featured by R. B. Henderson & Co., Detroit, Mich., through the medium of strong window displays. Recently the firm had a booth at the Detroit Radio Show that attracted wide attention.

New Officers Head New York-Chicago T. M. Cos.

Chas. B. Mason in New York and Wm. C. Griffith in Chicago Elected Presidents of Respective Concerns

New officers were elected last month to fill vacant offices in the New York and Chicago Talking Machine Companies, Victor distributors in those cities. Charles B. Mason was elected president of the New York Talking Machine Co., Howard B. Merritt was selected secretary and treasurer and H. Cunningham, Jr., now fills the position of sales manager.

William C. Griffith was elected to the office of president of the Chicago organization with R. P. Alexander, secretary-treasurer, and Charles W. Hyde, sales manager. Dan A. Creed resigned from the company's vice-presidency and as general manager. There are no other changes in either of the organizations.

All of the new officials have been connected with these organizations for a period of years and are well and favorably known throughout the trade.

Announces Second Bosch Metropolitan Distributor

Auto Hardware & Equipment Co. to Distribute Line Under Direction of Louis Jay Gerson, Manager of the Radio Department

The appointment of the Auto Hardware & Equipment Co., New York, as a second distributor in the metropolitan zone for Bosch radio products, has been announced by A. H. Bartsch, general sales manager of the American Bosch Magneto Corp., Springfield, Mass. Coincidentally, Carl Kaufman, president of the Auto Hardware & Equipment Co., announced the appointment of Louis Jay Gerson as manager of the distributing company's radio department. Mr. Gerson is well known in the music-radio field, having been affiliated with the General Phonograph Corp. and the Music Master Corp. He was also in charge of the talking machine and radio purchasing department of John Wanamaker, New York department store, and has enjoyed wide experience in sales and merchandising practices of phonograph and radio manufacturers and wholesalers.

Weber-Rance Opens Branch

Well-known Radio Distributor Opens New Branch Office in Brooklyn

A new Brooklyn branch office, located at 1271 Bedford avenue, has been established by the Weber-Rance Corp., New York jobber, for the convenience of its Brooklyn and Long Island dealers. Adequate showrooms will be maintained at that address where the Bosch, Ferguson and Crosley radio receivers will be on display as well as the various lines of radio accessories handled by Weber-Rance.

The Redtop Radio Tubes ARE Better

Reg. U. S. Pat. Off.



Super Detector
\$4.00



Power Tube
\$4.50



201A Type
\$2.00



Full Wave
Rectifying Tube
\$6.00

EVERY TUBE ABSOLUTELY GUARANTEED

Specials

We also make Special Radio Frequency Tubes that operate on all stages but Specially Recommended for R. T.

Also if you have sets that squeal—send us the name of the set and we will send you tubes that will work wonders with it.

The Q R S Music Company

Chicago

New York

San Francisco



BRILLIANTONE

Wishes You a
Merry Christmas
and a
Happy New Year

BRILLIANTONE STEEL NEEDLE CO.
OF AMERICA, INC.
370 Seventh Avenue New York City

Pittsburgh Dealers Anticipate Record-Breaking Radio and Phonograph Business

Consistent Activity in Radio and Talking Machine Lines Leads Dealers to Predict a Banner Holiday Business—Demonstrations Aid Sales—Retailers Add Radio Lines

PITTSBURGH, PA., December 7.—Sales of phonographs, records, radio receiving apparatus and accessories have shown a marked trend toward breaking holiday records. It is the opinion of the leading dealers in the Pittsburgh territory that with the present rate of sales keeping up until Christmas Eve a new high mark for sales of talking machines and records will have been established.

Demonstrations Win Sales

One of the outstanding announcements made in the trade here was that by the Kaufmann & Baer Co., when they gave extensive publicity to the Eckharmonic. This instrument is on display in the talking machine department of the firm and daily demonstrations are being given. Kaufmann & Baer are also featuring the Victrola and the new Columbia Viva-tonal and are giving daily demonstrations to their patrons in the auditorium.

Hundreds of persons flocked into the auditorium of Kaufmann's (The Big Store) and the Kaufmann & Baer Co. the past week to listen to recitals given by the new Orthophonic Victrolas that were on exhibition at the Sesqui-Centennial in Philadelphia.

Experiencing Stock Shortage

George Gray, manager of the sales department of the C. C. Mellor Co., stated that business in the Victor and Brunswick line was much better than had been expected. He said: "Our main trouble appears to be to get the merchandise fast enough to fill orders."

How Edison Dealer Promotes Interest

"The Romance of Music," from the Spinnet to the New Edison, was presented to an audience of over 1,200 people in the auditorium of the

Roosevelt Junior High School, at Altoona, Pa., by Helen Davis, soprano, and Victor Young, pianist composer. The presentation was tendered by A. J. Harter, Edison dealer of Altoona.

Add Popular Radio Lines

Volkwein Bros., the well-known music dealers of the Steel City, have installed a line of the Bosch radio sets as well as the Atwater Kent line. The firm have given over the third floor of their building to the display and demonstration of the sets. The firm have been meeting with marked success in the demonstrations that are given of the Bosch radio set in homes of prospective buyers, most of these demonstrations resulting in sales.

New Brunswick Model Pleases

At the local offices of the Brunswick Co. Manager Markham stated that business for the newest of Spanish styles in phonographs put out by the firm was quite pleasing and this, coupled with the good demand for the Brunswick Panatropé, indicated that the holiday season would be an exceptionally brisk one.

Viva-tonal Scores With Trade

The Columbia Viva-tonal instruments are coming into their own in the Pittsburgh territory in a highly satisfactory manner, according to Manager Nichols, of the local Columbia offices. Old Columbia dealers are very enthusiastic over the new instruments he stated, and they are featuring them successfully and profitably.

Ideal Phono Parts Co. Busy

The Ideal Phono Parts Co., of Pittsburgh and Cleveland, of which Paul Susselman is president, reports a very satisfactory volume of

business. With the addition of the Cleveland offices the company is in a magnificent condition to serve the dealers in the Pennsylvania, Ohio and West Virginia territory. The recent announcement that the Ideal Phono Parts Co. is a distributor of the new Pathé phonograph made by the Pathé Phonograph & Radio Corp., Brooklyn, N. Y., and also the Pathé cone loud speaker, is an indication of the progressive spirit of the company. Fred C. Schuyler, sales manager of the company, reports that every indication shows that the December sales will be beyond its fondest expectations. The Ideal Phono Parts Co. carries one of the largest stocks of phonograph repair parts and accessories outside of New York City.

Player-Tone Co. Rushed

Extraordinary activity is noted at the offices of the Player-Tone Co., due to the fact that orders for the new Saxophonic consoles and uprights have been coming in from the territorial representatives in "bunches," literally speaking. I. M. Goldsmith, president of the company, who is an outstanding figure in talking machine manufacturing circles, is much pleased over the very favorable reception that is being given to the twelve models of the new Saxophonic consoles and uprights.

Sonora Sales Grow

Sonora dealers in the Steel City and vicinity are much pleased over the sales that are being made of the new Reproducing Sonora. The Pennsylvania Phonograph Distributing Co., with offices at 917 Wabash Building, Pittsburgh, report that dealers in the territory who handle the Sonora are finding it a comparatively easy matter to sell the new line to their patrons.

News Brieflets

The W. F. Frederick Piano Co., Victor dealer, has opened a new store at Bradford, Pa.

The G. W. P. Jones Music Co., of Washington, Pa., Victor, Edison and Columbia dealer, the past week celebrated the twenty-fifth anniversary of the founding of the business.

The S. Hamilton Co., Victor dealer, has opened a branch store at 930 Homewood avenue, Pittsburgh. This makes the fifth store under the control of the firm.

New Radio Invention by Dr. F. A. Kolster Announced

Device Is Named the Kolster Mobile Radio Beacon—Federal Telegraph Co. Breaks Records for Ship-to-shore Communication

All daylight radio records for direct communication between ship and shore are said to have been broken recently when the Federal Telegraph Co., at San Francisco, a subsidiary of Federal-Brandes, Inc., maker of Kolster radio sets and Brandes speakers, communicated with the S. S. "President Wilson" 3,120 miles west of San Francisco. The best previous daylight record is said to have been about 2,400 miles.

Announcement of a new radio invention, which is designed to prevent collisions between ships passing in a storm or fog, has also been made by Federal-Brandes, Inc., following exhaustive tests along the Pacific Coast by the United States Lighthouse Service and other agencies. This new device has been named the Kolster mobile radio beacon in honor of its inventor, Dr. F. A. Kolster, who also invented the radio compass and designed the Kolster receiving set for the home. Dr. Kolster also invented the radio fog signal and the decimeter for measuring wave lengths. He is at present in charge of the research laboratories of Federal-Brandes, Inc., at Palo Alto, Cal.

Market New Radio Accessory

A new radio accessory, the Time-Lite, has been announced by the Time-Lite Clock Corp., New York. This clock, attached to the radio receiver, is said to start, stop and restart operation of the receiver on any specified hour or minute desired. It is finished in mahogany.

Get Your Copy NOW!

Big New Udell Catalog



No. 746
Radio Cabinet
Specially for Atwater Kent Model 20 Compact and Model 30. A typical example of the many splendid UDELL values.



You can make friends and money by stocking and selling this line now! UDELL Radio Cabinets, Tables, Player Roll Cabinets and Console Talking Machines. Our complete lines are on permanent display at BOTH the American Furniture Mart (space 1029), Chicago; and the Furniture Exchange (space 314), 206 Lexington Ave., New York. It will pay you well to see them there!



Write for Special New Radio Catalog No. 86 NOW!—The Greatest Values in Our Half-Century Experience

The UDELL WORKS, Inc.

Established 1873

28th St. at Barnes Ave.,
INDIANAPOLIS, IND.



It will pay you to order at once by special delivery letter or telegram

LIST

\$ 15

(less regular discount)

Sales are running way ahead of expectations—proof that the Nifty looks like and is greatest value in the trade today.



FULL-SIZED CASES
in all colors

Size—Tone Appearance

Excellent reproducer and tone arm. *Never before equalled at this price!*

You hardly can tell the Nifty from any standard \$25 portable. It's as big, as well made, and has the tone. The case is a wonder,—specially braced and finished handsomely. Equipped with tilting record pocket.

Consolidated Talking Machine Co.

Consolidated Building

227-229 West Washington St., Chicago

Minneapolis: 1121 Nicollet Ave.

Detroit: 2957 Gratiot Ave.

The Trade in PHILADELPHIA and LOCALITY

Shortage of Most Popular Instruments Felt Throughout Quaker City Territory

Lively Demand Experienced as Holiday Gift Buying Gets Under Way—Distributors Making Strong Effort to Keep Trade Sufficiently Stocked—All Lines Move—Activities of Month

PHILADELPHIA, PA., December 9.—Approaching holidays have been anticipated by the trade and the public through a generous patronage of the talking machine industry and so the Yuletide month opens with lively business for both dealer and the manufacturers of the nationally known and newest types of machines. The only cloud on the horizon is the inability to obtain goods. The demand for certain numbers of the newer styles of talking machines and phonographs is far in advance of the supply and likely to bring about a similar shortage of Christmas stocks as that which occurred last year.

Make Strong Effort to Supply Trade

Wholesalers have been shipping to the retail trade just as soon as stock is received from the manufacturer, so that no delay is occasioned by the rehandling of stocks and a better service is made available in speedier assignment of orders on hand. It is difficult for the distributors to meet all demands of their patrons in the retail trade, owing to the fact that they must await factory convenience in shipments of talking machines. Every effort is being put forth to apportion incoming goods so that dealers may have at least a few of the much-wanted designs in time for the holidays.

Records are fully as much in demand for the

holidays as the talking machines. Orders are mostly for the popular dance recordings and song hits. Many of the distributors have prepared Christmas lists for the trade, so that they may have a ready service for vocal or instrumentations of those recordings which are particularly adapted for the Yuletide season.

Features Christmas Record List

Among the distributors having at hand a specially prepared list of the holiday numbers, compiled by the head of the record department, Raymond Boldt, of the Philadelphia Victor Distributors, Inc., 835 Arch street. Under the direction of the manager of the record department an attractively designed holiday poster and list has been compiled. This has been sent to the dealers and may be used for window decoration or for the inside displays and reminder to customers that the record lists may offer an appropriate gift. The lists are compiled from foreign and domestic recordings.

Phonograph Society to Meet

The second of the series of meetings which are designed to promote an interest in the recordings of good music and other trade promotions of the better class of record entertainment will be held on December 14 by the Philadelphia Phonograph Society at the local offices of the Brunswick Co., under the

auspices of Philadelphia Manager George A. Lyons. With President Fred Rauser presiding, there will be a gathering of the sixty members already enrolled and it is expected that many new advocates of the movement will be listed in the membership when the December session is held.

New Sonora Model Popular

So favorably received since its introduction last month, the newest of Sonora models, the Prelude, has been in strong demand in the Philadelphia territory, according to the Sonora Distributors, with offices in the Jefferson Building. Those dealers handling the new Prelude have been repeating orders continuously and factory headquarters are rushed with advance demand for the holidays. John H. DuBreuil, head of the Philadelphia headquarters, is now in the western section of the State, featuring most successfully the new type of Sonora. L. E. Hilduser, of the local offices, attended the recent opening of the Spangler Co., in Harrisburg. The Sonora Distributors have taken on the local distribution of the Philtrex B. Eliminator.

Personnel Changes at Brunswick Branch

As the Brunswick Co.'s newest Seville and Madrid types of machine grow in popular favor the local offices are shipping all goods received to the retailers just as soon as they are received from the factory. The staff of the Quaker City branch was submitted to several changes in the personnel in the November days. Former Assistant Manager Joseph T. Callahan has severed his connection with the Quaker City offices to join his former employers, the Colum-

(Continued on page 90)

HARRY A. ELLIS
Vice-Pres.

LOUIS BUEHN
Pres.

F. B. REINECK
Sec'y.

It is our sincere wish that you may have
A Merry Christmas and a very Happy
and Prosperous New Year

Philadelphia Victor Distributors, Inc.

835 Arch Street, Philadelphia

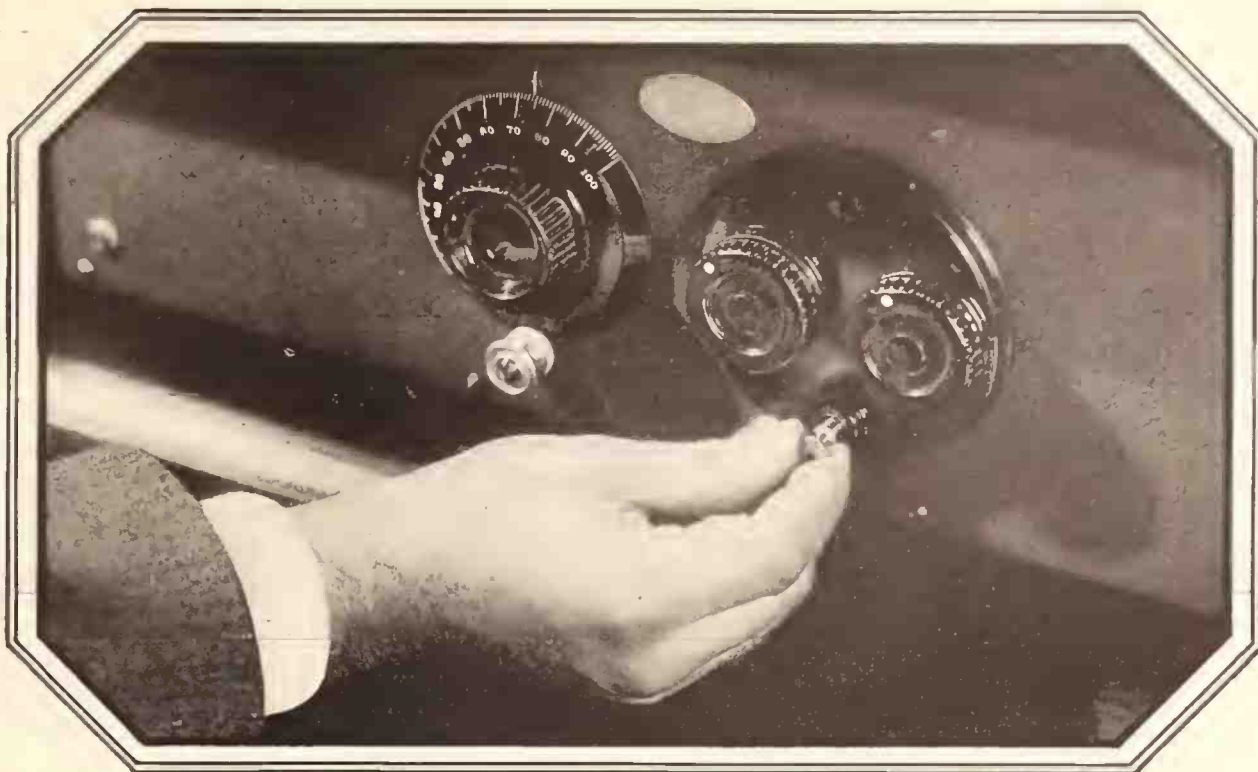

Automatic!

At one click of the set switch, Unipower supplies "A" power and controls "B" power automatically.

Give your customers unfailing radio power

~ operated **AUTOMATICALLY** by the set switch!

AT a click of the set switch, Unipower enables *automatic* radio operation *never-failing* "A" power *undisturbed* reception! That's why every customer needs it and will thank you for selling it to him.

With the addition of its remarkable new automatic switching feature, Unipower is again making radio history. It makes possible a power-operated set under one control,—the set switch,—without change in "B" power supply or set wiring. Complicated wiring is entirely eliminated—installation is as simple as that of a storage battery.

Other new refinements to a proven principle—the principle of trickle charge plus the indispensable rapid charge found only in Unipower—are present in the new 6-volt Unipower. Four trickle rates, operated by a simple dial, enable the user of heavily-worked multi-tube sets to adjust the power to the exact rate necessary to his individual set and hours of use.

Experts designed Unipower—time and performance have proven it totally fool-proof. There are no parts that need adjustment or that will need replacement during the normal life of the product. It is so constructed that it *cannot fail*.

Take advantage of the big Unipower months just beginning. Write now for the complete story of automatic "A" power. The Gould Storage Battery Co., Inc., 250 Park Avenue, New York.



For 199 tubes or equivalent AC-4. \$33.00.

Proven quality!

Unipower is manufactured by the makers of the famous Gould Batteries for automobiles, submarines, railways, farm-lighting, vehicle and fire-alarm service.

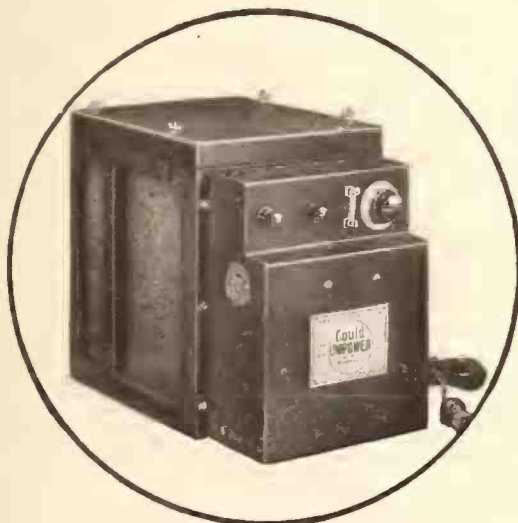

For 201-A tubes or equivalent AC-6HA. \$42.50

Unipower contains a Balkite charging unit of Gould design. It operates from alternating current 110-125 volt—60 cycle. Special models, 25-50 cycle, at slightly higher prices.

Unipower

A GOULD PRODUCT

AUTOMATIC "A" POWER WITH "B" POWER CONTROL

THE TRADE IN PHILADELPHIA AND LOCALITY—(Continued from page 88)

bia Phonograph Co., with the local forces. His duties at the Brunswick Co. headquarters here have been taken over by Paul Crooker, who comes from Boston. Mrs. Florence Hanéle, formerly with the New York offices of the Brunswick, is now in charge of the record department. District Manager George A. Lyon made a tour of the anthracite regions in the past month and attended the opening of the new store devoted exclusively to the Brunswick, the Werley Music House, of Allentown, Pa., and the dedication of the newly opened store of the Select Furniture Co., Wilkes-Barre. Having extended the retailing of Brunswick machines and records, the Select Furniture Co. has opened a store adjacent to its long-established business. The new store is under the management of E. W. Krause.

Kirk Johnson Co. Opens Improved Store

A newly renovated and enlarged store has been opened by the Kirk Johnson Co. in Lancaster, Pa., where during the past month the doors of the modernized home were thrown open for business as a preliminary holiday occasion for the display of the various lines of instruments handled by the firm and particularly for the talking machine department and its Victor and Brunswick models. A broadcasting station has been added for the exploitation of the Kirk Johnson store. The firm was remembered with many floral tributes by Philadelphia associates and friends, among them the Brunswick Co. and the Philadelphia Victor Distributors, Inc. W. W. Lorenzo, of the Philadelphia offices of the Brunswick Co., journeyed to Lancaster to attend the dedication of the new home. The Kirk Johnson Co. will, during the month of December, combine with the J. H. Troup Co. in the exploitation of the Brunswick, featuring a joint advertising campaign for the holidays in the local newspapers.

Southern Dealers Add Val Phonic Line

Manufacturers in the Southern States have been so gratified with the preliminary tryouts of the newest of additions to the line of the J. A. Fischer Co., 730 Market street, that they have decided to add the Val Phonic reproducer as a permanent feature to the various makes of talking machines produced in that field. The tour of the trade in the South during the past month made by Julius A. Fischer brought about the line-up of many new patrons for the Val-Phonic reproducers. The factory here has been urgently in need of increased production to



GUARANTEE PORTABLE

Furnished in

**COBRA GRAIN BLACK
CROCODILE BLACK
CROCODILE BROWN
SPANISH BLUE**

SPECIFICATIONS:

1. Textene Leather Case.
2. Standard Helmsman Motor.
3. Plays Two 10" Records.
4. Standard Taper Tone Arm.
5. Specially Loud Reproducer.
6. Device for Carrying Records.
7. Machine Will Play 12" Records.
8. Patented "Non-Spill" Needle Cup.
9. Size 14½" x 11½" x 7¾".
10. Weighs 13½ pounds.

Guarantee Special Portable

Retail for \$12.50

Write for Prices in Quantity



Costs you \$10.50

RETAILS FOR \$25.00

GUARANTEE TALKING MACHINE SUPPLY CO.

35 N. NINTH STREET

PHILADELPHIA, PA.

Write for our latest Main Spring Chart

meet the needs of the nation in these specialties, and with the Southern talking machine producers now among the firm's consumers of the Val Phonic it has been found necessary to operate on a night-and-day basis.

On January 1 the firm will bring out the new Val Phonic tone arm, of unique design and specially finished in antique effect to correspond with the Val Phonic reproducer. The dealers have been salvaging their losses on the old-type machines by use of the Val Phonic tone arm and the Val Phonic reproducer and in this way modernizing the old-type machines. There just has been issued by the Fischer Co. a new and handsomely compiled as well as serviceable Valley Forge Main-spring Chart, listing sixteen new sizes and completing an assortment of eighty new sizes now produced by the company in the Valley Forge line. Irvin Epstan, of the company,

who has been touring through the West, is to return to headquarters here in time for the Christmas holidays and all road salesmen also will be at headquarters here until after the New Year.

Jacob H. Keen Making Portables

Having a few months ago dissolved partnership with William Posner, of the Guarantee Talking Machine Supply Co., Jacob H. Keen is now engaged in business on his own account, with headquarters at 109 North Tenth street, as a manufacturer of the Keen portable talking machines, repair parts, etc. The Keen portable is being produced in ten colors of Keratol leather and has the Silent Motor and other high-grade equipment.

Strong Demand for Guarantee Portables

Four models of the Guarantee portables have been heavily in demand and the rush on these keeps factory headquarters of the Guarantee Talking Machine Supply Co. humming on a night-and-day basis of operation. The four models that now are most popular are the Keen Tone, Guarantee Special, Guarantee De Luxe and the Guarantee. They are now being shipped to Australia, Japan, Roumania, Dutch East Indies, South Africa, South America and all parts of the United States.

Tie-up With Popular Orchestra

The Philadelphia Victor Distributors, Inc., 835 Arch street, will tune in with the appearance of the Silvertown Cord Orchestra when it appears here at Keith's Theatre, January 3. The dealers will be furnished with display matter and announcements of the various records in the Victor list made by the Silvertown Orchestra and the Silver Masked Tenor.

Sales-building Record Windows

Walter Stainthorpe, who conducts a Victor store at 2073 Cheltenham avenue and one of the leaders in enterprising methods for the exploitation of these products in this city, developed an attractive and sales-pulling window during the month. He featured the Orthophonic records with a large sunburst made of the mammoth record for the center sun-piece and radiating rays of rainbow shades in streamers of crepe paper to which were attached the various recordings.

Novelty and originality were combined in the display of the "Shut Your Eyes Window,"

(Continued on page 92)

"Trilling & Montague, wholesale radio merchandisers, Philadelphia, are recognized as one of the few wholesalers actually giving dealers service with a capital 'S'."

A TALKING MACHINE PUBLICATION.

DISTRIBUTORS FOR

ZENITH
The **CREBE**

KOLSTER**CROSLLEY**

Acme Products
Amplion
Balkite
Brandes
Bremer-Tully
Bright Star Batteries
Burgess Batteries

Eagle Chargers
Exide Batteries
Farrand
General Radio Co.
Hartford Battery
Jewell Meters

Majestic Eliminators
Pacnet
RCA Radiotrons
REL Products
Silkvoice Speaker
Silver-Marshall
Sterling Meters

Tab Batteries
Timmons
Tower's Products
Western Electric
Weston
and many others

Write for our 1926-27 Catalog

TRILLING & MONTAGUE

WHOLESALE RADIO MERCHANDISERS

49 North Seventh Street "Grow With Us"

Philadelphia, Pa.

**Windsor Wall or Table
Type Cone Speaker
Amazes Radio World**

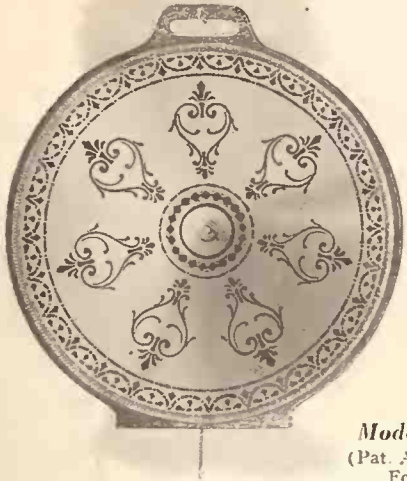

Model 210
(Pat. Applied For)

The latest model Windsor Cone Loudspeaker has astonished the world of radio. In convenience, quality of reception, and extremely low price, it far surpasses anything yet offered. The cone is 22 inches in diameter and is mounted on a sounding board which, in turn, is supported by an easel back. It can be hung up on the wall, as in the picture above, or stood upon any flat surface as shown in the picture below. It contains the famous Windsor loudspeaker unit noted for the extreme clarity and fidelity of reproduction.



Model 210
22-inch Cone Loudspeaker with sounding board and easel back.

\$15⁰⁰

(West of Rockies, \$18)
(Pat. Applied For)

**Model 302 (Shown below)
With Moulded Composition Horn Loudspeaker and 18-inch Cone Loudspeaker.**

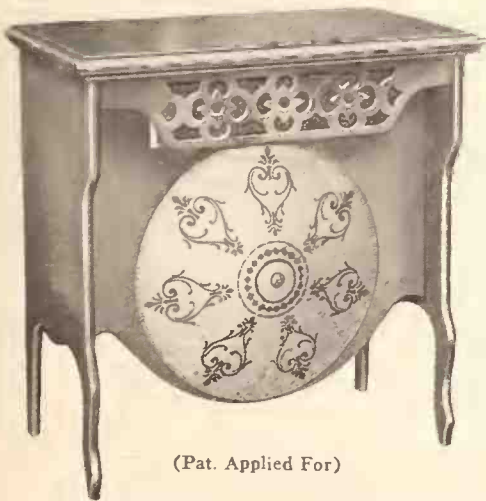

(Pat. Applied For)

In this Windsor Console are combined both the Windsor Moulded Composition Horn Loudspeaker and the 18-in. Windsor Cone Loudspeaker. The top is 30 in. x 17 in. and stands 29 in. high. Plenty of battery and equipment space is provided by large shelf in rear. Price, finished in Mahogany or Walnut,.....

\$48⁰⁰

(West of Rockies, \$55)

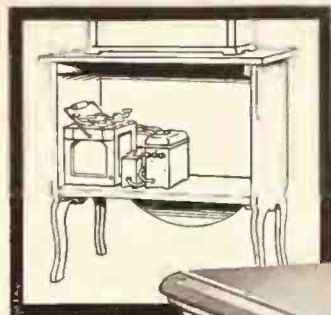

Rear view at left shows large compartment with ample space for batteries, battery charger or battery eliminator, which are entirely concealed from view. Back is open for ventilation of batteries.

At right is shown the Cone Loudspeaker, with its sounding board, which is quickly and easily removable, allowing instant access to all batteries, battery charger, battery eliminator or other equipment and wiring.



(Pat. Applied For)

Model 200—with 22-inch Cone Loudspeaker

This Windsor Cone Loudspeaker Console is equipped with a 22-inch Windsor Cone Loudspeaker. Its top is 30" x 17" and is 29" high. The battery shelf provides ample space for batteries, charger, battery eliminator and other equipment. Beautifully finished in either Mahogany or Walnut.

Model 200

\$29

Console with Cone Loudspeaker Ready for Set and Batteries

(West of Rockies, \$35)

This is the Fastest Selling Line of Loudspeakers and Loudspeaker Consoles in the Radio World Today



Model 100
with Moulded Composition Horn Loudspeaker or 16-inch Cone Loudspeaker
(Pat. Nov. 18, 1924)

Above is shown a beautiful Windsor Loudspeaker Console, finished in either Walnut or Mahogany, which provides ample space on top for any radio set. The battery shelf beneath will accommodate all necessary equipment. Equipped with either Moulded Composition Horn or 16-inch Cone Loudspeaker. Size: 38 in. x 18 in., and 29 in. high. Price.....

\$40⁰⁰

(West of Rockies, \$42.50)

To the right is shown the newest Windsor Loudspeaker Console. It is equipped with a 22-inch Cone Loudspeaker and cabinet suitable for 7-inch radio panels up to 26 inches in length. Battery shelf provides ample space for all equipment. Beautifully finished in either Walnut or Mahogany. Price (without receiving set)

\$44⁰⁰

(West of Rockies, \$52.00)



(Pat. Applied For)
Model 1000
with 22-inch Cone Loudspeaker

The quality of radio reception made possible by Windsor Cone and Horn Loudspeakers and Loudspeaker Consoles so far surpasses anything heard heretofore that it amazes and delights every radio enthusiast. The Windsor Line is so complete that everyone can find in it a loudspeaker, loudspeaker table, or loudspeaker console exactly to fit their particular needs.

Note to Dealers: Write or wire today for details of the highly profitable Windsor line.

Electrical Department

WINDSOR FURNITURE COMPANY

1426 Carroll Avenue - CHICAGO, ILLINOIS

... Las Angeles Branch—917 Maple Avenue

THE TRADE IN PHILADELPHIA AND LOCALITY—(Continued from page 90)

which gave prominence to the Victor records during the month in the store of J. Ralph Wilson. "Shut Your Eyes and Imagine the Artists Themselves Are Playing for You," says a banner strung across the window, while a huge face with prominent eyes made up the centerpiece on either side of which were the Orthophonic machines.

News Gleanings

Miss Freda Anker, head of the record department at the Gimbel Bros. department store, is being extended the sympathy of the trade upon the passing of her mother, whose death occurred November 3.

The store formerly occupied by Ertelts at 5617 North Fifth street now is owned by Harvey Hortman, for many years associated with the sales staff of the Victor Co., Camden. Since taking over the Ertelts store the place has been remodeled and modernized.

When Santa Claus made his daily visit to the auditorium of the new branch addition of the Gimbel Bros. store, where the toys were on display, the children visitors were greeted by echoes from the Juvenile Song list of the Victor Co. The Victrola will be used for concerts in the auditorium from time to time by the Gimbel store and has been installed as a permanent feature in the hall for entertainments and special events.

Miss M. Lennon, who formerly was with Ertelts, is now associated with the record department of the F. A. North Co., 1306 Chestnut street, having succeeded Miss Mary Mulqueen, resigned.

F. J. Heppe Convalescent

Trade sympathy was extended to Florence J. Heppe, head of C. J. Heppe & Son, 1115 Chestnut street, who during the month was confined to the Jefferson Hospital suffering from an acute attack of indigestion. In the early days of December the hospital reported President Heppe as on the road to recovery, with prospects of removal to his home in mid-December, where he will remain until sufficiently recuperated to resume his duties as head of the firm.

Stages Formal Opening

Philadelphia friends and associates of the Spangle Music House, of Harrisburg, Pa., journeyed to the Capital City during the month to join in the opening ceremonies of the remodeled and modernized home at 2112 North Sixth street.



3 1/2 inches diameter—Patented 1922.

It Pays to Add Deeds to Words
This Helps to Break Down Sales Resistance

Word advertising helps business, of course, but being helpful is more effective. The OFFER of a

VELVALOID RECORD BRUSH

will bring people to your store, and your message is permanently delivered to them.

Dealer's ad beautifully imprinted on Pyralin top. Pyle plush cleaning surface in assorted shades.

We know it pays. Let us tell you how and why, then we are sure you will order VELVALOIDS thru your Jobber.

PHILADELPHIA BADGE CO.
MANUFACTURERS

942 Market Street Philadelphia, U. S. A.

Victor Car Advertising to
Reach 40,000,000 Riders

Considered One of Most Extensive Street Car Advertising Campaigns Sponsored by Any National Advertiser in Recent Years

It was announced recently in various advertising publications that the Victor Talking Machine Co. had completed arrangements for



One of the Victor Car Cards

one of the most important and extensive street car advertising campaigns that have been sponsored by any national advertiser in recent years. The Street Railway Advertising Co. carried double pages in various magazines advising the advertising fraternity that Victor car cards would reach 40,000,000 daily riders in the street cars of the United States with a card in every car on the company's entire list. This gives an idea of the magnitude of the campaign, which is merely a part of the Victor Co.'s consumer advertising.

The list of railways whose advertising is controlled by this concern covers cities and towns in the United States from the Atlantic to the Pacific and from Canada to the Gulf. Several very attractive car cards featuring Victor Orthophonic products have already been

prepared and one of these cards is shown in the accompanying illustration. The cards are designed in several colors and will form an important link in the 1927 Victor publicity campaign.

Sonora and Sparton Lines
Shown in Fine Setting

Quality Furniture Co., Joliet, Ill., Drew Attention to the Products It Handles by an Attractive Display at Radio Show

A setting of refinement was the keynote in the display of the Quality Furniture Co., Joliet, Ill., at the Joliet Radio Show, held recently, where the phonograph and radio products of the Sonora Phonograph Co. were exhibited, together with radio receivers manufactured by the Sparks-Withington Co., of Jackson, Mich. Softly shaded lights, tapestry furniture, flowers and ferns served to lend an atmosphere which attracted the radio show visitor and displayed the merchandise to the best advantage. The Quality Furniture Co.

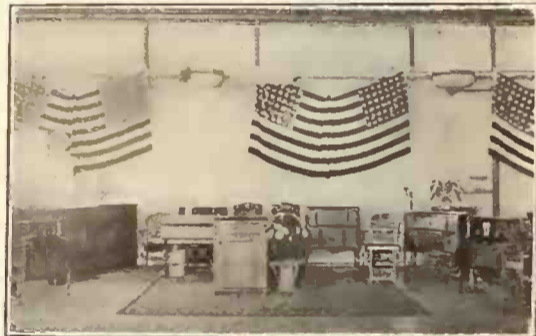

Fine Exhibit of Sonora and Sparton Lines added the Sonora line in August and has made an enviable record in radio merchandising in its city during the past few months.

Emphasizes Need of Right
Batteries With Power Tubes

Pointing out that power tubes are power handlers, not power producers, the National Carbon Co., manufacturer of Eveready batteries, stresses the necessity for the use of the proper battery in connection with the new power tubes. It is stated that power tubes consume more B battery current and they require greater C battery voltage. Officials of the National Carbon Co. said that the Eveready Heavy Duty B battery is particularly well equipped to give the extra power handled by power tubes and should be used in preference to light duty batteries. It is said that dealers will insure better customer satisfaction in specifying the Heavy Duty battery wherever power tubes are used.

Fada Issues New Booklet

An attractive booklet on harmonated reception has been issued by F. A. D. Andrea, Inc., New York, to Fada dealers for distribution to the public. It is written in a non-technical manner and features the Fada line, with particular attention to the Fada eight-tube and six-tube models and the Fada cone speaker.

To Our Victor Dealers

IN token of our appreciation of your friendship, your confidence and your loyalty we extend to you our sincere wish that you may enjoy a truly Happy Christmas Season and a most Prosperous New Year.

H.A.WEYMANN & SON, INC.
1108 Chestnut Street - Philadelphia, Pa.

Burtex
TRADE MARK

Stevens diaphragms are made of "Burtex"—the new scientific material which makes possible the *only* seamless diaphragm on the market.

It is a fabric base, formed under tension into the "conoidal" form of continuous curves, for maximum resilience and resonance.

Furthermore it is scientifically and chemically impregnated so that it is absolutely damp-proof even under the most trying atmospheric conditions.

The Stevens diaphragm is practically unbreakable and is quickly replaceable if damaged.

That's a Stevens!

Stevens quality is instantly recognized by eye and ear.

Stevens Speakers sell best in competition—they challenge comparison with all others—and they win!

Give your customers an opportunity to hear Stevens Speakers—show them the decorative qualities of these wonderful musical instruments—and the sale is made.

Stevens Speakers cut your selling costs and increase your turnover profits. This is not mere theory—hundreds of enthusiastic dealers are doing it right now.

Are you sharing in this success?



Model "A" 17½ inches
Ideal for the home, combining superior tone and volume with decorative elegance. Mahogany sounding board gives rich resonance and power to the tone. Can be used on console, or hung on wall. Complete with easel base and silk hanging cord. \$25

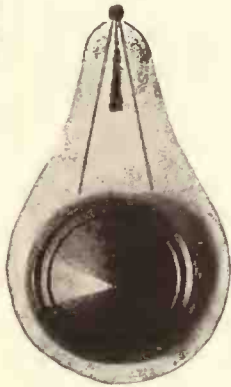

Model "B" 14½ inches
Similar to Model "A" but smaller. Has Burtex diaphragm, resonant wood sounding board, and powerful balanced armature unit, giving remarkable volume with highest tone quality. Ideal for a small room. Finished in rich, mahogany shades to match many of the standard sets. Price\$16.50



Licensed and Manufactured under Pat. No. 1414801

The Famous Stevens "TT" Balanced Armature Unit

Another unique feature is the Stevens "TT" unit—the only unit built on the tensile tension principle developed by years of experiment and test. The armature is fastened at both ends and is perfectly balanced between the pole pieces. Being under tension, this absolutely eliminates "freezing" to the pole pieces—a common trouble with the ordinary unit. Furthermore, the coil winding is synchronized with the tension so that even excessive current will not disturb the quality of reproduction. Each unit is carefully adjusted at the factory and needs no further adjustment for any kind of a receiving set.

CONOIDAL
CONTINUOUSLY CURVED
The scientific curve of perfect sound reproduction

Great Combination Offer

When you handle Stevens Speakers you have the advantage of a great combination—superior product and real, honest-to-goodness dealer and jobber co-operation.

Stevens Speakers are made and sold *right*, and are backed by dealer helps, publicity, national advertising, and local advertising in conjunction with distributors.

Stevens dealers are enthusiastic. You, too, can share in the profits of this fast selling line. Write to-day for full details.

Stevens Speakers

STEVENS & CO., Inc. 46-48 E. Houston St., N Y.

Made by the Pioneers of Cone Speakers

Christmas profits for you— sell TUNGARS

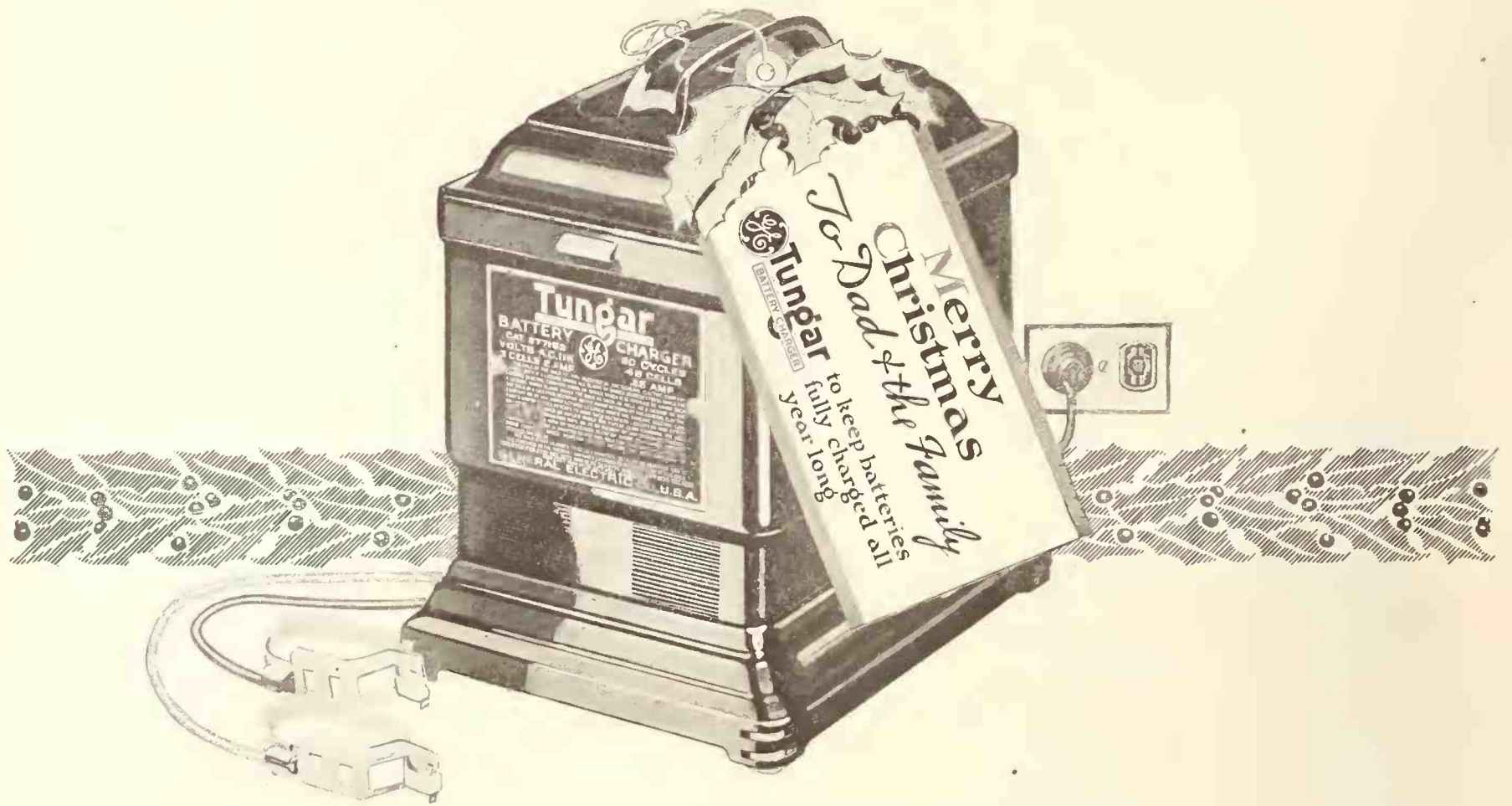

The increase in sales of Tungar Battery Chargers at Christmas time for the past few years proves conclusively that they are ideal gifts.

They are welcomed because they bring with them assurance of full power for radio sets—for years to come. And they also promise the motorist no run down starting battery. So Tungar is a two-fold gift—and therefore twice as easy to sell.

Tie-in with our Christmas national advertising. Dress your window and showcase by displaying Tungars and using the specially designed Christmas tag.

List Prices

(East of the Rockies)

2 ampere Tungar	\$18
5 ampere Tungar	\$28
Trickle Charger	\$12
(60 cycles—110 volts)	



Tungar

REG. U.S. PAT. OFF.

BATTERY CHARGER

Tungar—a registered trademark—is found only on the genuine. Look for it on the name plate.

GENERAL ELECTRIC

GENERAL ELECTRIC COMPANY

MERCHANDISE DEPARTMENT

BRIDGEPORT, CONNECTICUT

Caswell

Sends a Christmas message of appreciation and good will to dealers, jobbers and associate manufacturers. The support and patronage of our dealers and jobbers has been the outstanding feature of the portable phonograph industry the past year, and in return we extend sincere wishes to all members of the trade for a year of prosperity.

Caswell Manufacturing Co.

PORTABLE PHONOGRAPHS OF DISTINCTION

MILWAUKEE, WIS.
U.S.A.



ST. PAUL AVE.
AT 10TH STREET

Dealers View Grimes-Viking Radio at Dinner

David Grimes, Inc., Manufacturer of the "Viking" Radio Line, and Radio Circular Co. Hosts to Dealers in New York

David Grimes, Inc., 151 Bay street, Jersey City, N. J., manufacturer of the Grimes radio



Dealers Present at David Grimes-Viking Dinner

receivers now marketed under the trade name "Viking," recently held a dinner for its metropolitan dealers at the Hotel Pennsylvania, New York City. Following the dinner a demonstration of the new Viking models was given. These new receivers are now being delivered to the trade in quantities and incorporate some of the very latest developments and perfections of the David Grimes, Inc., engineering staff.

The dinner was given under the auspices of both David Grimes, Inc., and the Radio Circular Co., distributor in New York and surrounding territory, of which Mac Levy is the head. Mr. Levy, who is well known in retail trade circles, was paid a warm tribute by those who attended the dinner.

Lee Brown, of Picard, Bradner & Brown, the advertising agency handling the David Grimes, Inc., account, acted as chairman for the

dinner and introduced the various speakers. The talks were quite short and the evening was given over mostly to demonstrations of the Viking receivers.

The receivers shown were the Viking Imperial in both table and console and the Viking Standard in table model. The sets performed excellently and brought forth particular comment upon the quality of tone. Stress was laid by the speakers upon the durability of the workmanship and the elimination of service following sales.

Representatives of the Grimes organization present were R. Lowie, James F. Bell, Frank E. Burdette and A. E. Kraft.

The dealers who were present at the demonstration were unanimous in their conviction that the

new Viking models will find a ready and hearty reception from the radio-buying public.

Silent Motor Corp. Makes New Double Spring Motor

A new double spring motor, Model DS, which will play approximately five phonograph records, will shortly be announced to the trade by Herman Segal, president of the Silent Motor Corp. This new motor will incorporate all the features which have won recognition for the well-known Silent motor. Mr. Segal states that samples are ready, and that he is prepared to quote attractive prices on quantity orders to manufacturers. The Silent motor factory in Brooklyn, N. Y., has gone into production on the new motor, and preliminary conferences

with leading phonograph manufacturers lead Mr. Segal to believe that it will be necessary to increase the Silent motor manufacturing facilities at an early date.

The Silent motor line now comprises two models of double-spring motors and one single-spring model.

R. K. Kind Is Appointed Thorens General Manager

New Executive Will Make Headquarters in New York—Was Formerly Connected With Thorens Plant at Ste. Croix, Switzerland

The formation of Thorens, Inc., a new corporation which will handle the well-known Thorens line of Swiss phonograph motors and musical goods in the United States, was announced by Frederic Hermann Thorens, prior to his sailing for Switzerland on December 15. Mr. Thorens has been in the United States for several months reorganizing the firm's interests here, made necessary by the recent death of Louis Henry Junod, who represented the Thorens line of motors and other products in the United States for many years.

Simultaneously, Mr. Thorens announced the appointment of R. K. Kind as general manager of Thorens, Inc. Mr. Kind, who will make his headquarters at the company's offices in New York, was formerly connected with the Thorens works at Ste. Croix, Switzerland, where he gained a thorough knowledge of the line. Recently Mr. Kind was general manager of the Joseph Schlitz Beverage Co. Thorens, Inc., will handle in the United States all products manufactured by the Swiss firm, including cigar lighters and other novelties.

A repair parts department will be maintained by Thorens, Inc., at New York for the convenience of the trade.

The Euphonic

—an instrument of distinction

1927 will be a great year for Euphonic Dealers

Christmas Greetings

In extending Yuletide greetings to the phonograph industry, we must express our deep appreciation of the recognition afforded Euphonic products.

It will be our privilege to co-operate with representative music merchants in making 1927 a year of profit and satisfaction.

WASMUTH-GOODRICH CO.
Manufacturers of Phonographs and Radio Cabinets
Peru, Indiana

New Stores and Changes Among Talking Machine Dealers During the Past Month

New Stores Opened Recently Throughout Country and Changes of Management Compiled for Benefit of Talking Machine and Radio Manufacturers and Distributors

Alabama

Ensley—The Manning Music House has been established here at 714 Nineteenth street. M. D. Manning, formerly with Ludden & Bates, of Savannah, Ga., is proprietor.

Arkansas

Van Buren—A new music store has been opened here by Ed. Overby and Willard McBride.

Heber Springs—P. Weatherman has opened a music store in the Skelton building, carrying a complete line of musical instruments.

California

San Diego—The San Diego Music Co. was recently chartered by C. E. Butler, John Buckro and T. F. Sibley.

San Francisco—Walter Wiggins, who operates the Sunset Music Store, has moved to a new location and has added to the lines carried.

San Francisco—H. W. Mitchell has purchased the stock and business of W. Statham, music dealer, at 24 Hill street.

Sacramento—The local branch of the Hauschildt Music House has been closed out and the company will concentrate on the Oakland store.

Hollywood—A branch music store will shortly be opened at 6776 Hollywood Boulevard by Barker Bros., Los Angeles.

Colorado

Monte Vista—The Charles E. Wells Music Co., Denver, has opened a branch store in the Cramer Building with Andrew J. Speich as manager.

Connecticut

Meriden—The Gibbs Piano Co. has opened a branch store at 88 West Main street here under the man-

agement of J. C. Lavinnanna. A full line of musical instruments is carried.

Thompsonville—The Music Lovers' Shop, which also conducts a branch at Windsor Locks, has filed a petition in bankruptcy with assets of \$4,600 and liabilities of \$14,403.

New Haven—The A. B. Clinton Co., which has been located for several years at 33 Church street, has moved to new quarters at 942 Chapel street, in the heart of the business district.

Delaware

Wilmington—A charter has been granted to Charles A. Brozek, who will deal in musical instruments with a capital stock of \$100,000.

Florida

Miami—The Chalmers Music Co. has moved into new quarters at 62 West Flagler street.

Miami—The Johnson Music Co. has opened a "Serv-U-Self" music and radio store at 14 West Flagler street.

Gainesville—C. A. Powers has taken over the talking machine and music department of the Gainesville Furniture Co.

Ocala—George MacKay & Co., furniture dealers, recently added a talking machine section carrying a full line of Brunswick Panatropes, phonographs and records.

Georgia

Atlanta—The Clarke-Atlanta Music Co., which for the past ten years was located at 58 Auburn avenue, is now settled in its new quarters at 45 Auburn avenue.

Savannah—The B. J. Sheppard Co., music dealer, has moved to more handsome and considerably larger

new quarters at 220 Broughton street, West.

Illinois

Peoria—The Lacey Music Co. has been incorporated with a capital stock of \$12,000 by John M. Niehaus and Martha Meyer.

Danville—The Benjamin Temple of Music, 30-32 North Vermillion street, has been purchased by the Person Piano Co., of Indianapolis, and C. H. Meredith has been made manager.

Bloomington—A. C. Emons has opened a complete music store on West Locust street.

Rockford—L. E. Ware has been appointed manager of the Haddorff Music House, 220 North Main street, succeeding D. Dickerson, who has resigned.

Chicago—A charter has been granted to Rubank, Inc., 322 West Congress street, to deal in musical instruments.

La Salle—The Groves Music Shop, which has been doing business in Bent's Furniture Store, has taken new quarters two doors west of the present location.

Chicago—A charter has been granted to the Interstate Music Co., 525 Judson avenue, to conduct a general music business with a capital of \$20,000.

Chicago—The Rosenthal Music Shop, 1104 South Halsted street, was recently incorporated with a capital stock of \$2,000.

Rockford—A stock of phonographs of the Williams Sport Shop has been acquired by Fred E. Ramer, 318½ Chestnut street.

Arcola—Everett Henne has opened a new music store here.

Indiana

Connersville—Russell Davis is continuing the music business formerly conducted by J. R. Burke.

Marion—The Marion Piano Co. has been incorporated to deal in musical instruments with a capital stock of 1,000 shares of no par value.

Bloomington—The Owens Music Co. is completing removal of its stock from Spencer to attractive quarters here.

South Bend—T. H. Mains is preparing to move his music store from 107 West Division street to new quarters at 207 West Jefferson Boulevard.

Kansas

Liberal—S. J. Warlick recently opened a new music store, carrying a complete line of instruments.

Kentucky

Ashland—Scott Bros., music dealers, plan moving to a new location in the near future.

Maine

Millinocket—Whalen's, Inc., has taken over a music store and will carry talking machines and other musical instruments.

Massachusetts

Springfield—The music store of Forbes & Wallace on Federal street, will soon move to a new location in the Lawler building.

Boston—The Parkman Piano Co. was recently incorporated with a capital stock of \$100,000 to deal in musical instruments.

Michigan

Detroit—Grinnell Bros. have taken a lease on the property at 1514 Broadway and will open a branch store at that address as soon as necessary alterations are completed.

Alpena—Additional space on the second floor of its building has been obtained by the Howe Music Store, Second avenue and Water street.

Minnesota

Rochester—The Lindsey-Bach Piano Co. has purchased the stock and fixtures of a store in the Lawler Theater building and will operate a general music store there.

Minneapolis—The Radio & Victrola Shop, formerly located at 318 West Broadway, has opened a new store at 314 West Broadway.

Minneapolis—The Boland Co., carrying a full line of musical instruments, has moved to new quarters at 19 South Eighth street.

Missouri

Centralia—M. L. Pruitt suffered considerable damage to his stock from a fire of unknown origin.

St. Louis—A talking machine department is being added by Conroy's Piano Co., 1100 Olive street.

New York

Albany—The Baker Music House has established a branch store at 97 North Pearl street.

Oswego—Stephen C. Healy has purchased a controlling interest in the Burke Music Co., and will conduct the business under the name of the Stephen C. Healy Music Co.

Newburgh—Harvey Morse has purchased his partner's interest in the music business of Buerger & Morse.

Depew—The Depew Music Store has opened at 61 Main street with a complete line of musical instruments.

New York—The Greek Music Co., 616 Elghth avenue, has taken over the adjoining store to care for the growing business.

New York—Marconi's Music & Radio Store will move shortly to 1932 Third avenue.

Saranac Lake—The music store of Henry P. Leis at 3-5 Bloomingdale avenue, which was gutted by fire some months ago, has been renovated and enlarged and has re-opened for business.

Olean—Charles E. Edel has purchased the entire business of the firm of Edel & Thompson and is continuing the business under the name of the Edel

(Continued on page 98)



Mohawk Corporation of Illinois

Independently organized in 1924

MANUFACTURERS OF
RADIO APPARATUS - BRASS SPECIALTIES
ELECTRICAL FITTINGS

MOHAWK BUILDING
DIVERSEY AT LOGAN BOULEVARD
CHICAGO, ILLINOIS

November 11th,
1926

PRODUCTS OF
QUALITY

Talking Machine World,
383 Madison Avenue,
New York City.

Dear Sirs:

Attention - Mr. Lee Robinson

A job well done is its own reward, but a job so well done that it creates complete recognition from an entire industry merits commendation and acknowledgment. This commendation and acknowledgment is hereby conveyed to you wholeheartedly.

The writer's experience, covering a quarter of a century in the advertising field, justifies him in telling you that never before has such splendid, wholehearted, and unselfish cooperation been rendered by any publication, as was given us in connection with the eighteen-page Mohawk Radio insert, which appeared in the October 15th, 1926 issue of the "Talking Machine World".

Every detail in the securing of the several page advertisements from our several distributors, all correspondence in connection with it, the handling of art work, plates, type-setting - with one word, the whole job was admirably executed. Not to acknowledge this splendid cooperation which you gave us would be, indeed, withholding from you well deserved praise.

In closing, no small amount of credit for the splendid work in connection with this insert should be given your untiring Chicago representative and worker, Mr. L. P. Canty.

It will be our pleasure to continue our pleasant and profitable association with you for many years to come.

Most cordially yours,

MOHAWK CORPORATION OF ILLINOIS.

Otto N. Frankfort
General Sales Manager

Otto N. Frankfort:HG

Just ONE Dial
to tune

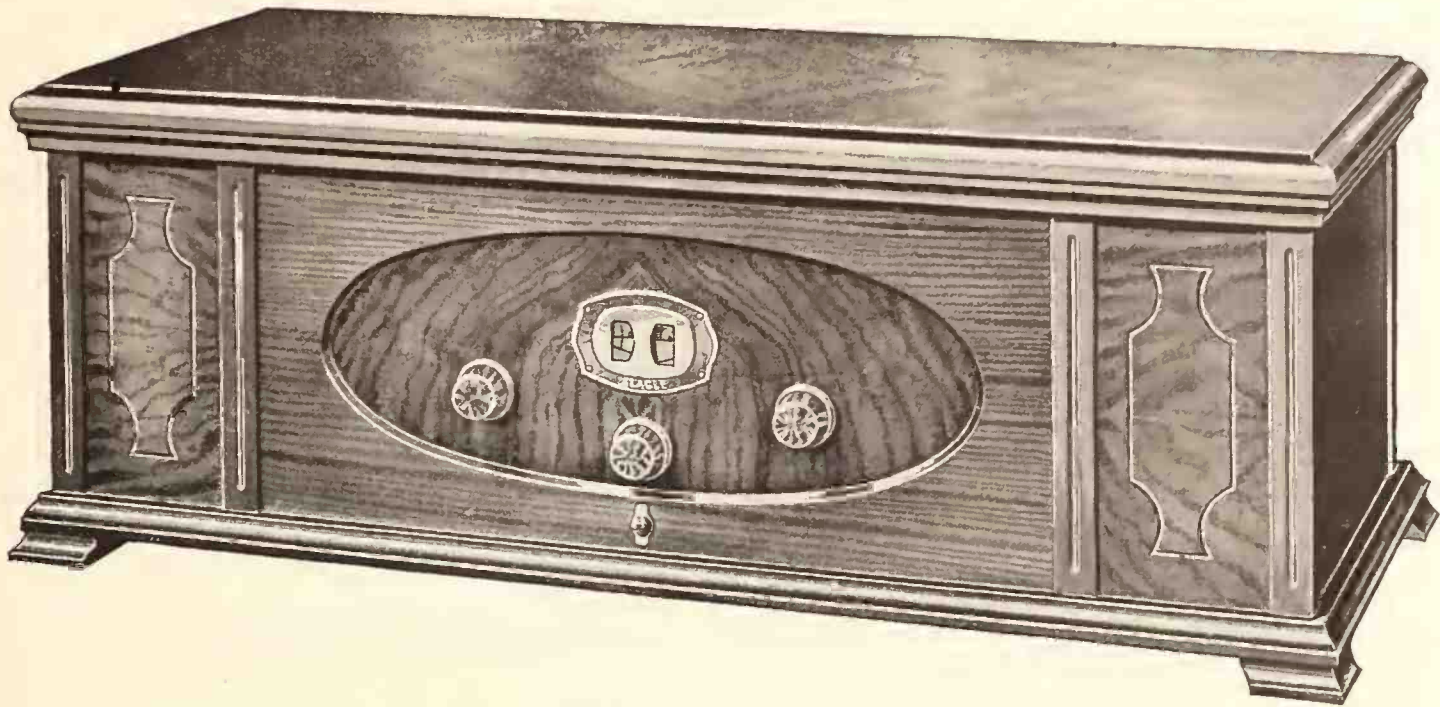

Making Radio History

THE Slagle 2-dial control line of receivers is an outstanding success. All working units are completely protected from each other and the outside by cast-aluminum shielding.

The finest achievement of over 15 years of building high quality radio sets, you will find them a genuine pleasure to sell. The value is there—prices low for the quality. The performance is as nearly perfect as a set has given to date. The owner gets an ever increasing amount of pleasure and satisfaction from his purchase.

That's a combination that builds profitable business for you and for us through you. Let us tell you more about it.

SLAGLE RADIO COMPANY
Fort Wayne, Indiana

 Slagle Radio

We Extend Our Sincerest Wishes
to all our friends for
A Merry Christmas and
A Very Happy and Prosperous New Year

SUPERIOR PHONO-PARTS CO.

799 Broadway, New York City

Factory: NEWARK, N. J.

New Stores and Trade Changes of the Month

(Continued from page 96)

Musical Co., located at 1206 Irving street here.

Brooklyn—A charter has been granted to Baim & Blank to deal in musical instruments with a capital stock of \$11,000.

Patchogue, L. I.—Smith & Lull, of Bay Shore, have opened a branch store in the Shand Building on West Main street, this city.

Queens, L. I.—A petition in bankruptcy has been filed by Robert Goodman, music dealer, 220-09 Jamaica avenue, listing assets of \$2,537 and liabilities of \$4,927.

New York—The music department of Gimbel Bros. has been moved from the eighth floor of the department store to the ground floor and basement of the Cuyler Building, 122 West Thirty-second street.

Buffalo—Howard Weber has been made manager of the Robert L. Loud Music House.

Brooklyn—C. Bauer Sons, Inc., recently added a talking machine department carrying the complete Victor line.

Rockville Center, L. I.—A. E. Henderson has purchased the stock and business of the Montauk Music Shop and is continuing the business under the same name, carrying the Victor line.

Brooklyn—L. J. Sattler was recently appointed manager of the music store of Albert Bersib, 1253 Bedford avenue.

New York—Galbraith Perry has assumed the management of the West End Radio Shop.

Easthampton, L. I.—A new music store, the Easthampton Music Shop, carrying the Victor line, was opened recently in the Edwards theater building by Louis Davidow and Al. Dundon.

North Dakota

Bismarck—The Capital City Piano Co., of which J. C. Madden is proprietor, recently opened a store here, carrying a full line of talking machines, pianos and band instruments.

Ohio

Akron—The A. E. Jones Music Co. recently opened a store on East Market street.

Willoughby—The Willoughby Music Co., has been incorporated for \$15,000 by R. A. and R. I. Semrad, A. T. Madow, C. A. Reeves and J. A. Bechtol.

Youngstown—The Strauss-Hirshberg Co., department store, with a complete music section, recently moved into its new six-story building.

Cleveland—J. Zarworski has opened a music store in the Alliance of Poles building carrying a full line of instruments.

Toledo—The Whitney, Blaine, Wildermuth Co. has moved into a new building, which provides more space for demonstration and display of the lines of instruments carried.

Akron—Mrs. W. H. Stowe recently opened a music store at 123 South Main street, carrying a full line of instruments.

Bellefontaine—J. O. Smucker, who operates a music store here, is planning to open a branch at Urbana.

Springfield—Earle K. Hawken & Sons opened their new music store at 19 North Fountain avenue recently with appropriate ceremonies, including a store concert by two orchestras.

Zanesville—The stock and fixtures of the Longshore Music Co., North Fifth street, have been purchased by the Spence Music Co., of North Fourth street.

Akron—The Saxophone Shop, carrying the complete King line of band instruments, has recently been opened as a division of the A. B. Smith Piano Co.

Cleveland—The Miltner Piano Co. has opened its remodeled warerooms at 5841 Broadway, featuring the Brunswick Panatope, pianos, small goods and sheet music.

Cleveland—Jerry Fraiberg has opened a music and jewelry store at East Fifty-fifth street and Broadway.

Crestline—Fred C. Kloepper, music dealer of Bucyrus, is opening a branch store here.

Oklahoma

Cordell—A new music store has been opened here by the J. E. Bennett Music Co., featuring the Zenith line of radios and Gulbransen pianos.

Altus—The Culp Piano Co. has leased a building here for the purpose of installing a branch store which will be under the management of Y. H. Nunn.

Oregon

Portland—Allen McLean, formerly manager of the talking machine department of the Hyatt Music Co., has assumed the management of the phonograph department of the Seiberling Lucas Music Co.

Portland—C. H. Heim has been appointed manager of the new branch of the Hyatt Music Co., which will open shortly in the Hollywood theater building.

Astoria—The Bee Hive department store has opened a music department carrying a full line of instruments. H. H. Princehouse is manager.

Pennsylvania

Huntington—W. W. Staylor, music dealer of this city, has purchased property in Mt. Union, Pa., with a view to building a music store on the site.

Somerset—The stock and interests of the Collins Music Store have been purchased by E. A. Ferguson.

Harrisburg—The new home of the Spangler Music House was opened last month with appropriate ceremonies.

Williamsport—The Hartman Furniture Co., 330 West Fourth street, has taken over an adjoining store and has added a line of musical instruments and radio receivers.

Kutztown—Byron A. Stein, who carries a line of talking machines, will move to larger quarters at 221 Main street in the near future.

Finleyville—The Schroeder Piano Co., has opened new warerooms in the Shepler building with J. T. Smith as manager.

Tennessee

Nashville—Allan Welburn, formerly with the O. K. Houck Piano Co., has been appointed manager of the Claude P. Street Piano Co.

Five Points—A new music store operated by the Price Music Co., was recently opened in the Bandy-Price building on Charlemont street. A complete line of instruments is carried.

Texas

Galveston—The Galveston Piano Co., carrying a full line of musical instruments, recently celebrated the opening of its new quarters at 2015 Market street.

San Antonio—J. L. Norris has been appointed manager of the new store of the A. F. Beyer Co.

Mission—G. H. Jackson and J. L. Miller are preparing to open a music store here.

Groveton—A large stock of merchandise, including talking machines was destroyed by fire recently in the store of the Trevethan & Reily Co.

Utah

Ogden—A branch of the Beesley Music Co. of Salt Lake City, has been opened in the department store of W. H. Wright & Sons Co., Washington avenue, with A. L. Card as manager.

Washington

Vancouver—Suitable quarters for a music store have been obtained by James Waggener, Jr., in the New Central building, 1200 Main street.

West Virginia

Charleston—The Galperin Music Co. recently held a formal opening of its new store at 15-17 Capitol street.

Rowlesburg—Mrs. A. F. Cheney is the proprietress of a music store which opened here recently.

Wisconsin

Cumberland—The Manhart Music House has moved to larger quarters in the Zimmerman building.

Tomahawk—Theodore Doucette has opened a music store in the Lyric theater building.

Baraboo—Willey's Music House was recently purchased by Ted J. Holzem, formerly district representative of the Gulbransen Co.

Sunnyside—The Talcott Music Store was recently opened here with fitting ceremonies.

Royalty of Roumania Use
the Bell & Howell Camera

Camera Has Won World-wide Fame as Shown
in Accompanying Photograph of Queen Marie
Using the Bell & Howell on Palace Grounds

The world-wide fame of the Bell & Howell camera product, which now includes the popu-



Bell & Howell Camera Used by Queen Marie of Roumania. The large automatic Filmo for individual use, is emphasized in the accompanying photograph showing Queen Marie of Roumania on the royal palace grounds. Queen Marie was snapped as she was learning the distinctive features of the Bell & Howell standard professional camera which she greatly prizes.

Here's What Landay Bros. Say of



KELLOGG Radio

Flawless Reproduction.

Inductive Tuning, a new and exclusive Kellogg development, has brought to Radio a greater simplicity of operation. Stations are spread out on the station selector seven times farther apart than heretofore. For the first time, also, equal efficiency is had at all wave lengths.

Sherman, Clay & Co.

on the Coast, Present

KELLOGG Radio

Flawless Reproduction.

In the console model there is a built-in speaker made of a new material and so designed as to give a far more even amplification of all musical notes. Either the table or the console models can be fitted with A and B power units for operation from the electric light socket.



Grinnell Bros. Enthusiastically Endorse



KELLOGG Radio

Flawless Reproduction.

Desirable territories are still open and dealers are cordially invited to write in for complete details on these advanced receivers and full information on the Kellogg franchise. Kellogg Radio is a line of fine musical instruments well suited to music dealers.

Kellogg Switchboard & Supply Co.
1066 West Adams St., CHICAGO



We bid you a Merrie Christmas

“To the Heavens above us
Oh, look and behold
The planets that love us
All harnessed in gold!
What chariots, what horses
Against us shall bide
While the Stars in their courses
Do fight on our side?”

Christmas 1926

Consolidated Talking Machine Co.

Distributors of Okeh-Odeon Records

227 W. Washington Street

Chicago, Illinois

Branches: 2957 Gratiot Ave., Detroit, Mich. : 1424 Washington Ave., Minneapolis, Minn.

From our **CHICAGO** HEADQUARTERS

REPUBLIC BLDG., 209 SOUTH STATE ST TELEPHONE WABASH 5242

LEONARD P. CANTY

Middle Western Retailers Take Advantage of Tie-Up Opportunities and Sales Gain

Shortage of Certain New Models, Especially Talking Machines, Is Reported—Entire Trade Prepared for the Expected Holiday Rush—News and Trade Activities of the Month

CHICAGO, ILL., December 8.—Distributors of and dealers in phonographs and radio receiving apparatus, generally, throughout the city of Chicago and surrounding territory, have experienced a slight lull in business during the past three or four weeks, although the first of December was looked upon by many trade authorities as the turning-point and the beginning of the actual holiday buying season. The lull in buying has, perhaps, been more noticeable in radio than in talking machines and records, since there is far more competition in the first named field, due to the fact that there are so many retail outlets for radio receiving apparatus of all kinds.

In the talking machine field a comparison with the corresponding period of last year shows that November, 1926, was ahead of the sales volume of the same month of 1925, for the new type phonographs and electrical reproducing instruments had barely been introduced at that time. However, the so-called pre-holiday slump is looked upon as only temporary, and is something which financial authorities and bankers agree occurs each year at this time in some degree.

In many cases, distributors and dealers have given an entirely different report, stating that they are experiencing trouble in obtaining a sufficient quantity of merchandise to meet the demand placed upon them. This is especially true in the talking machine field, where a number of manufacturers have only released a few machines and have not yet placed their plants on a full production basis. Many dealers are still receiving shipments placed on "back order," the machines being delivered to consumers who have been waiting for a certain model or cabinet design.

Dealers in this territory recently have had several exceptional opportunities for the exercise of sales promotional ability and those who have taken advantage of them through advertising and publicity have profited. The Army-Navy football game, from which thousands of disappointed fans were turned away because of the limited seating capacity, brought about the purchases of numerous receiving sets. Weeks in advance of the struggle dealers throughout the city had issued a note of warning through newspaper advertising and window displays, suggesting the delivery of a radio set to the home, where the family could listen to the game in comfort. Hundreds of installations were made both in the city and throughout the Middle West because of this one event and the fact that the dealers had grasped an unusual opportunity.

That interest in the talking machine and phonograph music is running high is shown by the steady increase in record sales. A gain over October sales is reported in the great majority of instances, with a greater increase expected during the next three weeks of holiday shopping. Local appearances in theatres by popular individual artists and recording orchestras have accomplished much in a promotional way, coupled with the advertising appearing in the daily newspapers, and the individual efforts of the retail merchants and their salespeople.

Auditorium Orthophonic Victrola Interests
Chicago music lovers have been given an op-

portunity to hear the Auditorium Orthophonic Victrola, an instrument of large size and tremendous power, during the past few weeks, as it has been demonstrated for some time at the Lyon & Healy concert hall and also in the Walnut Grill of Marshall Field & Co. Both Auditorium Orthophonic Victrolas,

now in Chicago for the holiday season, are identically the same as the one demonstrated at Atlantic City, N. J.

Marshall Field & Co., in introducing the Orthophonic Victrola recitals, held from two until five o'clock each afternoon, issued the following announcement: "Each business day a recital of miscellaneous musical numbers will be played in the Walnut Grill from two until five. This program will be changed daily. This huge instrument produces a vast volume of sound, and whisper-like tones are reproduced with great clarity. People have stood a mile

(Continued on page 102)

True Tone Reproduction KIMBALL PHONOGRAPH



The Latest
and Best

Style 300

SIZE:
45 inches high
32 inches wide
23½ inches deep

Quietness of Operation; Fidelity of Tone Reproduction, Therefore
Ideal for Home, School or Hall

Many Exclusive Features; Plays All Records

Hear it. Compare with others

Write or wire us for particulars

W. W. KIMBALL COMPANY

Established 1857

306 S. Wabash Ave., Kimball Bldg.

Chicago, Ill.

FROM OUR CHICAGO HEADQUARTERS—(Continued from page 101)

from it and heard distinctly its music and an audience of 200,000 recently listened to it without the means of amplifiers."

W. C. Fuhri Off to Pacific Coast

W. C. Fuhri, vice-president and general sales manager of the Columbia Phonograph Co., Inc., New York City, passed through Chicago late in November en route for the Pacific Coast. He spent some time with A. J. Heath, manager of the Columbia Chicago office, and expressed great satisfaction as to the volume of Columbia business now being secured throughout the country. He is expected to visit Minneapolis and Chicago on his return trip to the East.

The Chicago branch of the Columbia Phonograph Co., Inc., is now receiving more substantial shipments of the new Viva-tonal Columbia instruments than for some time past, according to A. J. Heath, manager. This is evidently pleasing to the management of the Chicago Columbia office, for it enables the local branch to fill many orders which have been on file for the past several weeks.

Otto Heineman Visits Chicago Trade

Otto Heineman, president and general manager of the Okeh Phonograph Corp., New York City, spent several days in Chicago visiting the local trade during the latter part of November. While in the city he called at the local Columbia office for a visit with District Manager A. J. Heath, who was indirectly associated with Mr. Heineman several years ago. Mr. Heineman visited the trade in St. Louis before returning to New York.

New Columbia Records Coming

Columbia dealers in Chicago and the Middle West territory may anticipate receiving, in the very near future, new Columbia records by their favorites, including Ted Lewis, Paul Ash, Ruth Etting, Ford and Glenn, Art Kahn, Al Handler and others, as a Columbia recording expedition spent several days in Chicago recently for the purpose of recording the many Columbia artists now in the city. J. S. MacDonald, assisted by Eddie King, gave his personal supervision to the recording of the new Columbia numbers.

Sampson Electric Co. to Distribute Radi-"A"

The Briggs & Stratton Corp., Milwaukee, Wis., recently appointed the Sampson Electric Co., Atwater Kent jobber in Chicago and the State of Illinois, as a distributor for the new Radi-"A," an "A" power supply unit. Large-space newspaper advertisements have been ap-

pearing regularly in Chicago newspapers to promote the sale of the Briggs & Stratton product, together with the names of dealers in the city and State who are handling it.

Co-operative Sonora Advertising

Full-page Sonora advertising has been appearing in the local newspapers for the past several weeks signed by twelve well-known Sonora dealers of this city. The advertising has been exceptionally forceful in character, featuring to splendid advantage the Sonora Shielded Six receiver and carrying illustrations of a timely character. For example, the full-page that appeared on Monday, November 22, five days prior to the famous Army-Navy game in this city, was headed "Touchdown" and emphasized the fact that every detail of the game could be thoroughly enjoyed by the owner of a Sonora Shielded Six in the comfort of his own living room. A football illustration carried out the idea of the copy, and the twelve dealers who have sponsored this campaign speak enthusiastically of the direct results received from this advertisement. The campaign will continue right up to Christmas. The Sonora dealers who are utilizing the newspapers to such exceptional advantage are the following: Becker, Ryan & Co.; Wolf Furniture House; Bacon Furniture Co.; Murray Electric Shop; Sekera Furniture House, Halsted Music Shop, Reliance Furniture House, Wonder Radio Sales Co., Faust's Brunswick Shop, O. R. Martin Co., Witzel Music Co. and Clark-Devon Radio Sales.

Victor Dealers Tie Up With Whiteman

With the appearance of Paul Whiteman and his orchestra, Victor artists, in Chicago for a period of three weeks, the Chicago Talking Machine Co., local Victor distributor, together with dealers throughout the city and surrounding territory, has brought about a very effective tie-up. Whiteman appeared at the Chicago Theatre the week of November 29, spent the second week on the stage of the Tivoli Theatre and the last week at the Uptown, the theatres being important houses in the Balaban & Katz circuit, located in the three most important trade centers in the city.

Because of Whiteman's popularity and the fact that he has made only three Chicago appearances the theatres have enjoyed capacity houses and interest in his recordings has greatly increased. Green and white window streamers together with cut-outs of Whiteman's face and



THE ALTO Automatic Stop
For Phonographs.

Nothing needs to be screwed onto the tone arm. Simple in construction. It fits under the turn table. Our customers say it is the most accurate stop they found yet in spite of its low cost.

ALTO MFG. CO., 1647-51 Wolfram Street CHICAGO
Canadian Distributor Universal Supply Co., Toronto, Ont.

lists of his records displayed in dealers' windows throughout the city have helped to draw attention to the Whiteman discs. In addition, the Chicago Talking Machine Co. and a number of dealers sponsored a full-page co-operative advertisement in one of the local newspapers showing on a map of the city the names and locations of the music stores where his recordings might be secured. According to reports from dealers throughout Chicago, the results have been very gratifying, and with the thousands who will hear Whiteman's orchestra before it finishes its engagement it is expected that the sales volume will mount considerably higher.

Novelty of Making "Movies" Grows

The home motion picture camera has an appeal which carries it into the possession of



Jack Dempsey Using Bell & Howell Camera

people in all walks of life, for the novelty of making "movies" and projecting them in the home seems to carry with it the same thrill as the owner of a new radio receiver feels when he first tunes in a distant station. The accompanying photograph shows three individuals who have been in the public eye for some time, Estelle Taylor, Jack Dempsey and William Beaudine, a prominent motion picture director. They were caught by the photographer at the M. G. M. Ball, at the Hotel Astor, New York City, with Mr. Beaudine in a typical directing pose and Mr. Dempsey acting as camera man with a Filmo camera, made by the Bell & Howell Co., of Chicago.

Organize Phonograph Art Society of Chicago

At a meeting held on November 30, there was organized The Phonograph Art Society of Chicago by a group of men and women interested in collecting and hearing music recorded for and reproduced by the phonograph, for the purpose of promoting a better appreciation of music generally. Other aims of the association are encouragement and assistance in the art of recording and in the wider and more general publication of records of the best of all music.

To promote the objects of the Society recitals will be held regularly in order to keep the members acquainted with the latest recording developments. Men and women connected with the phonograph industry, as individuals, in either the wholesale or retail divisions, are eligible for membership.

The Society, in its initial meeting, paid tribute to the work done by the National Gramophonic Society of Great Britain in organizing societies of similar character and signified its desire to

(Continued on page 104)



Repair Parts

For All and Every Motor That Was Ever Manufactured



We can supply any part. The largest and most complete assortment of repair parts—in the United States—on hand, for old, obsolete and present-day motors. If your order cannot be filled from stock, we will make it up special.

Special prices on main springs, governor springs, micras, repair parts, motors, tone arms, steel needles, etc., in quantity lots.

Expert repairing on all makes of phonographs and motors.



Consolidated Talking Machine Co.
Manufacturers of
High Grade Talking Machines, Disc Records, Talking Machine Supplies, Etc.

SUCCESSORS TO:
Standard Talking Machine Co.
United Talking Machine Co.
Harmony Talking Machine Co.
O'Neill-James Co.
Aretino Co.

227-229 W. WASHINGTON ST. CHICAGO ILL.
Branches: 2957 Gratiot Ave., Detroit, Mich. 1424 Washington Ave., South, Minneapolis, Minn.

TRADE MARK
"CONSOLA"
CABLE ADDRESS
"CONSOLA"

Jewel Brass Tone Arm and Concert Reproducer



Standard Length ten inches in stock. Made in nine or nine and one-half-inch lengths only on special quantity orders.

Patent No. 1419913
Other Patents Pending.

A HIGH-GRADE BRASS TONE ARM made with an instrument taper from the reproducer to the base. The patent floating felt lined soundproof collar insures a positive delivery of sound waves into the tone chamber, and carries a solid column of tone from the reproducer to the amplifier. The base flange is made of pressed steel four inches in diameter and is very strong and durable. The lower tubular part extends one inch through the motor board. Diameter of the tubular part 1 13/16 inches. Finished in beautiful ebony black, which harmonizes perfectly with either nickel or gold finish. List price Nickel \$15.00; Gold or Oxidized finish \$20.00.

JEWEL CONCERT REPRODUCER

VICTOR AND COLUMBIA DEALERS, increase your record sales. It is a well known fact that there are hundreds of thousands of phonographs, the owners of which have tired of them, consequently THEY BUY NO RECORDS. Revive these by selling them a JEWEL CONCERT REPRODUCER. IT IS especially adapted for the electrically recorded records, and a demonstration not only shows that it is much superior to the old style reproducer, but in almost every instance it means a sale. Attached in a minute. No tools required, no adjustment necessary. List price nickel plated \$5.00; gold or oxidized finish \$7.00.

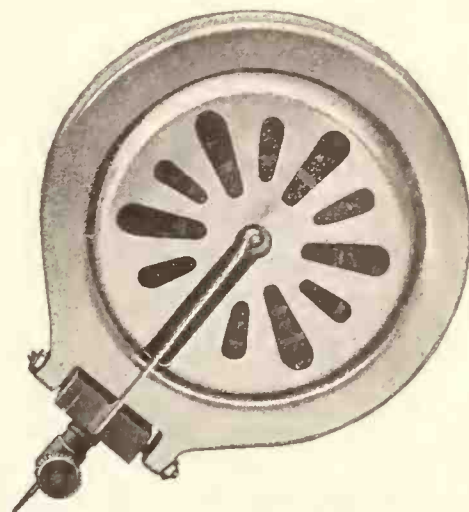

Back View

JEWEL TYPE B Loud Speaker Unit

This compact little unit represents a truly remarkable development. The substantial soft rubber hub eliminates metallic vibration, forms an air tight connection and makes a real loud speaker out of the Victor, Edison or any other good talking machine that has a standard size hub like the Victor. Simply take off the regular reproducer and put on the Jewel Type "B" Unit and you will have a speaker of ample volume with a full, clear, natural tone that must be heard to be appreciated. Takes up no more room than the regular reproducer and is easy to take off and put on without tools. Complete with Cord list price \$6.00.



Side View

Manufacturers and Dealers, write for discounts

154-160 Whiting Street



Chicago, Ill.

FROM OUR CHICAGO HEADQUARTERS—(Continued from page 102)

affiliate with the British organization, and work in harmony with its aims. The following officers were elected at the November 30 meeting: William Braid White, president; A. G. Ham-brock, vice-president; B. M. Mai, treasurer, and George W. Oman, secretary. Committees were appointed to work out the details of organization, programs and methods and will report at the next meeting, which will be held on December 14.

Electrical Research Lab.'s Staff Changes

Two changes were recently made in the sales organization of the Electrical Research Laboratories, Chicago, makers of Erla radio receiving apparatus, according to an announcement received from the firm's headquarters. V. W. Fitch was added to the staff as divisional sales manager of the Chicago territory, which includes the States of Illinois, Michigan, Iowa and Kentucky. Jack Mueller, formerly western Pennsylvania representative, has been transferred to the Boston district in the capacity of divisional sales manager. He has charge of Erla sales in Massachusetts, New Hampshire, Vermont, Maine and the western part of New York State.

Introduces New Type of Multi-Plug

A new type wall box Multi-Plug was recently announced by Howard B. Jones, of this city, manufacturer of the Jones Multi-Plug line for battery connections. The new product is a standard seven-contact socket mounted on a switch box cover and equipped with a regular cable and plug. Batteries and unsightly wires may be removed from the room entirely by installing the new plug socket in the baseboard of a room, and a connection from the batteries or power supply unit can be made in the same manner as a floor lamp. The dealer can demonstrate any number of sets for his prospects without changing battery leads, by simply interchanging the plugs and cables connected to his several receivers. The new plug, complete with a four-foot cable, retails for \$3.50.

Henry A. Otis to Represent Phonoparts Co.

A recent announcement of interest to the music trade contained news of the appointment of Henry A. Otis, Chicago, as Western representative of the Mutual Phonoparts Co., New York City, manufacturer of phonograph reproducers, tone arms and radio loud speaker units. Negotiations were completed in New York City between Mr. Otis, S. Garfinkel, president, and A. P. Frangipane, secretary, of the Mutual organ-

ization, as a result of which Mr. Otis will serve the territory west of the eastern boundaries of Michigan and Indiana, selling Mutual products to manufacturers and distributors. His appointment becomes effective January 1, 1927, and he will continue to maintain his headquarters at the Brewster Hotel, 500 Diversey Parkway, Chicago.

Mr. Otis is a prominent and popular member of the talking machine trade, his association with the industry dating back to 1913. He served as factory superintendent of the Perkins Phonograph Co., Chicago, for a period of eight years and is recognized as an authority on production, materials and plant management. He resigned from that position early in 1925, to accept the office of secretary of the Phonograph Manufacturers' National Association, a position which he now holds. His thorough knowledge of the phonograph manufacturers' problems, obtained through years of experience and contact in the trade, makes him particularly well fitted for his new connection.

Visits New York Sonora Headquarters

C. S. Tay, president of the Tay Sales Co., local Sonora distributor, and Ray Rielly, district manager of the Sonora Phonograph Co., spent the third week of November in New York City, making their headquarters at the general offices of the Sonora Co. On the return trip they stopped at Detroit, and at the Sonora plant in Saginaw, Mich., where they were the guests of John Herzog, vice-president of the firm, in charge of cabinet production.

Delta Electric Co. New Battery Charger

A new popular-priced radio accessory, the No. 12 Hi-Lo "A" battery charger, was recently introduced by the Delta Electric Co., Marion, Ind. The manufacturer, in the initial announcement, states that the charger, which is very compact, charges at either a high or low rate. It is a low rate small output or trickle charger, which by a special winding of the transformer coils has the additional feature of being easily converted to the full capacity of the tube by merely turning a toggle switch.

The "Hi" charging rate is approximately 1 1/4 amperes, the "Lo" rate approximately one-half ampere. It is adapted to 110 to 115 volts A. C., sixty cycle, and the makers state that the cost of operating the Delta "Hi-Lo" is one-tenth cent per hour. The container is of pressed steel, finished in rich mahogany baked enamel,



UNITED MOTORS

For All Types of PHONOGRAPHS

Quiet Easy Winding—Silent Operation—Quick Pick-up—True Pitch Reproduction—Long Life. Wearing parts protected by air-tight housing. Continuous Automatic Lubrication.

Write for Catalog

UNITED MFG. & DIST. CO.
9702 Cottage Grove Ave. Chicago

and the bulb and mechanism are completely enclosed. The Delta Electric Co. is prominent in the automotive and hardware fields as a man-

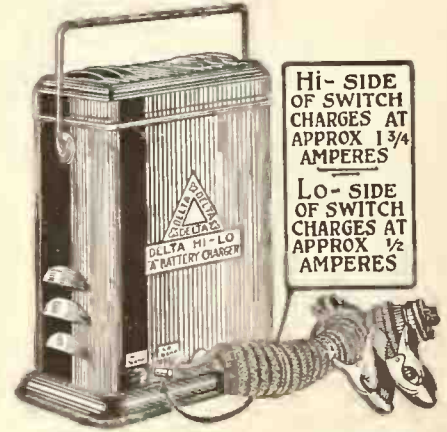

New Delta "A" Battery Charger manufacturer of spotlights, bicycle lamps and electric lanterns.

Radio Furniture Market Opened

The Radio Furniture Market, 215 West Madison street, Chicago, was opened a short time ago for the purpose of providing a center wherein lines of radio furniture manufacturers might be displayed. About twenty manufacturers have already placed their radio cabinets, tables and consoles on display at the Radio Furniture Market, where they may be inspected by the trade. The officials of the Radio Furniture Market act as sales representatives, selling to radio manufacturers, distributors and dealers. In case a consumer visits the display and wishes to purchase a cabinet, his name and address are referred immediately to the exhibitor or his nearest representative. The convenience of the location of the new institution and the homelike attractiveness of the displays have already evoked widespread comment and interest in the trade.

Decision of Significance

A decision of significance in view of the widespread interest in the radio broadcast situation was recently rendered by Judge Francis S. Wilson, of the Illinois Circuit Court, restraining station WGES from broadcasting on a wave length closer than 50 kilocycles to that of station WGN, operated by the Chicago Tribune. The decision is based on the principle that priority of time in the use of a wave length, and in the construction of equipment and expenditure of sums of money for broadcasting on this wave, creates a right to the unimpeded use of that wave channel which must not be violated by other stations.

H. G. Saal Co. Anticipated Henry Ford

That the H. G. Saal Co., manufacturer of Saal speakers and other radio equipment in this city, has been running on a five-working-day week for the past five years was learned through a recent interview with Leslie S. Gordon, president of the firm. Since the announcement of "Ford's five-day week," manufacturers generally have been forced to a consideration of this much-discussed plan, and it is interesting to note that the Saal Co., a pioneer in the radio field, anticipated the Ford plan by five years.

"Man for man," Mr. Gordon said, "we have (Continued on page 106)

ELECTRICAL SUPPLIES — RADIO

Don't place your Christmas Holiday order until you have seen the latest issue of Harry Alter's "POCKETBOOK," a 240 page catalog showing a complete line of Electrical and Radio goods, with a special section for Holiday Goods.



Your best source of supply.

Dealers: write for it today.

The Harry Alter Co.
ELECTRICAL and RADIO SUPPLIES
Ogden at Carroll Ave.
CHICAGO ILL.

GUARANTEE
 Buy a Utah and use it for two weeks. Compare its tone with the best the others are able to produce. **If the Utah does not give better reception** return it to your dealer and **he will refund your money.**

It's Here

The Sensation of 1927

The Newest Addition to the
 World's Most Complete
 Line of Speakers

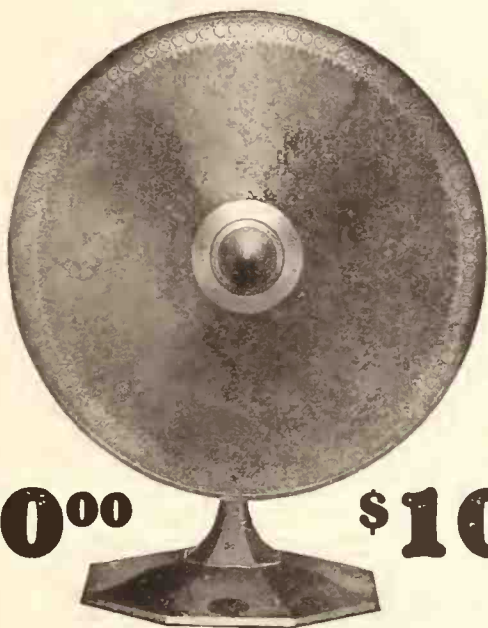

\$10⁰⁰ **\$10⁰⁰**

The New UTAH Cone Speaker

14½" high

Also Utah Cone Speaker
 Free Edge 17½ in. High **\$16⁰⁰**

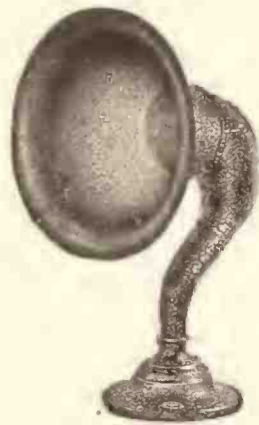

Utah Standard

14" Bell

\$22⁵⁰

The Speaker with
 the Golden Throat

Utah Junior

11" Bell

\$12.50

Utah Book Speaker

Looks like an open
 book

\$19⁰⁰

17½"x13½"



Utah Superflex

Reg. U. S. Pat. Off.

\$10⁰⁰



The only complete
 line of speakers
 on the market

We are
 manufacturers,
 not assemblers

Trade Mark Registered

UTAH RADIO PRODUCTS CO., 1421 S. Michigan Ave., CHICAGO

FROM OUR CHICAGO HEADQUARTERS—(Continued from page 104)

noticed greater efficiency. Increase has been more noticeable in the Summer, when the extra day can be spent outdoors, than in the Winter, when the weather necessitates his being indoors." The change was instituted at the request of the workers themselves. When the question was put to a vote among the employes of the various departments the result was practically unanimous. At the time the change was instituted the H. G. Saal Co. organized a recreation club, purchasing twenty acres and a clubhouse at Pistakee Bay, Ill., where the employes could spend the week-end holidays and thus derive full benefit from the extra day of freedom.

The Simplex Antenna Is Introduced

The Simplex Antenna, a new radio product, was introduced by G. H. Schubert, Chicago, a short time ago, and the announcement of the device marks the return to the music-radio industry of an individual whose acquaintance with the trade dates back many years. Mr.

Schubert was an Edison dealer in Reno, Nevada, in 1907 and 1908, later establishing himself in Chicago as a manufacturer of collapsible record racks for Edison cylinder records from 1908 to 1910. The rise in popularity of the disc record at that time caused him to discontinue manufacture, and it was only recently that Mr. Schubert again entered the music trade ranks, this time with an antenna.

Constructed on a unique principle, the Simplex Antenna is said to be suitable for any make of set from the crystal to the multi-tube receiver. It consists of a wooden staff, upon which is wound a conductor of special magnetic wire, scientifically constructed. Between the wooden staff and the seventy-five feet of magnetic coil is an insulating material, and the antenna is installed by mounting on a pole or rod, of either wood or metal, erected on the roof or other elevated object. The antenna, which retails for three dollars, is now being

handled by many dealers throughout the country and is said to be meeting with success wherever it is demonstrated and shown.

D. J. Quinn Sales Manager Sonotron Tube Co.

D. J. Quinn has been appointed general sales manager of the Sonotron Tube Co., Chicago, according to an announcement recently made by Harry Chirelstein, president of the firm. Mr. Quinn is a veteran of the Sonotron sales staff, having been associated with the organization for the past three years, is well known throughout the trade, and his many friends will be glad to learn of his new appointment. He will spend much of his time in travel, visiting important trade centers and working in co-operation with Sonotron dealers.

Product Is Known as Radi-"A"

Through an error, the name of the "A" power unit manufactured by the Briggs & Stratton Corp., Milwaukee, Wis., was misspelled in the November issue of this publication. The product is known as the Radi-"A" and operates direct from the light socket, eliminating both the A battery and charger.

Great Dealer Tie-Up With Sonora

Within recent weeks the Chicago trade has witnessed a particularly fine example of cooperative advertising on the part of Sonora dealers scattered throughout the city. Twelve dealers have contracted for six full pages in the Chicago Herald & Examiner, to appear on successive Monday mornings, in a campaign which will run through the period of holiday buying. Six other dealers have banded together and are using an advertisement, half-page in size, in four successive Sunday editions of the same publication.

American Electric Co., Inc., Makes Debut

The music-radio trade was interested in the announcement recently made of the incorporation of the American Electric Co., Chicago, which for some time has been engaged extensively in the manufacture of Burns radio apparatus, including speakers, units and battery eliminators. The extensive manufacturing facilities and engineering experiences of this company have been combined with the like resources of the Monarch Telephone & Manufacturing Co., also of Chicago, a firm equally as well known to the telephone and electrical appliance trade.

The organization is now known as the "American Electric Co., Inc.," and will continue to operate its large plant at Sixty-fourth and State streets, Chicago. An extensive manufacturing and advertising program has been planned, and with the added resources and increased engineering and sales forces the new organization announces that it will be in a position to give the trade whatever is required in service and the best possible in radio equipment.

Excellent Reports Regarding Radio Reception

The present radio season promises to be the best from a reception standpoint of any year since the development of radio, according to a prediction recently made by Leonard E. Parker, chief radio engineer of the Stewart-Warner Speedometer Corp., Chicago. His statement is based on information compiled by his assistants in the Stewart-Warner radio research laboratory, from reports received from over sixty-five points in the United States, and information collected through WBBM, the Stewart-Warner Air Theatre.

"I am basing my prediction on the results that have been apparent already," said Mr. Parker. "In our own laboratory we have observed unusual clarity of reception and have been able to bring in the most distant stations without much trouble. I have been particularly surprised at the absence of static, except on occasional nights. Distant stations have been coming through so well that we have had little difficulty in tuning them in through the maze of Chicago stations, which number, I believe, more than forty.

"We have also received reports that confirm our own information from our sixty-five Stew-

(Continued on page 108.)

New! TUBES That Bring Old Sets Up-to-Date!

Type
171-A
or
112-A

List Price
\$5

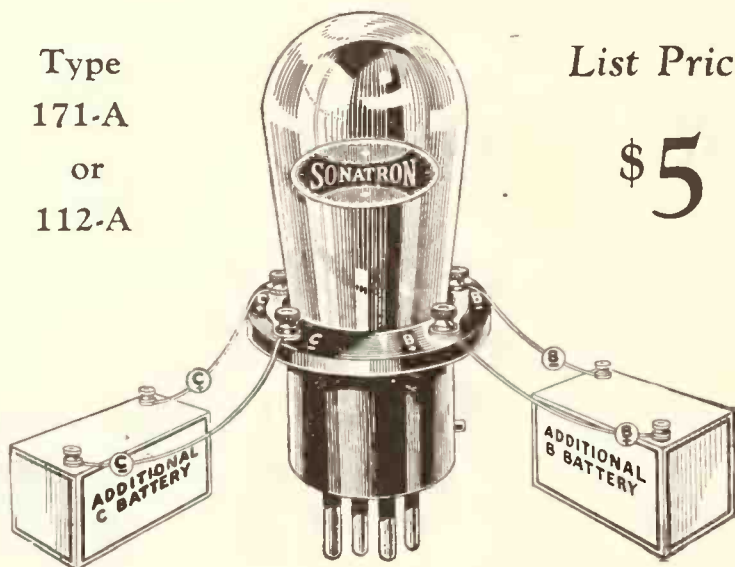

THERE'S big money for every dealer in bringing old sets up-to-date with these famous Sonatron tubes! They bring the advantages of power amplification to sets not wired for power tubes—and no re-wiring is necessary! Every owner of an old set is a prospect! Offered and guaranteed by the manufacturers of 30 distinct types of tubes.

Write for the Sonatron Proposition

SONATRON TUBE COMPANY

108 West Lake Street. Chicago

16 Hudson Street. New York City
Newark. N. J.

320 Lafayette Bldg., Detroit
Windsor, Ont., Canada

SONATRON

Nationally
Advertised



Standard
Quality

THE LARGEST LINE OF TUBES IN THE WORLD

A NEW Deal For Dealers!

There are certain factors which control the extent of every dealer's success. If every one of these factors are carried to the highest possible point your complete success is assured.

We are offering you A New Deal which does that very thing. It is of most importance to you—to every dealer of today.

You are in business to make money, build up a strong prestige, sell a product that not only satisfies but delights your customers—in fact, be the "hi-light" of dealers in your community.

Then you are interested in this New Deal, which also eradicates service worries and excess handling.

Find out all about this wonderful proposition, "A New Deal For Dealers." Do not wait until someone else beats you to it. Fill in the coupon and mail in today—NOW.

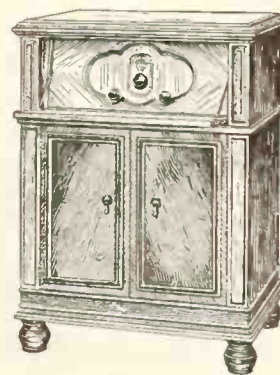
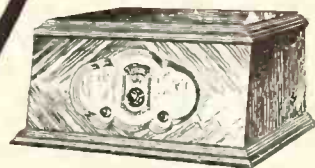

ELECTRICAL RESEARCH LABORATORIES
 2500 Cottage Grove Avenue, Dept. D52, Chicago, Illinois

Please send me complete data regarding your "New Deal For Radio Dealers." I understand that this inquiry opens up a new avenue of profits and does not obligate me in any way.

Name _____

Firm Name _____

Address _____

ELECTRICAL RESEARCH LABORATORIES



CHICAGO, ILLINOIS, U. S. A.

FROM OUR CHICAGO HEADQUARTERS—(Continued from page 106)

art-Warner distributors scattered all over the United States. They report that they have been able to receive distant stations with a minimum of interference or at least with only such interference as can be attributed largely to natural conditions.

"There is no question of the fact that to-day there are too many broadcasting stations on the air, but such interference is man-made and has nothing to do with natural law. Consequently, my prediction is based purely on weather conditions. Insofar as the crowded condition of the broadcasting wave band is concerned, we are of the opinion that decisive action on the part of Congress is absolutely necessary and essential. Despite this condition, however, I have reports from our broadcasting station, WBBM, which show that it has been received with a minimum of fading and static in practically every State in the Union."

An Important Business Move

Negotiations were recently completed between the Grigsby-Grunow-Hinds Co., Chicago, makers of Majestic "B" battery eliminator, and the Metal Devices Corp., also of Chicago, through which the latter firm will manufacture and market the Majestic loud speaker. The Majestic reproducer was formerly made by the Grigsby-Grunow-Hinds Co., whose plant is now devoted entirely to the production of the popular Majestic "B" power units.

O. E. Grigsby, formerly vice-president of the Grigsby-Grunow-Hinds Co., is president of the Metal Devices Corp., and under his direction the Majestic loud speaker is being built and merchandised. The firm also manufactures a doll which talks and sings through the use of a small phonograph enclosed within it.

H. Emerson Yorke Loses Mother

H. Emerson Yorke, manager of the publicity department of the phonograph division of the Brunswick-Balke-Collender Co., is receiving the sympathy of his many friends in the trade upon the death of his mother. Mrs. Yorke, who had been ill for quite some time, passed away a few weeks ago at the home of her daughter in Ottawa, Can. Mr. Yorke attended the funeral and on his way to Chicago stopped off at the New York Offices of the Brunswick Co.

Panatrope Replaces Band

A Brunswick Panatrope has superseded the band at the Hawthorne Jockey Club racetrack on the outskirts of this city. That this experiment is proving highly successful is indicated

Sell the "Molliformer" THE "B" UNIT That Is Guaranteed Low in Cost, Unequaled Tone Quality, Ample, Uniform Power—In Use Two Years

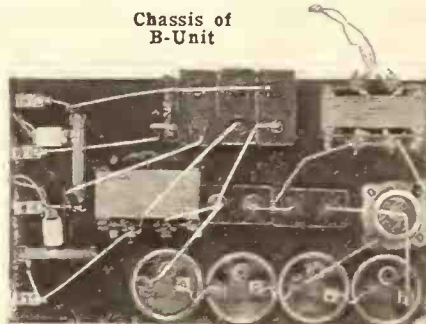

The "Molliformer" "B" Unit Ready for Use

The "Molliformer" is backed by two years of startling performance that has placed this unit far in advance of all other "B" Eliminators. The "Molliformer" assures years of service without attention. There are no acids to spill—no corrosive fumes—no expensive, critical rectifying tubes. Thousands of users endorse the "Molliformer" for the long-lived, dependable service it affords.

- Two "Molliformer" Models—Completely Assembled—Ready for Use
Model FW4, 35 milliamperes at 90 volts.....\$22.00
Model D4, 40 milliamperes at 150 volts..... 27.50

Units for 25 and 40 cycle current \$2 additional

EXCLUSIVE TERRITORY

Write today for discounts. Exclusive territory still available. Circulars sent upon request.

C. E. JACOBS, Sole Manufacturer
2808 N. Kedzie Avenue, CHICAGO

by the fact that numerous requests for various popular selections are made daily and patrons of the track are extremely enthusiastic over the innovation.

Sonora Shop Opened in Republic Building

The Sonora Music Shop was recently opened on the fifth floor of the Republic Building, Chicago, by Matt J. Kennedy, one of the most prominent members in the music trade. Mr. Kennedy is an important factor in the wholesale piano business and the addition of a radio department marks his first entrance into the field of radio merchandising.

The new department, in which will be handled the complete line of Sonora reproducing phonographs and radio receivers, will be under the direct charge of John J. Kelly, who has had an extensive background of experience in the phonograph and radio retail fields, especially in the selling of products made by the Sonora Co.

Mr. Kennedy has enlarged his headquarters until the organization practically uses one-quarter of the entire floor of the Republic Build-



M. J. Kennedy

ing. He is president of the National Piano Travelers Association, and is popularly known as the man who "put the Piano Club of Chicago on the map."

Here's a Traveler

I. Hannan, of New York City, one of the Talking Machine World's old friends, claims the distinction of being the greatest traveled subscriber to this well-known magazine. He crosses the ocean to England or back again nearly every week—forty times a year for forty years—a total approximately of four million miles to his credit.

Hadley Co. Chartered

The Hadley Co., Chicago, Ill., was recently incorporated, with a capital stock of \$60,000, to deal in talking machines, radio apparatus and furniture. The incorporators are H. W. Barsel, J. Alroy, Mose Felder and M. H. Rosenthal.

Everyone wants to do it a little better than the others. . . .

Everyone wants to be ahead of the times—to be different—to excel. . . .

SO DO WE

—but in extending our season's greetings to our friends, we want to do it in the good old fashioned way and say with the feelings and spirit our forefathers did

A Merry Christmas and A Happy New Year

TARG & DINNER MUSIC CO. "The Wholesale Music Center"

229 W. RANDOLPH ST.

CHICAGO, ILLINOIS



Grigsby-Grunow-Hinds Co. Seeks Name for "B" Supply

Manufacturer of Majestic "B" Current Supply Invites Name and Slogan for Product—\$1,000 to Be Awarded to Coiner of Winning Slogan

December 1 marked the opening date of a contest sponsored by the Grigsby-Grunow-Hinds Co., Chicago, through which the consumer public is invited to send in suggestions for a name and a slogan for the Majestic "B" Current Supply, manufactured by the firm. Believing that the words "B Current Supply" and slogan can be improved, the Grigsby-Grunow-Hinds Co. is offering a cash prize of \$1,000 to the person sending the best suggestion, together with a short letter giving reasons for the proposed name and slogan. In the initial announcement it was stated that the name "Majestic" is to be retained, but the firm is seeking a new and better word or phrase for "B Current Supply."

An extensive advertising program is to be sponsored to announce the contest and urge newspaper readers throughout the country to visit the nearest Majestic dealer for a demonstration of the product. A series of advertisements will appear in over fifty metropolitan newspapers each week, the campaign being launched on January 2 and ending on January 29, when the contest will close at midnight. The prize contest will undoubtedly focus the attention of millions of radio fans on the popular Grigsby product.

Window streamers, counter display cards and other sales promotion material for dealers' use have already been placed in the hands of distributors of the Majestic current supply and the contest will doubtless bring forth a tremendous public interest in the product itself and an increase in sales to those dealers who are handling it.

The final decision as to the winner of the contest will rest in the hands of a judge, or a committee of judges, in either case the decision being made by individuals not connected with the Grigsby-Grunow-Hinds organization in any way. The award of the judges will be published in the February 15 issue of *The World* and all correspondence relating to the contest is to be addressed to Contest Manager, care of Grigsby-Grunow-Hinds Co., Chicago.

Walter Damrosch Continues Balkite Opera Recitals

Walter Damrosch, world-famous conductor, who is giving a series of radio concerts over a chain of thirteen stations, during the Balkite Hour, arranged by the Fansteel Products Co., Inc., gave the first act of "Siegfried" on November 27 and Acts 2 and 3 on December 11. On December 18 Mr. Damrosch will continue his series of Wagnerian lecture-recitals with the broadcasting of the first two acts of "Gotterdammerung." Throughout the series Mr. Damrosch tells the story of the opera and recites passages from it and then renders the music on the piano. On Christmas night during the Balkite Hour the New York Symphony Orchestra, under Mr. Damrosch, will give a concert.

Victor Co. Registers Slogan

WASHINGTON, D. C., December 3.—The United States Patent Office reports that the Victor Talking Machine Co., Camden, N. J., has applied for registration of the phrase "The Gift That Keeps on Giving" as a trade-mark for talking machines and parts thereof, talking machine records and talking machines and parts thereof adapted for combination with radio sets.

The Jordan Music House, Charleston, S. C., is experiencing a big demand for the Edison long-playing record.

New Columbia Accounts Opened in Buffalo Field

VerBeck Musical Sales Co. and S. J. Butler Among Dealers in Western New York District to Take on the Viva-tonal

BUFFALO, N. Y., December 8.—Several new and important Columbia accounts have been opened in this territory during the past few weeks by E. L. Wallace, manager of the local distributing office. Among them are the VerBeck Musical Sales Co., on Main street, and S. J. Butler, on Jefferson avenue. Mr. Wallace is exceptionally well pleased with the manner in which the Viva-tonal and Columbia records are being accepted by the consuming public as well as the trade. Record sales are climbing to new heights, and the Viva-tonals are moving from dealers' floors almost as rapidly as they are received. The Columbia Music Shop, on Michigan avenue, has greatly stimulated business through its broadcasting station, which sends on the air each afternoon musical programs featuring Columbia artists. Exploitation of records made by "The Buffalonians," a local dance orchestra, has just begun, Mr. Wallace said. This organization is claimed by local dance enthusiasts to be one of the finest of its kind in this part of the country, and its popularity will undoubtedly boost Columbia records generally, in Mr. Wallace's opinion. Their programs are received by radio fans who tune in on WEBR, the Columbia Music Shop's broadcasting station. Mr. Blumenthal, representing the foreign department of the Columbia Co. in New York, visited the trade of this district recently, stimulating new interest in Columbia foreign records.

Birnbach Radio Products Have Good Trade Reception

The Birnbach loud speaker extension cord unit, manufactured by the Birnbach Radio Co., New York, has met with a splendid reception among the trade and a healthy demand has been experienced for this radio accessory. It permits moving the loud speaker to any point of the room without disturbing the receiver, and allows the operation of several loud speakers in various rooms in the home. Other radio accessories manufactured by the Birnbach Radio Co. include battery cables, head set and loud-speaker cords and battery connectors.



Horns
\$22.50—\$25.00
Units
\$10.00—\$12.00

**DOUBLE ENJOYMENT
VOLUME WITH PERFECT TONE
WITH**

**Burns
LOUD SPEAKER**

Why sacrifice the excellent work of the set by using an inferior speaker? A BURNS will reproduce with pleasing exactness every tone and sound that the set can pick up.

WRITE FOR TRADE PROPOSITION

American Electric Company
Incorporated
State and 64th Streets
CHICAGO, U. S. A.

Ask about Burns "B" Eliminator

Amsco Orthophone Introduced

Broadening its activities in the radio accessory field, Amsco Products, Inc., New York, has announced the production of the Amsco Orthophone. The Orthophone is a unit designed to be connected between any loud speaker and receiver. It is said that the use of the Orthophone protects the loud speaker in several ways and results in increased volume and improved quality without distortion. Officials of the Amsco organization state that the Orthophone will appeal particularly to the users of the new power tubes, and it is stated that the manufacturers of power tubes now recommend this output arrangement, advising against the inclusion of the speaker directly in the plate circuit of the tube.

Moore-Bird & Co., Denver, Colo., will distribute the Balkite line of power units.

**Christmas
Greetings
to the
Trade**

THE ORO-TONE COMPANY
1010 George St. Chicago, Ill.

Radio Co-ordinating Committee Urges Emergency Broadcasting Control Measure

Four-day Conference in Washington by Committee Representing All Branches of the Radio Industry Results in Report Asking Congress to Take Definite Action

WASHINGTON, D. C., December 6.—The National Radio Co-ordinating Committee, representing all branches of the radio industry, organized transmitting amateurs and numerous listeners' leagues, met in conference at Washington for four days and on December 3 issued a report urging that Congress, which meets to-day, enact an emergency control measure to prevent the granting of licenses to any more broadcasting stations after to-day. The committee also urged that the control of radio be placed in the hands of a Federal Radio Commission and the Department of Commerce.

It is vitally necessary, the committee stated in its report, that legislation controlling radio be enacted during the present session of Congress and to this end it seemed that two steps appeared necessary:

"1. The enactment of an emergency control measure which will prevent the further complication of an already complicated situation by prohibiting the issuance of any more licenses for the operation of radio broadcasting stations after December 6, 1926.

"2. The bringing out of conference of a comprehensive and adequate general law governing the whole radio industry.

"The emergency control measure is necessary because broadcasting stations are now increasing at such a rate—to be specific, one a day—as to cause not only confusion on the air but the possibility of even greater confusion."

Regarding the form of Federal control, the committee stated that it preferred not to make a statement in favor of either the White or the Dill bills, but felt obliged to express an opinion, "based solely on the idea of the good of the industry and the radio listener."

The report continued:

"Having made our position clear, the committee, eliminating all considerations except those for the good of the radio listener and the industry and the existing subject matter in the Senate and House bills, favors a control consisting of two bodies—a Federal Radio Commission and the Department of Commerce, whose functions shall be as determined in the

House bill. These functions should be so adjusted in the administrative powers as to clearly demonstrate the standards used in cases for decision as hereinafter recommended and to define and clarify large discretionary powers and control in the commission.

"The committee understands that this proposed Federal Radio Commission has full appellate powers and can hear and decide cases arising both in and outside of the Department of Commerce, and that there is a final appeal to a Federal court from the decision of the commission."

With reference to the allocation and use of wave lengths the report suggested that they be determined on the basis of the following factors:

"1. The length of time during which stations, existing at the time this act becomes law, have operated.

"2. The character of service rendered by them.

"3. The requirements of their zones and communities for radio service.

"To state it briefly, the doctrine we have developed may be said to be as follows: A broadcaster has no vested rights as against the United States Government, but he has certain clearly defined rights as against other broadcasters."

The term of radio licenses, the committee said, should not be for less than five years, providing that the licensee is operating his station "properly and regularly."

Walter A. Strong, of Chicago, was chairman of the committee which rendered the report. Other signers included Paul B. Klugh, executive chairman, National Association of Broadcasters; Arthur T. Haugh, president of the Radio Manufacturers' Association; R. W. Demott, president of the Radio Magazine Publishers' Association; Louis B. F. Raycroft, chairman, Radio Section, National Electrical Manufacturers' Association; Charles H. Stewart, vice-president, American Radio Relay League; Harold J. Wrape, president, Federated Radio Trades Association, and Elisha Hanson, counsel, Newspaper Broadcasters Committee.

Simplex Antenna

Is proving a sensation with set owners. Dealers, too, are enthusiastic. Gets everything in the air—BETTER. Non-directional. Non-interfering. Easily and quickly installed. Consists of a staff on which is wound a novel conductor coil which renders a 12-inductance that produces a volume of natural tones and places the SIMPLEX in a class by itself.

DEALERS: You can install a SIMPLEX with every set you sell. List, \$3.00. Sample in U. S., \$1.85; 3 for \$5.40, postpaid. Sold on money-back guarantee.

G. H. SCHUBERT, Mfr.
753 W. 32d St., Chicago, Ill.

Chicago Thermiodyne Jobber Features Pirate Chest Set

Henry Paulson & Co., Distributors, Devote Cover of Catalog to Illustration of Thermiodyne Pirate Chest Receiving Set

The new Fifteenth Century Pirate Chest Thermiodyne receiver, manufactured by the Algonquin Electric Co., New York, was featured

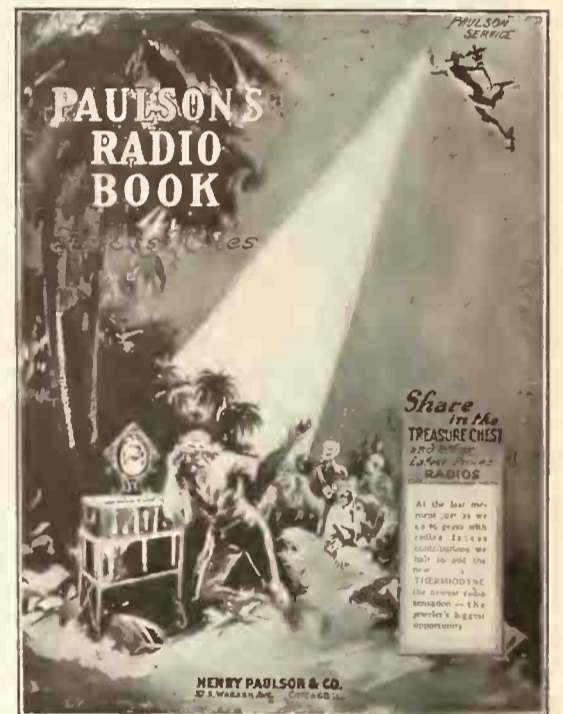

Cover of Henry Paulson & Co.'s Catalog in a unique way in the latest catalog issued by Henry Paulson & Co., Chicago, Ill., well-known radio jobbers who are handling the new Thermiodyne. The front page of "Paulson's Radio Book," reproduced herewith, is devoted to a striking illustration of the discovery of the new Thermiodyne Pirate Chest by a band of pirates on a tropic island. Lee Potter, president of the Algonquin Electric Co., states that the organization is very much gratified by the enthusiastic reception accorded the new Thermiodyne receiver, which was described in detail in a previous issue of The World.

Plaza Music Co. Issues Xmas Portable Sales Aids

Each year at this season the Plaza Music Co. makes a special effort to encourage talking machine retailers to take advantage of the possibilities in portable talking machine sales. For the past several years the holiday period has been an unusually active one for portable talking machines. Bearing this in mind and based upon past sales experience the Plaza Music Co., manufacturer of the Pal portable, has issued much Christmas and other holiday sales literature. This material includes window strips, cut-outs, placards and circular matter. The text of this advertising matter is all in a holiday vein and carries persuasive arguments for the Pal portable as gifts.

Davega, Inc., New York, has declared an extra dividend of 25 cents in addition to the regular dividend, payable February 1.



Imperial Phonogrand

are equipped with our NEW TRIPARTITE AMPLIFIERS.

Three scientifically proportioned and designed Tone Chambers combine in one Unit.

They will please the Dealer who is looking for volume Reproduction without sacrificing quality.

PHONOGRANDS MAKE SELLING EASIER.

The Tone, the Quality and the Prices are right.

Send for Catalog and Prices
FOREIGN INQUIRIES SOLICITED

Phonogrand Division

FUEHR & STEMMER PIANO CO.
1934 Wentworth Avenue Chicago, Ill., U. S. A.
Musical Instrument Builders for 25 years

IMPERIAL MODEL
46" High, 24" Wide, 22" Deep.
List Price, \$150.00

Would you like *Some of this* \$2000.00?

Do you own or operate a store selling radio supplies? Given all material, can you trim a window so that it will make folks stop, look and listen? If so, you are eligible to join this

Awards

- First Prize:
\$500.00 in Gold
- Second Prize:
\$250.00 in Gold
- Third Prize:
\$200.00 in Gold
- Fourth Prize:
\$150.00 in Gold
- Fifth Prize:
\$100.00 in Gold
- Sixth Prize:
\$100.00 in Gold
- Seventh to Twentieth Prizes:
14 Gold Awards
\$50.00 each

\$2,000.00 PRIZE CONTEST

*for winning window displays of
advertising material featuring the*

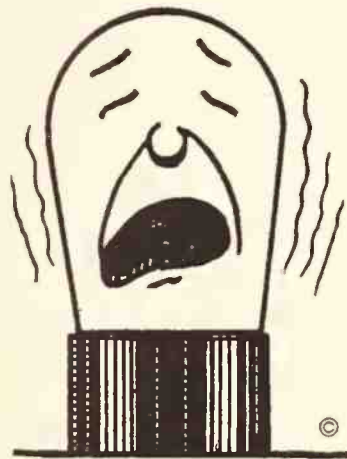

It howls!

MC DONALD HOWL ARRESTER

"It Stops that Howl"

TRADE MARK

Patented Dec. 7, 1926. No. 1,610,208

*Infringers will be vigorously proceeded
against.*

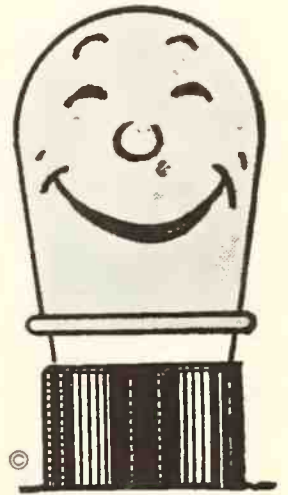

Now it doesn't!

From now until February 15th, 1927

the contest is on. You don't have to buy a thing. We furnish without charge complete advertising material for your windows and give you suggestions for displaying it to best advantage.

Winners

Announcement of winners and photograph of winning display, together with photo of winning decorator will appear in the *March*—instead of, as previously announced, the *February*—issues of the Radio Dealer, Talking Machine World, Radio Record, Radio Retailing, Electrical Record, Radio Doings, etc.

Fair Play for All

Each display will be judged as to its Originality, Effectiveness and Good Taste by the Committee of Five disinterested judges well known in the radio field. Your opportunity is as good as any.

Let your window bring you tangible profit!

ALL ABOARD! 
*Cut me out and
mail me Right NOW!*

SPARTAN ELECTRIC CORP., 350 W. 34th St., N.Y. C.
Kindly send, without obligation to me, full particulars about your \$2000.00 Prize Contest for Best Window Displays of Advertising Material featuring the McDonald Howl Arrester.

Name and Title.....
Name of Firm.....
Address.....

New York Bankers Secure Control of the Victor Co.

(Continued from page 3)

The banking interests in taking over control of the company stated that the continuity of the present management would be preserved after the change in ownership and that further announcements regarding the future plans for the company would be made at an early date.

The present officers of the company are: E. R. Johnson, president; B. G. Royal, E. R. F. Johnson and E. E. Shumaker, vice-presidents; E. K. MacEwan, secretary; W. H. Hunt, assistant secretary; W. J. Staats, treasurer; E. C. Grimley, comptroller and assistant treasurer, and G. W. Jagers and F. B. Middleton, Jr., assistant comptrollers. The directors of the company are: E. R. Johnson, E. R. F. Johnson, L. L. Rue, B. G. Royal, W. J. Staats, A. W. Atkinson, E. E. Shumaker, C. J. Child and Alfred Clark.

Make Sales Campaign on "Playtime" Recordings

Plaza Music Co. Putting Special Impetus Behind Children's Records—Circular and Display Material Sent to Dealers

Throughout the month of December the Plaza Music Co., 10 West Twentieth street, New York City, is making a special sales campaign on its "Playtime" records. These products are seven-inch double-faced records embodying songs, games and stories for children. The titles include practically all of the familiar songs of the nursery. Such records as "Jack and Jill" "Old King Cole," "Sing a Song of Sixpence," "Mother Goose" are all available in this catalog.

In conjunction with its special sales drive the Plaza Music Co. has issued much circular matter and display material for dealers' use. The sales department of the company states that these records have a ready sale wherever displayed and when placed in a prominent position in the store together with the sales literature substantially increased sales are made.

Landay Bros. Hold Opening in New Haven

NEW HAVEN, CONN., December 6.—Formal opening of the new Landay Hall, local headquarters for Landay Bros., Inc., at 790 Chapel street, was held here recently and several hundred patrons were shown through the estab-

WALL-KANE

THE ORIGINAL 10-RECORD NEEDLE PUT UP IN ATTRACTIVE COUNTER DISPLAYS

GIVES YOU 150% PROFIT

Also Jazz, Concert, Petmecky and Best Tone Phonograph Needles

WALL-KANE NEEDLE MFG. CO., Inc., 3922—14th Ave., Brooklyn, N. Y.

lishment. The quarters have been lavishly decorated in a manner suitable to the extensive displays of all kinds of music goods. The piano department, under the management of John McAdams, includes Estey period model grands, Behr Bros. pianos and other makes. Brunswick and Victor talking machines and a full stock of both kinds of records are handled in the phonograph department. Sheet music, small goods and radio are also carried in separate departments. The new Landay store here is under the management of Michael M. Slone.

J. A. Fischer Co. Features Val Phonic in Broadside

Attractive Publicity on Reproducer Issued by Maker of Valley Forge Line

PHILADELPHIA, PA., December 8.—The J. A. Fischer Co., maker of Valley Forge main springs and talking machine repair material, of this city, has issued an attractive broadside on the Val Phonic reproducer. It features the reproducer itself and the Val Phonic outfit, including the Valley Forge tone arm and the

Val Phonic attachment for the Edison. There is also shown the Bridgeport attachment for the Edison, the new Bridgeport reproducer and the Valley Forge tone arm. The first page of the broadside is devoted to an interesting analysis of the market for the new type of reproducer as experienced by the J. A. Fischer Co.

In referring to this broadside, J. A. Fischer, president of the company, states: "The returns from the latest broadside on the Val Phonic reproducer have been very gratifying. When the Val Phonic reproducer was first conceived no thought was given to production and after many months of experimentation along original lines the sale of the Val Phonic reached the point that we have twice had to double our production. This has encouraged us to build new tools that will make it possible for us to deliver in tremendous quantities. This is the third step in the history of the Val Phonic and from present indications it would seem that still further expansion would be necessary before long."

Royal Blue Model Cabinet Selected as 1927 Leader

Rockford Sales Corp. Announces Model 540 as Leader of Complete Line of Radio Cabinets—Contains Loud Speaker and Battery Space

The Royal Blue model No. 540 has been selected by the Rockford Sales Corp., Division of the Federal Furniture Factories, Inc., New York, as its leader for the 1927 season. This "Cabinet, by Irving," which includes a loud speaker and battery compartments, is an attractive piece of furniture and is built to accommodate the Atwater Kent compact and other standard models.

The Federal Furniture Factories, Inc., operate a number of large furniture factories throughout the country and maintain extensive display headquarters at the Furniture Exchange, 206 Lexington avenue, New York City. The Rockford Sales Corp., Division of Federal Furniture Factories, Inc., has entirely to do with radio cabinets. Practically every known style of radio cabinet is included in the line of which the Royal Blue model is the leader. In an announcement made by David E. Kahn, director of sales, he refers to the new price standard established by this leader and reports that the output for 1927 is already being rapidly absorbed.

Without Question
America's Finest
RADIO CABINETS

New Catalog for Season 1926-1927 Just Off Press

Write Today

Unless You Have a Few of These High-Grade, Quality Cabinets on Your Sales Floor You Cannot Serve Your Good Customers.

Cabinets for Every Purpose—Three Complete Lines

THE PIERSON COMPANY, 836 Cedar Street, ROCKFORD, ILL.

The "Radiano" Makes Its Debut in the "Twin Cities"

Attached to Sounding Board of Piano, It Eliminates the Microphone in Transmission and Loud Speaker in Reception

Announcement was made recently of a new device called the "Radiano," which, attached to the sounding board of a piano, eliminates the microphone when used in broadcasting piano numbers. When used for reception purposes it "converts the piano into a loud speaker, from which all sounds, including speech, but particularly piano numbers, are reproduced with remarkable fidelity," state the inventors, Fred W. Roehm and Frank W. Adsit, of St. Paul,

Minn. When used in receiving, the "Radiano" is connected with the receiving set and the sounding board reacts similarly to the diaphragm of a loud speaker. Demonstrations are said to have shown it capable of loud volume without distortion. Mr. Roehm states that arrangements are being made to have the device manufactured and assembled by one of the leading radio corporations of America.

On Monday evening, November 29, piano music was broadcast through station WCCO, St. Paul, without the use of a microphone, but with the "Radiano" attachment, and the program was received at a Minneapolis, Minn., music store without the conventional loud speaker, but with a "Radiano" attachment to a grand piano. One of the local newspapers reported that at the music store "the 'Radiano'

used on the grand piano created the impression that the receiving piano was playing itself. The tones were such as seldom have been achieved through the familiar types of loud speaker."

Gibbs Co. Opens Branch

MERIDEN, CONN., December 6.—The Gibbs Piano Co., of Springfield, Mass., has opened a branch store here at 88 West Main street. J. C. Lavianna is manager of the new store, which will handle a complete line of pianos and other musical instruments. The Gibbs Piano Co. maintains branches in Springfield, Pittsburgh, Holyoke, Hartford, New Britain and Torrington. This concern is one of the most successful in the New England section.

Announcing

Another

New and Improved
FRESHMAN
MASTERPIECE

Console with Built-in Cone Speaker!



Made of the finest

GENUINE MAHOGANY

this Freshman Console contains the new Quality Freshman Masterpiece radio.

A LARGE CONE SPEAKER

is embedded in the center of the compartment immediately below the set—providing ample room for all accessories on either side. Sturdy and compact, this console measures 36 inches high and 31 inches wide.

**Sold to Authorized
FRESHMAN Dealers Only**

Write for complete information about the FRESHMAN FRANCHISE—the most valuable in radio.

CHAS. FRESHMAN CO., INC.
Freshman Bldg., New York
2626 W. Washington Blvd.
Chicago

\$79⁵⁰

Model 6-F-16

Columbia Sales Volume in the Baltimore Territory Reaches a New High Figure

W. H. Swartz, of Columbia Wholesalers, Inc., Declares November Business Smashed All Previous Records—200 Per Cent Gain in Foreign Record Sales—Demand Covers All Lines

BALTIMORE, MD., December 10.—Columbia business during the month of November was astonishingly good, being the largest Columbia month thus far recorded, according to W. H. Swartz, vice-president of Columbia Wholesalers, Inc.

"October had previously smashed all sales records, but November set a new mark.

Good Demand for Large Instruments

"It is very pleasing to see the surprising number of larger machines dealers in even the very small towns have been selling," said Mr. Swartz. "Smashing full-page advertisements coming every month in the big newspapers with the smaller advertisements running two or three times a month, coupled with the wonderful double-page spreads in such magazines as the Saturday Evening Post, and exciting dealers' enthusiasm have helped accomplish the big results noted above. Many dealers put in a Columbia advertisement every week featuring both machines and records, some agents advertising twice a week. This is being backed up by a lot of special circulars, window displays, etc., so that people in this section have seen the name Columbia more frequently than ever before.

"Hecht Brothers had an unusually fine window display in both their big stores, at Howard and Franklin, and Baltimore and Pine streets. Isaac Benesch, one of Baltimore's largest department stores, also devoted a whole window to Columbia exclusively, getting fine results through the use of special lighting effects on the Viva-tonals.

"Columbia dealers in this section enjoyed increased sales through appearance at a local theatre of Al Lentz and His Orchestra.

Foreign Record Sales Increase

"Foreign record business in Baltimore and Washington is showing an increase of nearly 200 per cent ahead of last year. A local Bohemian paper carried three half-page advertisements by the Klecka Levy Co., the Baltimore German paper carried a full-page advertisement, inserted by five dealers grouping together. The Italian paper has carried a Co-

lumbia ad every week, whereas this time last year none of these papers had known of Columbia advertising.

"The Italian colony of Baltimore gave a large ball at the Knights of Columbus Hall to raise money for a Valentino memorial during the showing of the special Valentino film. The audience also was entertained by a big Viva-tonal Columbia placed on the stage. Kaufman Music Shop arranged this special display and got quite a few prospects.

Stages Successful Demonstration

"The Shepser Music Co., of Cumberland, arranged a big Columbia demonstration in its local theatre, having a large display of all the new Viva-tonals. Large crowds were attracted. Many other dealers have written in dealing with Viva-tonal demonstrations before Rotary Clubs, Lion Clubs, Parent Teachers' Associations and other organizations.

"The G. Fred Krantz Music Co., one of Baltimore's finest music stores, reports the sale of quite a few models No. 611 to Baltimore schools.

"R. J. Riley, popular Columbia representative for Washington and Virginia territory, announces with pride the arrival of Raymond J. Riley, Jr. Mr. Riley's many friends in the dealer organization have joined in hearty congratulations."

Radio sales, although still much retarded through lack of stock, are nevertheless ahead of November, 1925, the increase coming especially in the sale of the fine new sets now put out by F. A. D. Andrea, Inc., as well as by the Crosley and Mohawk Co.

Radio Holds Its Own

The new Fada eight-tube sets have taken the trade by storm due to their marvelous tone qualities. Dealers are so enthusiastic over this new product that the Baltimore agents grouped together last Sunday and put in a full-page advertisement in the Baltimore Sun on Fada exclusively. Burgess batteries and Philco eliminators are selling heavily. Incoming carloads have not even been put in the warehouse, as these units were sold before machines arrived.

W. F. Roberts, manager of E. F. Droop &

Sons, Inc., Victor jobbers, said: "Business for the first few days of this month has been phenomenal, and we are oversold on practically all models of the Orthophonic, especially those selling around \$300.00. Our business last month showed an increase of 100 per cent over November, 1925, and in October we did two and one-half times as much business as during the corresponding month last year. Our chief difficulty to-day is not selling the goods but getting the goods after they are sold. We have been completely sold out for the past six weeks and the best we can do with the small shipments received is to give a dealer about one or two machines of a model where he wants ten. The record business, for the past few months, has shown large increases right along and dealers to-day are buying twenty-five and fifty records of a single piece or song, where before they bought about half a dozen or so."

Shortage of popular models of the Panatropé, especially the Cordova, still exists and lack of Seville, Madrid, Cortez and Valencia models is seriously handicapping the local agency of the Brunswick Co., according to Manager Charles F. Shaw. "We have been oversold on all these models for some time," he declared, "and especially so on the electrically operated P-11 and P-R-148, as well as phonographs with radio combinations. This is especially true on the high-priced combination machines, which are meeting with good sales in this territory. The record business also continues to show large increases each month, and especially for Vocalion records." Mr. Shaw, who has just returned from a business trip to Chicago and stopped off for a visit in St. Louis, where he represented the Brunswick before coming to Baltimore, has just been elected a member of the Kiwanis Club of Baltimore as representing the wholesale phonograph and radio industry.

Dealers Add New Lines

New dealers recently signed up as Brunswick dealers include Gilmor-Ham-Snyder, of Charlottesville, Va.; J. N. O. W. Graves, of Danville, Va.; Hanson & Hodges, of Covington, Va., and Atkinson & Thomas Furniture Co., of Southern Pines, N. C.

New Vocalion dealers signed up by the agency include L. H. DeWese, of Klen Lyn, Va.; A. F. Hornig, Baltimore; Chas. M. Lee, Cumberland, Md.; Adams Music Co., Statesville, N. C.; Chas. Marino, Baltimore; John W. Graves, Danville, Va.; Hanson & Hodges, Covington, Va.; Gilmor-Ham-Snyder, Charlottesville, Va., and Atkinson & Thomas Furniture Co., Southern Pines, N. C.

Baltimore's newest music store, the Brunswick Music Shoppe, was opened on November 26, at 424 South Third street by Charles Marino. This is an exclusive Brunswick store featuring the complete line.

Dealer Uses Clever Plan to Get Live Prospects

Distributes Pencils With Store Ad to School Children Within Wide Radius of Store

Rounding up the elusive prospect! The following method of securing a large list of likely prospects was used by J. E. Duer, proprietor of Duer's Electric Shops at Stoughton and Edgerton, Wis., and resulted in plenty of names for the sales force to follow up. A quantity of lead pencils were purchased with the store's name and the name "Atwater Kent Radio" printed thereon. Mr. Duer then visited every school within a ten-mile radius of the cities in which his stores were located and arranged to give one pencil to each pupil. This was accompanied by a simple questionnaire card upon which was requested "Parent's Name," "Address," "Have You a Radio Set?" and "Pupil's Name." The children readily filled out the cards and Mr. Duer stated that the teachers all gave splendid co-operation.



A Great Columbia Buying Wave!

The sales of our dealers who are stocking, displaying, and playing the new Viva-tonal Columbia and the Columbia New Process Records are mounting in a great buying wave.

This is more than Christmas business—although now's the time to get the Christmas trade, too. The tremendously increased sales are due to the public's recognition of Columbia quality and an insistence upon Columbia products.

Get in touch with us immediately for details

Columbia Wholesalers, Inc.

L. L. Andrews — Wm. H. Swartz

Exclusively Wholesale

205 W. Camden St., Baltimore, Md.

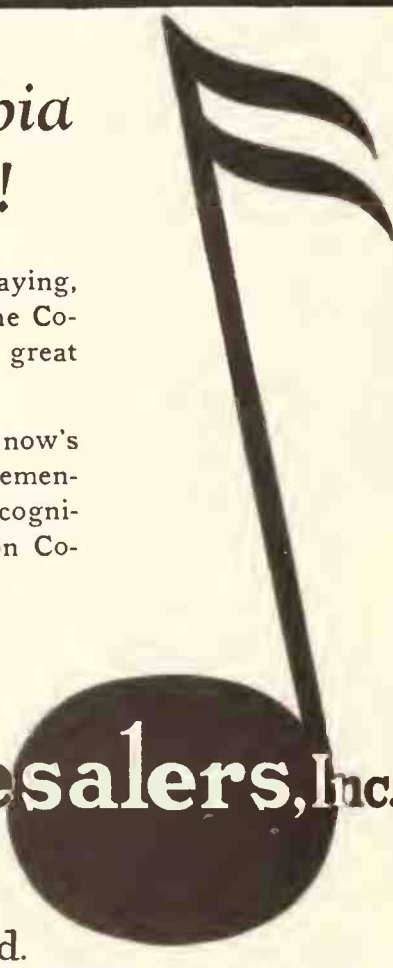

Columbia Graphophone Co., Ltd., Bids for Minority Stock of American Company

Move Is in Line With Progressive Policy of Columbia Graphophone Co., Ltd., of London, of Consolidation of International Interests—Expression of Confidence in the Industry

In line with its progressive policy of a consolidation of international interests, the Columbia Graphophone Co., Ltd., of London, has sent out a notice to stockholders of the Columbia Phonograph Co., Inc., offering to purchase the outstanding minority shares of the Columbia Phonograph Co., Inc., on the basis of either of the following options: (1) the issue by the Columbia Graphophone Co., Ltd., of four of its ordinary 10-shilling shares, valued at 50 shillings and credited as fully paid and non-assessable, for each share of minority stock; or, (2) the payment by the Columbia Graphophone Co., Ltd., of the sum of \$45 for each share of minority stock. The Columbia Graphophone Co., Ltd., owns a controlling interest in Columbia (International) Ltd., a combine made up of the Columbia Phonograph Co., Inc., of New York, the Carl Lindstroem A. G. of Berlin and the Trans-Oceanic Trading Co. of Holland and their subsidiary companies.

Acceptance of the offer by holders of the minority stock is to be made by depositing such stock with Messrs. J. P. Morgan Co., 23 Wall street, New York, as depository of the Columbia Graphophone Co., Ltd. The minority stock amounts to 31,524 shares; the balance, 51,000 shares, is owned by the Columbia (International) Ltd.

The directors of the Columbia Graphophone Co., Ltd., intend asking shareholders to authorize an increase of the capital of the company with a view to carrying out not only this offer but also to enable the company to negotiate for and acquire interests in other companies and thus further consolidate its posi-

tion in the principal markets of the world.

The sales of the Columbia Graphophone Co., Ltd., in the six months ended September 30, 1926, despite the abnormal conditions existing in England due to the coal strike, were larger than in the corresponding period of 1925.

It is considered that the earnings of the various companies for the fiscal year ending March 31, 1928, based upon the present earning power of such companies, should be sufficient to enable the Columbia Graphophone Co., Ltd., to maintain its present dividend rate of 40 per cent (or approximately the equivalent of 76 cents per share after deduction of the English 20 per cent Income Tax) on the increased number of its ordinary shares to be outstanding.

Annual dividends on such ordinary shares (which will be entitled to dividends thereon declared for the next fiscal year commencing April 1, 1927, and thereafter) at the current rate would amount to the equivalent of approximately \$3.04 (free of English 20 per cent Income Tax) for each four shares. The present ordinary shares (entitled to dividends for the current fiscal year if and as paid in ordinary course in December, 1926, and June, 1927) have a market value at current London quotations equivalent to over \$54 for each four shares.

Columbia (International) Ltd. has established recording laboratories, or factories, or both, in every important national market. The United States, England, Germany, France, Italy, Austria, Spain, Australia, Canada, Sweden, Holland, Switzerland, Brazil and the Argentine are so covered. A Pacific Coast factory for the United States has recently been purchased and is now in full production.

ILSLEY'S GRAPHITE PHONO SPRING LUBRICANT

Ilsley's Lubricant makes the Motor make good. Is prepared in the proper consistency, will not run out, dry up, or become sticky or rancid. Remains in its original form indefinitely.

Put up in 1, 5, 10, 25 and 50-pound cans for dealers. This lubricant is also put up in 4-ounce cans to retail at 25 cents each under the trade name of

EUREKA NOISELESS TALKING MACHINE LUBRICANT

Write for special proposition to jobbers

ILSLEY-DOUBLEDAY & CO., 229-231 Front St., New York

This further step in the consolidation of international interests is of especial moment at this time, as the American company, Columbia Phonograph Co., Inc., has just acquired the Okeh and Odeon record business of the General Phonograph Corp.

The directors of the Columbia Graphophone Co., Ltd., are all men whose names are well known in European financial and art circles: Sir George Croydon Marks, C. B. E., is chairman of the board of directors; Michael Herbert, Sir Arthur C. Roberts, K. B. E., H. L. H. Hill, Edward De Stein and James Van Allen Shields are members of the board; Louis Sterling is managing director.

A. D. Silva Elected Vice-President of Farrand Co.

A. D. Silva has been elected vice-president in charge of engineering of the Farrand Co., maker of Farrand speakers and battery eliminators, C. L. Farrand, president, recently announced. Mr. Silva brings to his new post a wealth of experience, having been chief engineer of the Atwater Kent Mfg. Co. for a number of years and having been for ten years connected with the General Electric Co. as transformer engineer. He served as a captain in the Signal Corps during the war and was stationed at the research laboratories in Paris, where he did notable work.



HELYCON

Motors, Tonearms and Reproducers

SUPERIORITY INTERNATIONALLY RECOGNIZED

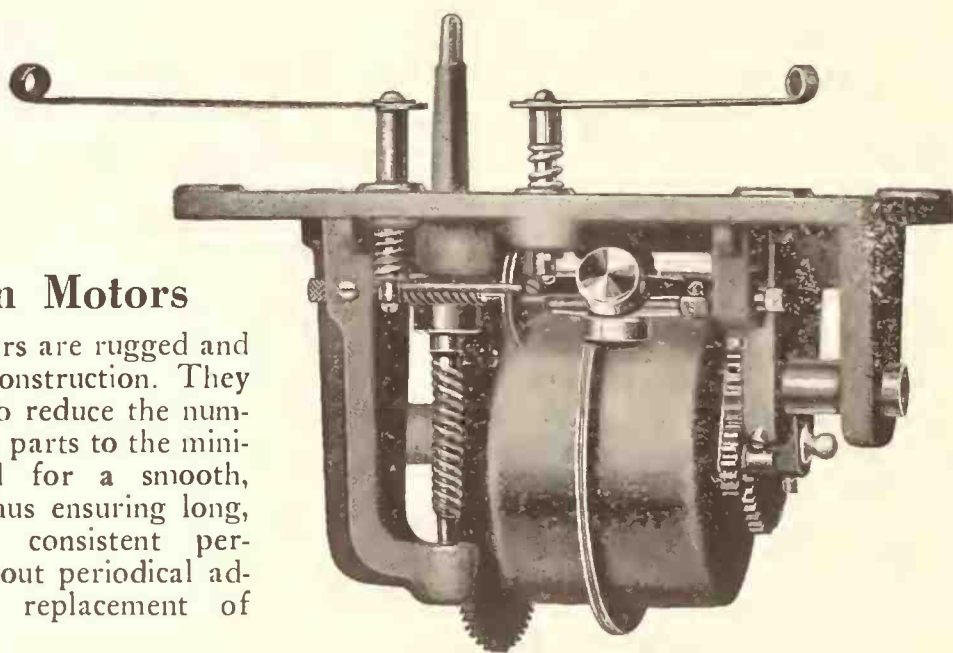

Helycon Motor No. 2

Helycon Motors

Helycon Motors are rugged and substantial in construction. They are designed to reduce the number of wearing parts to the minimum required for a smooth, silent drive, thus ensuring long, constant and consistent performance without periodical adjustments or replacement of parts.

Helycon Motors

The spring barrels can be removed without disturbing the fine adjustment of the motors, and any group of gears can be removed without disturbing any other part. The Helycon Motor is made in four types, with interchangeable parts, to meet every phonograph requirement.

POLLOCK-WELKER, LIMITED

KITCHENER, ONTARIO, CANADA

Established 1907

Cable Address: Polwel, Kitchener.

Code: A. B. C., 5th Edition, Bentley's

Chosen as the Best —By Comparison



MODEL NO. 125

Dimensions: 41½ inches high, 21½ inches wide, 21½ inches deep.

Finish: Mahogany or Walnut—highlighted, with Curley Maple Overlay; Nickel-plated Trimmings.

Equipment: Pathephonic Reproducer and Tone Arm, with 78-inch Solid Wood Amplifying Chamber; Large Double Spring Motor; Automatic Stop; Semi-automatic Lid Support.

[FOUR MODELS]

THE NEW
Pathephonic
REG. U.S. PAT. OFF.



WHY?

Because:

It gives volume and unexcelled music over the entire musical range.

It gives natural reproduction.

All models are equipped with matchless Pathephonic method of amplification.

It is entirely mechanical and easy to operate.

Workmanship and material are unconditionally guaranteed.

It makes even the old type of record sound like a modern recording.



MODEL NO. 275

Dimensions: 49 inches high, 30½ inches wide, 23¼ inches deep.

Finish: Mahogany or Walnut—highlighted, with Crotch Mahogany Overlay; Gold-plated Trimmings.

Equipment: Pathephonic Reproducer and Tone Arm, with 112-inch Solid Wood Amplifying Chamber; Extra Large Spring Motor; Automatic Stop; Automatic Lid Support; Full Set of Record Albums.

PRICE RANGE
(List)
\$125—\$275

These features and others have created big sales for the Pathephonic. However, its biggest feature—fidelity of tone reproduction—cannot be described by words.

"Only your ear can tell you."

Ideal

PHONO PARTS CO. INC.

Write at once for booklet and special discounts. Be first to sell these instruments to your trade who are ready to receive them.

614-16-18 Fifth Ave.
PITTSBURGH, PA.

FACTORY DISTRIBUTORS
Phonographs—Records—Parts—Accessories

1231 Superior Ave.
CLEVELAND, OHIO

The New Type of Phonograph Has Created a Tremendous Demand

*1926 was the introductory year—1927 will
be the big year. How are you going
to meet this demand?*

THE NEW
Pathephonic
REG. U.S. PAT. OFF. 

Answers the Question

Four models ranging in price from \$125 to \$275 give you a diversified line in both price and style and *every model has genuine Pathephonic amplification.*

Are You Cashing in on the Present Demand?

Write today for our catalog which completely illustrates the Pathephonic. Words cannot describe its wonderful tone, however. Send for any model on approval. Hear it in your own store and you be the judge of its merits.

PATHE PHONOGRAPH and RADIO CORP.

30 Grand Avenue

Brooklyn, N. Y.

Chicago Sales Office: 535 So. Wabash Ave., Chicago, Ill.

Formation of Radio and Music Trades Club

Officers Composed of Men All Well Known Throughout the Industry

The recent formation of the Radio and Music Trades Club has aroused considerable interest in the trade and at a recent meeting of the officers and membership committee nearly sixty applications for membership were approved. The next meeting of the club will be held on January 14, at which a very interesting program will be presented, with the idea in mind of providing an entertainment that will give the members an adequate idea of the aims of this new club.

The purpose of the club, as outlined in the by-laws, is "to bring together agreeable per-

sonalities and men of good standing in the trade for the purpose of fostering friendship and the interchange of thought," and at the first meeting, held at the Hotel Pennsylvania a few weeks ago, a representative gathering of radio and phonograph men endorsed enthusiastically the idea of forming an organization of this type. Commercial activities of any kind whatsoever will be banned at the club meetings and membership will be obtained principally by invitation.

The officers of the club are all well known in the industry and include the following: President, George C. Furness, National Carbon Co.; vice-president, Alexander Eisemann, Freed-Eisemann Radio Corp.; vice-president, Max Landay, Landay Bros.; treasurer, Abram Davega, Davega, Inc.; chairman of the board of governors, Ben Gross, Gross-Brennan, Inc. Suitable accommodations for the club in one of the

leading hotels are now being arranged and full details relative to the January meeting will be announced very shortly.

Nick Patti Appointed to Important Sales Post

Will Represent Grigsby-Grunow-Hinds Co. in the Middle West, Southeast and Southwest

CHICAGO, ILL., December 8.—Fred D. Williams, general sales manager of the Grigsby-Grunow-Hinds Co., manufacturer of Majestic "B" eliminators, announced this week the appointment of Nick Patti as a member of the company's sales organization, covering the Middle West, Southeast and Southwest. Mr. Patti is well known in the radio industry, having been identified for some time past with the Freed-Eisemann Radio Corp. and numbering among his friends radio jobbers and dealers from coast to coast. His association with the radio trade dates back many years, and in joining the Grigsby-Grunow-Hinds organization he brings to his new activities a thorough knowledge of merchandising that should enable him to attain signal success with the popular Majestic line.

Big Coast Demand for Columbia McPherson Records

Recordings by World-Famous Evangelist, Aimee Semple McPherson, in Great Demand

SAN FRANCISCO, CAL., December 4.—Talking machine dealers throughout this territory report phenomenal sales of the recent Columbia



Aimee Semple McPherson

coupling, "Come Unto Me" and "I Ain't A-Gonna Grieve," the sermonette and spiritual by Aimee Semple McPherson, the world-famed evangelist, who has appeared in the public prints during the past five or six months to such an extent that there is scarcely a person in this country who is not acquainted with her life and activities as an evangelist.

Oregon Radio Trades Ass'n Nominates 1927 Officers

PORTLAND, ORE., December 1.—At the regular November meeting of the Oregon Radio Trades Association George L. Sammis, manager of the Sunset Electric Co., was nominated for president for the coming year. W. J. Condon, Jr., manager of the L. C. Warner Co., was nominated for vice-president and George J. Thompson, Jr., was renominated as secretary-treasurer for another year. The board of directors for the coming year has been increased from four to eight members, of which four will be strictly retail radio dealers. The following were nominated for directors: H. C. Neigus, H. Freeman, W. Morrison, L. C. Falkenhagen, H. C. Stevens, Vern L. Wenger, F. H. Barstow and Jack Walsh. The annual election and banquet will be held shortly.

Sterling

A great variety of models of

Battery Eliminators

at a wide range of prices!

With Sterling Battery Eliminators you have a number of models under one significantly known brand-name, among which you always have a product to meet each customer's demands—for any set and prices to suit each class of trade.



No. RT-41 "B" Eliminator especially for receivers having 2 to 5 large tubes or more than 5 peanut tubes. Priced as low as is consistent with Sterling high grade performance and dependability. Detector voltage ranges from 0-50 volts; amplifier voltages from 67½ to 135 volts. Using type CX 313 tube.
RT-40 Sterling "B" Eliminator having three terminals—price \$20.00 less tube.
RT-41 Sterling "B" Eliminator having four terminals—price \$22.00 less tube.

We also wish to call your attention to Sterling's comprehensive line of battery chargers made in bulb and vibrating-reed types, open and closed models, also the long established line of Sterling Pocket Meters and Tube Testers. The Sterling meets every Radio buying need.

THE STERLING MFG. CO.
Cleveland, Ohio



Increase
Winter
Sales

With
Sterling
Devices





Reproduction of the original announcement of the Eckharmonic—

Talking Machine World,

November, 1926

Price Complete \$195.00
Less Batteries and Tubes

TO HEAR the Eckharmonic is to enjoy the most faithful reproduction of voice or music yet attained in radio. The new Eckophonic full floating resonator gives to Eckharmonic reception an exquisite organ-like richness and volume which renders with equal fidelity the wonderful depth and roundness of a perfect bass note or the clarity and sweetness of the highest treble. In simplicity of control the Eckharmonic sets a new standard.

ECKHARDT CORPORATION 213 South Broad Street PHILADELPHIA

Instantaneous Success

ONLY last month the Eckharmonic was announced in a color page advertisement in *The Talking Machine World*. Today the radio public may see, hear and purchase the Eckharmonic in the leading cities of the country.

This enthusiastic reception accorded the Eckharmonic by some of the shrewdest and most far sighted radio buyers in America is sufficient indication of the merit of this instrument, which represents the high water mark in the faithful re-creation of voice or music by radio or any other means.

A demonstration of the Eckharmonic will be arranged upon request

ECKHARDT CORPORATION, 213 South Broad St., Philadelphia

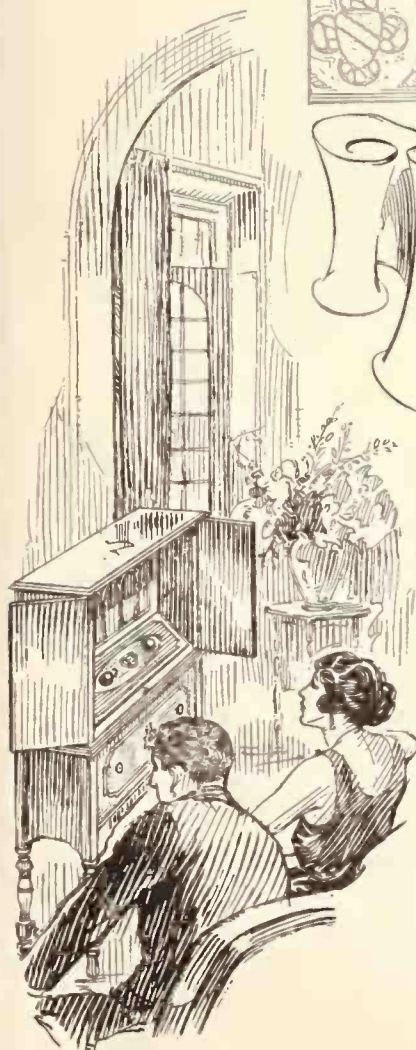

Let Us Help Your 1927 Banjo Sales

November showing of B & D Silver Bell Banjo sales was the largest of any single month in our history

B & D "Silver Bell" Banjos

The Fastest and Easiest Selling Banjo of Today

Also B & D Specialties

B & D Super Banjo
Strings

Felt Grip Picks

Webfoot Banjo Bridges

B & D SUPER
NEVER-FALSE
Gut Strings

For
Banjo (5 String)
Ukulele
and
Guitar



*Let us send you Trade
Prices*



Style No. 1—\$140.00

Style No. 2—\$175.00

Style No. 3—\$250.00

Style No. 4—\$320.00

Style No. 5—\$370.00

Style No. 6—\$450.00

Style No. 7—\$500.00

Style No. 8—\$600.00

JOSEPH PIZZITOLA

Holyoke, Mass.

Director of Pizzitola Strummers. Over WBZ they were the first American Broadcasting Orchestra heard in Germany. Besides his Club work and Teaching, Mr. Pizzitola also has a class of pupils in Northampton among the students of Smith College.

In the photograph above he is shown with his New Style No. 6 Ne Plus Ultra B & D Silver Bell Banjo.

New Revised Lists and Illustrated Half Tones of Leading Orchestra and Professional Players on Request.

THE BACON BANJO COMPANY, Inc., Groton, Conn., U. S. A.

IN THE MUSICAL MERCHANDISE FIELD

National Musical Instrument Mfrs. Offer First of Series of Dealers' Sales Aids

National Association of Musical Instrument and Accessory Manufacturers Prepares Series of Four Newspaper Advertisements for Dealers' Use in Stimulating Sales

CHICAGO, ILL., December 7.—The first of a series of dealer helps prepared by the National Association through the use of a cartoon which shows crowds patronizing a jeweler who advertises,



Drop a Hint

FEW Christmas gifts can give so much real pleasure all the year around for everybody as good musical instruments like the banjo, ukulele, guitar, mandolin or trap drum. Nothing can beat these for modern syncopation. Easy to learn to play!
Organize a club in your home or set. Drop a hint to the folks as to what you would like Christmas!

(Dealer's copy here— with trade marked lines and imprint)



Modern Syncopation

THE popular ukulele, the banjo, the mandolin, guitar and trap drums are the instruments that make for modern music in the home, the school, and the orchestra.

Why not organize a home Syncopation Band? The boy or girl who can play a musical instrument is always popular. Our special plan of instructors will help you. Just a little spare time is required to fit yourself for playing popularity and profit.

Come in any time and investigate.

(Dealer's copy here— with trade marked lines and imprint)



Music in the Home

WISE parents appreciate their responsibility to children and encourage music in the home.

Music entertains and guides youth properly. A musical education is a factor parents should help to encourage and develop. Music is culture. It enriches the home with the most wholesome recreation.

With good string instruments you can have modern syncopation at small cost. Come in and investigate our plan

(Dealer's copy here— with trade marked lines and imprint)

while across the street stands an idle music store. The cartoon also brings out the point that the other music stores are not the dealer's only competitors, but live dealers in other competitive lines must be considered in seeking the public's favor for the product sold. The message with this cartoon reads:

"Newspaper advertising draws the crowds. Advertise in your local newspapers—feature good fretted instruments to attract the crowds. Get your share of the public's dollars that are now going across the street. Sell good music, and with it good fretted instruments.

"Wherever there are people there is a demand for music. In the home, in the school, in clubs, everywhere there is a market for music. Go after it."

One of the advertisements features fretted instruments, two stress orchestra music and the fourth is aimed at parents. The mats can be obtained by dealers from the Association, at 45 West Forty-fifth street, New York

"Harmonica Playing an Art Among School Children"

School Authority States That It Is Becoming Difficult to Select Winners in Contests as All Players Are so Proficient

CHICAGO, ILL., December 4.—"Harmonica playing is becoming an art among school children," states C. H. English, director of the bureau of recreation of the board of education, commenting on the city-wide championship harmonica contest held some time ago at the Harrmons auditorium. "This is the third annual competition," he continued, "and wonderful progress has been made by the young musicians. It was a difficult task for the judges to select the winners, so closely were the leading quartets bunched."

The Mozart Play Ground took first honors in the competition open to boys' quartets as well as the girls' quartets.

Some of the Ads Sponsored by the Musical Instrument Manufacturers Association of Musical Instrument & Accessories Manufacturers to be sent to the dealers has been announced by Walter M. Gotsch, president of the organization. The promotion program being carried out by the Association is aimed toward a greater distribution of musical merchandise that will be profitable to the dealer and that will ultimately benefit the manufacturer. The first material now being distributed consists of four newspaper advertisements stressing "Music" and each bearing an illustration showing the desirability of musical instruments and an idea of the pleasure and happiness which can be gained from playing a musical instrument. In a statement Mr. Gotsch said, in part:

"The membership of the Association aims for the production of quality instruments and recognizes the fact that the so-called unplayable line is very detrimental to the dealers' interests as well as the manufacturers and has a decidedly depressing and discouraging effect on the musical prospect who is trying hard to become a customer and be of value to the dealer in the future. Therefore the interests of dealer and manufacturer are mutual.

"We in the Association hope and trust that the dealers will give careful consideration to the plans that have been painstakingly laid out by the manufacturers. It is only with the dealers' co-operation that we can get anywhere in this matter."

In the message sent to dealers offering them free mats of the advertisements prepared, the value of newspaper advertising is stressed

Musical Instrument Manufacturers

BRUNO

THE OLDEST AND
LARGEST MUSICAL
MERCHANDISE HOUSE
IN AMERICA

Exclusively Wholesale
ESTABLISHED 1834

C. BRUNO & SON, INC.
351-53 FOURTH AVE. NEW YORK CITY

IN THE MUSICAL MERCHANDISE FIELD—(Continued from page 123)

HOHNER Harmonicas and Accordions

THE WORLD'S BEST



Hohner Harmony Hours broadcast from WEAJ and eight allied stations are again creating a heavy demand for Hohner Harmonicas.

Write us for our "Big Business Builders." They will help you.

M. HOHNER, Inc. 114-116 East 16th Street
New York City

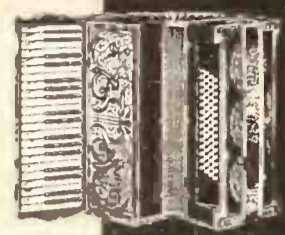

HOHNER PRODUCTS AWARDED FIRST PRIZE AT THE PANAMA-PACIFIC INTERNATIONAL EXPOSITION SAN FRANCISCO 1915

Buegeleisen & Jacobson Issue Holiday Catalog

Supplementary Catalog No. 140, in Addition to Listing Holiday Big Sellers, Gives Diversified List of Year 'Round Items

Buegeleisen & Jacobson, wholesalers and importers of musical merchandise, New York City, have issued a supplementary catalog known as No. 140. This catalog has been compiled, giving special attention to items which have proven themselves best sellers, and in addition to listing items particularly suitable for holiday sale, carries a well-diversified listing of merchandise well calculated to sell the year round. It is believed that this careful compilation will be of much service to the dealer in selecting merchandise for the Winter season. The catalog includes the Durro line of violins, bows and strings, and Stewart banjo mandolins and ukuleles.

H. C. Grothendieck Promoted

CHICAGO, ILL., December 6.—Henry C. Grothendieck, formerly assistant manager of the credit department of Ludwig & Ludwig, Inc., manu-

facturers of drums, banjos and accessories, has been appointed manager of the credit department, succeeding W. J. Barz, who resigned recently. Mr. Grothendieck has been associated with Ludwig & Ludwig for the past seven years.

King Display Holds Interest

NEW PHILADELPHIA, O., December 7.—The interest aroused in the display of King gold-plated band instruments which were sent to the Paul Winters Piano Co., on the occasion of the opening of its salon, was so great that the display was held over for a week longer than was intended. The display consists of saxophones, trumpets, trombones and cornets, finished in heavily plated gold with beautiful silver inlay effects and pearl trimmings.

T. W. Carey Uses Vega Banjo

BOSTON, MASS., December 6.—The Vega banjo, made by the Vega Co., of this city, has been heard on the air quite a bit lately through the playing of Thomas W. Carey on radio station WGN and WLIB, of Chicago. Mr. Carey was recently associated with Gibson, Inc., and was formerly manufacturer of the Carey banjo.

Attributes Big Sales to Co-operation With Schools

Cal D. Fisk, of El Dorado, Kan., Had Excellent Volume of Sales in September Due Mainly to Co-operation With School Supervisors

EL DORADO, KAN., December 6.—An excellent example of the benefits of co-operation with the music supervisors of the public schools in order to increase the sale of band instruments and musical merchandise is the recent experience of Cal D. Fisk, Columbia dealer, who carries a line of band instruments and small goods. During the month of September Mr. Fisk sold seventy violins, fifteen trumpets and a like number of trombones and clarinets, in addition to scattered sales of other musical instruments.

In a town the population of which is in the neighborhood of 11,000 this volume of sales is decidedly satisfactory and Mr. Fisk attributes the major portion of his success to the close harmony with which he works with the music supervisors of the school system. During the past few years, through this method of stimulating sales, Mr. Fisk has, in conjunction with the school authorities, helped organize several bands and orchestras and naturally he profited by sales to members of the newly formed organizations.

Buescher Co. Issues the "Story of the Saxophone"

Band Instrument Manufacturer Tells in Interesting Fashion of the Origin and the Development of Popular Instrument

ELKHART, IND., December 6.—The Buescher Band Instrument Co., manufacturer of Buescher True-Tone saxophones and band instruments, recently issued a booklet of special value and interest to saxophone players and which should also prove useful to dealers in stimulating sales. The title of the work is the "Story of the Saxophone" and it tells the story of the origin and development of the instrument. Another valuable feature included is the beginner's first lesson, a great aid in helping dealers sell the instrument.

The advertising department of the company has also prepared a number of other interesting leaflets dealing with Buescher products, including descriptions of the new octave key for Buescher saxophones, the Snap-on pad, which allows the player of a Buescher saxophone to replace a worn-out pad on his instrument at a moment's notice, the Buescher True-Tone baritone, including five families of baritone horns, several models of basses and a complete list of Buescher accessories.

The NEW SUPER-LUDWIG DRUM

Parallel Snare Throw-Off
Individual Snare Adjustment
Perfect Snare Control

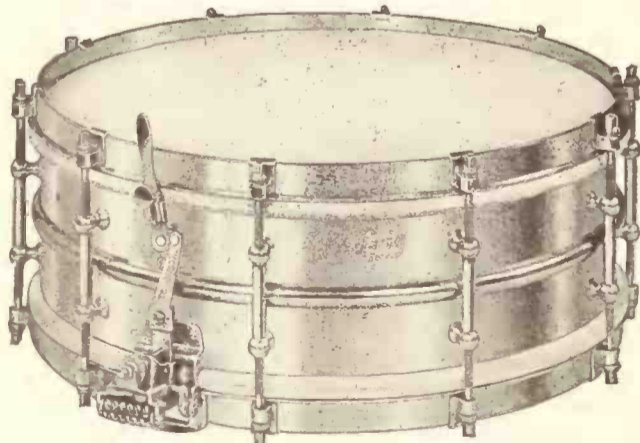

Patd. Jan. 1924 and Others Pending

Send to us Now for Prices and Discounts

LUDWIG & LUDWIG

World's Largest Makers of
Drums and Drum Accessories

1611 to 1627 No. Lincoln Street, CHICAGO

The Sensation of the Drum World

Again Ludwig sets the pace with a new drum—the SUPER-LUDWIG with its many new advanced features.

INDIVIDUAL adjustment of snares, a parallel throw-off of snares and means for securing PERFECT snare control are but a few of the many new improved ideas to be found on this latest creation of Ludwig engineers and craftsmen.

It's a sales leader for the dealer who is on the alert to be up and ahead of the van that will follow.

How Snyder Music Store Conducts Small Goods Department to Bring Big Profits

Wilkes-Barre, Pa., Music Dealer Finds Musical Merchandise and Band Instrument Department a Profit-builder Through the Formation of Community Musical Organizations

Slipshod methods in the operation of the musical merchandise department in many talking machine stores are responsible for lack of profits. Many dealers invest a few hundred dollars in small goods, shove the merchandise in a case and then promptly forget about it. No attempt is made at selling beyond giving attention to customers who come into the store specifically to purchase a small instrument of some kind.

Where the Big Profits Are

Profits from the musical merchandise department in the talking machine store can be made substantial enough to claim the interest of even the most successful dealer. When sales that reach a total of \$1,400 to one organization are reported the argument that there is no money in small goods is puerile, and proves that the dealer who makes it does not know what he is talking about. Take the Snyder Music Store, of Wilkes-Barre, Pa., for example. This concern handles talking machines, musical merchandise and pianos. Its small instrument department has been particularly profitable. Why? Because the executives of that organization realized several things; namely, that the successful operation of a musical merchandise department demands just as intensive and intelligent management as does any other department of the music business. Second, only a man who is familiar with the various instruments and who has the ability to actually demonstrate them can successfully sell them. Third, maximum sales volume requires intelligent sales promotion through education and the dealer must make it easy and interesting to buy and own a small musical instrument.

A Broad and Successful Policy

With these ideas in mind the Snyder Music Store has made its establishment the headquarters in its city for musical merchandise. It has been active in the formation of bands, and at the present time two complete bands and one orchestra meet regularly in the concert hall of the store for lessons. Another band has been formed in Nanticoke and one in Wanamie, Pa. Thompson Rolley, manager of the musical merchandise department, teaches the boys to play the instruments. The interesting and important fact is that every instrument in use by these bands and the orchestra has been purchased from the Snyder store. As has been mentioned, one sale totaled \$1,400. There are about 125 boys in these musical organizations and that means that a similar number of instruments has been sold.

A Building-Up Process

Snyder's Music Store looks further than the mere formation of the bands and the first sales to the youthful musicians, however. The company realizes that as soon as the boys become proficient on the instruments they will be in the market for better ones. Thus the sales pile up. Then, too, the publicity incidental to the formation and activities of the bands has been responsible for a considerable increase in sales.

Clever Financing Plan

Because the store is located in a mining section the firm realized that many of the boys who might be interested in ownership of a small musical instrument could not afford to pay a large sum for the instrument and then pay for lessons. Accordingly, a plan was worked out that makes it possible for a boy to secure a good, serviceable instrument of his choice and get thirty-six lessons, all for the sum of \$46. In other words, the boy selects the type of instrument he desires to play, pays \$10 down and \$1 weekly for thirty-six weeks. During this period a lesson is given each week. Of course, some of the instruments are more expensive

than others, but any inequality in this respect is made up by the lessons received, so that while some boys get more expensive instruments than others and pay the same price, they all are enabled to become a unit in a band or orchestra. If a boy expresses a desire to continue with his lessons after the period of thirty-six weeks a charge of 50 cents per lesson is made.

Real Sales Promotion

The plan in use at the Snyder Music Store can be adopted by any talking machine dealer who is farsighted enough to realize its value. It is merchandising in the larger sense, in that it intelligently copes with a situation that might

retard the profits of the musical merchandise department—the inability of many youngsters to finance the purchase of a small instrument and then pay separately for lessons.

Another factor in the organization of bands and orchestras which might prove interesting to dealers is that in practically every community either individuals or organizations could easily be won over to give co-operation of a moral and financial nature to the formation of a musical organization as a matter of civic pride. It has been pointed out in previous issues of *The World* that town and community bands or orchestras become a factor of the community which leads to positive profits for the tradesfolk of the town and the fact that chambers of commerce throughout the country are lending their support to forming bands is proof positive of the success of such a movement. Let the dealer who is hesitant about starting the movement confer with leading officials and seek their co-operation.



Little Wonder
Special
\$75.00
case extra

SCINTILLATING beauty, rich, superb tone and inherent worth, plus a reputation based upon years of experience as manufacturers of high-grade banjos, are qualities that sell the Vega Special Models. To see them and to hear them is to admire the high quality maintained. Their beautiful, flashy appearance, durable construction and rich penetrating tone give a life time of service to either amateur or professional banjoists.

Write today for further detail on the Vega Special Banjos.

The **VEGA** Co.

Manufacturers of the Famous
VEGAPHONE BANJOS
155-66 Columbus Avenue
Boston, Mass.

IN THE MUSICAL MERCHANDISE FIELD—(Continued from page 125)

Sesqui Harmonica Band Helps Reading Dealers

Appearance of Famous Harmonica Organization Which Was a Feature of the Sesqui-Centennial Celebration a Big Success

READING, PA., December 6.—Although the Sesqui-Centennial exhibition in Philadelphia is officially closed, the popularity of the Sesqui-Centennial Harmonica Band has in no way diminished. This exceptional organization of boy harmonica players appeared in this city at Kaufman's, a big furniture store. The boys made the trip to this city by bus and, although a heavy rain was falling, they found the main streets of the business part of the town well filled with people, who gathered to see this organization which had recently entertained Queen Marie. The Reading papers carried considerable news regarding the band, and the store itself had a full-page advertisement in two newspapers announcing its appearance. It was stated that interest in the harmonica has been greatly increased in Reading since the appearance of this band.

Additions to Vegaphone Banjo Line Announced

BOSTON, MASS., December 4.—The Vega Co., of this city, maker of Vegaphone banjos, has announced several new and improved models in the Vegaphone line. It is stated while the Vegaphone retains its characteristic resonant and powerful tone, the new Vegaphone models embody improvements that give them a more flashy appearance, sturdier construction and simplified means of disassembling for reheading.

In addition to the higher-priced "Professional," "Soloist," "Artist" and "DeLuxe"

Vegaphones, the Vega Co. is placing special emphasis behind two popular-priced models, the "Little Wonder" at the special price of \$75 and the "Whyte Laydie" at \$100. Both these models are equipped with resonators similar to the higher-priced models.

Seiberling, Lucas Music Co. Enters Jobbing Field

Prominent Music Concern of Portland, Ore., Adds New Lines and Issues Comprehensive 130-Page Catalog for Northwest Trade

PORTLAND, ORE., December 4.—The Seiberling, Lucas Music Co. has entered the band instrument and musical merchandise jobbing field and has issued an attractive 130-page catalog, which has been distributed to the music dealers of the Pacific Coast and tributary territory. The catalog is complete in every detail and covers all types of musical instruments.

One of the officials of the company states that the outstanding business is the sale of Hohner harmonicas, due in large measure to the fact that harmonica bands are being organized all over the Pacific Northwest, nearly every school of any size having its harmonica band. Buescher band instruments are also going stronger than ever before, in fact, all of the small goods business is in a better condition than ever before in this territory.

"Harp Week" at Ditson Co.

BOSTON, MASS., December 4.—For a week the latter part of last month "Harp Week" was held at the Oliver Ditson warerooms and there were daily demonstrations of the instrument on the fourth floor of the store where Bernard K. Mather, the Lyon & Healy harp expert, was in charge, supervising the demonstrations and directing the display.

Montana, Cowboy Banjoist, Brings Bacon Publicity

Well-known Vaudeville Headliner, Who Uses and Endorses the Bacon Banjo, Co-operates With Boston Distributing Concern

BOSTON, MASS., December 6.—The recent appearance of Montana, the cowboy banjoist, in this city created considerable publicity for the B. & D. Silver Bell banjo, which he uses and which was made by the Bacon Banjo Co., of Groton, Conn. Montana has been booked several seasons on the Keith Albee circuit and his act consists entirely of banjo playing in a rich costume of pure white buckskin with silk and silver trappings.

He appeared recently at the St. James Theatre, a Keith Albee house in this city, and attracted a large number of banjo enthusiasts to each performance. The St. James Theatre featured his act as a headliner and distributed an interesting circular showing him in cowboy costume. The Musicians' Supply Co., 83 Newberry street, local distributor of the Bacon banjo, tied up nicely with his appearance by inviting the public to its studios on November 19, where Montana gave a special demonstration and lecture.

American Band Instruments Sell in Irish Free State

United States Consul Hathaway Reports That Instruments of American Manufacture Are Preferred to Those of Other Makes

WASHINGTON, D. C., December 4.—There is an increasing demand for American band instruments in the Irish Free State, according to a statement recently received from United States Consul Hathaway, stationed at Dublin, Ireland, who says in part: "The demand for musical instruments of all descriptions has increased noticeably during the past two or three years.

"American band instruments are being sold in the Free State at the present time and, despite higher prices, they enjoy an enviable percentage of the total sales. American instruments are reputed to be of excellent quality and are invariably preferred to other makes when prices are competitive. English, French and German band instruments have also found a market in the Free State and compete actively with those of American manufacture because of the relatively low price at which they may be bought."

Ninety-second Catalog Issued by Bruno & Son

Well-known Metropolitan Distributing Firm Issues for the Ninety-second Year a Complete Listing of Products It Jobs

The annual catalog of C. Bruno & Son, Inc., wholesalers of musical merchandise, 353 Fourth avenue, New York, was recently distributed to the metropolitan trade. The new catalog is the ninety-second annual listing of the products distributed by the firm, and is a striking tribute to the growth and achievements of the company. It has been prepared under the personal direction of Charles Sonfield, general sales manager of the firm, who spent several months in preparation and supervising the compilation of the data.

Included in the listing appears practically every known article of musical merchandise, for the Bruno organization carries as complete a line as can be found. There are a number of special color pages that are extremely attractive and the entire book is worthy in content and appearance of representing the long-established house of Bruno.

A Holiday Catalogue

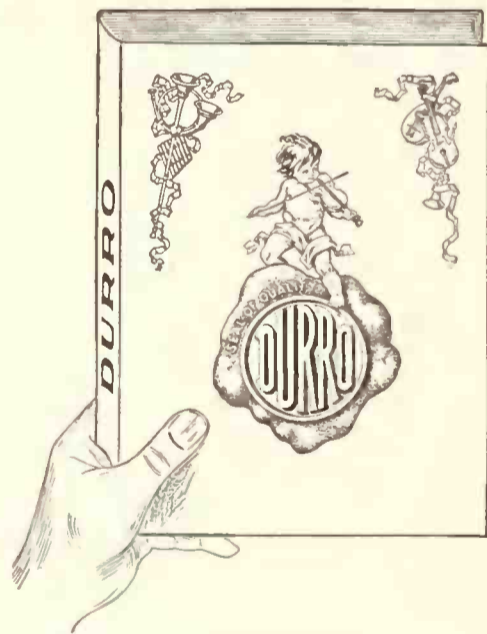

The New B & J Supplementary Holiday Catalogue

A new 60-page supplementary catalogue No. 140, brimming full of Holiday goods, and well-known, popular lines, is now being distributed to the trade.

It's different. Because in it are listed:

- (1) Numbers in every branch of Musical Merchandise, which have proved themselves to be the "best sellers" throughout the country for the past year.
- (2) New items from both Europe and America, showing the latest changes, and listed at the latest prices.
- (3) Discontinued lines at a genuine saving of 15 to 25 per cent.

If you haven't received a copy, send for it today.

BUEGELEISEN & JACOBSON

5 Union Square

(Wholesale Only)

New York, N. Y.

The Weymann Orchestra Banjo



FRED C. BUCK
Banjoist
Waring's
Pennsylvanians

Has won for itself the endorsement of banjoists the country over! Its fine tone qualities, its beauty—have created an unparalleled demand for this instrument.

Write TO-DAY for handsome catalog describing the Weymann line of Banjos, Mandolutes, Guitars and Ukuleles. Agencies are still available for a few live dealers.

Address Dept. W

H.A. WEYMANN & SON, Inc.
1108 Chestnut St. Phila., Pa.

Resume Broadcasting of Hohner Harmonica Concerts

Tremendous Success Which This Activity Experienced in Former Years Warrants the Resumption—Acclaimed by Daily Press

M. Hohner, Inc., New York City, maker of the Hohner harmonica, is again sponsoring harmonica programs over station WEAF and its allied stations. The tremendous success with which the broadcast hours have been received in past seasons well warrants its resumption this year. In addition to instruction upon the playing of the harmonica by William J. Haussler, vice-president and general manager of the company, a number of selections are rendered by boys proficient in the playing of this instrument. Advance notice of the various programs has been appearing through advertising space in the daily papers and following the program many favorable reviews of the hour have appeared in the press. The New York American interestingly described the real music that the harmonica offered and summed up a long article by saying "The diversion afforded one of the evening's different niceties."

Beginning with the initial program on November 19 the Hohner Harmony Hour will be broadcast every other week on Friday evenings at 8:30 until January 31.

The Hohner harmonica is also a featured number of a new vaudeville act known as "The Ingenues," a clever act with nineteen girls, which opened in Chicago.

Interesting Leedy "Topics"

The November issue of Leedy Drum Topics, published by the Leedy Manufacturing Co., Indianapolis, Ind., maker of drums and drummers' accessories, contains, as does every issue,

"HYGRADE"

Musical Instrument Cases

Made of Three-ply Veneer

We also manufacture All Types of Portable Phonograph and Radio Cases and Boxes

Send for Our Price List!

HYGRADE CASE CO., Inc.

Manufacturers of

"Hygrade" Musical Instrument Cases
Sold by All Leading Jobbers

345-347 South 6th St. Newark, N. J.

a wealth of news about drummers from all over the world with attractive illustrations of leading Leedy exponents and commendations of Leedy products by famous musical authorities. This issue also contains several hints to drummers to aid them in producing new and better effects.

Contests at Convention

SAN FRANCISCO, CAL., December 3.—A number of excellent band contests marked the Sciots convention at Santa Cruz, states E. J. Delano, manager of the retail small goods department of Sherman, Clay & Co., here. Mr. Delano conducted the Alameda Sciots' band, which had a lady trombonist. The majority of instruments in this band, as in many of the others in the competitions, were King instruments, made by the H. N. White Co., of Cleveland, O., a strong tribute to the popularity of the line.

Award Harmonicas as Prizes

FRESNO, CAL., December 3.—In a drive for subscriptions, one of the local newspapers, the Fresno Republican, offered harmonicas as awards in stimulating school boys and girls to solicit subscriptions for its publication. They reported success in the campaign, distributing upwards of 150 harmonicas in three weeks in lieu of cash commissions for subscriptions.



G. A. Hausner

G. A. Hausner

Proprietor, Hausner Music Co. of Mpls. & St. Paul,

says—

"Being an exclusive musical merchandise dealer I naturally make the line of each department prove its worth. My drum division is one of the strongest lines in both stores and one of my chief hobbies as well. I can whole-heartedly state that the Leedy brand and the company behind it have proven to be a great boon to my business. The dealer wants results. That is what I am getting with Leedy and I can safely recommend it to others."

And, over sixteen hundred other dealers are getting results with Leedy—Are you one of them? If not, get in touch with us—

Leedy Mfg. Co.

Indianapolis,
Indiana

"The Only Complete Drum Line—By One House"

Columbia Phonograph Staff Holds Annual Luncheon

Personnel of Columbia Phonograph Co. Headquarters Gather at Hotel McAlpin for Annual Festivities—Record Stars Entertain

The annual luncheon and dance of the employees of the Columbia Phonograph Co., Inc., New York, was held the latter part of last month at the Hotel McAlpin and was voted one of the most successful of these yearly celebrations. During the luncheon many of the artists who make Columbia recordings entertained, with Irving Kaufman in the role of master of ceremonies. Among those who kept the party in gales of laughter were Billy Jones and Ernest Hare, the Happiness Boys; Jack Kaufman and Al Campbell, Jack Glogan, Frank Banta and Nathan Glantz and His Manhattan Merrymakers, who provided the dance music for the occasion. Johnny Marvin and His Uke made a special trip from the show, "Honey-moon Lane," in which he is starring.

Among the Columbia Phonograph Co. officials and department heads who attended were: Mr. and Mrs. Louis Sterling, Mr. and Mrs. H. C. Cox, Mr. and Mrs. Frank Dorian, Mr. and Mrs. T. Allan Laurie, Mr. and Mrs. J. S. Macdonald, Mr. and Mrs. Arthur Bergh and Geraldine Bergh, Mr. and Mrs. Frank B. Walker, Mr. and Mrs. Ed. King, Mr. and Mrs. W. A. Forbush, Mr. and Mrs. E. B. Shiddell, Mr. and Mrs. J. P. Bradt, Mr. and Mrs. George Drolett, Mr. and Mrs. H. C. Brown, A. W. Roos, Ed. F. Sause, A. Thallmayer, J. M. Lacalle, George C. Jell, R. T. Freibus, F. N. Sard, H. W. Clock. Other guests were Joe Davis, Ben Bornstein, Ed. Christie and Frank Capps.

Ray Barker, as chairman of the arrangements committee, received many congratulations upon the staging of the affair. Assisting Ray Barker on the committee were the Misses Marguerite N. Fleming, Louise Obermeyer, Estelle Finnegan, Edna M. Sias, Lillian M. Morgan, Mildred Sabarra and Jane Thompkins.

A music and radio store, the Aztec Music & Electrical Co., was opened recently at Aztec, N. M. The proprietors are Mrs. Guy Herbert and Mrs. Harold Herbert.

Protect your set /
BIRNBACH·BATTERY·CABLE

Simplifies the connecting of Radio Batteries
SEPARATE COLORED WIRES

5 Conductor Cable with Soldered Terminals 50¢

Also made in 6-7-8 WIRE CABLES for the NEW POWER TUBES

Improve your reception
by placing Your Loud Speaker any distance from your Receiver

BIRNBACH
20ft. Extension Cord with Connector \$1.00
And 30-40-50-100 foot units

BIRNBACH RADIO CO.
370 SEVENTH AVE. NEW YORK CITY

L. H. Mingens Elected President of Garod Corp.

Leicester H. Mingens, of the Twentieth Century Radio Corp., recently was elected president of the Garod Corp., Main and Mill streets, Belleville, N. J., succeeding I. P. Rodman.

Mr. Mingens has been an active factor in the radio field for a number of years and has successfully operated for the past few seasons the Twentieth Century Radio Corp., a prominent New York wholesale distributing company.

The Twentieth Century Radio Corp. is distributor of "Garod Electric Power" receivers and Mr. Mingens' interest in the possibilities of this product led him to accept a more prominent position in the affairs of the Garod Corp.

President Coolidge Urges Speedy Radio Legislation

WASHINGTON, D. C., December 7.—President Coolidge, in treating of the radio broadcasting situation, in his message to Congress, took a definite stand, declaring that "the authority of the Department of Commerce has broken down—and the whole service of this most important public function has drifted into such chaos as seems likely, if not remedied, to destroy its great value" and urged that radio legislation speedily be enacted.

Fada Sales Gain 15 Per Cent

November sales of Fada radio were 15 per cent higher than the October total, according to an announcement made by Frank A. D. Andrea, president. In October \$2,500,000 in Fada sales were announced, thus bringing the November total not far from the \$3,000,000 mark. Mr. Andrea stated that November sales were the largest in the history of the company and were twice the volume sold in November, 1925. December, with the Fada factory running at full capacity, is expected to be another record-breaking month, Mr. Andrea declared.

The Angelus Music Co., San Pedro, Cal., recently added a radio department carrying a full line of receivers and accessories.

"Super Ball" Antenna

10,000 Dealers
Now Stocked



Dealers Report
Quick Sales

Every radio user needs the Super-Ball Antenna—they will buy on sight if you display this item. This means easy sales,

good profits and satisfied, boosting customers. Complete details upon request. Order from your jobber—today.

YAHR-LANGE

MILWAUKEE, WIS. INCORPORATED DETROIT, MICH.

Celebration Features Production of the Millionth Atwater Kent Receiving Set

Six-Tube, Single-Dial, Shielded Metal Cabinet Set Was Millionth Turned Out at Huge Atwater Kent Plant—Moving Pictures, Banquet and Entertainment Part of Festivities

PHILADELPHIA, PA., December 8.—The millionth Atwater Kent receiving set was turned out here at 4 o'clock this afternoon. It was a six-tube, single-dial set, in the latest shielded metal cabinet. Simultaneously, A. Atwater Kent made public his company's production figures for the past four years, showing that the current year (May 1-April 30, 1926-27) will record an output of more than 600,000 sets against 6,628 for 1922-23, the first year's record.

Mr. Kent himself gave the millionth set its final test upon its completion this afternoon in the presence of thousands of employes, friends and distinguished visitors to the Atwater Kent factories. Upon the completion of the inspection Mr. Kent was congratulated and in turn

congratulated the various members of his staff. Addressing his officers, employes and friends, Mr. Kent said:

"It is difficult for me to find words with which to express my pride and gratification in this moment. I feel as if I wanted to hup-hurrah. I want to throw my hat up in the air. I am happy in the knowledge that you feel the same way about it and I am deeply grateful for your loyal, enthusiastic co-operation, which has made this achievement possible.

"The millionth set means not only that we have grown to manhood in our industrial and commercial life, but that we have built together, during the rapid activities of the last four years, a harmonious, self-respecting family of co-

workers who are making the world a better place in which to live. Our material success has not taken toll of society, but, rather, has contributed to the happiness, comfort and benefit of society. Greater opportunity for service confronts us in the future. The drama of to-day, in which we have seen the millionth set produced, opens even wider opportunities for to-morrow.

"With your splendid loyalty and co-operation



A. Atwater Kent and the "Millionth Set"

There is also shown the first Atwater Kent radio part and the first complete set. In the background is a group of Atwater Kent executives

I face it happily, confident that it will find us ready and able to measure up to the obligations which to-day's events have placed upon us."

In direct contrast with the latest set was shown the first Atwater Kent set and also the first radio part, the forerunner of the first set. An appropriate plate was placed upon the set and it will remain on exhibition at the factory.

Further work in the factory was abandoned for the day and the afternoon celebration included orchestral music and community singing. The entire proceedings of the afternoon were recorded not only by still pictures but by continuous motion picture photography as well. In the evening five hundred office and factory executives were the guests of Mr. Kent at a dinner tendered them at the Mercantile Club in this city. Sales Manager V. W. Collamore presided and in referring to the accomplishment and the production of the millionth set compared it to the decade or more that big manufacturers in other lines had taken to turn out their millionth product. Mr. Kent again spoke to his co-workers, who had helped him accomplish this feat. Following Mr. Kent's speech Dr. E. J. Cattell, prominent after-dinner orator of Philadelphia, spoke on the altruistic side of the production of the radio set. Honor was paid to Mrs. A. Atwater Kent, who was with her husband at the speakers' table, by the presentation of a bouquet from the office and factory staff.

The day not only commemorated the production of the millionth set but was the birthday anniversary of Mr. Kent as well. This was remembered by his staff through expressions of congratulation and the presentation of a mammoth bouquet.

Following the dinner entertainment was provided by a number of vaudeville acts which were turned out to-day.

During the current year the Atwater Kent factory has had to be expanded rapidly to meet increasing demands, until a production of more than 5,300 receiving sets per day has been reached. It was announced this afternoon that, in addition to the millionth set, 5,317 other sets were turned out to-day.

The millionth set will be retained here for exhibition at the plant, but the first hundred sets of the second million, completed immediately following the millionth set, are being shipped personally to distributors for their retention. They are exact duplicates of the millionth set and each is marked with a gold plate on which its number is certified over Mr. Kent's autograph.

Dealer tie-up with this auspicious event was provided by two window display cards which were furnished by the Atwater Kent Mfg. Co. The first one read as follows: "The first receive-

(Continued on page 130)

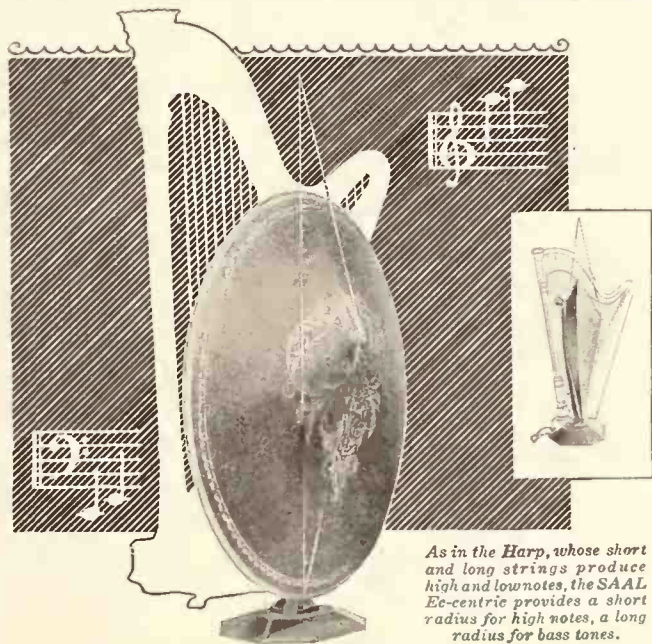

As in the Harp, whose short and long strings produce high and low notes, the SAAL Ec-centric provides a short radius for high notes, a long radius for bass tones.

Ec-centric The big, new cone Speaker Idea



The SAAL Pedestal is an ornament to the most beautiful surroundings. Its pure wooden tone chamber, three feet in length, gives exceptionally clear mellow reception. Price, \$38



The famous SAAL Soft Speaker, the outstanding speaker of its type. Its giving satisfaction regardless of the set or equipment used. Standard with radioengineers. Price, \$22.50

On the principle of the harp, whose short strings produce the high treble notes, whose long strings give forth the deep bass tones, the Saal-Ec-centric, with its "center" actually off-center, provides a short vibrating radius for the high notes, a long radius for the rich low tones.

These exact relative proportions of vibrating area, definitely fixed by scientific principles, are now provided for the first time in the Saal Ec-centric Cone. All rumble or "barrel tone" is eliminated. True balanced tone from soprano, flute and violin to pipe organ or 'cello. A demonstration will convince you.

Hear the Saal Ec-centric at your dealer's, or write us to direct you where it can be heard.

The Saal Ec-centric comes in two models: 20-inch, \$25; 14-inch (Junior), \$15. Slightly more west of Rockies.

SAAL

H. G. SAAL COMPANY, 1800 Montrose Ave., Chicago, U. S. A.

BLUE RIBBON RADIO TUBES

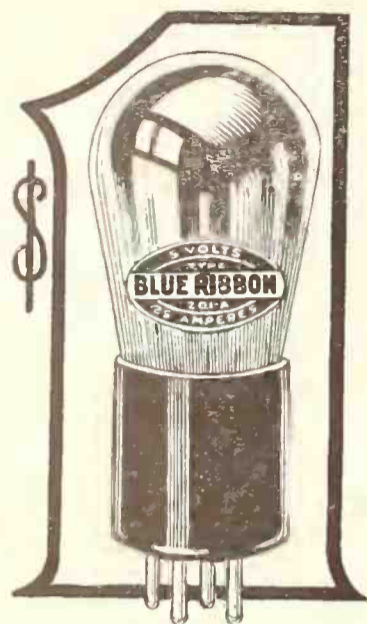

THE DOLLAR TUBES

Guaranteed equal in every respect to the standard tubes selling for twice the price.

Mr. Jobber: put your dealer on a competitive basis with the Syndicate and chain stores who have reaped a huge harvest selling Dollar Tubes. Offer him a real leader, something that will bring the crowds to his store.

BLUE RIBBON TUBES sell quickly and stay sold. They are built by the pioneer manufacturers of independent tubes. The best engineering skill, experience and knowledge gained from years of specialization are incorporated in their manufacture.

Every BLUE RIBBON tube is absolutely guaranteed against all defects—no arguments—no reservations—Defective tubes are replaced without charge.

NOTE: Don't class the BLUE RIBBON TUBE with the ordinary dollar tube which is usually a factory second or reject. BLUE RIBBON TUBES are a distinctly quality proposition.

200A, Detectors, 112 and 171 Power Tubes at Greatly Reduced List.

Tectron Radio Corp.
1270 Broadway New York, N. Y.

Atwater Kent Mfg. Co. Produces Millionth Set

(Continued from page 129)

ing set sold by the Atwater Kent Mfg. Co. was shipped from the factory in November, 1922. Figures for the intervening years showing the increasing demand for Atwater Kent sets are: 1922-1923, 6,628; 1923-1924, 58,927; 1924-1925, 175,461; 1925-1926, 331,208. Production of sets for 1926-1927, 600,000."

The second one which was to be used in conjunction with the display of the Atwater Kent model in shielded metal case read: "This is a duplicate of the 1,000,000th radio receiving set made by the Atwater Kent Manufacturing Co. in its fifteen-acre factory at Philadelphia, Pa., on Friday, December 3, 1926. On the same day 5,317 sets (eleven per minute) were completed."

Daven Radio Corp. Purchases the Port Mfg. Co.

Plans Production of New Six-tube Set Embodying the "Davin Bass Note Circuit"

The Daven Radio Corp., 158 Summit street, Newark, N. J., has purchased outright the Port Mfg. Co. This latter concern for over a year has been making what has been termed a "Bass Note" set under a license from the Daven Corp.

W. H. Frasse, president of the Daven Radio Corp., in making the above announcement, stated that his company would enter into the production of a Daven six-tube set embodying the "Daven Bass Note Circuit." Over two thousand of the "Bass Note" sets have been in the hands of consumers for the past twelve months. It is the success attained by these sets that resulted in the decision of the Daven Corp. for the purchase of the Port Co. and the further extension of the manufacture of this equipment.

The Daven Radio Corp. are pioneers in the manufacture of radio apparatus, specialists in resistor products and are the developers of the "Daven Super Amplifier" and radio tubes.

Seeking New Legislation Covering Postal Activities

WASHINGTON, D. C., December 6.—Restoration of the 1-cent rate of postage for private mailing cards, together with legislation under which the postage on private reply cards could be collected upon delivery, is recommended by the Postmaster General in his annual report, submitted this week to the President. Other recommendations call for legislation under which an additional charge of 1 cent per ounce would be assessed on first-class mail matter short-paid to the extent of more than two cents; graduated charges for the special handling of parcels, which would cut the fee to 15 cents on parcels not over two pounds in weight, and increase it to 35 cents for parcels weighing over ten pounds; the imposition of fees on inquiries concerning registered, insured and collect-on-delivery mail; the issuance of receipts for ordinary mail upon payment of a fee; the automatic return to the sender of C. O. D. parcels not accepted by the addressee within a specified period; the extension of C. O. D. service to first-class parcels, and extension of the registry service so as to provide indemnity for mail up to a value of \$1,000.

World's Classified Advertising

Any member of the trade may forward to this office a "Situation" advertisement intended for this Department to occupy a space of four lines, agate measure, and it will be inserted free. Replies will also be forwarded without cost. Additional space will be at the rate of 25c per line. If bold-faced type is desired the cost of same will be 25c per line. Rates for all other classes of advertising on application.

SITUATION WANTED—By an ex-chief patent counsel and engineering consultant of large phonograph corporation; now in private practice to represent other phonograph or radio interests, in patent, trade-mark, or miscellaneous contract matters, or as engineering expert in acoustics. Address "Box 1586," care of The Talking Machine World, 383 Madison Ave., New York City.

POSITION WANTED—Radio Sales Manager of nationally known radio manufacturing concern desires to represent some prominent concern requiring Pacific Coast manager. Applicant has splendid record in radio industry as sales executive. This is an opportunity for growing concern willing to pay a bonus for large sales that will lead to a slow but healthy national distribution. Address "Box 1587," care of The Talking Machine World, 383 Madison Ave., New York City.

FOR SALE

500-1000 Atwater Kent Model-20 Compact Cabinets. Perfect Condition. Immediate Delivery.

WHAT AM I OFFERED ?

FRED'K P. ALTSCHUL,
6 East 14th St., New York City

Established Business for Sale

A good-paying Victrola and radio business, ideally located in Scranton, Pennsylvania. Established for ten years. Franchises for selling Victrolas and records; RCA radiolas; Atwater Kent radio and radio accessories. Owners have excellent reason for selling. Immediate sale desired. Address "Box 1585," care The Talking Machine World, 383 Madison Ave., New York City.

FOR SALE

Only exclusive music and radio store. City of 10,000. Division point main line Santa Fe. Established 27 years. Pianos, phonographs, radios and general stock. Competition negligible. Central location. Reasonable rent. About \$8,000 will handle. Can reduce. Bear investigation. Illness cause of selling. Address Newton Music Co., Newton, Kans.

SPRINGS

VICTOR

1 1/4"x.022x17', bent each end.....	No. 6543	\$.57
1 1/4"x.022x18' 6" marine ends.....	No. 3014	.57
1 1/4"x.022x17' bent arbor.....	No. 5362	.56
1 1/4"x.022x13' bent arbor.....	No. 5423	.48
1 1/4"x.022x9' bent arbor.....	No. 5427	.38
1 1/4"x.022x9' bent each end.....	No. 6542	.38
1"x.020x13' 6" marine ends.....	No. 2141	.35
1"x.020x15' marine ends.....	No. 3335	.38
1"x.020x15' bent arbor.....	No. 5394	.39
1"x.020x15', bent at each end.....	No. 6546	.39

COLUMBIA

1"x.028x16' crimp arbor, new style.....	No. 20009	.61
1"x.028x10' Universal.....	No. 2951	.32
1"x.028x11' Universal.....	No. 2951	.38
1"x.030x11' hook ends.....	No. 5394	.40
1"x11' for motor No. 1.....	No. 1219	.34

HEINEMAN

1"x.025x12' motors, Nos. 33 & 77.....	No. 33 & 77	.35
1 3/16"x.026x19', also Pathé.....	No. 4	.70
1 3/16"x.026x17'.....	No. 4	.60

SAAL-SILVERTONE

1"x.027x10', rectangular hole.....	No. 144	.39
1"x.027x13', rectangular hole.....	No. 145	.45
1"x.027x16', rectangular hole.....	No. 146	.53

Terms, 2 per cent cash with order.

TALKING MACHINE SUPPLY CO., PARK RIDGE, N. J.
Complete catalogue on request

An entire eight-page section of a recent issue of the Rochester, N. Y., American was devoted to a history of the growth of the Chapin-Owen Co., Crosley distributor.

CONSTANTLY INCREASING SALES

are testifying to the superior quality of our

COTTON FLOCKS FOR PHONOGRAPH RECORDS

STEP INTO LINE WITH THE BUYERS OF "QUALITY"

CLAREMONT WASTE MFG. CO., Claremont, N. H.

San Francisco Mayor Presented With A. K. Set

Mary Lewis, Star of Metropolitan Opera Company, Makes Presentation

SAN FRANCISCO, CAL., December 8.—Mayor Rolph, of this city, was recently presented with a duplicate of the millionth radio set produced in the factories of the Atwater Kent Mfg. Co. in Philadelphia. The set was presented by Mary Lewis, star of the Metropolitan Opera Company, in behalf of A. Atwater Kent and in the presence of Ernest Ingold, of Ernest Ingold, Inc., Atwater Kent distributor of this city.

Mayor Rolph expressed his appreciation in a letter addressed to Mr. Kent which he closes by stating: "Please accept my congratulations upon all you have achieved in the radio world, and every good wish for greater development in the years to come."



Complete Assembly for a 6 Tube Resistance Coupled Single Dial Receiver

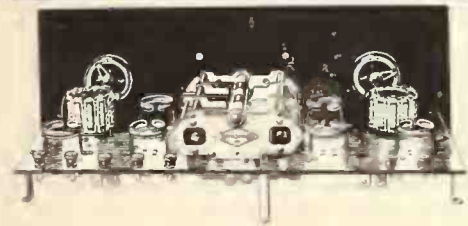

Approved Everywhere!

Talking Machine and Music Dealers everywhere throughout the country have enthusiastically approved of Pierce-Airo because it is a proven good seller and is making money for them.

Pierce-Airo is a mechanically and electrically perfect product. It fits all standard cabinets and consoles now on the market. Pierce-Airo meets the season's demand for simplicity of operation and purity of tone by scientifically combining single-dial control and resistance-coupled amplification. No live dealer can afford to overlook this unusual opportunity. Let us quote on your requirements TO-DAY.

Pierce-Airo Complete Assembly with a 7x18 Processed Bakelite Panel, Ready for Wiring.

LIST PRICE \$42.50

**Pierce-Airo Chassis Wired, \$45.00
UNITED SCIENTIFIC LABS.
80 Fourth Avenue, New York City**



Branch Offices

CHICAGO
BOSTON
MINNEAPOLIS

PHILADELPHIA
LOS ANGELES
SAN FRANCISCO

NEW!

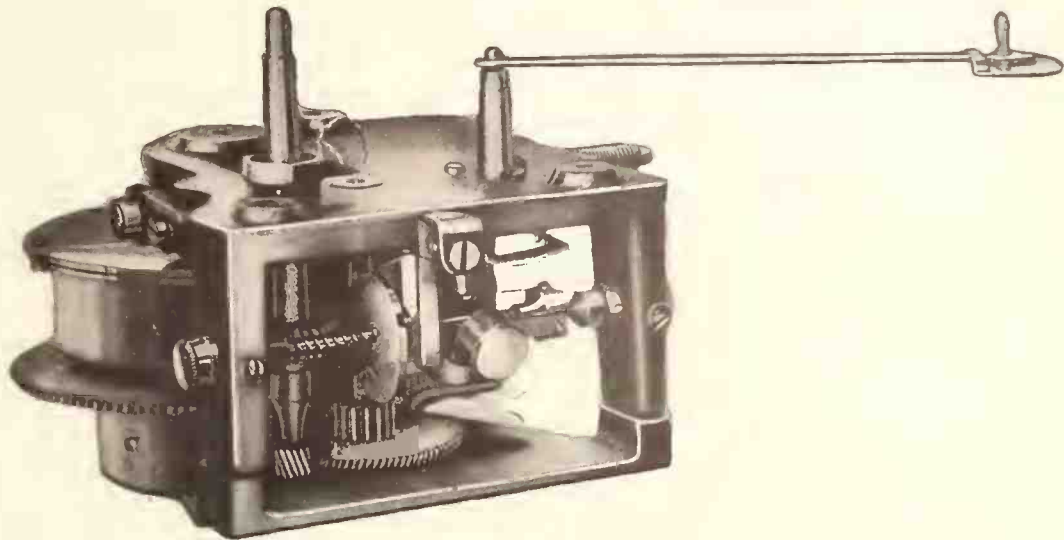

Model DS

Announcing the Newest Member of the SILENT MOTOR FAMILY

Model DS plays five ten-inch records with one winding. Incorporates all the famous features that have distinguished the Silent Motor—the best built motor on the market.

Costs no more than the ordinary three record motor. Furnished with twelve-inch turn table and large winding crank.

FULLY GUARANTEED

Orders are coming in fast. Let us know your requirements before our production reaches full capacity.

Silent Motor Corporation

HERMAN SEGAL, President

321-323-325 Dean Street

Brooklyn, N. Y.

Pathé Co. Busy

All departments of the Pathé Phonograph & Radio Corp., Brooklyn, N. Y., are reported active this Fall season. The volume of record business has been exceptional. Although the new Pathéphonic reproducing instrument has only been on the market a little over four months its sales total has reached a large figure. The demand is well distributed throughout the entire four models of the line. The reception accorded this new instrument the early part of the year has well warranted intensive efforts being placed behind it for 1927. Indications point to a year of prosperity for the Pathé Phonograph & Radio Corp.

David Sarnoff Delivers Talk

David Sarnoff, vice-president and general manager of the Radio Corp. of America, in an address on "Uncharted Roads of Radio Development," delivered before the St. Lawrence University, Canton, N. Y., December 10, declared that the air will be the future laboratory of radio development and that the greater service which radio envisages is in the hands of the electrical scientists now being trained in American universities. Mr. Sarnoff also discussed in considerable detail some of the technical problems of radio, and talked at some length on the need of adequate regulatory radio broadcasting legislation.

COTTON FLOCKS

Air floated, all injurious foreign matter eliminated for

**Record and Radio Manufacturing
THE PECKHAM MFG. CO. 238 South Street
Newark, N. J.**

MICA DIAPHRAGMS

For Loud Speakers and Talking Machines
RADIO MICA

**American Mica Works
47 West Street New York**

Profits of Victor Talking Machine Co. Are \$5,648,446

Report of Business for the Nine Months Just Closed Indicates That Business This Year Is the Biggest in Firm's History

CAMDEN, N. J., December 9.—The greatest profit in its history has been made by the Victor Talking Machine Co. in 1926, according to a report just issued. The company was sold to Speyer & Co. and J. & W. Seligman & Co., this week, complete details of which appear in another section of this issue of The World. Its statement shows the net profit for the first nine months of the year to have been \$5,648,446.26. This is an average of nearly \$1,900,000 a quarter.

If the same rate of earnings has been maintained in the last quarter, and it is said there is every indication that it has, net profits for the year will reach \$7,500,000, or more than \$21 a share on the 348,863 shares of common stock outstanding.

Attached to the statement are the balance sheets of September 30 and June 30, 1926. A comparison of the two shows that during the third quarter of the year ending on September 30 the increase in surplus, equivalent to net earnings, was \$2,368,659.30, a much higher rate than during the first half of the year. At the same time cash and marketable securities increased \$2,224,833.62, from \$10,196,081.94 on June 30 to \$12,620,915.56 on September 30. Ready assets are more than four times the liability of the company.

The book value of the stock as shown on the balance sheet of September 30 is \$113 a share, but the patent rights and record matrices are carried at the nominal value of \$1, while goodwill does not appear among the assets. Computing these items on the present earnings of the company, they would have a value of \$60,000,000. This figure is arrived at by capitalizing earnings of \$7,500,000 at 12½ per cent, which is the measure usually adopted by Federal officials in fixing the value of a going business for inheritance tax purposes. This would add \$170 to the book value of the stock and make its present real worth \$283 a share.

Strong Demand for Argus

The popularity of the electric radio receiving set is strong, as is proved by the heavy volume of orders being received by the Argus Radio Corp., New York City. Both the manufacturer and distributors are cooperating intensively in Argus sales, and Ira Greene, treasurer of the Argus Radio Corp., reports that the sales figure for this year will greatly exceed even the high expectations of the officials of the company when larger manufacturing facilities were obtained last July. The outlook for the new year for Argus radio is exceptionally bright, according to indications.

Radio Dealers Within the Wholesale Range of Baltimore

When in doubt or trouble about problems of the radio business, generally consult—

COLUMBIA WHOLESALERS, Inc.

because of their fine technical staff and efficient service. We not only sell the best in receivers and accessories, but exert every effort to help move merchandise for the retailer. Our name to most dealers means dependability and the closest co-operation—ONLY THE BEST—REGARDLESS OF COST IS OUR SLOGAN.

FADA	PHILCO	BALKITE	TOWER
CROSLY	MAJESTIC	BRACH	BRANDES
MOHAWK	TIMMONS	BURGESS	DEFOREST
	PATHEX		

COLUMBIA WHOLESALERS, Inc.

205 W. Camden Street

Baltimore, Md.

New Broadcasting Firm Buys the Grebe Stations

A new broadcasting company has been formed which has purchased the Grebe group of broadcasting stations, including the 5,000-watt transmitting equipment of station WAHG and the 500-watt set of WBOQ. The new company will be known as the Atlantic Broadcasting Corp. and will use the call letters WABC. The offices are at 113 West Fifty-seventh street. The studios and reception room will occupy the entire seventeenth floor of Steinway Hall. The aerial and transmitting equipment is located at Richmond Hill. It is stated that the officers of the Atlantic Broadcasting Corp. are Alfred H. Grebe, president; Douglas Rigney, treasurer, and Fay Leone Faurote, vice-president and general manager.

In an announcement issued by the Atlantic Broadcasting Corp. an ambitious plan of quality broadcasting is being put into effect and the opening program on December 17 will include such well-known artists as Paul Althouse, tenor, and Arthur Middleton, baritone.

The Brilliantone Steel Needle Co., New York City, has issued an attractive record display easel featuring the Gilt Edge needle. The former display easel advertising the Brilliantone needle was a distinct success.

Sam Fingrutd Returns From a Trip to Cuba

PHILADELPHIA, Pa., December 8.—Sam Fingrutd, treasurer of Everybody's Talking Machine Co., of this city, returned recently from a pleasure trip to Cuba. Mr. Fingrutd is an indefatigable worker and vacations are an exception rather than the rule with him. As Everybody's Talking Machine Co. is completing an exceptionally good year not only in the sales of Honest Quaker main springs and talking machine repair materials, but in the Okeh distributing department as well, this vacation near its close was well earned. Mr. Fingrutd reports that he enjoyed every minute of his stay on the Island and was well pleased with conditions at headquarters when he returned.

Plans New 1927 Line

The Mutual Phono Parts Mfg. Corp., New York City, will present to the trade a new line for 1927. It is expected that the new line will be ready by the first of the year and will include a further improved model of the new type of Saxophonic reproducer and tone arm as well. A. Frangipane, secretary of the company, recently returned from a trip through the Middle West where he showed samples of the new Mutual Phono Parts line.



Minerva Studio Console complete as illustrated, with built-in horn and battery compartment, less accessories, \$130.00 list.

DEMAND TELLS THE Whole Story!

We have recently been forced to practically double our manufacturing facilities in order to take care of the increased demand for Minerva receivers. This is not said boastfully, but is a simple statement of fact to prove that dealers do appreciate

**MAXIMUM VALUE
MINIMUM SERVICE WORRIES**

This is what the Minerva receiver offers. Minerva is up-to-date. Beautiful cabinets, beautiful tone, 6 tubes, plenty of volume, and one-dial convenience, which offers real selectivity. We are open for distributors in a few localities and we invite dealers everywhere, who are interested in larger profits and less work servicing sets, to write us at once.

MINERVA RADIO CO.

154 East Erie St., at Michigan Blvd.

CHICAGO, ILL.

Acclaimed Leadership!

Just Plug In



ARGUS ELECTRIC RADIO

PATENTED MAY 15TH 1923 - OTHER PATENTS PENDING

Attained this position thru sheer merit † For an electric receiver to be as good as the Argus must possess these outstanding features:

No Batteries No A or B Eliminators
No Trickle No Rectifying
Chargers Tubes

No Attachment of Any Kind

Operates on A.C. from 95 volts up

Operating cost only 1/10 of a cent per hour

Unexcelled Sensitivity
Local Stations without Aerial

Distant Stations with Loop or Indoor Aerial
Instant Approval of the Artistic Eye

Chromatic Tone Perfection—so Perfect, it is Acclaimed by the Trained Musical Ear

[Ask your jobber to demonstrate this remarkable Electric receiver]

ARGUS RADIO CORP.
257 WEST 17th ST., NEW YORK

PATENTS

THE U. S. patent Office granted to Argus Radio Corp. on October 9, 1926, a patent comprising 23 claims broadly covering the use of electrolytic rectifier in conjunction with a radio receiver, as a common source of current for filament and plate supply. Also various means of deriving the proper voltages required in various points on this system.

Consumer Satisfaction

Satisfactory Profits

Minimum Servicing

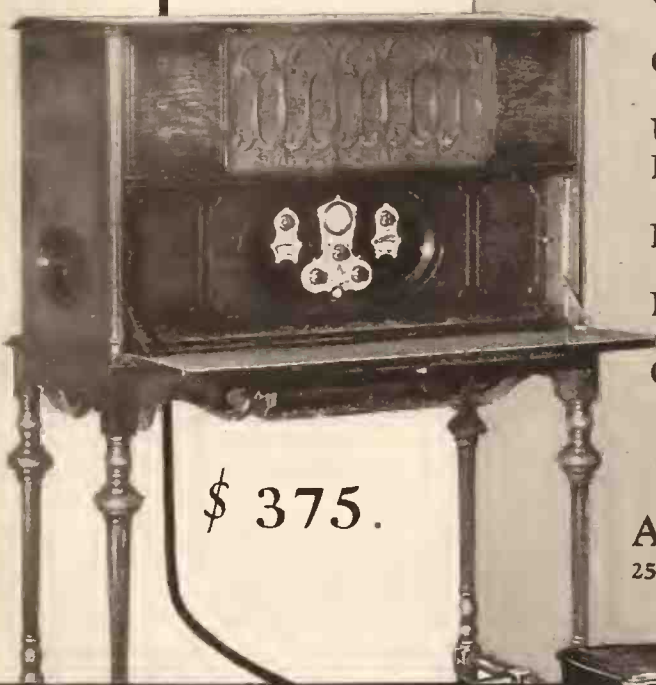

\$ 375.



\$ 277.50

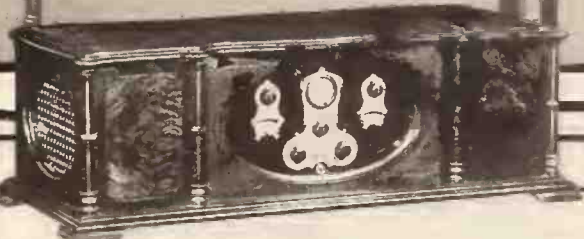

\$ 250.

ARGUS TRIED AND TRUE SINCE 1923

Baltimore Office: HERMAN A. SMITH, Greenspring Ave. & South Road Mount Washington

Chicago Office: HAWTHORNE & STEMM, 28 East Jackson Boulevard

Pittsburgh Office: W. A. BITTNER 422 First Ave.

St. Louis Office: N. DAVID THOMPSON 308 Central National Bank Bldg.

LATEST PATENTS RELATING TO TALKING MACHINES AND RECORDS

WASHINGTON, D. C., December 8.—Talking Machine and the Like. Frank Aller Mitchell, London, Eng., assignor to the Columbia Phonograph Co., Inc., Bridgeport, Conn. Patent No. 1,584,184.

This invention relates particularly to that type of talking machine which can be partly collapsed to a smaller bulk in order to render the same easily portable or to adapt it to form part of shallow furniture or for like purposes.

In connection with such talking machines as hitherto constructed, it has been proposed to mount a horn or sound reflector with the sound outlet on or above the level of the board which carries the motor, the whole being adapted to

go into a relatively small compass when the lid is closed; and it has further been proposed to lower the motor board complete with the motor, tone arm and horn into the main casing when not in use, or the tone arm has been constructed so as to be removable or to fall down into the main case of the instrument.

In these latter arrangements, also, it has been the practice to construct the amplifying horn so

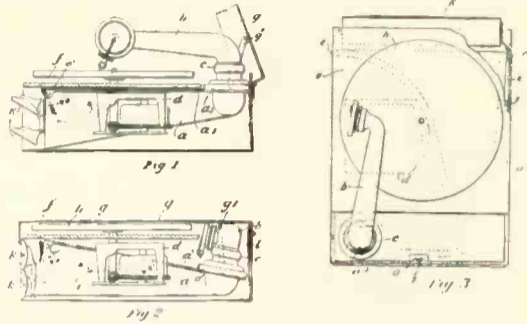

easily applied and adjusted to limit the swinging of the above-named tone-arm-and-horn-unit, toward the center of the record table, to a position at which the stylus is directly over the outer end of the sound groove, whereupon lowering of said unit will position the stylus in the groove.

United States Patents 1,184,333 of May 23, 1916, and 1,211,573 of January 9, 1917, show the general type of Edison phonograph with which this invention is usable.

Figure 1 is a perspective view of an Edison phonograph equipped with the invention, the cover being swung upwardly and the front panel being removed. Fig. 2 is a detail horizontal sectional view showing the invention in top plan. Fig. 3 is an enlarged vertical sectional view on line 3—3 of Fig. 2. Fig. 4 is an enlarged detail horizontal section on line 4—4 of Fig. 3.

Sound Amplifier. Charles G. Hensley, Brooklyn, N. Y. Patent No. 1,587,833.

This invention relates to improvements in devices for amplifying sound waves. It is here applied to the phonograph, in which adaptation it has special advantages, but it is the desire of the patentee to protect the broad features of the invention whether used in a phonograph or any other device in which it is desired to amplify sound waves, or when used as a simple megaphone.

The ideal amplifier is one into which sound waves may be introduced and wherein they will be amplified to the highest degree and be propagated as sound waves of the exact character as

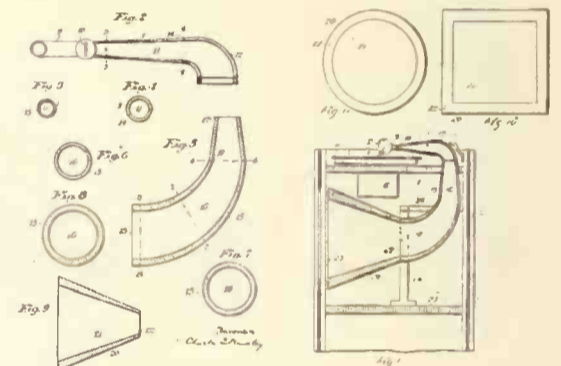

those which are introduced therein. Megaphones, as heretofore made, have had the effect of not only amplifying sound waves but of modifying them, so that the sounds propagated from the amplifier have been different in character from the sounds introduced therein. Such amplifiers seem to change the pitch of the tones and they seem to affect different tones differently, so that some tones seem to be made more hollow or "tubby" than others. It has been said that every megaphone has an inherent tone of its own and that this must be true of every megaphone. The object of the invention is to overcome each and every defect of the amplifier.

Figure 1 is a sectional view through a cabinet phonograph embodying the invention, in which view, the cabinet cover and various parts are omitted. Fig. 2 is a longitudinal sectional view of the tone arm, showing the same full size. Fig. 3 is a sectional view taken on the line 3—3 of Fig. 2. Fig. 4, is a sectional view taken on the line 4—4 of Fig. 2. Fig. 5 is a longitudinal sectional view of the throat, showing the same approximately two thirds actual size. Fig. 6, 7 and 8 are sectional views, taken, respectively, on the lines 6—6, 7—7 and 8—8 of Fig. 5. Fig. 9 is a sectional view of the horn showing the same about two-thirds actual size. Fig. 10 is an end view showing the smaller end of the horn, and Fig. 11 is a similar view of a horn of frusto-conical shape instead of frusto-pyramidal shape.

that it forms part of the lid or the main case or the horn is fixed to a board which carries the motor, such dispositions of horn greatly detracting from the full efficiency thereof, owing to the motor being in direct connection therewith.

The object of the present invention is to provide an improved construction of talking machine or the like having all the advantages of existing types without their attendant disadvantages, and the invention consists in a talking machine of the type referred to having a horn forming in itself a complete unit free from the motor board and which is mounted beneath the motor board, the horn being conveniently pivoted or hinged to the case of the instrument so that the horn and tone arm can be lowered out of the way relative to the said board when not in use without changing the shape of the horn.

The invention also consists in a talking machine of the above character in which the lowering and raising of the horn is carried out automatically by the lowering or raising of the lid or cover of the talking machine.

The invention also consists in a talking machine of the above character in which the horn is curved to pass around the outside of the motor.

Figure 1 is a part sectional side elevation with the parts in playing position. Fig. 2 is a similar with the parts collapsed. Fig. 3 is a plan of Fig. 1, with the lid removed.

Starting Attachment for Edison Phonographs. Robert Thompson, Iliou, N. Y. Patent No. 1,587,875.

This invention relates to a new and useful device for properly positioning the stylus or diamond point of an Edison phonograph, over

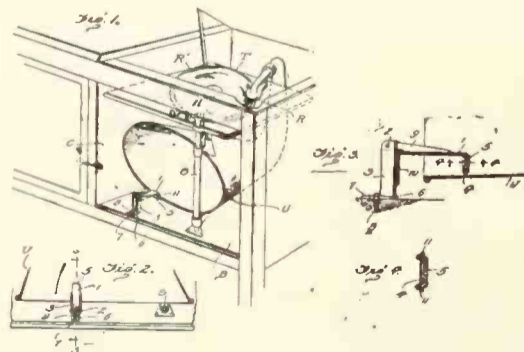

the outer end of the sound groove, so that lowering of the tone-arm-and-horn-unit will properly engage the stylus with the beginning of the record.

It is one object of the invention to provide for obtaining the desired result in an exceptionally simple and inexpensive manner, and another aim is to provide an attachment for an ordinary Edison phonograph, which may be

TELEPHONE Radio Speaker

Built like a violin—
the world's finest
musical instrument

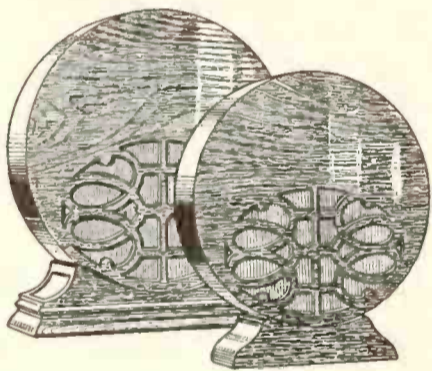

Telephone
Radiospeaker 60
An exquisite LARGE radio-
speaker, in American wal-
nut or African mahogany
\$32.50

Telephone
Radiospeaker 62
Precisely like radiospeaker
60 . . . but slightly smaller
\$22.50

Telephone Corporation
of America

449-453 West 42nd Street

New York City



GLEANINGS *from the* WORLD *of* MUSIC

Music Publishing Firms Report Output That Is Valued at \$15,089,636 in 1925

Of This Amount, Says the Federal Manufacturers' Census, \$13,835,375 Was the Value of Sheet Music—Value of Sheet Music and Books Shows an Increase of 2.5 Per Cent

WASHINGTON, D. C., December 6.—The Department of Commerce announces that, according to data collected at the biennial census of manufacturers, 1925, the establishments engaged primarily in the printing and publishing, or publishing only, of music in the United

were therefore transferred to the appropriate industries, and five reported products valued at less than \$5,000. (No data are tabulated at the biennial censuses for establishments with products under \$5,000 in value.)

The statistics for 1925 and 1923 are sum-

	1925	1923	Per cent of increase or decrease (—)
Number of establishments.....	109	110	-0.9
Wage earners (average number)*.....	955	919	3.0
Maximum month.....	Dec. 985	Nov. 951	..
Minimum month.....	June 924	June 900	..
Per cent of maximum.....	93.9	94.6	..
Wages.....	\$1,461,661	\$1,366,756	6.9
Paid for contract work (job printing).....	\$2,763,429	\$3,050,499	-9.4
Cost of materials (including fuel and electric power).....	\$1,828,230	\$2,252,830	-18.8
Products, total value.....	\$15,089,636	\$14,626,810	3.2
Sheet music and books of music.....	\$13,835,375	\$13,494,406	2.5
Other products.....	\$1,254,261	\$1,132,404	10.8
Horsepower.....	1,363	1,231	10.7

* Not including salaried employees.

States reported a total output valued at \$15,089,636, of which amount \$13,835,375 was contributed by sheet music and books of music and \$1,254,261 by receipts from miscellaneous sources, such as book and job printing, lithographing, printing of periodicals, etc. Of the total, \$4,781,395 was reported by music publishers who did their own printing and \$10,308,241 by publishers whose printing was done by others. The value of sheet music and books of music shows an increase of 2.5 per cent as compared with \$13,494,406 for 1923, the last preceding census year.

In addition, music is printed and published to some extent by establishments engaged primarily in other branches of the printing and publishing industry, but the output of music by such establishments is relatively small.

Of the 109 establishments reporting for 1925, forty-six were located in New York, fifteen in Illinois, nine in Massachusetts, eight in Ohio, seven each in Missouri and Pennsylvania, and the remaining seventeen in eleven other States. In 1923 the industry was represented by 110 establishments, the decrease to 109 in 1925 being the net result of a loss of thirteen and a gain of twelve. Of the thirteen establishments lost to the industry, six had gone out of business prior to the beginning of 1925, two were engaged primarily in lines of industrial activity other than music printing and publishing and

marized in the statement herewith. The figures for 1925 are preliminary and subject to such correction as may be found necessary upon further examination of the returns by the Federal Census Bureau.

New Goodman Number

Chappell-Harms, Inc., 185 Madison avenue, New York City, recently accepted for publication a new song called "I Found You," the words and music of which are by Lillian Rose-dale Goodman, the composer of "Cherie, I Love You." The number is quite popular in style and, wherever introduced, has been exceptionally well received, so the publishers look forward to this number duplicating the success throughout the country of the earlier contributions.

Breau With B. B. & L.

Louis Breau, the well-known song writer, has joined the popular publishing firm of Bibo, Bloedon & Lang, 1597 Broadway, New York City, as professional manager. Mr. Breau is one of the most popular writers along Broadway and has a host of friends in every channel of music activity, all of whom wish him success in his new connection.

"Mary Lou" Proving One of Season's Popular Hits

Number Being Featured With Particular Success by the Various "Singing Orchestras"—A Recent Window Display

"Mary Lou," published by Waterson, Berlin & Snyder, is one of the most popular numbers of



Featuring "Mary Lou"

the season. The song got much of its publicity through the aid of singing orchestras as the chorus lends itself readily to gang effects. Aside from the novel style of lyric, the melody is one that has wide appeal. Thus "Mary Lou" has the combination of words and melody that brings purchasers to music counters.

The trade has been quick to realize the possibilities of this song, with the result that it is often demonstrated, given a conspicuous place on the counter and has been favored with a large number of special window displays.

Herewith is shown a full window display of "Mary Lou" which recently appeared for one week in the J. G. McCrory store, 1209 Market street, Philadelphia. During the week's showing the sales of "Mary Lou" increased considerably, proving again that window displays are valuable as sales creators.

Chicago Firm Chartered

A charter has been granted to the Interstate Music Co., 525 Judson avenue, Chicago, with a capital stock of \$20,000. The company will deal in pianos and other musical instruments and is sponsored by the following: P. H. Smythe, Paul P. Smythe, Jr., and Olive Smythe.

"BESIDE A GARDEN WALL"

A Melodious Fox Trot Song

Lyric by GUS KAHN
Music by ALBERT E. SHORT
and DEL DELBRIDGE

A BEAUTIFUL BALLAD
BY THE WRITERS OF POOR BUTTERFLY

"YOUR HEART LOOKED INTO MINE"

Lyric by JOHN GOLDEN
Music by RAYMOND HUBBELL

"CALLING ME HOME"

A Great "Mother" Ballad

Lyric by L. WOLFE GILBERT
Music by JAMES V. MONACO

"You can't go wrong with any 'FEIST' song"

©1926 LEO FEIST INC.

FIVE RECORD RECORD BREAKERS



ABOVE SONGS FEATURED BY ORCHESTRA AND VAUDEVILLE ACTS FROM COAST TO COAST
IRVING BERLIN INC., 1607 BROADWAY, NEW YORK

Walter Donaldson, a Song Writer Who Writes Successes Season After Season

The Record of One of the Most Prominent of Those Who Supply the American Public With Its Popular Music—One That Would Be Hard to Excel

It's quite possible and has been done—that is for a song writer to write a lot of numbers each season. To write a lot of successes, however, is an entirely different matter. And to write many successes season after season is still

It is particularly appropriate to review Walter Donaldson's activities as a writer and composer because his song "It Made You Happy When You Made Me Cry" was used by Jesse Crawford, the nationally known organist and

Paramount Theatre both Jesse Crawford's work and the title of the song were often mentioned.

Going back to Walter Donaldson one need not delve too far in popular music history in order to prove the contention that he has established a new record for successful songs. We will pick a few out of late seasons, songs that are still familiar, some of them still being whistled. Among these are "Yes Sir, She's My Baby," "After I Say I'm Sorry," "That's Why I Love You," "Where'd You Get Those Eyes," "That Certain Party," "I Wonder Where My



Walter Donaldson

another subject. It has, of course, been done but we know of no one who has performed better in this phase of music writing than Walter Donaldson. Donaldson, by the way, off and on, spends some time in Chicago and in recent years the Windy City has tried to claim him for its own, but in looking up the records it is found that he was "born and bred in Brooklyn" and still makes his home there. His first business activity was as a board clerk in a Wall Street office of Henry B. Clews & Co. and his first song was "A Jubilee in My Old Kentucky Home." Oddly, one of the greatest of his present-day successes is "Just A Bird's-Eye View" (Of My Old Kentucky Home).

record artist, during the week of the grand opening of the new Paramount Theatre, New York, an opening, by the way, which was reported in practically every center in the United States as creating a new type of photoplay house. Naturally a song selected as a feature for such a gala event was chosen on its merit alone. It was necessary that it be a part of a program that would establish new standards for photoplay music and in an atmosphere that would meet the critical taste and ears of the general public, the photoplay industry, the music trade and the sharp-tongued newspaper critics. It seems to have done all this because in many of the reports of the opening of the

Baby Is Tonight," "Midnight Waltz," "Let's Talk About My Sweetie," "Let It Rain, Let It Pour," "My Best Girl," "Beside a Babbling Brook," "My Buddy," "Carolina In the Morning," "Mammy," "Back Home in Tennessee," "She's A Daughter of Rosie O'Grady," "You're a Million Miles From Nowhere," "How You Gonna Keep 'Em Down on the Farm," and a title that equally applies to Walter himself. "What a Man," the name of one of his songs.

Among his latest offerings, now being currently exploited, are "Kiss Your Little Baby Goodnight," "I've Got the Girl," "It Made You Happy When You Made Me Cry," "Just A Bird's-Eye View of My Old Kentucky Home" and "Thinking of You."

A lot more could be said, but when you can refer to such records as the above they really speak for themselves. "No kiddin'."

Walter Goodwin, composer of popular songs, has organized a music-publishing corporation, chartered in New York State. The new organization will be known as Walter Goodwin, Inc., and plans to establish retail stores.

MELODY—RHYTHM—NOVELTY

SILVER SONG BIRD

This fascinating fox-trot has everything

EDW. B. MARKS MUSIC CO., 223 W. 46th St., New York

"You Can't Go Wrong With Any FEIST Song"

I'VE LOST ALL MY LOVE FOR YOU

The Dramatic Waltz Ballad

by LUIS and YOUNG
HARRY AKST and AL. PIANTADOSI

WHERE'D YOU GET THOSE EYES?

Its lively rhythm and catchy chorus made it instantly popular
by WALTER DONALDSON

IN A LITTLE SPANISH TOWN

(ON A NIGHT LIKE THIS)

An Exquisite Waltz Song by
LEWIS and YOUNG
and MABEL WAYNE



© LEO FEIST 1926

British Sam Fox Co., Ltd., Granted Charter

New Company Incorporated Under Keith Prowse Auspices—London Firm Controls Fox Catalog in Great Britain and Colonies Exclusive of Canada and Australia

Sam Fox, head of the Sam Fox Publishing Co., Cleveland, O., and New York, who has

indeed happy over the new connections with such a long-established and important distribution and dealer outlet as that of the house of Keith Prowse.

He was not only pleased with his arrangement but he was agreeably surprised with the healthy conditions existing at present in the English music trade. The outlook for future business along present lines, he said, was most promising and he looked forward to a wider expansion of Fox interests under the new con-

ditions and the auspices which have already found such favor in Great Britain and the other territory included in the arrangement.

Irving Berlin Is Bringing Out Two New Numbers

"Just a Little Longer" and "That's a Good Girl" Make Five Written This Season

Among the new songs that have been added to the catalog of Irving Berlin, Inc., are two by Irving Berlin, called "Just a Little Longer" and "That's a Good Girl." This release closely follows three other Berlin successes this season, namely, "Because I Love You," "How Many Times?" and "I'm On My Way Home." Aside from the show material Irving Berlin has written and in addition to his popular selections, the release of all of these successful songs in the same season establishes a new record for this writer.

A., Y. & B. Planning Big National Campaign

New York Publishers' Drive to Cover the Entire Country From Coast to Coast

Jack Yellen and Billy Chandler, of the firm of Ager, Yellen & Bornstein, who recently returned from Chicago and other Middle West centers, arranged a Fall campaign on the A., Y. & B. catalog that will not only be felt in mid-West territory but through the plans inaugurated will cover the Pacific Coast.

These activities together with the intensive exploitation campaign arranged by the home office in the East, give this firm a prominent position in the popular music field.



Executive office of Herbert Smith, managing director of Keith Prowse. Seated are Mr. Smith and Mr. Fox disclosed signing the new and important contract

spent the past several months in European capitals, has done some unusual business for his company over there. The most important arrangement, according to reports from London, is not only the renewal of this firm's close association with Keith Prowse & Co., Ltd., for the British Isles, but includes an elaboration of past activities whereby a new company has been incorporated under the title of the Sam Fox Publishing Co. (London), Ltd.

In an interview with the London correspondent of The Talking Machine World, Mr. Fox stated that he was very much gratified and

ditions and the auspices which have already found such favor in Great Britain and the other territory included in the arrangement.

It might be mentioned here that the Fox organization is to-day an international one. There are already branches or agencies in Australia, New Zealand, Japan, France, Belgium, Holland, Germany, Austria, Spain, South America and other countries.

Keith Prowse & Co., Ltd., has been established in London for nearly a century and a half. It is one of the leaders in all phases of musical activities covering both wholesale and

"You Can't Go Wrong"

"IT MADE YOU HAPPY WHEN YOU MADE ME CRY"

The inimitable Donaldson rings the bell again with this sensational fox-trot ballad. A characteristic Donaldson melody with a lyric that thrills you!

Words and Music by
WALTER DONALDSON

"MY GIRL HAS EYE TROUBLE"

I WANT THIS! I WANT THAT!

One of the greatest Comedy Songs ever written—Gus Kahn at his best—PLUS—Teddy Fiorito's corking Fox-Trot Melody! Laughs? and HOW!

by GUS KAHN
and TED FIORITO

"JUST A BIRDSEYE VIEW"

(Of My Old Kentucky Home)

JUST A PERFECT SONG!

A happy-go-lucky singable lyric and, Oh boy!—WHAT A TUNE! Absolutely SURE-FIRE!

by GUS KAHN and
WALTER DONALDSON

With Any FEIST Song

Production Music and the Way in Which It Increases Sales for the Merchants

Properly Linked Up With the Appearances of the Production From Which the Numbers Are Taken, It Always Brings New People to the Dealers' Sheet Music Departments

According to word from a mid-West dealer, there are values in production music in addition to the profits from immediate sales. This enterprising merchant takes the attitude that people who are brought into the store for songs from musical comedies invariably are those who would not otherwise visit the establishment except at very long periods.

Production music, therefore, lures people to the music establishment, and as such music it must be valued accordingly. After all, it is getting people into retail stores that makes for large sales totals, and any method that will produce such effects among buyers should be looked upon by the merchant as more than worth while.

Now it is true that only the outstanding numbers from musical shows have large sales, so no one would suggest that the dealer carry heavy stocks of the songs of lesser importance in productions. However, a good method is to carry a fair supply of the most successful numbers and during the show's run in any particular city to have a few each of the second-best songs, as well.

The firm of Leo Feist, Inc., has, in a measure, offset the necessity for carrying any quantity of second-best sellers by issuing for its late productions folios carrying seven songs in one cover. They are entitled "Vocal Gems," each with the name of the particular show. They retail at a very popular price and include not only the hit songs but all the first seven numbers of the production.

Granting that production music is an attraction which does somewhat more than bring profit from musical shows to the store, the next question is how best to get the most out of the visit of productions to the dealer's locality. One of the simplest forms is to display the music of the current production in the window, reminding those who have attended the show that the song gems can be had inside. It may not be generally known, but all theatres are glad to loan, to any dealer, photographs of the prominent players before and during the visit of a musical comedy. Where the names of the artists are known locally, the inclusion of a photograph or photographs will not only add value to the display but will give an intimate touch to the setting.

In addition to the above, publishers and jobbers often have special display material related to particular shows. This is generally of such a nature that it lends itself very readily to window display and, more often than not, will add importance to the window and attract customers who might not be lured to the window or to the establishment otherwise.

There is not as much gamble in production music for the dealer as some would have us think. Of course, if nothing is done to encourage interest in the songs or instrumental selections from a show, there are likely to be few attracted to the establishment. The main thing in all sales of production music, on the part of the dealer, is to remind the prospective customers of particular numbers that they have heard in one or more places elsewhere. The number one show that takes to the road does so because the producer is assured of filling theatres during the tour. This is generally after the production has had months of success in New York or Chicago. As far as the typical road shows are concerned, there is very little gamble in displaying the songs from these offerings, for no producer puts out second, third and fourth shows unless he has absolute assurance that they are money makers. If either type of show has attained sufficient success to justify a tour of the country, the trade can rest assured that it has several song attractions which have aided

considerably in making it an artistic and financial success. Such being the case, songs that have made possible four and five-dollar prices for seats in New York and two and a half and three-dollar seats on the road must be of sufficient importance to create many sales for themselves. It can be taken for granted that people who pay such prices for seats for a musical show are in a position to produce the necessary funds to buy the particular songs from such productions that they like. And, what is more, they are able to purchase other goods in the establishment if their interest is aroused.

Taking these things into consideration it might be worth while for sheet music dealers to give more attention to show music. An example has been set in this direction by many talking machine dealers throughout the country who take advantage of every appearance of a musical show to display the records of the song numbers. They have found this profitable and a very big attraction to passing customers. There is no reason in the world why the sheet music dealer should not be able to attain the same end by following out similar activities.

Piantadosi Re-enters Field

Al Piantadosi, who has been writing songs for over a decade, recently re-entered the publishing business, forming the firm of Al Piantadosi with offices at 1576 Broadway, New York City. The first numbers of the new firm are "Tired Hands" and "I May Learn to Forget Some Day" (And You May Learn to Care). Both numbers in early tryouts have shown up to good advantage.

Victor Co. Makes Special Release of Adeste Fideles

A special release of "Adeste Fideles" made by the Associated Glee Clubs with 2,500 voices recorded at their concert at the Sesqui-Centennial in Philadelphia is being released by the Victor Talking Machine Co.

Buys Out W. J. Thompson

Charles E. Edel has purchased control of the music firm of Edel & Thompson, Olean, N. Y., and W. J. Thompson will continue as an executive of the business to be known as the Edel Musical Co., located at 1206 Irving street.

Clarence Williams Music Publishing Co. will feature "Candy Lips" and "Nobody but My Baby."

FOUR ACES OF SONGLAND

MEXICALI ROSE
BY H. STONÉ AND J. B. TENNEY

LULLABY MOON
BY WM. HAMER & H. J. TANDLER

IT'S LONESOME IN
BLUEBIRD LAND
BY GEO. NORTON AND HAL CAMPBELL

OPEN THE GATES OF DAWN
BY WM. M. HAMER & ANTON LADA

W.A. QUINCKE & CO. 430 S. BROADWAY
LOS ANGELES, CAL.

A New
Inspiration

"In the
Heart
of the
Hills"

By

America's
Beloved Composer

Dorothy Lee

Writer of

"Out Of The Dusk
To You"

"One Fleeting Hour"
...etc.

Published In Three Keys
With Violin And
Cello Obligato

Also As Vocal Duets
And For Men's, Mixed
And Women's Quartets

Sam Fox Pub. Co.
CLEVELAND NEW YORK



EUROPEAN HEADQUARTERS

68 Milton St. (Fore St.) E. C. 2. Clerkenwell 1448



British Trade Enthusiastic as Demand for Improved Instruments Strengthens

New Talking Machines, Electrical Method of Recording, Etc., Are of Outstanding Importance in Developing Business and Live Merchants Are Taking Advantage of Opportunity

LONDON, ENG., December 4.—Despite the severe industrial troubles in which this country has been plunged during the last few months, there is everywhere enthusiasm in talking machine circles, and it would be difficult to discover the slightest slackening in the phenomenal demand for gramophones and records. Everywhere I go I hear of nothing but the latest big developments: the new Viva-tonal Columbia instrument, the regular improvement month by month of the new process of electrical recording, now adopted by all the leading companies. The proportion of record issues devoted to music appealing to music lovers, too, everywhere receives comment and the amount of editorial space devoted to the latest doings in the gramophone world and given in the public press of the country increases every month. Every day, in almost every daily paper, one reads of music in connection with recording. Editors have perforce—particularly since the advent of the broadcasting program—had to cater for a public inspired with the desire to become as acquainted with music as with literature.

The position of the gramophone companies' shares on the market; the wonderful activity of production in the factories; the tremendous national advertising campaigns of the leading companies coupled with the special window displays by practically every music and gramophone

dealer; the record sales figures alluded to in another part of this report, all confirm my anticipations of some months ago that this season would eclipse the figures of all previous seasons.

The New Duophone Records

The Duophone & Unbreakable Record Co. is, I hear, doing exceptionally good business with its new, unbreakable records. The first issues were released a week or two ago, and the whole output of the company for some considerable time ahead is booked right up.

1927 British Industries Fair

On November 22 it was officially announced by the Department of Overseas Trade that the whole of the space in the British Industries Fair, which is to be held from February 21 to March 4 next, had been taken. The following gramophone and record companies have taken space: A. J. Balcombe, Ltd., Boumphrey, Arundel & Co., G. A. Bryan, Ltd., The Cabinet Gramophone Co., The Crystalate Mfg. Co., The Duophone & Unbreakable Record Co., Ltd., The Garrard Engineering Co., The Golden Melody Co., Gramostyles, Ltd., L. E. Jaccard, The Johnson Talking Machine Co., The Linguaphone Co., Perophone, Ltd., The Peter Pan Gramophone Co., The Piccaninny Gramophone Co., The Portable Gramophone Co., Ltd., Barnett Samuel & Sons, Smith & Co. (Gramophones), Ltd.,

S. M. T. Gramophone Co., J. Stead & Co., Thompson, Diamond & Butcher and the Vocalion Gramophone Co., Ltd.

His Master's Voice Annual Report

In presenting the annual report of the meeting of the Gramophone Co., the chairman made some interesting statements. In regard to figures he said: "The report is for the year ended June 30 last and the trading profit amounts to £338,007, being £43,714 more than the previous year's figure of £294,293, which at the time was the highest in the company's history. The amount brought forward is £413,961, and after making the usual deduction for debenture service, directors' fees and dividends declared at the last meeting, leaves a balance of unappropriated profits of £500,611."

Out of this amount the directors recommended that there be paid, less a tax, a dividend of 20 per cent on the 750,000 fully paid ordinary shares, and on £340,000, the amount paid up on the remaining 850,000 shares. This dividend, with this year's appropriations, absorbs £251,358, leaving a net figure to be carried forward of £249,000, which compares with £162,661 and £115,668 of the two previous years. The net assets of the company for the first time are valued at over £2,000,000 this year. The total assets, irrespective of patents, trademarks and good-will, amount to £2,603,373, and the liabilities, including debenture indebtedness, to £569,110, giving a balance of net tangible assets of £2,034,262, which is nearly double the par value of the issued ordinary shares.

The large increase in trade investments is accounted for by the fact that the agencies in

(Continued on page 145)

The MICRO PEROPHONE

(British and Foreign Patents Applied for)

The new Cabinet Gramophone with many distinctive features

Besides the fullest compass possible from extreme Bass to Treble and the recognized increase in tone volume, the Micro Perophone possesses a solidity of tone equally distributed throughout its compass and a wonderful stereoscopic effect in all concerted records with a tonal analysis as clearly cut as a cameo.

The Micro Perophone is for the discriminating Dealer who requires a moderate price Gramophone for a new and valuable Clientele who desires the new Electrical records musically accurate and perfectly reproduced.

First issue, 2 Models only

Style M.P.	1	in	Satin	finish	figured	Mahogany	- -	£ 9. 9.0.
"	"	2	"	"	"	Oak	- -	9. 0.0.
"	"	3	"	"	"	Mahogany	- -	11.11.0.
"	"	4	"	"	"	Oak	- -	11. 0.0.

Perfect finish Cabinet Work. Ball-bearing Tone-arm. Double-spring Helical Gear Motor. Micro Perophone Amplifier and Soundbox

Catalogues now ready. Deliveries have commenced. Large orders already placed. Can we have your enquiries for early business?

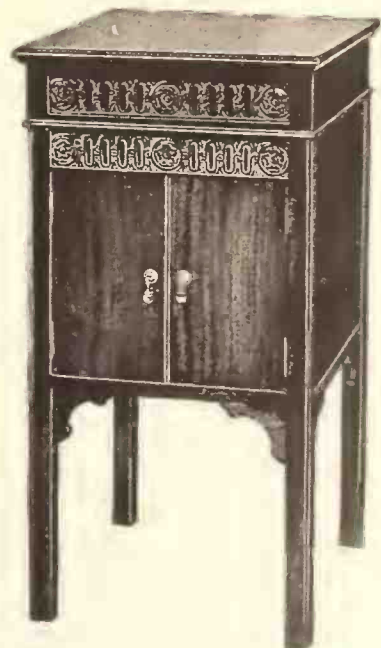

PEROPHONE, LTD.

Sole Patentees and Manufacturers

76 & 78 City Road London, E. C.

HAPPENINGS IN THE DOMINION OF CANADA

Montreal Dealers Advertising Radio Sets as Suitable Gifts for Christmas

Interest in Radio Grows With Closing of Motor Season—Many Christmas Phonograph Clubs in Operation—C. W. Lindsay, Ltd., Reports 200 Per Cent Increase—Other News

MONTREAL, CAN., December 7.—Radio supplies will constitute an important item in many retail stocks from now on. With the motoring season over, radio claims an increased interest, and as reception has been fairly good of late the fans are taking quite an interest. There are, no doubt, very good possibilities in radio as a line for Christmas trade. While the spending spirit is upon the people is a good time to interest men in radio as a Christmas gift for the family where there is no radio set in the home; or in getting something better where there may happen to be a set already in use by a family that feels interested. Quite a number of local music houses have already started to advertise radio receiving sets as suitable Christmas gifts for the whole family.

With the large number of Christmas Phonograph Clubs now being conducted by local dealers there is no excuse for any one being without a phonograph, as every inducement is given the public to buy.

Capt. Euclide Gregoire, head of the Montreal Police Department's Morality Squad, was recently presented with an Orthophonic Victrola by members of his squad and his friends, on the occasion of the completion of twenty years of service on the force.

The Compo Co., Ltd., Lachine, Que., are advertising quite freely in various dailies, weeklies, etc., throughout Canada, introducing the Apex Electro-phonics, which it advertises as a phonograph which interprets "the very soul of music."

Walter J. Scott, of Scott Sales Co., this city, will attend to the sales of Grimes radio receivers in the Province of Quebec. These sets are distributed by the Phonola Co. of Canada, Ltd., Elmira, Ont.

The Victor Talking Machine Co. of Canada, Ltd., is using Printers' Ink in the interest of portable Victrolas, drawing attention to their suitability as splendid and useful Christmas gifts.

J. W. Shaw & Co., on a recent Saturday night, on a "Seville" model Brunswick phonograph demonstrated a couple of Brunswick popular record hits and inside of an hour sold fifty Brunswick records. The machine was placed just inside the door leading to the street.

Edgar Day, Longueuil, Que., recently sold a Credenza Orthophonic Victrola to the moving picture theatre in that town, and as the instrument furnishes music for the audiences it also does good advertising for Mr. Day. He not only has special advertising slides thrown on the screen, but has an attractive "now playing" card at one side of the stage upon which it is pos-

sible to place smaller cards, giving titles of records played and informing the readers that any record can be obtained from Mr. Day.

During the recent appearance in local musical circles of the Boston Symphony Orchestra, Layton Bros., Ltd., ran newspaper copy captioned:

"Great symphony orchestras will play for you! The world's forward step in music—the new Orthophonic Victrola. The Boston Symphony, New York Symphony, Philadelphia Orchestra, Philharmonic, Creatore's or Sousa's Band,—comes to you with instrumentation complete, the music sounding just as played!"

Annual Radio Exposition Feature of the Month in Toronto Territory

Annual Radio Show Is Great Success—Canadian Phonograph Manufacturers Assn. Discuss Plans for National Exposition of 1927—Fansteel Service Station Opened

TORONTO, ONT., December 7.—With the largest crowd that ever assembled in one place in the city to hear radio demonstrations and have models of radio receivers explained, the recent Toronto Radio Show is regarded by all the directors as having been an outstanding success from every angle. The night preceding the close of the show a banquet was held, which was attended by exhibitors and their friends, with R. O. Bull, president, Canadian Radio Trades Association, presiding.

A Fansteel service station for Balkite units is being operated at 132 Richmond street, West, by E. L. Mendoza, under the direction of Burndept, of Canada.

A meeting was held recently of the Canadian Phonograph Manufacturers' Association to discuss plans and consider recommendations in connection with the Canadian National Exhibition of 1927.

Pollock-Welker, Ltd., Kitchener, Ont., have secured an order for 1,000 Helycon Motors with which to equip 1,000 phonographs that had been ordered for educational purposes by the Victorian State Educational Department, of Melbourne, Australia. This order was won in open competition against makers of English, German and Swiss products. One hundred and eighteen cases of phonograph motors and parts were recently shipped for export in one day. Business is particularly good in shipments to Australia and New Zealand.

A movement for the suppression of evils in the radio trade was started at Ottawa, when local music, radio and other dealers interested in the sale and distribution of radio equipment held a general meeting, at which the Ottawa Radio Trades Association was formally organized. It was announced that a series of lectures would

Then followed a description of the various models of Orthophonic Victrolas and the prices. Good-sized newspaper copy is now appearing under this firm's name advocating the purchase of 4-7, another member of the Orthophonic Victrola family. This concern is a consistent user of large advertising space.

C. W. Lindsay, Ltd., report a 200 per cent increase in radio sales as against the corresponding month of last year. December sales of 1925 established a record, but November of this year is the biggest in the firm's history. They feature Stewart-Warner radio receiving sets. J. B. O'Brien, manager of the phonograph and radio departments of this firm, recently demonstrated before the members of the Y. W. C. A. the Brunswick Panatrop, which aroused considerable interest.

be held, at which questions regarding the limit of service on sets, the limitation in the sale of cheap sets, and general advice regarding conditions would be held under the auspices of the new association.

Judgment has been given in favor of the Canadian General Electric Co., Ltd., Toronto, in its suit against J. Earle Young and Bruce L. Robinson, distributors, Ltd., of Calgary, Alta., for infringement of radio patents.

F. Lawrence, Winnipeg, Adds Kellogg Radio Line

Dealers in Winnipeg Territory Report Increased Interest in Radio Apparatus—Brunswick Dealer Adds to Selling Force

WINNIPEG, MAN., December 6.—Kellogg radio receivers will be sold by F. Lawrence, of this city, who is acting as traveling representative.

With the arrival of the longer evenings greater attention is again being given to radio and radio equipment. While the keenness of the craze has passed to some extent there is still a large crop of young enthusiasts that represent very heavy potential spending for radio supplies. The tendency to experiment with radio is universal and to the youth with initiative there is no end of effort being made to get something new. Dealers are reported to be stocking radio supplies in a large way in anticipation of a heavy Winter demand, and sales of batteries are brisk.

A Winnipeg store, which has made a pronounced success of its boys' department, loses no opportunity to cultivate the good will of boys, whether they are actually buying or not. With every purchase of smaller sizes some little gift is included, which in itself means little but carries influence as a remembrance in the boy's mind. The same store has a radio man who is allowed a little window to exhibit his sets, and there is a standing offer that any boy who is interested in radio can bring his hook-up or any other problems to this man and get the best of advice without being under any obligation.

Farquhar & Shaw, Brunswick specialists, Winnipeg, report excellent business this Fall, so much so that they have had to add to their selling force.

Volkwein Bros., Pittsburgh, Pa., have added the Bosch line of radio receivers.

Talking Machine Springs and Repair Parts

NONE BETTER IN QUALITY NONE LOWER IN PRICE

THE RENÉ MANUFACTURING CO.
MONTVALE, NEW JERSEY

Advance RECORD BULLETINS for January, 1927

Victor Talking Machine Co.

LIST FOR DECEMBER 3

- 20272 Because I Love You—Waltz, Nat Shilkret and Victor Orch. 10
- Just a Little Longer—Fox-trot, Philip Spitalny and His Orch. 10
- 20273 I'd Rather Be the Girl in Your Arms (Than the Girl in Your Dreams)—Fox-trot, Jean Goldkette and His Orch. 10
- Sunday—Fox-trot, Jean Goldkette and His Orch. 10
- 20285 Hello, Bluebird—Fox-trot, Art Landry and His Orch. 10
- Hugs and Kisses—Fox-trot, Art Landry and His Orch. 10
- 20298 Oh, Come, All Ye Faithful (Adeste Fideles) (Portugal)—Grand Organ... Mark Andrews 10
- Silent Night (Gruber)—Grand Organ, Mark Andrews 10
- 20286 Meadow Lark... Correll-Gosden 10
- Kiss Your Little Baby, Good-Night!, Correll-Gosden 10

LIST FOR DECEMBER 10

- 20289 The Little White House—Fox-trot, Waring's Pennsylvanians 10
- Leander—Fox-trot, George Olsen and His Music 10
- 20290 The Two of Us—Fox-trot, Johnny Hamp's Kentucky Serenaders 10
- Beside a Garden Wall—Fox-trot, Art Landry and His Orch. 10
- 20265 Barcelona... Jesse Crawford 10
- Hello, Aloha!—How Are You?... Jesse Crawford 10
- 20288 I'd Love to Call You My Sweetheart, Johnny Marvin 10
- Hum Your Troubles Away... Johnny Marvin 10
- 20291 Hello, Bluebird... Jim Miller-Charlie Farrell 10
- No Wonder She's a Blushing Bride, Jim Miller-Charlie Farrell 10
- 20299 Christmas Morning at Clancey's... Steve Porter 10
- Clancey's Wooden Wedding—Comic Song, Steve Porter 10

LIST FOR DECEMBER 17

- 20315 Lay Me Down to Sleep in Carolina—Fox-trot, Nat Shilkret and Victor Orch. 10
- It Made You Happy When You Made Me Cry—Fox-trot... Waring's Pennsylvanians 10
- 20293 Sadie Green, Vamp of New Orleans—Fox-trot, Five Harmoniacs 10
- Coney Island Washboard—Fox-trot, Five Harmoniacs 10
- 20312 There Ain't No Maybe in My Baby's Eyes, Jack Smith (The Whispering Baritone) 10
- No One But You Knows How to Love, Jack Smith (The Whispering Baritone) 10
- 20314 Don't Sing Aloha When I Go... Four Aristocrats 10
- She's Still My Baby... Four Aristocrats 10
- 20292 For My Sweetheart... Frank Banta 10
- Just a Little Longer... Frank Banta 10
- 20278 The Sweetest Story Ever Told... Neapolitan Trio 10
- Simple Confession (Simple Aveu) (Thome), Neapolitan Trio 10
- 20282 Over the Waves (Sobre las Olas) (Rosas)—Waltz... Mario Perry 10
- Sirens Waltz (Waldteufel)... Mario Perry 10
- 20283 Sweet Genevieve... Peerless Quartet 10
- Where the River Shannon Flows... Franklyn Baur 10

LIST FOR DECEMBER 24

- 20327 Do-Do-Do—Fox-trot, George Olsen and His Music 10
- Clap Yo' Hands—Fox-trot, Roger Wolfe Kahn and His Orch. 10
- 20322 How Could Red Riding Hood? Fox-trot, Jan Garber and His Orch. 10
- I'm Tellin' the Birds, Tellin' the Bees—Fox-trot, George Olsen and His Music 10
- 20263 Cherie, I Love You... Jesse Crawford 10
- Ting-a-Ling (Waltz of the Bells)... Jesse Crawford 10
- 20324 I Never Knew What the Moonlight Could Do, Correll-Gosden 10
- Give Me a Ukulele and a Ukulele Baby, Mitchell Brothers 10
- 20323 Hard to Get Gertie... Jane Green 10
- Won't Be Long Before She Belongs to Me, Jane Green 10

Columbia Phono. Co., Inc.

CELEBRITY SERIES

- 9011-M Il Barbiere di Siviglia: Largo al factotum (Make Way for the Factotum) (Rossini)—Baritone Solo... Ricardo Stracciar 12
- Rigoletto: Cortigiani, vil razza dannata (Vile Race of Courtiers) (Verdi)—Baritone Solo, Riccardo Stracciar 12

- 5064-M Lakme: Ou va la jeune Hindoue (Bell Song) (Delibes)—Soprano Solo... Eva Leoni 12
- Parysatis: Le rossignol et la rose (The Nightingale and the Rose) (Saint-Saens)—Soprano Solo... Eva Leoni 12
- 126-M Stille Nacht, Heilige Nacht (Silent Night, Holy Night) (Gruber)—Soprano Solo, Elsa Alsen 10
- O Du Frohliche—Soprano Solo... Elsa Alsen 10

DANCE MUSIC

- 770-D Tiger Rag—Fox-trot, Ted Lewis and His Band 10
- Blues (My Naughty Sweetie Gives to Me)—Fox-trot... Ted Lewis and His Band 10
- 776-D Petrushka—Fox-trot, with Vocal Chorus by Charles Kaley... Leo Reisman and His Orch. 10
- Alabama Stomp (From "Earl Carroll's Vanities")—Fox-trot, Leo Reisman and His Orch. 10
- 798-D You Will—Won't You? (From "Criss Cross")—Fox-trot, with Vocal Chorus by Johnny Marvin, Ipana Troubadours (S. C. Lanin, Dir.) 10
- In Araby With You (From "Criss Cross")—Fox-trot, with Vocal Chorus by Charles Kaley, Ipana Troubadours (S. C. Lanin, Dir.) 10
- 772-D Just a Bird's-eye View (Of My Old Kentucky Home)—Fox-trot, with Vocal Chorus by Keller Sisters and Lynch, Ipana Troubadours (S. C. Lanin, Dir.) 10
- Give Me a Ukulele—Fox-trot, with Vocal Chorus by Keller Sisters and Lynch, Ipana Troubadours (S. C. Lanin, Dir.) 10
- 793-D Sunday—Fox-trot, with Vocal Chorus by Charles Kaley... The Radiolites 10
- If I'd Only Believed in You—Fox-trot, with Vocal Chorus by Charles Kaley, The Radiolites 10
- 795-D Hello, Bluebird—Fox-trot, with Vocal Chorus by Tom Stacks, Clicquot Club Eskimos (H. Reser, Dir.) 10
- Some Day—Fox-trot, with Vocal Chorus by Jimmy Flynn, Clicquot Club Eskimos (H. Reser, Dir.) 10
- 774-D Susie's Feller—Fox-trot, with Vocal Chorus by Tom Stacks... Harry Reser's Syncopators 10
- Oh! How I Love Bulgarians—Fox-trot, with Vocal Chorus by Stacks and Reser, Harry Reser's Syncopators 10
- 773-D Just a Little Longer—Fox-trot, with Vocal Chorus by The Crooners, Fred Rich and His Hotel Astor Orch. 10
- That's a Good Girl—Fox-trot, with Vocal Chorus by The Crooners, Fred Rich and His Hotel Astor Orch. 10
- 777-D All Alone Monday (From "The Ramblers")—Fox-trot, with Vocal Chorus by Frank Harris... Fred Rich and His Hotel Astor Orch. 10
- When Day Is Done—Fox-trot, with Vocal Chorus by Frank Harris, Fred Rich and His Hotel Astor Orch. 10

- 800-D Here Comes Fatima—Fox-trot, with Vocal Chorus by Frank Harris, California Ramblers 10
- My Baby Knows How—Fox-trot, with Vocal Chorus by Frank Harris, California Ramblers 10
- 769-D Hoodie Dee Doo Dee Doodoo—Fox-trot, with Vocal Chorus... Art Kahn and His Orch. 10
- I Ain't Got Nobody—Fox-trot, with Vocal Chorus... Art Kahn and His Orch. 10
- 794-D Meadow Lark—Fox-trot, with Vocal Chorus, Cole McElroy's Spanish Ballroom Band 10
- Whose Arms Are You in To-night?—Fox-trot, with Vocal Chorus, Cole McElroy's Spanish Ballroom Band 10
- 778-D Blame It on the Waltz—Waltz, with Vocal Chorus by Charles Hart, The Cavaliers (Waltz Artists) 10
- Cheritza (Pretty Little Viennese)—Waltz, The Cavaliers (Waltz Artists) 10

INSTRUMENTAL MUSIC

- 50028-D Espana Waltz (Waldteufel), Jacques Jacobs' Ensemble 12
- L'Estudiantina (Waldteufel)—Waltz, Jacques Jacobs' Ensemble 12
- 797-D Farewell Blues... Sol Hoppin's Novelty Trio 10
- Stack o' Lee Blues... Sol Hoppin's Novelty Trio 10
- 781-D Adeste Fideles (Oh, Come, All Ye Faithful) Chimes Solo... Howard Kopp 10
- Silent Night, Holy Night—Chimes and Organ with Brass Quartet... Howard Kopp 10
- 783-D Dance of the Toy Regiment—Xylophone Solo, George Hamilton Green 10
- Dancing Stars—Xylophone Solo, George Hamilton Green 10
- 801-D Baby Face—Vocal... Charles Kaley 10
- My Baby Knows How—Vocal... Charles Kaley 10

- 768-D School Day Sweethearts—Vocal Duet, Ford-Glenn 10
- Won't You Come Over to My House—Vocal Duet... Ford-Glenn 10
- 775-D I Never Knew What the Moonlight Could Do... Kitty O'Connor (The Girl Baritone) 10
- I Don't Mind Being All Alone, Kitty O'Connor (The Girl Baritone) 10
- 771-D Just Waiting for You, Art Gillham (The Whispering Pianist) 10
- Crying Again, Art Gillham (The Whispering Pianist) 10
- 796-D Elsie Shultz-En-Heim—Vocal... Frank Harris 10
- Yiddisha Charleston—Vocal... Frank Harris 10
- 791-D For My Sweetheart—Vocal Harmony, Ethel and Dorothea Ponce 10
- To-night You Belong to Me—Vocal Harmony, Ethel and Dorothea Ponce 10
- 779-D That's a Good Girl—Comedienne, Vaughn De Leath 10
- Susie's Feller—Comedienne, Vaughn De Leath 10
- 799-D Give Me a Ukulele, Vaughn De Leath-Gerald Macy 10
- Love Me All the Time, Vaughn De Leath-Gerald Macy 10
- 780-D Mother Dear—Vocal... Allan Jordan 10
- Don't Forget the Pal You Left at Home—Vocal... Allan Jordan 10
- 782-D The Holy City... Columbia Mixed Quartet 10
- Silent Night, Holy Night, Columbia Mixed Quartet 10

Edison Disc Records

ALREADY RELEASED SPECIALS

- 51849 Just a Bird's-eye View (Of My Old Kentucky Home) (Kahn-Donaldson) Male Voices, National Male Quartet
- Hum! Hum! Hum! Hum! Your Troubles Away (Friend-Woods) Male Voices, National Male Quartet
- 51846 On the Waves of the Volga—Waltz (N. R. Bakalainikov)... Aladar Sio's Orch. 10
- Somewhere the Gypsies Are Playing—Waltz (Szlatinay Sandor)... Aladar Sio's Orch. 10
- 51844 Elsie Schultz-En-Heim (Friend-Silver)... Billy Jones 10
- For no Good Reason at All (Lewis, Young and Baer)... Billy Jones 10
- 80873 Goin' Home (Words by William Arms Fisher adapted to the Largo from "The New World Symphony" by Dvorak)... Walter Scanlan 10
- Kashmiri Song (Pale Hands I Loved) (Hope-Amy Woodfore-Finden)... Walter Scanlan 10
- 51856 The Miami Storm (Carson J. Robison) Singing, Violin and Guitar... Vernon Dalhart 10
- Billy Richardson's Last Ride (Meeks-Robison) Singing, Violin and Guitar... Vernon Dalhart 10
- 51850 Hokum-Smokum (Yodelin' Indian Man) (Al Bernard and Sammy Stept), Al Bernard-Frank M. Kamplain 10
- In Tyrol—Yodel Song (Al. H. Wilson-Sidney R. Ellis)... Frank M. Kamplain 10
- 51853 Marine Flashes March (Joe Thome) Zither and Guitar... The Alpine Mountaineers (Pols-Franchini) 10
- Steyrer Laendler (H. Hauptmann) Zither and Guitar... The Alpine Mountaineers (Pols-Franchini) 10
- 51859 Camille (Sidney D. Mitchell-Al Sherman), Marguerite Ringo-Walter Scanlan 10
- No One Knows (But the Red, Red Rose) (Sidney D. Mitchell-Westell Gordon), Ernest Davis 10

(Continued on page 142)

YOU CAN'T GO WRONG WITH ANY 'FEIST' SONG!

FIRE
An "Alarming" Novelty Song
by Byron Gay and Richard Whiting
Writers of "HORSES"

Brisk!
Lively!
Cheerful!

"I'VE GOT THE GIRL"

WALTER DONALDSON'S
New Fox Trot Song

SUNDAY
A Fox Trot Song That's A Hit Any DAY!
by NED MILLER, CHESTER COHN, JULES STEIN and BENNIE KRUEGER

ADVANCE RECORD BULLETINS FOR JANUARY—(Continued from page 141)

- 51858 Don't Sing Aloha When I Go (Walter Smith-Ben Black-Neil Moret) The Four Aristocrats
- A Little Music in the Moonlight (Bernie Grossman-Jack Stanley) The Four Aristocrats
- 51861 We Will Meet at the End of the Trail (Jean Acker) (Mrs. Rudolph Valentino). Walter Scanlan I'd Love to Meet That Old Sweetheart of Mine (Benny Davis-Joe Burke), James Doherty and Chorus
- 51864 Watermelon Hanging on the Vine (Singing with Harmonica and Guitar) Ernest V. Stoneman—The Blue Ridge Mountaineer and Guitar) Ernest V. Stoneman—The Blue Ridge Mountaineer
- 51869 Christmas Recollections The Yuletide Ensemble Star of the East (George Cooper-A. Kennedy), Calvary Choir
- 51865 I Want to Be Known as Susie's "Feller" (Lew Brown-Dave Dreyer), Frank Braidwood—The Cowboy Baritone Calling Me Home (L. Wolfe Gilbert-James V. Monaco), Frank Braidwood—The Cowboy Baritone
- 51870 I've Lost All My Love for You (Lew Young-Akst-Piantadosi)—Piano Solo Constance Mering Beside a Garden Wall (Kahn-Short-Delbridge)—Piano Solo Constance Mering
- 51867 If You Think Your Luck Is Hard (Mister Black Boy Good Night) (Al Bernard) Al Bernard
- I'm on My Way Home (Irving Berlin). Johnny Ryan
- 51871 Rock All Our Babies to Sleep—Singing, Yodeling, Violin, Harmonica and Guitar. Bud Thompson
- A Boy's Best Friend Is His Mother (Harry Miller-J. P. Skelly)—Singing, Violin and Guitar Bud Thompson
- 51874 Hello Bluebird (Friend), Vaughn de Leath—The Radio Girl
- How I Love You I'm Tellin' the Birds—Tellin' the Bees (Brown-Friend), Vaughn de Leath—The Radio Girl
- 80875 Largo (Veracini-Corti)—Violin Solo, Arcadie Birkenholz
- Scenes de la Csarda (Jeno Hubay, Op. 18)—Violin Solo Arcadie Birkenholz

GENERAL GROUP

- 60059 Por Tus Ojos (For Your Eyes) (A. Manuel Ponce-Eduardo Sanchez de Fuentes) in Spanish Consuelo Escobar de Castro
- Rosalinda (Eduardo Sanchez de Fuentes) in Spanish Consuelo Escobar de Castro

FLASHES

- 51851 Lay Me Down to Sleep in Carolina—Fox-trot, (Yellen-Ager) Golden Gate Orch.
- Cover Me Up With Sunshine (And Feather My Nest With Love)—Fox-trot (Dixon-Henderson) Jack Albin's Orch.
- 51852 Brown Sugar—Fox-trot (Barris), Joe Candullo and His Everglades Orch.
- I Found a Million-Dollar Baby in the Five and Ten Cent Store)—Fox-trot (Rose-Fisher), Jack Albin's Orch.
- 51854 Alabama Stomp—Fox-trot (From Earl Carroll's "Vanities" Fifth Edition) (Creamer-Johnson), Red-Miff's Stompers
- Stampede—Fox-trot (Fletcher Henderson), Red-Miff's Stompers
- 51857 I Never Knew What the Moonlight Could Do—Fox-trot (Coslow-Spier), Oreste and His Queensland Orch.
- Vocal Refrain by Harry Hart
- Ev'rything's Peaches (For Peaches and Me)—Fox-trot (Squires), Oreste and His Queensland Orch.
- 51855 I'd Love to Call You My Sweetheart—Fox-trot (Goodwin-Shay-Ash), Don Voorhees and His Earl Carroll's "Vanities" Orch.—Vocal Refrain by Harold Lambert
- Just One More Kiss—Fox-trot (Owens-Montgomery), Don Voorhees and His Earl Carroll's "Vanities" Orch.—Vocal Refrain by Harold Lambert
- 51860 Pretty Cinderella—Fox-trot (Will J. Harris), Golden Gate Orch.
- Sweet Thing—Fox-trot (Williams-Kahn-Verges), Golden Gate Orch.—Vocal Refrain by Arthur Hall
- 51862 The Little White House (At the End of Honey-moon Lane)—Fox-trot (From "Honeymoon Lane") (Dowling-Hanley), Duke Yellman and His Orch.
- Vocal Refrain by Arthur Fields
- All Alone Monday—Fox-trot (From "The Ramblers") (Kalmar-Ruby) Golden Gate Orch.
- Vocal Refrain by Arthur Fields
- 51863 Meadow-Lark—Fox-trot (Keidel-Fiorito), Duke Yellman and His Orch.
- My Pal Jerry—Fox-trot (Fred Rose), Duke Yellman and His Orch.
- Vocal Refrain by Hall-Ryan
- 51872 Stars (Are the Windows of Heaven)—Fox-trot (Malie-Steiger) B. A. Rolfe
- (Trumpet Virtuoso) and His Palais d'Or Orch.
- Lonely Acres (In the West)—Fox-trot (Robison) Green Bros. Novelty Band
- 51866 Happy Go Lucky—Medley Fox-trot—Intro.: "When I Make a Million for You" and "Love Thoughts" (Evans-Gwynne-Lucien Denni), Duke Yellman and His Orch.
- Vocal Refrains by Arthur Fields
- Chinese Moon—Oriental Fox-trot (Bronfin-Nussbaum) B. A. Rolfe (Trumpet Virtuoso) and His Palais d'Or Orch.
- 51873 Son of the Sheik—Fox-trot (Powell-Mosay), Clyde Doerr and His Orch.
- Just a Little Longer—Fox-trot (Irving Berlin), Clyde Doerr and His Orch.
- 51877 Fire! (An "Alarming" Novelty) Fox-trot (Gay-Whiting) Earl Oliver's Jazz Babies
- Vocal Refrain by Tom Howard
- Cows—Fox-trot (Ponce-Leslie-Stone), Earl Oliver's Jazz Babies
- Vocal Refrain by Tom Howard

Edison Blue Amberol Records

- 5228 Measly Blues, Joe Candullo and His Everglades Orch.
- 5229 Crazy Quilt—Piano Solo Constance Mering
- 5230 My Cutey's Due at Two-to-Two—Descriptive Tenor Duet Al. Campbell-Jack Kaufman
- 5231 Moonlight on the Ganges—Fox-trot Oriental, Duke Yellman and His Orch.
- 5233 Why Do Ya Roll Those Eyes—Fox-trot (From "Americana") B. A. Rolfe (Trumpet Virtuoso) and His Palais d'Or Orch.
- 5235 I Never Knew What the Moonlight Could Do Frank Braidwood—The Cowboy Baritone
- 5236 I'm Going to Park Myself in Your Arms—Fox-trot Duke Yellman and His Orch.
- 5237 The Miami Storm (Singing, Violin and Guitar), Vernon Dalhart
- 5238 In a Garden of Hawaii—Waltz, Aloha Hawaiian Orch.

- 5239 There's a New Star in Heaven To-Night (Rudolph Valentino)—Singing, Violin and Guitar, Vernon Dalhart
- 5241 The Old Hickory Cane—Singing, Harmonica and Guitar Ernest V. Stoneman
- The Blue Ridge Mountaineer
- 5242 Dwellers in the Western World—No. 2—The White Man Sousa's Band
- 5243 Weddin' of Sandy Macnab Harry Lauder
- 5244 Babes in Toyland Selections, Victor Herbert and His Orch.
- 5245 O Gladsome Light and Lord's Prayer, Fifth Avenue Presbyterian Choir
- DECEMBER, 1926, BLUE AMBEROL SUPPLEMENT
- 5232 Billy Richardson's Last Ride—Singing, Violin and Guitar Vernon Dalhart
- 5234 Nola—Banjo Solo Ernie Anderson
- 5240 An Old-Fashioned Picture—Singing, Violin and Guitar Vernon Dalhart
- 5246 Cluck Old Hen—Country Dance of the Southern Mountaineers with Singing, Fiddlin' Powers and Family
- 5247 Bass Ale Blues, Joe Candullo and His Everglades Orch.
- 5249 Rye Waltz Henry Ford's Old-Time Dance Orch.
- 5250 I Found a Million-Dollar Baby (In a Five and Ten Cent Store)—Fox-trot Jack Albin's Orch.
- 5251 Because I Love You Charles Harrison
- 5252 A Little Music in the Moonlight—Singing and Instrumental The Four Aristocrats
- 5253 I'd Love to Call You My Sweetheart—Fox-trot, Don Voorhees and His Earl Carroll's "Vanities" Orch.—Vocal Refrain by Harold Lambert
- 5254 Meadow-Lark—Fox-trot, Duke Yellman and His Orch.
- 5255 Star of the East—Mixed Voices Calvary Choir
- 5256 Dwellers in the Western World—No. 3—The Black Man Sousa's Band
- 5257 Slavic March Victor Herbert and His Orch.
- 5258 McGregor's Toast Harry Lauder

Okeh Records

DECEMBER 1 RELEASE POPULAR DANCE RECORDS

- 40709 Looking at the World Through Rose-Colored Glasses (Malie-Steiger)—Fox-trot, with Chorus by Billy Jones Sam Lanin's Melody Sheiks
- I Want to Be Known as Susie's Feller (Brown-Dreyer)—Fox-trot, with Chorus by Tom Stacks Harry Reser's Jazz Pilots
- 40710 On the Riviera (Gilbert-Van Loan-Rich)—Fox-trot Hotel Astor Orch.
- Hugs and Kisses (Klages-Alter)—Fox-trot, Hotel Astor Orch.
- 40712 Cross Your Heart (From "Queen High") (Gensler)—Fox-trot. Harry Raderman's Red Hotters That Night in Araby (Snyder)—Fox-trot, Harry Raderman's Red Hotters
- 40714 I Love the Moonlight (Davis-Akst-Richman)—Fox-trot, with Vocal Chorus by Billy Jones, Mike Markels' Orch.
- Hello, Bluebird (Friend)—Fox-trot, with Chorus by Billy Jones Mike Markels' Orch.

POPULAR VOCAL RECORDS

- 40711 Just a Melody (Robison)—Tenor Novelty Duet, with Guitar, 'Cello, Violin and Whistling Accomp. Vernon Dalhart-Carson Robison
- When You're Far Away (Robison)—Tenor Novelty Duet, with Guitar, 'Cello, Violin and Whistling Accomp., Vernon Dalhart-Carson Robison
- 40713 Everybody's Got a Girl (But Me) (Burns)—Baritone, with Piano by Dave Kaplan and Guitar by John Cali Ernest Hare
- By the Side of the Omelette Sea (Langworthy)—Tenor, with Piano by Dave Kaplan and Guitar by John Cali Billy Jones

OLD-TIME TUNE RECORDS

- 45065 Katie Kline—Singing, with Guitar and Harmonica Ernest V. Stoneman
- Are You Angry With Me, Darling?—Singing, with Guitar, Harmonica and Fiddle, Ernest V. Stoneman-Fiddler Joe
- 45066 Home Brew (Walburn-Hethcox)—Fiddle and Guitar Duet. George Walburn-E Emmett Hethcox
- Macon Georgia Bound (Walburn-Hethcox)—Fiddle and Guitar Duet, George Walburn-E Emmett Hethcox

STANDARD AND SACRED RECORDS

- 45067 The Haven of Rest (Gilmour-Moore)—Organ Accomp. The Jenkins Family
- The Railroad of Life (Jenkins)—Organ Accomp., The Jenkins Family

RACE RECORDS

- 8403 Four and Twenty Elders—Spiritual; Sermon with Singing Rev. J. M. Gates
- I Prayed, I Prayed—Spiritual; Sermon with Singing Rev. J. M. Gates
- 8408 In My Southern Harem (Brooks)—Baritone and Piano Shelton Brooks
- I Was Marching Through Georgia (Brooks)—Baritone and Piano Shelton Brooks
- 8409 Don't Forget to Mess Around (Barbarin)—Contralto, with Accomp. by Perry Bradford's Mean Four Alberta Hunter
- I'm Tired Blues (Henry)—Contralto, with Accomp. by Piano and Trumpet. Alberta Hunter
- 8410 It's Evil Hearted Me (Spivey)—Contralto and Piano Victoria Spivey
- Santa Fe Blues (Spivey)—Contralto and Piano, Victoria Spivey
- 8411 I Have No Sweet Woman Now (Johnson)—Baritone, with Piano and Guitar Accomp. by James Johnson Lonnie Johnson
- Lonnie's Got the Blues (Johnson)—Baritone, with Piano and Guitar Accomp. by James Johnson Lonnie Johnson
- 8412 Shipwrecked Blues (Williams)—Contralto, with Piano by Clarence Williams Sara Martin
- Numbers on the Brain (Larry-Jackson)—Contralto, with Piano by Clarence Williams Sara Martin

DECEMBER 15 RELEASE POPULAR DANCE RECORDS

- 40716 I Don't Mind Being All Alone When I'm All Alone With You (Gaskill-McHugh-Mills)—Fox-trot, with Chorus by Lem Cleg, Sam Lanin's Melody Sheiks
- My Baby Knows How (Davis-Akst-Richman)—Fox-trot, with Chorus by Lem Cleg, Sam Lanin's Melody Sheiks
- 40718 Just a Little Longer (Berlin)—Fox-trot, with Chorus by The Crooners Hotel Astor Orch.
- I Still Believe in You (Gilbert-Rich)—Fox-trot, with Chorus by The Crooners, Hotel Astor Orch.
- 40719 I'm Tellin' the Birds—Tellin' the Bees How I Love You (Brown-Friend)—Fox-trot, with Chorus by Tom Stacks, Harry Reser's Jazz Pilots
- How Could Red Riding Hood? (Rando'ph-Whichard)—Fox-trot, with Chorus by Tom

- Stacks Harry Reser's Jazz Pilots
- 40720 When You Waltz With the One You Love (Flynn-Sherman)—Waltz, with Chorus by Henry Moeller Justin Ring's Yellow Jackets
- Love Me All the Time (Rose-Dennis-Magine)—Waltz, with Chorus by Henry Moeller, Justin Ring's Yellow Jackets

POPULAR VOCAL RECORDS

- 40715 Candy Lips (I'm Stuck on You) (Lauria-Jackson)—Contralto, with Accomp. by Clarence Williams' Blue Seven Eva Taylor
- Scatter Your Smiles (Kortlander-Wendling)—Contralto, with Accomp. by Clarence Williams' Blue Seven Eva Taylor
- 40717 Just Whistle (Robison)—Singing, Whistling and Guitar Carson Robison
- Nola (Arndt)—Piano and Whistling, Carson Robison
- 40721 If My Baby Cooks (As Good as She Looks) (Kahal-Carroll)—Vocal Duet, with Piano Accomp. by Dave Kaplan. Billy Jones-Ernest Hare
- Short an' Sweet (Dougherty-Tracey-Ehrlich)—Vocal Duet, with Piano Accomp. by Dave Kaplan Billy Jones-Ernest Hare

OLD-TIME TUNE RECORDS

- 45068 Fire in the Mountain—Singing and Playing, Fiddlin' John Carson and His Virginia Reelers
- Peter Went Fishing—Singing and Playing, Fiddlin' John Carson and His Virginia Reelers
- 45069 Gypsy's Warning—Singing and Fiddle, with Guitar Accomp. "Gooby" Jenkins
- Fiddlin' Bill (Jenkins)—Singing, with Fiddle and Guitar Accomp. "Gooby" Jenkins
- 45070 Just Over the River (Spugin-Fillmore)—Guitar and Violin Accomp., Carson Family Sacred Quartet
- I Need Thee All the Time (Rowe-Ducan)—Guitar and Violin Accomp., Carson Family Sacred Quartet

RACE RECORDS

- 8414 Candy Lips (I'm Stuck on You) (Lauria-Jackson)—Contralto, with Accomp. by Clarence Williams' Blue Seven Eva Taylor
- Scatter Your Smiles (Kortlander-Wendling)—Contralto, with Accomp. by Clarence Williams' Blue Seven Eva Taylor
- 8415 Wish I Had a Died in Egypt Land—Jubilee, with Piano Accomp. by Porter Grainger, Albertina-Victoria
- There's a Meetin' Here To-night—Jubilee, with Piano Accomp. by Porter Grainger, Albertina-Victoria
- 8416 Original Black Bottom Dance (Horsley-Bradford)—Fox-trot, with Chorus by Perry Bradford Perry Bradford and His Gang
- Kansas City Blues (Horsley)—Fox-trot, with Chorus by Perry Bradford, Perry Bradford and His Gang
- 8417 Five o'Clock Blues (Johnson)—Fiddle and Kazoo, with Banjo by James Johnson and Piano by DeLoise Searcy Lonnie Johnson
- Johnson's Trio Stomp (Johnson)—Fiddle and Piano Duet Lonnie Johnson-James Johnson
- 8418 Down Yonder Blues (Johnson)—Contralto, with Piano Accomp. by Bob Ricketts, Margaret Johnson
- Heavy Burden Blues (Perry)—Contralto, with Piano Accomp. by Bob Ricketts, Margaret Johnson

Gennett Records

POPULAR DANCE RECORDS

- 3404 Just a Little Longer—Fox-trot, with Vocal Specialty by Keller Sisters-Lynch, Willie Creager's Rhythm Aces
- Don't Sing Aloha When I Go—Fox-trot, with Vocal Specialty by Keller Sisters-Lynch, Willie Creager's Rhythm Aces
- 3405 Hello Bluebird—Fox-trot, with Vocal Chorus by Charles Forsythe Willie Creager's Rhythm Aces
- Tomboy Sue—Fox-trot, with Vocal Chorus by Charles Hart, Joe Candullo and His Everglades Orch.
- 3407 Toreador!—Fox-trot, with Vocal Chorus by Anthony Demish Felix Ferdinand and His Orch.
- Faustine—Fox-trot Jack Stillman's Orch.
- 3408 There's a Little White House (Where the Red, Red Roses Grow)—Fox-trot, with Vocal Chorus by Anthony Demish, Felix Ferdinand and His Orch.
- I'll Fly to Hawaii—Fox-trot, with Vocal Trio, Gowan's Rhapsody Makers
- 3409 My Baby Knows How—Fox-trot, with Vocal Chorus Felix Ferdinand and His Orch.
- In a Little Spanish Town—Waltz, Jose Garcia's Spanish Serenaders
- 3410 Leander—Fox-trot. Jose Garcia's Spanish Serenaders
- Gigolo—Fox-trot Jose Garcia's Spanish Serenaders

POPULAR VOCAL RECORDS

- 3411 I Meet Her in the Moonlight Myers-Nelson, with Accomp. by the Broadway Strollers
- Calling Me Home Myers-Nelson, with Accomp. by the Broadway Strollers
- 3412 Make Him Feel at Home Bert Lewis, of Club Kentucky, with Piano Accomp. by Jack Carroll
- Pretty Little Thing—Fox-trot Vaughn De Leath, with Instrumental Accomp. by Broadway Strollers

RACE AND SPANISH RECORDS

- 3406 Bobadilla—Fox-trot Jose Candullo y su orquesta
- Petrushka—Fox-trot Orquesta Gennett
- 3403 Lucky Number Blues (Slow Drag), Alberta Jones, with Accomp. by Ellington Twins
- I'm Gonna Put You Right in Jail (Slow Drag), Alberta Jones, with Accomp. by Ellington Twins

Pathe Phono & Radio Corp.

JANUARY RECORDS, NO. 1 DANCE RECORDS

- 36537 Here Comes Fatima—Fox-trot, with Vocal Chorus by Arthur Fields Van and His Orch.
- I Could Be Sweeter to My Sister's Sweetie—Fox-trot Miami Troupe
- 36538 I'd Love to Call You My Sweetheart—Fox-trot, Joe Candullo and His Everglades Orch.
- That Night in Araby—Fox-trot. Palace Garden Orch.
- 36539 All Alone Monday—Fox-trot, with Vocal Chorus by John Ryan, Joe Candullo and His Everglades Orch.
- When Day Is Done—Fox-trot, with Vocal Chorus by Lester O'Keefe, Nathan Glantz and His Orch.
- 36540 Don't Take That Black Bottom Away—Fox-trot, Stampede—Fox-trot, Joe Candullo and His Everglades Orch.
- 36541 Oh, How I Love Bulgarians—Fox-trot, with Vocal Chorus by John Ryan, Joe Candullo and His Everglades Orch.



"I've Grown So Lonesome - THINKING OF YOU"

The New Hit by Walter Donaldson and Paul Ash
Writers of "That's Why I Love You"

"PRECIOUS"

That Crisp and Crackling Fox Trot HIT!
by EGAN, PASTERNAKCI and WHITING

"TAKE IN THE SUN, HANG OUT THE MOON"

(ROCK ME IN A CRADLE OF DREAMS)

A Sure-fire Fox Trot Ballad With A Unique and Extraordinary Patter!
by LEWIS and YOUNG and HARRY WOODS

© 1926
LEO FEIST Inc

- Bolshevik—Fox-trot, with Vocal Chorus by John Ryan
- 36542 When You Waltz With the One You Love—Waltz
- To-night You Belong to Me—Waltz, with Vocal Chorus by L. O'Keefe
- 36543 Yiddish Charleston—Fox-trot-Charleston, Majestic Dance Orch.
- She Belongs to Me—Fox-trot, Palace Garden Orch.
- 25198 I Don't Mind Being All Alone—Vocal and Orch., Cliff Edwards and Hot Combination
- If You Can't Land 'er on the Old Verandah—Voice and Ukulele
- 32213 Cherie, I Love You—Instrumental Trio Accomp., Miss Annette Hanshaw
- Don't Take That Black Bottom Away—Vocal and Orch., Hanshaw and Red Heads
- 32215 I'd Love to Call You My Sweetheart—Voice and Piano, Willard Robison
- Hug and Kisses—Voice and Piano, Willard Robison
- 32214 Bring Back Those Minstrel Days—Vocal and Piano, Jack Kaufman-Al Campbell
- Sing, Katie, (But Leave the Piano Alone)—Voice and Piano, Kaufman-Campbell
- 32216 We Will Meet at the End of the Trail—Tenor, Vernon Dalhart
- The Crepe on the Old Cabin Door—Tenor, Vernon Dalhart

JANUARY RECORDS No. 2

- 36544 How Could Red Riding Hood—Fox-trot (Vocal Chorus by J. Ryan), Tommy Morton's Grangers
- Yours—Fox-trot (Vocal Chorus by Frank Bessinger), Hollywood Dance Orch.
- 36545 Sunday—Fox-trot, Lanin's Arcadians
- Look Up and Smile—Fox-trot (Vocal Chorus by J. Ryan), Lee Morse's Blue Grass Boys
- 36546 Just a Little Longer—Fox-trot (Vocal Chorus by W. Neff), Willard Robison and His Orch.
- Ev'rything's Peaches (For Peaches and Me)—Fox-trot, Morse's Blue Grass Boys
- 36547 My Baby Knows How—Fox-trot (Vocal Chorus by C. Kaley), Lanin's Arcadians
- After Hours "American Suite No. 1"—Fox-trot, Deep River Orch.
- 36548 Hello Bluebird—Fox-trot (Vocal Chorus by W. Neff), Willard Robison and His Orchestra
- Baby Mine (Fox-trot) (Vocal Chorus by Johnny Ryan), Tommy Morton's Grangers
- 36549 Broken Hearted—Fox-trot (Vocal Chorus by Charles Kaley), The Virginia Creepers
- When I Kissed You, I Kissed the Blues Good-Bye—Fox-trot, Morton's Grangers
- 36550 My Girl Has Eye Trouble—Fox-trot (Vocal Chorus by C. Kaley), The Virginia Creepers
- Cherita—Fox-trot (Vocal Chorus by Lester O'Keefe), Majestic Dance Orch.
- 36551 Hello! Swanee, Hello!—Fox-trot (Vocal Chorus by C. Kaley), The Virginia Creepers
- I Found a Million-Dollar Baby—Fox-trot (Vocal Chorus by A. Fields), Van and His Orch.
- 36552 Lonely Eyes—Fox-trot (Vocal Chorus by Charles Kaley), Lanin's Arcadians
- If I Only Believed in You—Fox-trot (Vocal Chorus by C. Kaley), Lanin's Arcadians
- 25199 Sunday—Voice and Orch., Cliff Edwards (Ukulele Ike) and His Hot Combination

Meadow Lark—Vocal and Orch., Cliff Edwards (Ukulele Ike) and His Hot Combination

- 32217 If You Can't Tell the World She's a Good Little Girl—Hanshaw and Red Heads
- I'm All Alone in a Castle of Stone—Vocal and Orch., Hanshaw and Red Heads
- 32218 She Knows Her "Onions"—Voice and Orch., Jay C. Flippen and His Gang
- How Could Red Riding Hood—Voice and Orch., Jay C. Flippen and His Gang
- POPULAR VOCAL RECORDS
- 32219 Just a Little Longer—Tenor, Irving Kaufman
- Rags—Tenor, Irving Kaufman
- 32220 When You're Away—Tenor, Vernon Dalhart
- The Prisoner's Sweetheart—Tenor, George Morbid
- 32221 I'm On My Way Home—Voice and Orch., Betty Morgan
- Talking to the Moon—Voice and Orch., Betty Morgan

CHRISTMAS RECORDS

- 21174 1. Adeste Fideles, 2. O Little Town of Bethlehem, 3. Hark! The Herald Angels Sing—Mixed Quartet, Orpheus Quartet
- 1. Silent Night, 2. It Came Upon the Midnight Clear—Orpheus Quartet

FOR CHILDREN

- 21176 At the Circus—Johnny Ryan
- Red Riding Hood Goes Singing—Johnny Ryan

Champion Two-hit Records

POPULAR DANCE RECORDS

- 15179 Hello Bluebird—Fox-trot, with Vocal Chorus, The Georgia Collegians

- Just a Little Longer—Fox-trot, with Vocal Chorus, The Georgia Collegians
- 15181 In a Little Spanish Town—Waltz, Fred Sharp's Royal Cubans
- Toreador!—Fox-trot, with Vocal Chorus, Fred Sharp's Royal Cubans
- 15182 There's a Little White House (Where the Red, Red Roses Grow)—Fox-trot, with Vocal Chorus, Fred Sharp's Royal Cubans
- Don't Sing Aloha When I Go—Fox-trot, with Vocal Chorus, The Georgia Collegians
- 15183 Don't Take That Black Bottom Away—Fox-trot, with Vocal Chorus, The Dancing Champions
- I'll Fly to Hawaii—Fox-trot, with Vocal Chorus, Fred Sharp's Royal Cubans
- 15184 I Still Believe in You—Fox-trot, with Vocal Chorus, The Dancing Champions
- My Baby Knows How—Fox-trot, with Vocal Chorus, Lakeshore Dance Orch.
- 15185 A Little Music in the Moonlight—Fox-trot, with Vocal Chorus, The Dancing Champions
- Gigolo—Fox-trot, Lakeshore Dance Orch.
- 15186 Leander—Fox-trot, Lakeshore Dance Orch.
- When Day Is Done—Fox-trot, with Vocal Chorus, Indiana Hotel Broadcasters

POPULAR VOCAL RECORDS

- 15178 I Found a Million-Dollar Baby—The Radio Franks
- Here Comes Fatima—Vaughn De Leath
- 15187 If My Baby Cooks (As Good as She Looks), Barney Smith (Of Hoosier Club)
- Make Him Feel at Home, Barney Smith (Of Hoosier Club)
- 15188 Susie's Feller, Barney Smith (Of Hoosier Club)
- Pretty Little Thing, Vaughn De Leath

CHRISTMAS SPECIALS

- 15042 Jingle Bells, Champion Quartet
- Adeste Fideles, Chimes and Brass Quintet
- 15045 Hark! The Herald Angels Sing, Champion Mixed Quartet
- Medley Christmas Airs, Trinity Orch.

STANDARD AND RACE RECORDS

- 15153 Anvil Chorus (From "Il Trovatore"), Champion Military Band
- Blue Danube Waltz, Champion Military Band
- 15161 Annie Laurie, Criterion Quartet
- Home, Sweet Home, Criterion Quartet
- 15180 Lucky Number Blues (Race Record), Alberta Jones
- I'm Gonna Put You Right in Jail (Race Record), Alberta Jones

Regal Records

DANCE RECORDS

- 8173 I've Got the Girl—Fox-trot, Al Lentz's Dance Orch.
- My Baby Knows How—Fox-trot, Imperial Dance Orch.
- 8174 I'm on My Way Home—Fox-trot, Sam Lanin's Dance Orch.
- I Love Her—Fox-trot, Hollywood Dance Orch.
- 8175 Moonlight on the Ganges—Fox-trot, Irwin Abrams' Dance Orch.
- Idolizing—Fox-trot, Hollywood Dance Orch.
- 8176 I'm Tellin' the Birds How I Love You—Fox-trot, Hollywood Dance Orch.
- If I'd Only Believed in You—Fox-trot, Hollywood Dance Orch.
- 8177 How Could Red Riding Hood?—Fox-trot, Al Lentz's Dance Orch.
- Gone Again Gal—Fox-trot, Al Lentz's Dance Orch.
- 8178 Hello Bluebird—Fox-trot, Sam Lanin's Dance Orch.
- Whose Little Sunshine Are You?—Fox-trot, Missouri Jazz Band
- 8179 There's a Little White House on a Little Green Hill—Fox-trot, Al, Lintz's Dance Orch.
- Hawaiian Kisses—Fox-trot, Imperial Dance Orch.
- 8180 Falling in Love With You—Waltz, Adrian Schubert's Salon Orch.
- Starlight—Waltz, Adrian Schubert's Salon Orch.
- 8181 There Ain't No Maybe in My Baby's Eyes—Fox-trot, Hollywood Dance Orch.
- Sunday—Fox-trot, Sam Lanin's Dance Orch.
- 8182 All Alone Monday (From "The Ramblers")—Fox-trot, Imperial Dance Orch.
- Hugs and Kisses (From "Earl Carroll's Vanities")—Fox-trot, Imperial Dance Orch.
- 8183 The Arkansaw Mule—Fox-trot, Ken Meyer's Novelty Trio
- Stampede—Fox-trot, Ken Meyer's Novelty Trio
- 8184 Hello! Swanee—Hello!—Fox-trot, Al Lentz's Dance Orch.
- Cheer Up—Fox-trot, Hollywood Dance Orch.
- 8185 The Little White House (From "Honeymoon Lane")—Fox-trot, Irwin Abrams' Dance Orch.
- Half a Moon (From "Honeymoon Lane")—Fox-trot, Imperial Dance Orch.

VOCAL RECORDS

- 8186 I'd Love to Call You My Sweetheart—Tenor Solo, Orch. Accomp., Irving Kaufman
- If Tears Could Bring You Back to Me—Bari-tone Solo, Orch. Accomp., Arthur Fields
- 8187 No One But You Knows How to Love—Con-tralto Solo, Piano Accomp., Evelyn Preer

- Sadie Green (The Vamp of New Orleans)—Con-tralto Solo, Piano Accomp., Evelyn Preer
- 8188 Calling Me Home—Tenor Solo, Orch. Accomp., Irving Kaufman
- Give Me a Ukulele—Male Duet, Piano Accomp., Radio Imps
- 8189 Just a Bird's-Eye View of My Old Kentucky Home—Tenor Solo, Piano Accomp., Charles Keene
- If My Baby Cooks (As Good as She Looks)—Male Duet, Piano Accomp., Hare-Jones
- 8190 The Crepe on the Old Cabin Door—Tenor Solo, Novelty Accomp., Vernon Dalhart
- Billy Richardson's Last Ride—Tenor Solo, Novelty Accomp., Vernon Dalhart
- 8191 Just a Little Longer—Tenor Solo, Piano Accomp., Charles Keene
- Humming Bird—Male Duet, Orch. Accomp., Hall-Ryan

- 8192 If You Can't Tell the World She's a Good Little Girl—Tenor Solo, Orch. Accomp., Irving Kaufman
- Broken Hearted Sue—Male Duet, Orch. Accomp., Hall-Ryan

HAWAIIAN RECORD

- 8193 Hawaiian Slumbertime—Duet, Hawaiian Guitars, Ferera-Paaluhi
- Somewhere in Honolulu—Duet, Hawaiian Guitars, Ferera-Paaluhi

IRISH RECORD

- 8194 The Hat Me Father Wore—Tenor Solo, Accomp. by Flanagan Bros., Matthew Haskins
- Highland Flings—Medley—Instrumental Trio, Flanagan Brothers

- 8195 Mary Lou—Banjo Solo, Vocal Refrain, Eddie Peabody
- Sweet Thing—Banjo Solo, Vocal Refrain, Eddie Peabody

RACE RECORD

- 8196 I'm Savin' It All for You—Comedienne, Jazz Band Accomp., Sara Johnson
- Papa if You Can't Do Better—Comedienne, Jazz Band Accomp., Sara Johnson
- 8197 Praying for the Pastor—Sermon with Choir, Rev. J. M. Gates
- After a While—Sermon with Choir, Rev. J. M. Gates

Cameo Records

DANCE RECORDS

- 1030 Beside a Garden Wall—Fox-trot, with Vocal Refrain, Bob Haring and His Orch.
- Life Will Be a Bed of Roses (If You Wake Up With a Smile)—Fox-trot, with Vocal Refrain, Bob Haring and His Orch.
- 1031 I'll Fly to Hawaii—Fox-trot, with Vocal Refrain, Bob Haring and His Orch.
- Moonlight Melody—Fox-trot, with Vocal Refrain, Cameo Dance Orch.
- 1038 For My Sweetheart—Fox-trot, with Vocal Refrain, Society Night Club Orch.
- Hello! Swanee, Hello!—Fox-trot, with Vocal Refrain, Ernie Golden and His Orch.
- 1039 Just a Little Longer—Fox-trot, with Vocal Refrain, Sam Lanin and His Troubadours
- I Meet Her in the Moonlight (But She Keeps Me in the Dark)—Fox-trot, with Vocal Refrain, Ernie Golden and His Orch.
- 1040 (I Just "Wanna" Be Known As) Susie's Feller—Fox-trot, with Vocal Refrain, Varsity Eight
- Usen't You Used to Be My Sweetie?—Fox-trot, with Vocal Refrain, Dixie Daisies
- 1041 In a Little Spanish Town ('Twas on a Night Like This)—Waltz, with Vocal Refrain, Society Night Club Orch.
- Hello, Bluebird—Fox-trot, with Vocal Refrain, Bob Haring and His Orch.

VOCAL RECORDS

- 1034 Stars (Are the Windows of Heaven)—Vocal Duet, with Piano Accomp., The Radio Franks (Wright-Bessinger)
- Let the End of the World Come To-morrow (As Long as You Love Me To-day)—Tenor Solo, with Orch. Accomp., William Robyn
- 1035 (I Just "Wanna" Be Known As) Susie's Feller—Vocal Blues, with Piano Accomp., Frances Sper Nola—Whistling Solo, with Piano and Violin Accomp., Cowboy Casey
- 1036 I Found a Million Dollar Baby (In a Five and Ten Cent Store)—Vocal Duet, with Piano Accomp., The Radio Franks (Wright-Bessinger)
- Pretty Birdie—Vocal Duet, with Piano Accomp., Kaufman-Campbell
- 1037 Black Bottom (From "George White's Scandals")—Vocal Duet, with Piano Accomp., The Ponce Sisters (Ethel and Dorothea)
- Someone Is Losin' Susan—Vocal Duet, with Piano Accomp., The Ponce Sisters (Ethel and Dorothea)
- 1042 My Baby Knows How—Vocal Blues, with Piano Accomp., Frances Sper

(Continued on page 144)

ADVANCE RECORD BULLETINS FOR JANUARY—(Continued from page 143)

- Meadow Lark—Vocal Duet, with Whistling, Kaufman-Campbell
- PIPE ORGAN RECORDS**
- 1032 To a Wild Rose—Pipe Organ Solo, Marsh McCurdy
Mighty Lak' a Rose—Pipe Organ Solo, Marsh McCurdy
- 1033 Adeste Fideles (Oh, Come All Ye Faithful)—Pipe Organ Solo, Marsh McCurdy
Holy Night! Peaceful Night—Pipe Organ Solo, Marsh McCurdy
- CHRISTMAS RECORDS**
- 1043 Christmas Tidings, Part 1—Male Voices, with Organ Accomp., Cathedral Male Choir
Christmas Tidings, Part 2—Male Voices, with Organ Accomp., Cathedral Male Choir
- 278 Holy Night! Peaceful Night—Male Quartet, Strand Male Quartet
- Adeste Fideles (Oh, Come All Ye Faithful)—Male Quartet, Strand Male Quartet
- 807 The Spirit of Christmas—Descriptive Novelty, Gloria Geer and Co.
Santa Claus at the Christmas Party—Descriptive Novelty, Gloria Geer and Co.

Harmony Records

- DANCE SELECTIONS**
- 304-H In a Little Spanish Town—Waltz, with Vocal Chorus by Joe Sherman, Tommy Christian and His Orch. 10
Ting-a-Ling—Waltz, with Vocal Chorus by Tony Pace, Tommy Christian and His Orch. 10
- 303-H It Made You Happy When You Made Me Cry—Fox-trot, with Vocal Chorus by Paul Hagan, The Astorites 10
(I've Grown So Lonesome) Thinking of You—Fox-trot, with Vocal Chorus by Paul Hagan, The Astorites 10
- 302-H Meadow Lark—Fox-trot, with Vocal Chorus by Tom Stacks, The Night Club Orch. 10
Hello! Swanee, Hello!—Fox-trot, with Vocal Chorus by Tom Stacks, The Night Club Orch. 10
- 299-H Off to Buffalo—Fox-trot, The Dixie Stompers 10
Brotherly Love—Fox-trot, The Dixie Stompers 10
- 298-H I Love the Moonlight—Fox-trot, with Vocal Chorus by Frank Bessinger, Broadway Bell Hops 10
If I'd Only Believed in You—Fox-trot, with Vocal Chorus by Irving Kaufman, Broadway Bell Hops 10
- 297-H I'm Tellin' the Birds—Tellin' the Bees—Fox-trot, with Vocal Chorus by Frank Bessinger, The Westerners 10
Take in the Sun, Hang Out the Moon—Fox-trot, with Vocal Chorus by Frank Bessinger, The Westerners 10
- 296-H My Baby Knows How—Fox-trot, with Vocal Chorus by Arthur Fields, University Six 10
Lonely Eyes—Fox-trot, University Six 10
- 293-H Fire!—Fox-trot, with Vocal Chorus by the Old Fireman, WMCA Broadcasters 10
Some Day—Fox-trot, WMCA Broadcasters 10
- 292-H Sidewalks of New York (East Side, West Side)—Waltz, with Vocal Chorus by Tony Pace, Joe Candullo and His Everglades Orch. 10
Will You Love Me in December as You Do in May?—Waltz, with Vocal Chorus by Tony Pace, Joe Candullo and His Everglades Orch. 10
- 291-H For My Sweetheart—Fox-trot, with Vocal Chorus by Irving Kaufman, The Harmonians 10
That's My Girl—Fox-trot, with Vocal Chorus by Irving Kaufman, The Harmonians 10
- 288-H Don't Take That Black Bottom Away—Fox-trot, Broadway Bell Hops 10
Sunday—Fox-trot, with Vocal Chorus by Jack Wilson, Broadway Bell Hops 10
- 286-H Brown Sugar—Fox-trot, Joe Candullo and His Everglades Orch. 10
Blowin' Off Steam—Fox-trot, Joe Candullo and His Everglades Orch. 10
- 285-H I Still Believe in You—Fox-trot, with Vocal Chorus by Happy Hour Trio, The Astorites 10
Tuck in Kentucky and Smile—Fox-trot, The Astorites 10
- VOCAL SELECTIONS**
- 301-H In a Little Spanish Town—Vocal, Irving Kaufman 10
To-night You Belong to Me—Vocal, Irving Kaufman 10
- 300-H I'm Tellin' the Birds—Tellin' the Bees How I Love You—Vocal, Jane Gray 10
I'd Love to Call You My Sweetheart—Vocal, Jane Gray 10
- 295-H Where Do You Work-a-John?—Vocal Duet, Jack Kaufman-Al Campbell 10
Bring Back Those Minstrel Days—Vocal Duet, Jack Kaufman-Al Campbell 10
- 294-H Rags—Vocal, with Phil Phillips at the Piano, Dolly Kay 10
Pretty Little Thing—Vocal, with Phil Phillips at the Piano, Dolly Kay 10
- 290-H I've Got the Girl!—Novelty Singing Quartet, The Harmonizers 10
Give Me a Ukulele—Novelty Singing Quartet, The Harmonizers 10
- 289-H Hello, Bluebird—Vocal, Jane Gray 10
What's the Use of Crying?—Vocal, Jane Gray 10
- HAWAIIAN SELECTIONS**
- 287-H Kona Waltz, Frank Ferera-John and Franzis Paaluh 10
In a Garden of Hawaii—Waltz, Frank Ferera-John and Franzis Paaluh 10

Banner Records

- DANCE RECORDS**
- 1860 Hello, Bluebird—Fox-trot, Sam Lanin's Troubadours
If I'd Only Believed in You—Fox-trot, Imperial Dance Orch. 10
- 1861 There's a Little White House on a Little Green Hill—Fox-trot, Al Lentz's Dance Orch. 10
Gone Again Gal—Fox-trot, Al Lentz's Dance Orch. 10
- 1862 I'm on My Way Home—Fox-trot, Sam Lanin's Troubadours
Cheer Up—Fox-trot, Imperial Dance Orch. 10
- 1863 How Could Red Riding Hood?—Fox-trot, Al Lentz's Dance Orch. 10
My Baby Knows How—Fox-trot, Missouri Jazz Band 10
- 1864 I'm Tellin' the Birds, How I Love You—Fox-trot, Imperial Dance Orch. 10
I Love Her—Fox-trot, Missouri Jazz Band 10
- 1865 Falling in Love With You—Waltz, Adrian Schubert's Salon Orch. 10
Starlight—Waltz, Adrian Schubert's Salon Orch. 10
- 1866 Hello! Swanee, Hello!—Fox-trot, Al Lentz's Dance Orch. 10
Whose Little Sunshine Are You?—Fox-trot, Imperial Dance Orch. 10
- 1867 The Little White House (From "Honeymoon Lane")—Fox-trot, Irwin Abrams' Dance Orch. 10

- Half a Moon (From "Honeymoon Lane")—Fox-trot, Hollywood Dance Orch. 10
- 1868 I've Got the Girl—Fox-trot, Al Lentz's Dance Orch. 10
Sunday—Fox-trot, Sam Lanin's Troubadours 10
- 1869 Moonlight on the Ganges—Fox-trot, Irwin Abrams' Dance Orch. 10
- 1870 Hawaiian Kisses—Fox-trot, Hollywood Dance Orch. 10
Idolizing—Fox-trot, Hollywood Dance Orch. 10
There Ain't No Maybe in My Baby's Eyes—Fox-trot, Missouri Jazz Band 10
- 1871 All Alone Monday (From "The Ramblers")—Fox-trot, Hollywood Dance Orch. 10
Hugs and Kisses (From "Earl Carroll's Vanities")—Fox-trot, Hollywood Dance Orch. 10
- 1872 Stampede—Fox-trot, Ken Meyer's Novelty Trio 10
The Arkansas Mule—Fox-trot, Ken Meyer's Novelty Trio 10
- VOCAL RECORDS**
- 1873 Sadie Green (The Vamp of New Orleans)—Contralto Solo, with piano Accomp., Evelyn Preer 10
No One But You Knows How to Love—Contralto Solo, with piano Accomp., Evelyn Preer 10
- 1874 Just a Bird's-eye View of My Old Kentucky Home—Tenor Solo, with piano Accomp., Charles Keene 10
Just a Little Longer—Tenor Solo, with piano Accomp., Charles Keene 10
- 1875 Give Me a Ukulele—Male Duet, with piano Accomp., The Radio Imps 10
If My Baby Cooks (As Good as She Looks)—Male Duet, with piano Accomp., Hare-Jones 10
- 1876 I'd Love to Call You My Sweetheart—Tenor Solo, with Orch. Accomp., Irving Kaufman 10
Humming Bird—Male Duet, with Orch. Accomp., Hall-Ryan 10
- 1877 Calling Me Home—Tenor Solo, with Orch. Accomp., Irving Kaufman 10
If Tears Could Bring You Back to Me—Baritone Solo, with Orch. Accomp., Arthur Fields 10
- 1878 If You Can't Tell the World She's a Good Little Girl—Tenor Solo, with Orch. Accomp., Irving Kaufman 10
Broken Hearted Sue—Male Duet, with Orch. Accomp., Hall-Ryan 10
- 1879 The Crepe on the Old Cabin Door—Tenor Solo, with Novelty Accomp., Vernon Dalhart 10
Billy Richardson's Last Ride—Tenor Solo, with Novelty Accomp., Vernon Dalhart 10
- 1880 Mary Lou—Banjo Solo, with Vocal Refrain, Eddie Peabody 10
Sweet Thing—Banjo Solo, with Vocal Refrain, Eddie Peabody 10
- HAWAIIAN RECORD**
- 2137 Somewhere in Honolulu—Duet, with Hawaiian Guitars, Ferera-Paaluh 10
Hawaiian Slumbertime—Duet, with Hawaiian Guitars, Ferera-Paaluh 10
- IRISH RECORD**
- 2138 The Hat Me Father Wore—Tenor Solo, with Accomp. by Flanagan Brothers, Matthew Haskins 10
Highland Flings—Medley—Instrumental Trio, Flanagan Brothers 10
- RACE RECORDS**
- 1881 After Awhile—Sermon, with Choir, Rev. J. M. Gates 10
Praying for the Pastor—Sermon, with Choir, Rev. J. M. Gates 10
- 1882 Papa If You Can't Do Better—Comedienne, with Jazz Band Accomp., Sara Johnson 10
I'm Savin' It All for You—Comedienne, with Jazz Band Accomp., Sara Johnson 10

Emerson Records

- DANCE RECORDS**
- 3077 Falling in Love With You—Waltz, Marlborough Dance Orch. 10
Take It From Me, Pennsylvania Syncopators 10
I Can't Get Over a Girl Like You, Marlborough Dance Orch. 10
- 3079 How I Love You, Kaplan and His Orch. 10
My Baby Knows How, Original Indiana Five 10
Cow Bell Blues, Original Indiana Five 10
- 3080 If I Only Believed in You, Kaplan and His Orch. 10
I'd Rather Be the Girl in Your Arms, Marlborough Dance Orch. 10
- 3081 In a Little Spanish Town, Kaplan and His Orch. 10
If Tears Could Bring You Back to Me, Stillman and His Orioles 10
- 3082 Gone Again Gal, Stillman and His Orioles 10
Here Comes Fatima, F. Hall and His Orch. 10
- VOCAL RECORDS**
- 3083 Just a Little Longer, Charles Hart 10
Hello, Bluebird, Arthur Fields 10
Hello! Swanee, Hello!, Arthur Fields 10
Wonderful Waltz of Love, Charles Hart 10
- 3085 Hum Your Troubles Away, Emerson Quartet 10
Take in the Sun, Hang Out the Moon, Emerson Quartet 10
- 3086 Six Feet of Papa, Gertrude Dwyer 10
A Too Tame Papa, Gertrude Dwyer 10

Domino Records

- DANCE RECORDS**
- 3832 Hello, Bluebird—Fox-trot, Sam Lanin's Troubadours
If I'd Only Believed in You—Fox-trot, Imperial Dance Orch. 10
- 3840 There's a Little White House on a Little Green Hill—Fox-trot, Al Lentz's Dance Orch. 10
Gone Again Gal—Fox-trot, Al Lentz's Dance Orch. 10
- 3835 I'm on My Way Home—Fox-trot, Sam Lanin's Troubadours
Cheer Up—Fox-trot, Imperial Dance Orch. 10
- 3831 How Could Red Riding Hood?—Fox-trot, Al Lentz's Dance Orch. 10
My Baby Knows How—Fox-trot, Missouri Jazz Band 10
- 3833 I'm Tellin' the Birds, How I Love You—Fox-trot, Imperial Dance Orch. 10
I Love Her—Fox-trot, Missouri Jazz Band 10
- 3837 Falling in Love With You—Waltz, Adrian Schubert's Salon Orch. 10
Starlight—Waltz, Adrian Schubert's Salon Orch. 10
- 3834 Hello! Swanee, Hello!—Fox-trot, Al Lentz's Dance Orch. 10
Whose Little Sunshine Are You?—Fox-trot, Imperial Dance Orch. 10
- 3842 The Little White House (From "Honeymoon Lane")—Fox-trot, Irwin Abrams' Dance Orch. 10
Half a Moon (From "Honeymoon Lane")—Fox-trot, Hollywood Dance Orch. 10
- 3839 I've Got the Girl—Fox-trot, Al Lentz's Dance Orch. 10
Sunday—Fox-trot, Sam Lanin's Troubadours 10
- 3836 Moonlight on the Ganges—Fox-trot, Irwin Abrams' Dance Orch. 10
Hawaiian Kisses—Fox-trot, Hollywood Dance Orch. 10
- 3843 Idolizing—Fox-trot, Hollywood Dance Orch. 10
There Ain't No Maybe in My Baby's Eyes—Fox-trot, Missouri Jazz Band 10
- 3838 All Alone Monday (From "The Ramblers")—Fox-trot, Hollywood Dance Orch. 10

- Hugs and Kisses (From "Earl Carroll's Vanities")—Fox-trot, Hollywood Dance Orch. 10
- 3841 Stampede—Fox-trot, Ken Meyer's Novelty Trio 10
The Arkansas Mule—Fox-trot, Ken Meyer's Novelty Trio 10
- VOCAL RECORDS**
- 3846 Sadie Green (The Vamp of New Orleans)—Contralto Solo, with piano Accomp., Evelyn Preer 10
No One But You Knows How to Love—Contralto Solo, with piano Accomp., Evelyn Preer 10
- 3844 Just a Bird's-eye View of My Old Kentucky Home—Tenor Solo, with piano Accomp., Charles Keene 10
Just a Little Longer—Tenor Solo, with piano Accomp., Charles Keene 10
- 3849 Give Me a Ukulele—Male Duet, with piano Accomp., The Radio Imps 10
If My Baby Cooks (As Good as She Looks)—Male Duet, with piano Accomp., Hare-Jones 10
- 3845 I'd Love to Call You My Sweetheart—Tenor Solo, with Orch. Accomp., Irving Kaufman 10
Humming Bird—Male Duet, with Orch. Accomp., Hall-Ryan 10
- 3848 Calling Me Home—Tenor Solo, with Orch. Accomp., Irving Kaufman 10
If Tears Could Bring You Back to Me—Baritone Solo, with Orch. Accomp., Arthur Fields 10
- 3847 If You Can't Tell the World She's a Good Little Girl—Tenor Solo, with Orch. Accomp., Irving Kaufman 10
Broken Hearted Sue—Male Duet, with Orch. Accomp., Hall-Ryan 10
- 3850 The Crepe on the Old Cabin Door—Tenor Solo, with Novelty Accomp., Vernon Dalhart 10
Billy Richardson's Last Ride—Tenor Solo, with Novelty Accomp., Vernon Dalhart 10
- 3851 Mary Lou—Banjo Solo, with Vocal Refrain, Eddie Peabody 10
Sweet Thing—Banjo Solo, with Vocal Refrain, Eddie Peabody 10
- HAWAIIAN RECORD**
- 0166 Somewhere in Honolulu—Duet, with Hawaiian Guitars, Ferera-Paaluh 10
Hawaiian Slumbertime—Duet, with Hawaiian Guitars, Ferera-Paaluh 10
- IRISH RECORD**
- 0165 The Hat Me Father Wore—Tenor Solo, with Accomp. by Flanagan Brothers, Matthew Haskins 10
Highland Flings—Medley—Instrumental Trio, Flanagan Brothers 10
- RACE RECORDS**
- 3853 After Awhile—Sermon, with Choir, Rev. J. M. Gates 10
Praying for the Pastor—Sermon, with Choir, Rev. J. M. Gates 10
- 3852 Papa If You Can't Do Better—Comedienne, with Jazz Band Accomp., Sara Johnson 10
I'm Savin' It All for You—Comedienne, with Jazz Band Accomp., Sara Johnson 10

U. S. Music Co.

- WORD ROLLS**
- Title Played by
- If I'd Only Believed in You—Fox-trot, Robert Billings
Senorita Mine ("Tan Town Topics Revue")—Fox-trot, Jack Pierce
- Climbing Up the Ladder of Love—Fox-trot, Jack Pierce
Hugs and Kisses ("Vanities")—Fox-trot, Robert Billings
How I Love You—Fox-trot, Robert Billings
My Baby Knows How—Fox-trot, Jack Pierce
Hello Bluebird—Fox-trot, Robert Billings
Rainbow of Waikiki—Waltz, Robert Billings
Hush-a-Bye—Waltz, Harold Wansborough
Where Do You Work-a-John?—Song, Harold Wansborough
Trouble in Mind Blues, Jack Pierce
If I Had You—Waltz, Harold Wansborough
Rags—Fox-trot, Lee Sims
Just a Little Longer—Fox-trot, Lee Sims
Thinking of You—Fox-trot, Lee Sims
Idolizing—Fox-trot, Lee Sims
I'm Looking for a Girl Named Mary—Waltz, Lee Sims
Kentucky Lullaby—Waltz, Lee Sims
There Ain't No Maybe in My Baby's Eyes—Fox-trot, Robert Billings
- For You and Me—Fox-trot, Jack Pierce
I've Got the Girl—Fox-trot, Robert Billings
Tell Me To-night—Fox-trot, Robert Billings
It Made You Happy When You Made Me Cry—Fox-trot, Lee Sims
Pal of My Lonesome Hours—Fox-trot, Lee Sims
- INSTRUMENTAL ROLLS—MUSIC ONLY**
- Dizzy Fingers, Lee Sims
- AUTO-ART**
- These Rolls for Reproducing and Expression Player-Pianos Using Standardized Tracker Bar
- WORD ROLLS**
- Carmena—Waltz Song, McNair Ilgenfritz
INSTRUMENTAL ROLLS—MUSIC ONLY
- Annie Laurie—With Variations, McNair Ilgenfritz
Verum? (Why) (Schumann), McNair Ilgenfritz
Vogel als Prophet (The Prophet Bird) (Schumann), McNair Ilgenfritz
Viennese Waltz (Paraphrase), McNair Ilgenfritz
Mignon—Selections (Amhrose Thomas), McNair Ilgenfritz
Mazurka—(Op. 33, No. 2) (Chopin), McNair Ilgenfritz
Salut D'Amour (Love's Greeting) (Elgar), McNair Ilgenfritz
- LIBRARY EDITION—WORD ROLLS**
- I Passed by Your Window—Song, Robert Billings
- FOREIGN WORD ROLLS**
- Acht Wspomnij Mie—Walc (Polish)
Dziewcze Z Buzia Jak Malina (Polish)
Mylkie Tevnye (Lithuanian)
Gdy Pierwszy Raz Ja Ujrzałem—Walc
FOREIGN ROLLS—MUSIC ONLY
- Obertas Staropolis (Polish)
Edzia—Polka (Polish)
Setka Polka
Kurpik Oberek
Samochod Polka (Polish)

Hoffman Music Co.'s Store Is Remodeled

CLINTON, LA., December 4.—The fiftieth anniversary of the Hoffman Music Co. was celebrated last month with the formal opening of the greatly enlarged and completely remodeled three-story building which houses the concern. A complete line of all musical instruments is carried. A musical program was given during the opening day and appropriate souvenirs were distributed to visitors.

From European Headquarters

(Continued from page 139)

Holland and New Zealand have been converted into limited liability companies, and that a new company has been formed in Germany. The company holds shares to the value of £121,000-odd in these new companies. Referring to general conditions, the chairman said that the sales of the first four months of the new financial year were far in excess of those for the corresponding months of the previous year, and all indications tended to show that the comparative sales are likely to continue upward.

The Pearlitone Diaphragm

L. E. Jaccard, of Clerkenwell road, this city, has recently introduced to the trade a new novelty in the shape of a delicately and artistically designed diaphragm, which, used with just a motor and turntable, attached to any box or cabinet, precludes the use of the ordinary sound box, tone arm and amplifying chamber.

Brief Paragraphs of Interest

The Eighth Belgian Official Commercial and International Fair is announced to be held April 7 to 21, inclusive, in the Gardens and Halls of the Cinquantenaire, Brussels. Talking machine firms that have already booked space include Compagnie Francaise du Gramophone, Compagnie du Phono-Colibri, of Belgium (pocket portables), C. De Sauw, of Brussels, Pathé Belgique, G. Reney, of Brussels, and Hermann Thorens, of Switzerland (motors).

The annual dinner of the Federation of British Music Industries is announced to be held on January 26, 1927, at the Savoy Hotel. The 1927 convention, I understand, is to be held toward the end of May in Ramsgate.

Louis Sterling is daily expected (as I write) back from New York. Anticipations are always rife upon Mr. Sterling's appearances and disappearances, and the trade would not be at all surprised if Columbia announced some new and big Columbia effort upon his return.

Evidence of the increasing activity of the trade here is afforded by the fact that both Collaro, Ltd., and the Garrard Engineering Co. have had to secure additional premises. Messrs. Collaro have secured a new and larger factory at Culmore Works, Culmore road, Peckham, London, and the Garrard Co.'s works at Swindon have been further extended recently.

Edison Concert Given

PEEKSKILL, N. Y., December 9.—A comparison concert featuring the New Edison phonograph and entitled "The Romance of Music" with Helen Davis, soprano and Victor Young, pianist, both Edison artists, appearing in costume, was given at Drum Hill auditorium, under the auspices of Petrocine's Music Store, on December 6. The event was well attended.

The Pacific Motor Supply Co., of San Francisco and Los Angeles, Cal., recently was appointed distributor in California for Erla receivers by the Electrical Research Laboratories, of Chicago, Ill.

CONSTRUCTIVE ARTICLES IN THIS ISSUE OF THE WORLD

Ready Reference for Salesmen, Dealers and Department Heads

Important European-American Deals Have Been Consummated by the Brunswick Co.	3	Featuring the Musical Possibilities of the Talking Machine	42
New York Bankers Secure Control of the Victor Talking Machine Co.	3	Radio Tie-ups With Important Events Build Sales	46
Greater Profits by Exploiting New Records	4	Broadcasting Situation Receives the Attention of Metropolitan Retailers	56
W. H. Lynas Makes Interesting Analysis of Status of Radio Industry in Europe	6	Roy E. Forbes Tells How the Victor Co. Introduced Orthophonic Line to the Trade	60
Interesting Facts Concerning Radio's Missing Notes	8	Metropolitan Victor Dealers Plan Publicity Drive in Behalf of Orthophonic	78
Straightening Out the Air Tangles	10	J. G. Harbord Discusses Radio Broadcasting	83
It's the Effort, Not the Market That Fails	10	New Stores and Changes Among Talking Machine Dealers During the Past Month	96-98
Authoritative Information Is Important Closing the Books for Nineteen Hundred and Twenty-six	10	Radio Co-ordinating Committee Urges Emergency Control Measure	110
Keeping the Mailing List Alive	11	"Radiano" Makes Its Debut in the Twin Cities	113
An Outstanding Business Transaction "Cheap Credit" Causes Collection Troubles	12	Columbia Graphophone Co., Ltd., Bids for Minority Stock of American Co.	116
Co-operative Ads Score Over Sales Resistance	14	Tie-ups With the Recording Artists— Concert Dates That Present an Opportunity for Profit to Dealers. In the Musical Merchandise Field.	123-127
Goggan's Idea Exchange Plan Aids Selling	16	National Musical Instrument Manufacturers Offer First of Series of Dealers' Sales Aids	123
Consolidated Co., Baltimore, Utilizing Big Business Methods to Sell the Brunswick Line	19	Attributes Big Sales to Co-operation With Schools	124
Money-Making Suggestions for Ambitious Merchants	20	How Snyder Music Store Conducts Small Goods Department to Bring Big Profits	125
Stress Radio Service, Not Price, Say Lyon & Healy	22	Celebration Features Production of the Millionth Atwater Kent Receiving Set	129
A Budget of Profit Winning Sales Wrinkles	24	Seeking New Legislation Covering Postal Activities	130
Let the Post Office Check Your Mailing List	26	Gleanings From the World of Music	135-138
Long-Term Instalment Selling Is Bad Practice	28	Music Publishing Firms Report Output That Is Valued at \$15,089,636 in 1925	135
An Intelligently Selected Sideline Eliminates Periods of Trade Depression	30	Production Music and the Way in Which It Increases Sales for the Merchant	138
Matthews Outside Selling Brought Results	32	Advance Lists of Talking Machine Records	141-144
Salesmanship in the Record Department Is Essential to Its Profitable Operation	35		
Opportunity for Trade to Tie Up With National Drive of Piano Manufacturers	38		

CORRESPONDENCE FROM LEADING CITIES

St. Louis, 50—Minneapolis and St. Paul, 51—Cincinnati, 52—New York, 54—Richmond, 58—Akron-Canton, 58—Milwaukee, 59—Toledo, 67—Kansas City, 70—Cleveland, 72—Los Angeles, 75—Buffalo, 80—Boston, 82—Detroit, 84—Pittsburgh, 86—Philadelphia, 88-92—Chicago, 101-111—Baltimore, 114—News From The World's European Office, 139—Canada, 140.



PHONOGRAPH CASES RADIO CASES

Reinforced 3-ply Veneer

The Standard Case for Talking Machines and Radio Sets

Let us figure on your requirements

MADE BY
PLYWOOD CORPORATION, Goldsboro, N. C.

Mills in Va., N. C. and S. C.

MANUFACTURERS OF RADIO and PHONOGRAPH HARDWARE
Write—Star Machine & Novelty Co., 9-11 Watsessing Ave., Bloomfield, N. J.

Chanslor & Lyon, Los Angeles, with branches throughout the State, have been appointed the exclusive California distributor for Zenith radio receivers.

TEST IT.

OUR VICTOR



Record Service

has a reputation for efficiency.
Suppose you try it.

E. F. DROOP & SONS CO.

1300 G. STREET, WASHINGTON, D. C.
204-6-8-10 CLAY STREET, BALTIMORE, MD.

INDEX TO ADVERTISERS

A

Algonquin Elec. Co. 115

Alter & Co., Harry 104

Alto Mfg. Co. 102

American Bosch Magneto Corp. 39

American Electric Co., Inc. 109

American Mica Works. 131

Amplion Corp. of America. 27

Amrad Corp. 64

Andrea, Inc., F. A. D. 65

Apex Elec. Mfg. Co. 55

Argus Radio Corp. 133

Atlas Plywood Corp. 34

Atwater Kent Mfg. Co. 48, 49

Audak Co. Insert facing page 58

B

Bacon Banjo Co. 122

Baltimore Phono. Distributing Co. 72

Barker Wholesale Co. 72

Bell & Howell. Insert facing page 50

Berg Auto Trunk & Specialty Co. 83

Berlin, Inc., Irving. 136

Birnback Radio Co. 128

Blackman Talking Machine Co. Insert facing page 34

Borkman Radio Corp. 43

Boudette Mfg. Co. 56

Brach Mfg. Co., L. S. 57

Brilliantone Steel Needle Co. 85

Bruno & Son, Inc., C. 9, 123

Brunswick-Balke-Collender Co. Front Cover 5, 41

Buegeleisen & Jacobson. 126

Buescher Band Instrument Co. 18

Burke Co., J. H. 72

C

Carryola Co. of America. Insert between pages 42 and 43

Caswell Mfg. Co. 95

C. E. Mfg. Co. 42

Champion Record Co. Inside back cover

Claremont Waste Mfg. Co. 130

Classified Want Ads. 130

Columbia Phonograph Co., Inc. Insert facing page 10

Columbia Wholesalers, Inc. 114, 132

Commercial Associates. 72

Consolidated Talking Machine Co. 87, 100, 102

Crosley Radio Corp. 61

D

Ditson & Co., Chas. H. 82

Ditson & Co., Oliver. 82

Doerr-Andrews-Doerr. 72

Droop & Sons Co., E. F. 145

E

Eckhardt Corp. 121

Edison, Inc., Thos. A. Back cover

Electrical Research Laboratories. 107

Emerson Records. 66

Empire Phono. Parts Co. Insert facing page 42

Excel Phonograph Co. 75

F

Fansteel Products Co. 21

Farrand Mfg. Co. 33

Federal-Brandes Corp. 44, 45

Federal Radio Co. 23

Feist, Leo, Inc. 135, 137, 141, 143

Fischer Co., J. A. Insert facing page 26

Fox Pub. Co., Sam. 138

Freshman Co., Chas. 113

Fuehr & Stemmer Piano Co. 110

G

General Elec. Co. 94

Gibson-Snow Co., Inc. 72

Gilfillan Bros., Inc. 28

Gold Seal Electrical Co. 47

Gould Storage Battery Co. 89

Greater City Phonograph Co. 72

Grigsby-Grunow-Hinds Co. 15

Guarantee T. M. Supply Co. 90

Guden & Co., H. A. 32

H

Hassler Texas Co. 72

Hastings Elec. Sales Co. 56

Hazeltine Corp. 63

Hohner, Inc., M. 124

Hygrade Case Co. 127

I

Ideal Phono. Parts Co. 118

Ilsley, Doubleday & Co. 116

Independent Radio Mfrs. Corp. 63

Indiana Mfg. & Elec. Co. 6

International Mica Co. 46

J

Jacobs, C. E. 108

Jewell Elec. Inst. Co. 62

Jewel Phonoparts Co. 103

Jones, Howard B. 72

K

Kellogg Switchboard & Supply Co. 99

Kent Co., F. C. 30

Kimball Co., W. W. 101

Kohler Distributing Co. 72

L

Leedy Mfg. Co. 127

Ludwig & Ludwig. 124

M

Magnavox Co. 26

Marks Music Co., Edw. B. 136

Mikiphone, S. A. 35

Minerva Radio Co. 132

Mohawk Corp. of Illinois. 31

Moore-Bird Co. 72

Mu-Rad Corp. 22

Music Master Corp. 78

Mutual Phono. Parts Mfg. Co. 117

N

National Carbon Co. 29

National Lead Battery Co. 81

National Lock Co. 24

National Publishing Co. 11

New York Album & Card Co. 4

Nonaka Trading Co. 76

O

Okeh Phonograph Corp. 74, Insert facing page 18

Okeh Phonograph Corp. (New York Distributing Division) 80

Oro-Tone Co. 109

P

Pacent Radio Co. 40

Pathe Radio & Phono. Co. 119

Pausin Engg. Co. 73

Peckham Mfg. Co. 131

Peerless Album Co. 8

Pennsylvania Phono. Dist. Co. 72

Perophone Co. 139

Perryman Elec. Co. 25

Philadelphia Badge Co. 92

Philadelphia Victor Distributors. 88

Pierson Co. 112

Plaza Music Co. Insert between pages 34 and 35

Plywood Corp. 145

Polk Co., Inc., James K. 72

Pollack-Welker, Ltd. 116

Priess Radio Co. 50

Q

Quincke & Co., W. A. 138

Q R S Music Co. 84

R

Radio Corp. of America. 36, 37

Reach Textile Co., A. L. 54

Reliance Battery Products Co. 72

Rene Manufacturing Co. 140

Richards, Inc., C. A. 72

Rockford Sales Corp. Insert between pages 58 and 59

Rudell, Jos. E. 43

S

Saal Co., H. G. 129

Sandar Corp. 79

Schubert, G. H. 110

Scully, John J. 117

Shamrock Mfg. Co. 71

Showers Bros. Co. 77

Silent Motor Corp. 17, 131

Slagle Radio Corp. 97

Sleeper Radio & Mfg. Corp. Insert facing page 35

Smith Co., C. D. 72

Sonatron Tube Co. 106

Sonora Phonograph Co., Inc. Inside front cover, 52, 68, 69

Spartan Elec. Co. 111

Star Machine & Nov. Co. 145

Starr Piano Co. 14

Stead & Co., Ltd., J. 51, 60

Sterling Mfg. Co. 120

Sterling Roll & Record Co. 72

Stevens & Co. 93

Strevell-Paterson Hdw. Co. 72

Stromberg-Carlson Telephone Mfg. Co. 7

Superior Phono. Parts Co. 98

Symphonic Sales Co. 53

T

Talking Machine Supply Co. 130

Targ & Dinner Music Co. 108

Tay Sales Co. 72

Tectron Radio Sales Corp. 130

Teletone Corp. of America. 134

Televocal Corp. 59

Thorens, Hermann. 20

Toman & Co., E. 70

Tower Mfg. Co. 46

Trilling & Montague. 90

U

Udell Works. 86

Unique Reproduction Co., Inc. Insert facing page 42

United Mfg. & Distr. Co. 104

United Scientific Laboratories. 131

Utah Radio Products Co. 105

V

Van Veen & Co., Inc. 76

Vega Co. 125

W

Wall-Kane Needle Mfg. Co. 112

Wasmuth Goodrich Co. 95

Weber-Rance Corp. 38

Weston Elec. Inst. Corp. 16

Weymann & Son, H. A. 92, 127

White Co., H. N. 13

Windsor Furniture Co. 91

W-K Electric Co. 19

Wolf Mfg. Inds. 67

Wondertone Phono. Co. 70

Y

Yahr-Lange, Inc. 128

Zenith Radio Corp. Insert facing page 59

Zinke & Co. 19, 43

CHAMPION

**ELECTRICALLY
RECORDED**

POPULAR PRICED

**TWO-HIT
RECORDS**

PERFECT REPRODUCTION ON ALL
PHONOGRAPHS

The Champion Two-Hit Record

HAS been on the market less than one year and the increase in sales volume from month to month per dealer proves beyond a doubt its qualifications meeting the present day demands of selling organizations, regardless of size.

The Champion Record Department Merchandising plan as outlined to the trade has met with unlimited success as it increases sales and reduces the overhead in many ways. Write today for details concerning this new record.

CHAMPION RECORD COMPANY

RICHMOND, INDIANA



How

Thomas A Edison

is putting the Phonograph back on the map

ON November 20th, Thomas A. Edison told nearly three million readers of The Saturday Evening Post why the phonograph will continue to hold its place in the American home. He is telling them about his wonderful new instrument, the Long-Playing Phonograph. He will tell them again in the December 11th issue of the same magazine.

The November 27th issue of Collier's Weekly carried his first message to its nearly two million readers. And then on December 11th, just two weeks before Christmas, at the very peak of the holiday buying, Collier's Weekly will carry across its center spread a great color smash.

Meanwhile, the farm and small town population—more than two and one-half million people—will read about Thomas A. Edison's latest achievement. The same news will be carried again by three separate insertions in more than a hundred newspapers—another three million readers.

Ten and a half million people—phonograph prospects—reading once, and most of them twice, about the great improvement that Thomas A. Edison has made in one of the first of his inventions. Ten and a half million prospects—enough in every town and city to make a sizable increase for every Edison dealer.

THOMAS A. EDISON, Inc.
Orange, N. J.

Jobbers of the New Edison:

NEW YORK
Albany—American Phonograph Co.

OHIO
Cleveland—The Phonograph Co.

PENNSYLVANIA
Philadelphia—Girard Phonograph Co.
Williamsport—W. A. Myers

TEXAS
Dallas—Texas-Oklahoma Phonograph Co.

UTAH
Ogden—Proudfit Sporting Goods Co.

VIRGINIA
Richmond—The C. B. Haynes Co., Inc.

CANADA
St. John—W. H. Thorne & Co., Ltd.
St. Thomas—Edison Phonograph Distrib. Co.
Vancouver—Kent Piano Co., Ltd.

CALIFORNIA
San Francisco—Edison Phonograph Dist. Co.

COLORADO
Denver—Edison Phonograph Distributing Co.

GEORGIA
Atlanta—Phonographs, Inc.

ILLINOIS
Chicago—Edison Phonograph Distributing Co.

LOUISIANA
New Orleans—Diamond Music Co., Inc.

MICHIGAN
Detroit—The R. B. Alling Co.

MISSOURI
Kansas City—Edison Phonograph Dist. Co.
St. Louis—Silverstone Music Co.

MONTANA
Helena—Montana Phonograph Co.

NEW JERSEY
Orange—Edison Phonograph Distributing Co.

