

January 1947

# Television

THE BUSINESS MAGAZINE OF THE INDUSTRY

January

35¢

1948 70 STATIONS  
1,350,000 RECEIVERS

1947 25 STATIONS  
350,000 RECEIVERS

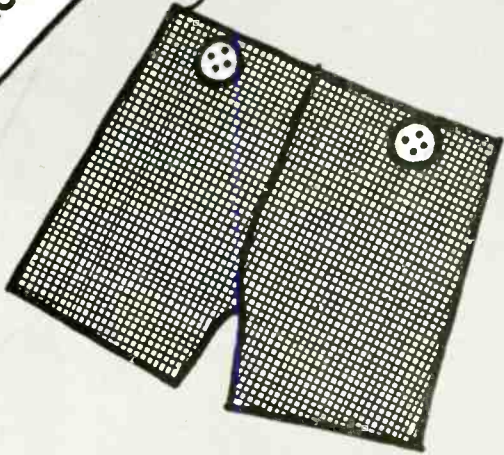

1946 9 STATIONS  
20,000 RECEIVERS

# In Production!



## G. E.'s NEW 5-KW TELEVISION TRANSMITTER

COMPLETELY self-contained, General Electric's new 5-kw television transmitter combines every modern improvement for producing the finest pictures and sound that money can buy. Built-in sweep oscillators and crystal monitors make circuit adjustments easy for any operator. Plate modulation assures maximum modulation linearity. Elimination of vestigial side-band filter increases power-amplifier efficiency. New type power-amplifier triodes in push-pull, grounded

grid circuit do away with neutralization and grid "swamping" resistors, speed up tube replacement, and cut tube costs. Important advancements like these are your assurance of unmatched program reliability, ease of control and maintenance, and lower operating cost.

See your G-E broadcast sales engineers for complete technical specifications or write today to the *Electronics Department, General Electric Company, Syracuse 1, New York.*

### Higher-contrast pictures

Low-level plate modulation for greater modulation linearity over the full visual range. Video pre-emphasis unnecessary.

### New advancements in circuit simplicity

Flat band-pass over full range • No vestigial sideband filter • FM sound transmitter designed with the famous Phasitron modulator • D-C insertion at low level.

### Higher circuit efficiency

Pre-output shaping of vestigial side-band reduces power amplifier bandwidth 40 per cent—improves power amplifier efficiency • No power-wasting "swamping" resistors. • No high-power video stages.

### Easy circuit alignments

Built-in sweep generator, and crystal detectors, in each RF stage provide simple alignment of transmitter.

### "Block-built" for higher power

Transmitter design is coordinated with G-E high-power linear amplifiers • Power may be increased later without need for transmitter modification.

### Complete accessibility

Full-length doors front and rear • Compact space-saving vertical chassis.

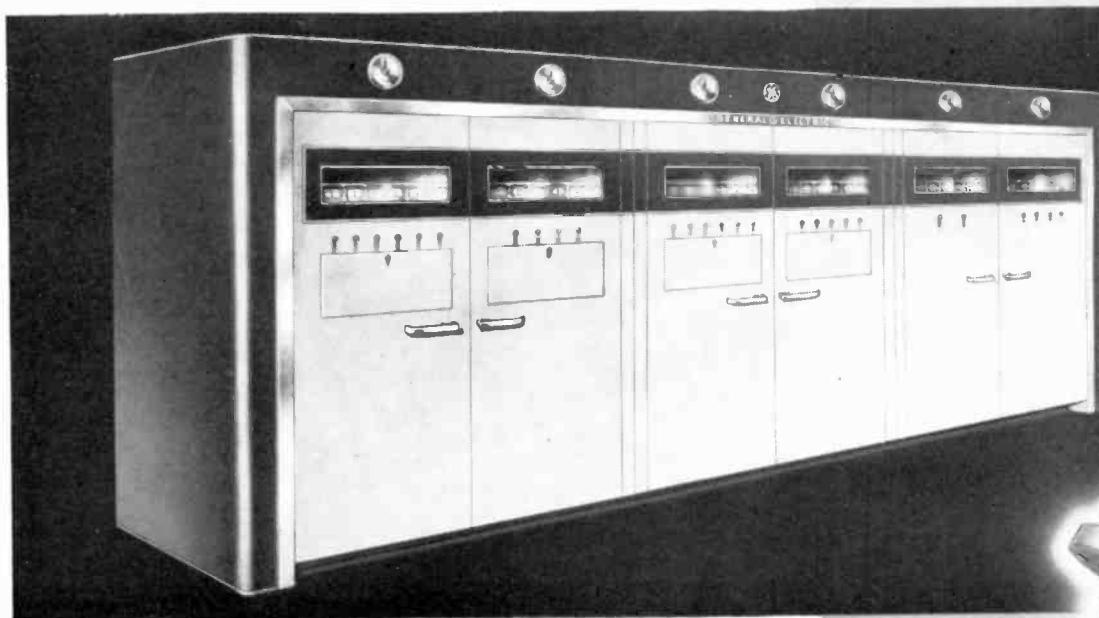

Type TT-6-A  
44-88 Mc

Type TT-6-B  
174-216 Mc



### Write for these G-E Television Books

*G-E Television Equipment Data Book*—An illustrated description of G-E studio units, transmitters, and antennas. Will be sent free when requested on your company letterhead.

*Television Show Business*—246 richly illustrated pages of television "know-how" by Judy Dupuy. An indispensable guide to better television program operation. \$2.50 per copy.



### Outstanding v-h-f

#### Power Amplifier Triode GL-9C24

Two sturdy GL-9C24 triodes—running lightly—deliver 5-kw of peak power in the push-pull power amplifier of the TT-6-A and TT-6-B transmitters. GL-9C24 features: compact design for close side-by-side mounting, ring-seal construction for low lead inductance, maximum terminal contact area, only two pairs of water connections per tube, minimum cooling requirements with low-pressure water supply, and ease of replacement.

**GENERAL ELECTRIC**

186-ES-0912

# c o n t e n t s

**FREDERICK A. KUGEL**  
*Editor and Publisher*

**MARY GANNON**  
*Managing Editor*

**SIDNEY R. LANE**  
*Associate Editor*

**DOROTHY HOLLOWAY**  
*Washington*

**T. R. KENNEDY, JR.**  
*Technical Editor*

**JACK KILPATRICK**  
*Patents*

**HELEN HOWLEY**  
*Research*

**PETER B. JAMES**  
*Business Manager*

**M. M. PRITCHARD**  
*Circulation Manager*

**RICHARD ROSE**  
*Art Director*

**COLOR ISSUE** 6

Despite reams of testimony, only basic issue of FCC hearings on UHF is expansion—by Frederick A. Kugel

**TIME AND WEATHER REPORTS** 8

Case histories show that a lot of selling can be packed into 20 and 50 second spots—by Sidney R. Lane

**STATUS OF INDUSTRY** 12

Complete list of operating stations, grants and applications—by Mary Gannon

**SETTING UP A FILM DEPARTMENT** 14

Blueprint for prospective stations to follow in planning their film departments—by James L. Caddigan

**IATSE VERSUS IBEW** 18

Tug of war between two rival unions is being carried into television—by Martin Schrader

**DEPARTMENTS**

**TELESCOPE** 2

Round-up of important industry news

**WASHINGTON** 4

WTVW-Evening Star demonstrates image orthicon equipment; FCC actions—by Dorothy Holloway

**ONE MAN'S REFLECTIONS** 20

Value of brains in television programming must not be underestimated—by Dr. Alfred N. Goldsmith

**ADVERTISING** 21

Analysis of current formats; list of current advertisers; WWDT rate card

**PROGRAMMING** 27

Field equipment successfully used in NBC studio show; programming schedule of all operating stations

**EQUIPMENT** 34

Cost comparisons of UHF and VHF equipment; diagrams of CBS' dual band receivers

**FILMS** 33

Television news coverage consistently beats newsreels

**EDITORIAL** 40

**PRODUCTION:** Transmitters and studio equipment are bright spots in the production picture. RCA has gone on record as being prepared to deliver 21 transmitters by June. DuMont, with one delivered to Detroit, is slated to have another six off the lines by mid '47. Once G-E gets rolling, they will materially add to these figures, but G-E seems to be beset with more production problems than almost any of the other companies. (For a resume of costs of station equipment, check "Equipment" on page 34.)

Receivers are coming along, but not very fast. RCA is still the only "volume" producer. Production figures given by Dr. Jolliffe at the color hearings in Washington, showed 15,000 to 20,000 receivers for '46; 25,000 due in the first quarter of '47, with a total of 160,000 by the end of '47. After that, facilities will be available to produce 300,000 sets a year. Farnsworth receivers now probably won't hit the market until March, with plans calling for 60,000 for 1947. DuMont's production will concentrate mainly on the high price line, with a new lower priced table model in the works. Philco and G-E should be out directly after the first of the year. Nothing more definite can be said of production plans at this time.

**ADVERTISING:** Activity seems to be concentrated among a few agencies. Young & Rubicam have four shows weekly—Bristol-Myers (Minit-Rub and Trushay), Borden's, and two for Gulf. Schedule jumped to five when three one-shots (drama, variety and participation shows) were added to Borden schedule on alternate weeks. J. Walter Thompson is also carrying a heavy load with Ford commercials on the "Parade of Sports" (WCBS-TV), in addition to Standard Brands' "Hour Glass" on Thursday and "Face to Face" on Sunday over WNBT.

At year's end, 31 advertisers were in television on a regular contract basis—many of them on more than one station. List includes:

Alexander Stores, Alexander Smith Carpet Company, Atlantic Refining Company, Automobile Manufacturers Association, Borden Company, Botany, Bristol-Myers, Bulova, Caples Company, Chevrolet, Commonwealth Edison Company, Cutter Cravats, Elgin, The Fair, Firestone Tire & Rubber Company, General Mills, Inc., Gillette Safety Razor Company, Gruen, Gulf Refining Company, Hirshon-Garfield Agency, Longines-Wittnauer, Henry C. Lytton & Sons, Marshall Field, New York Dress Institute, RCA Victor, Reid's Ice Cream, Sears-Roebuck, Standard Brands, Inc., Standard Oil of New Jersey, U. S. Rubber Company, Wanamaker's Department Store. (For details see "Advertising" page 21.)

Entire industry is waiting for full report on research of the Goodyear commercials used on the Army football games. Results will conclusively show television's tremendous effectiveness as advertising medium.

**WASHINGTON:** FCC decision on Paramount's interest in television applications means break-up of Paramount-DuMont set-up, or dropping 5

out of the 6 applications they now have pending between them. Ruling that Par's 50% interest in the Interstate Circuit in Dallas constituted a veto power, and that although Paramount had never used their voting rights in DuMont, they had never waived them, FCC considers that DuMont's WABD in New York and WTTG, Washington, with WBKB, Chicago, and recently granted Television Productions in Los Angeles adds up to 4 stations—with only one more to go. DuMont has applications pending in Cincinnati, Pittsburgh and Cleveland, with Paramount interests also represented by New England Theatres in Boston, United Detroit Theatres Corporation in Detroit, and Interstate Theatres in Dallas.

Solution will probably see re-arrangement of stock issue with Paramount gradually unloading their DuMont holdings (so as not to affect stock price). Each company could then press for the additional three stations for which they have applied.

With the Los Angeles grants, NBC obtains its fifth television okay and ABC its third. One and only's include Times-Mirror, Earle C. Anthony, Dorothy Thackrey. Grant to Television Productions means the second Paramount subsidiary to go commercial. Don Lee application was not acted upon, inference being that grant was withheld pending outcome of FCC investigation into network practices of AM radio operations.

**EQUIPMENT:** CBS' Peter Goldmark's announcement of a dual band receiver capable of receiving both black-and-white and color in the UHF and VHF attracted high engineering interest. Block diagrams of system are reproduced on page 37. Comparative costs of setting up stations under present VHF system as opposed to a color station on the UHF band, shows color running about 15% to 22% higher. (See "Equipment," page 34 for details.) Color fireworks will be resumed on January 27th in New York. (See "Color Issue," page 6.)

**PROGRAMMING:** NBC's use of image orthicon field equipment in radio studio 8G showed effectiveness of mobile units for picking up such shows as audience participation. Results should be encouraging to prospective stations for economy of operations in initial programming. (Story under "Programming," page 27.) Christmas formats showed full use of equipment and showmanship, with mobile units used to pick up toy departments, post office rush, carol services, plus studio presentations of Christmas stories and special children's programs. (Story under "Programming," page 30, good idea page for prospective stations to clip for reference next year when planning their "First Christmas" on the pix waves.)

**STATIONS:** At height of color controversy, Walter Damm's Milwaukee Journal application, withdrawn a few months ago to wait for color, was reinstated. Reasons given for change of mind were recent developments indicating that present black-and-white receivers will not be obsolete by move upstairs, network advancement in programming and increased production of



transmission facilities. High frequency experimentation is being continued.

With recent Los Angeles grants to ABC, NBC, Earle C. Anthony, Times-Mirror, Thackrey and Television Productions, plus a community channel awarded to Broadcasting Corporation of America in Riverside, California, there are now 46 grants, 9 operating stations and 19 applications pending. See "Status of Television," page 12.)

#### PERSONS AND PLACES

Bill Morris has changed over from the film department of J. Walter Thompson to a similar niche at BBD&O. His main activity will be to supervise use of film on television . . . Art Rivera, tele director of Donovan & Thomas, has been retained as television consultant by the Jean Fields Agency. Arrangement will not curtail his activity with Donovan & Thomas.

Gordon Colman associates, specialists in mobile television vehicles, has appointed J. Gordon Perlmutter as Senior Account Executive, and Norman L. Greenwald as public relations director . . . Well-known theatrical producer John Wildberg, who recently formed the John Wildberg Production Corp., has been appointed by DuMont in an advisory capacity . . . William H. Pfau exposition promoter has completed arrangements to feature a television demonstration which will be in cooperation with RCA-Victor and WBEN for his Buffalo, N. Y. show, scheduled for Feb. 22nd.

Good example of the educational use of tele was the BBC television program about atomic energy which featured a well-known scientist Dr. R. E. Allibone. With the use of charts and models he gave a dissertation of the atomic evolution and its innumerable uses in future peacetime applications.

#### BOOK REVIEW

Tom Hutchinson, veteran television producer, has written a book which is one of the most comprehensive analyses yet published of the many elements that go into television programming. Hutchinson describes the equipment end of programming as well as the actual television shows. His observations are based on unduplicated experience in television programming. The book, "Here Is Television," published by Hastings House is highly recommended for those who want a factual report on the problems and methods of television programming.

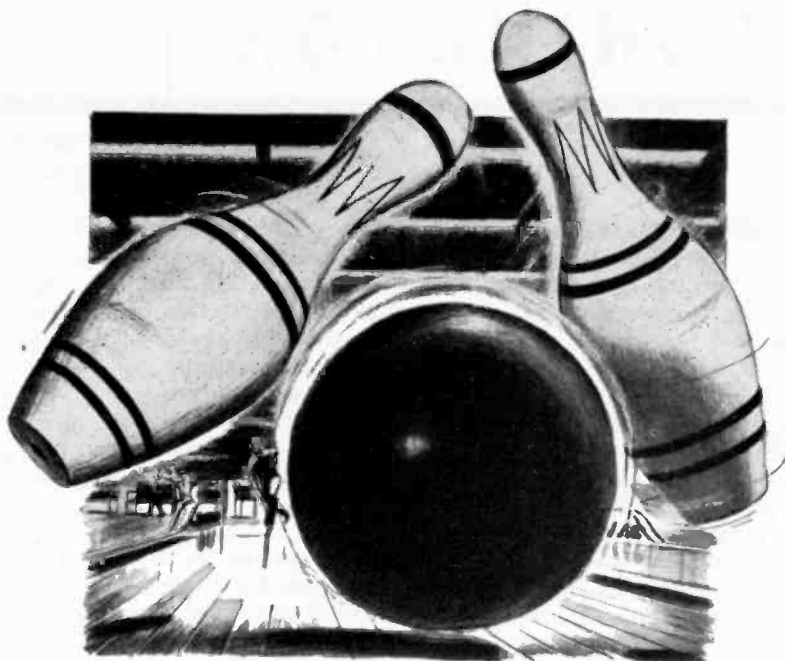

## CONTROL!

Only **MOTION PICTURES** give you **Control**

—**Showmanship Control** vital on

**TELEVISION** programs

- Only Film** can guarantee: perfect lighting—absolute focus—flawless dialogue.
- Only Film** can make possible: repeat performances of uniform quality—identical selling messages—selective marketing.
- Only Film** eliminates: costly rehearsals—telephone line charges—time zone differentials.

Now available for sponsorship . . . exclusive \*

Series. In 13, 26 or 52 week installments.

Write for details and arrange for private screening.

Send for booklet:

"Film—The Backbone of Television Programming."

# RKO TELEVISION CORPORATION



Dept. TN-5, 1270 Avenue of the Americas, N. Y. 20, N. Y.

A Radio-Keith-Orpheum Corporation Subsidiary

In Television . . . Film removes the question mark!

\*Copyright U. S. Pat. Off.

# WASHINGTON

**F**IRST prize for showmanship in promoting television in the nation's capital this month goes to the Evening Star station, WMAL. By resorting to heaven-knows-what means of persuasion the station received the first RCA image orthicon tubes delivered in the Washington area. This, in itself was something of a coup, since NBC-owned WRC has had an order on file for months and was understandably miffed to find itself playing second fiddle to WMAL. (RCA apparently goes on the theory it is better to take care of friends before relatives.)

Anyway, the image orthicons were no sooner out of the packing cases, then WMAL's enterprising publicist Tom Dolan hired a special showroom for them at Washington's fashionable Statler Hotel and WMAL engineers and producers swung into action.

First off, Dolan arranged a special press-radio preview of the new equipment. For the rest of an entire week, the orthicons were on parade for the public—but, and this did not lessen interest in them, "by invitation only."

Irony of the situation is that WMAL makes no bones about the fact its television station WTVW is still in the "dreamboat" stage. WMAL has neither tower nor transmitter and even in its most enthusiastic publicity estimates it will not be on the air before next spring.

As a result of this stunt, however, there are few Washingtonians who are in the dark about the station's television plans. And by virtue of some excellent newspaper publicity, most of them know why "image orthicons" make for better tv pictures.

## In and Out of Television

Los Angeles' grants gave official green light to NBC, ABC, Times Mirror, Television Productions, Earle C. Anthony and Thackrey. Application of Don Lee is being held pending FCC investigation of chain broadcasting practices of AM operation. Earle C. Anthony, also up for FCC investigation because of the firing of six commentators, received their grant on a split deci-

**WTVW**—The Evening Star displayed their new image orthicon equipment at the Statler in Washington and resultant publicity impressed Washingtonians with the quality of tv pictures. Here chief engineer Dan Hunter is training his camera on Mrs. Nancy O'Grady who is displaying a new refrigerator.



**WTVW**—Evening Star demonstrates field equipment; six Los Angeles grants—by **Dorothy Holloway**

sion, with Commissioners Durr and Hyde voting to defer action pending decision on case.

The state of Ohio won its fifth and the city of Toledo its first television station last month when FCC awarded video channel No. 13 to Commander George Storer's Fort Industries Company. Fort, which is enthusiastic about black-and-white tv, will spend \$189,000 for its Toledo station.

Indicative of this interest the company has already named a full-fledged television director. He is John Koepf who also holds down the job of Washington representative.

Fort has already participated with the help of DuMont Laboratories, Inc. in a tv demonstration in Miami. Koepf went to Florida with "jeep" television equipment to headline the anniversary celebration put on by Commander Storer's Miami station WGBS.

Also this month, the State of Washington picked up its first television grant. The Radio Sales Corporation of Seattle, licensee of KSRC, now has a lien on channel No. 5. Palmer Leberman, president of the company, has announced he will spend \$173,900 for his station.

Three other bidders, however, backed out of television before FCC could get around to granting their applications.

It came as no surprise when the Connecticut Television Co. of Booth Hill, Conn. and the Institutum Divi Thomae Foundation of Cincinnati, O. withdrew their applications. Neither had filed any information requested by FCC. The latter company, a church group in Cincinnati, had proposed to mortgage all its real estate properties in order to finance a television station. Mary Pickford, America's Sweetheart of the '20's, was to have been consultant on programming for the church station.

More surprising was the decision of Ted and Dorothy Thackrey, publishers of the New York Post, to withdraw their applications for New York and San Francisco stations.

The Thackreys, who have also pulled out a total of three FM applications, indicated that they had more immediate need for capital earlier earmarked for radio.

## Just for the Record

Almost forgotten in the press of FCC hearings on CBS color tv is an oral argument on a Commission allocation of frequencies for remote pickups and ST links now set for Jan. 15. The fight here appears to boil down to whether A.T.&T. will be a common carrier for such services or whether television licensees themselves will undertake the job.

## French-British Move Ahead In TV

French television experts were in America this month to study our progress. They were impressed by what they saw on inspection tours through G-E, DuMont, RCA and CBS. Three scientists on the mission—Stephane Mallein, Yves J. Angel and Gerard J. Lehmann visited FCC, the National Association of Broadcasters and several manufacturers.



*Television camera, receiving tube, all-electronic receiver and radio relay equipment —are the result of pioneering and research at RCA Laboratories.*

## ***Behind every big stride in Television—RCA Laboratories!***

From the scene of action—to your own living room—these RCA developments based upon research at RCA Laboratories mean *television at its finest:*

**RCA Image Orthicon Camera** sees whatever the human eye sees, even in the light of a match! Sports events on cloudy days or in twilight do not fade because this super-sensitive camera eliminates the need for strong lighting.

**RCA Mirror-backed Kinescope**—searchlight brilliance for home television. All the lifelike realism and detail caught by the RCA Image Orthicon Camera is reproduced by this new receiving tube that loses none of the original brilliance.

**RCA Victor Television Receiver**—with the new RCA exclusive “Eye Witness” feature that “locks” the picture, keeps it bright, clear—as steady as a picture on the wall.

**RCA Radio Relay** equipment enables television stations to broadcast events taking place far from the studio, and eventually may link television networks. In television, as in radio, Victrola\* radio-phonographs, records, or tubes, if it bears the name RCA or RCA Victor, it is one of the finest instruments of its kind science has achieved.

*Radio Corporation of America, RCA Building, Radio City, New York 20 . . . Listen to The RCA Victor Show, Sundays, 2:00 P. M., Eastern Time, over NBC. \*Victrola™ T. M. Reg. U. S. Pat. Off.*



**RCA VICTOR** table model television receiver with the exclusive “Eye Witness Picture Synchronizer” that assures you *brighter, clearer, steadier* pictures. It is now available in some areas—see your local RCA Victor dealer.



**RADIO CORPORATION of AMERICA**

## COLOR ISSUE



By Frederick A. Kugel

**B**OILING down claims and counter-claims which have beclouded the main issues at stake, testimony presented at the UHF color hearings resolves itself into one pertinent factor which will affect the FCC decision.

And that is expansion.

FCC is little concerned with whether color is mechanical or electronic or with the appeal of color over monochrome. Basic issue is primarily to determine whether by setting color standards as CBS has requested, an official ceiling will be placed on future developments in the UHF band.

Battle lines showed CBS, backed by Zenith, Cowles, Westinghouse, Federal and Bendix who testified in favor of the sequential, mechanical disc standards. But widespread disagreement of the balance of the industry was typified in the report of Panel 6 of the RTPB who studied the sequential system (but not the simultaneous one). Motion for withholding action until further tests could be carried out was approved by 11 members (RCA, DuMont, Philco, Farnsworth, Crosley, Stromberg, North American Phillips, TBA, SMPE, NBC and Bell Telephone Laboratories); three votes were cast against further tests (CBS, Westinghouse, Zenith); with four not voting (General Electric, Dave Fink (McGraw-Hill), Hazeltine, Bendix).

Testimony, pro and con, revolved around the following points:

### Sequential vs Simultaneous

CBS system is based on sequential scanning, using a mechanical color disc. Picture obtained is 48 frames, 525 lines.

RCA proposed a simultaneous, electronic system, with 60 frame pictures for higher definition, brighter images and allegedly more reliable color pictures.

Controversy here centered around flicker characteristics, with CBS' Goldmark stating that contrast—not screen brightness—was the important factor in a color picture at 48 frames. Opponents claimed that as frame rate increased, flicker threshold brightness increased—and that acceptance of a 48 frame system would impose a ceiling on the maximum brightness of a television picture.

RTPB poll of industry members on this phase showed three votes for sequential system; two votes for simultaneous; 14 in favor of continuing experiments. On the 48 vs. 60 frames controversy, 13 favored 60 frames; 4 voted for 48; with three undecided if sequential system was adopted. If simultaneous is adopted, three were undecided; 15 voted for 60 frames, with no votes cast for 48 frames.

### Dual System

CBS announced development of dual-band receivers, capable of receiving black-and-white in both UHF and VHF frequencies, as well as color in the UHF band. Present-day black-and-white receivers could not be adjusted. CBS claims that incorporation of the dual band in manufacturing process would ultimately be less expensive and more satisfactory than adding a converter.

RCA reiterated that with the simultaneous system, a radio frequency converter could be installed in present-day sets, to receive black-and-white in the UHF range, thus eliminating obsolescence factor in present sets.

Illustration above:

Left: CBS president Frank Stanton (flanked by two stenographers) gives his testimony before the FCC commissioners. At right are Commissioners Durr, Walker and Denny, in usual order.



## Electronic vs Mechanical

Although two systems are championed by the opposing factions, that's not main issue. CBS' Goldmark disclosed that he was now working on a single electronic tube which could be incorporated into the present sequential system, replacing the color disc.

RCA's simultaneous system is based on using three cathode ray tubes to pick up the three colors, transmitting them at once i.e., "simultaneously." (CBS testified that they had experimented with this system and discarded it in 1940.)

DuMont showed FCC members an experimental model of a Trichroscope Tube. Development of this, if successful, would mean one tube instead of three as proposed by RCA in their simultaneous system and could be used with either the simultaneous or sequential system.

## Propagation Tests

CBS testified to 1700 hours of field testing. Opponents detailed need for further field testing, suggested installing receivers in homes in various areas and testing over a six to nine month period under all conditions.

Point seemed of little weight to FCC Commissioner Jett, who stated that he believes propagation tests were sufficient if all other factors are worked out.

## Economics

Dollarwise, color equipment runs from 15% to 22% higher than present black-and-white (detailed cost figures under "Equipment," page 34). Receivers are estimated at 10 to 30% more—a fact which CBS says will be offset by the appeal of color both to the home viewer and to the advertiser.

## Time Table

CBS, if application is approved, plans to inaugurate partial color television service in New York "almost immediately." President Frank Stanton predicted that color television could be brought to the public within a year.

On deliveries of UHF transmitter and studio equipment, Westinghouse plans to go into production first on slide and film studio equipment and transmitters, following with live pick-up equipment. Time estimated for delivery is 18 months. However, Westinghouse also pointed out that because of the limited power that could be generated in the 480 to 920 frequency band with present tubes, their laboratories were now working on a tube to generate power levels of at least five kilowatts over the entire band. The laboratories have progressed to a point where they have their first full scale model sealed off in test now.

Federal, who made the original CBS transmitter now in use, has another one completed, and could take

orders for 5 to 7 with deliveries starting in the fall.

On receivers, Zenith testified that they had completed about a dozen sets and Bendix Aviation stated that they had an order for 50 receivers from CBS.

Production figures were shown by RCA—15 to 20,000 receivers in 1946; 160,000 in 1947; 300,000 in 1948; with other companies detailing their production plans and prices of present standard receivers.

## January 27th Hearings

After a full week of testimony in Washington, FCC members toured the DuMont plant and were shown the experimental work being done on all phases of color and monochrome television, as well as the assembly lines for receiver production. Following this, CBS gave another demonstration of its color system—held this time at a Westchester inn rather than the CBS laboratories.

Surprise twist to the hearings came with FCC's announcement that the color television hearings would be resumed in a federal court room in New York, the week of January 27th. At that time, CBS is requested "to repeat for the record actual demonstrations of its color television system, similar to those which have been made to the Commission and other interested persons."

All parties involved in the hearings have been requested to be present and will be given the opportunity to cross-examine CBS execs on every phase of the demonstration. Invitation to demonstrate their own developments has also been extended to the opponents of rainbow video now. After New York session, hearings will be resumed in Washington to permit further cross-examination of both factions.

Originally Chairman Denny made it clear that the demonstrations of both CBS and RCA, which the commission had previously seen, would not be officially part of the record, although he admitted they were bound to have some bearing in influencing the final decision. Sudden change-over, coming on the heels of the commission's visit to DuMont and CBS, has given rise to much speculation.

## Summing It Up

**PROponents:** Commercialize color television in the UHF band now. Give the public and the broadcaster an opportunity to choose between color and present monochrome systems.

**OPponents:** Withhold adoption of standards until further development of the various methods of color transmission (now underway) and further field tests in the UHF band are completed.

**FCC'S PROBLEM:** To decide whether setting standards for color television now will or will not impede further advancement and development of the television art.

Three key FCC staffers in the color hearings are, left to right: Curtis Plummer, chief of the television engineering division; Harry Plotkin, assistant general counsel who is conducting the hearings; George P. Adair, chief engineer of the FCC.



# TIME AND WEATHER

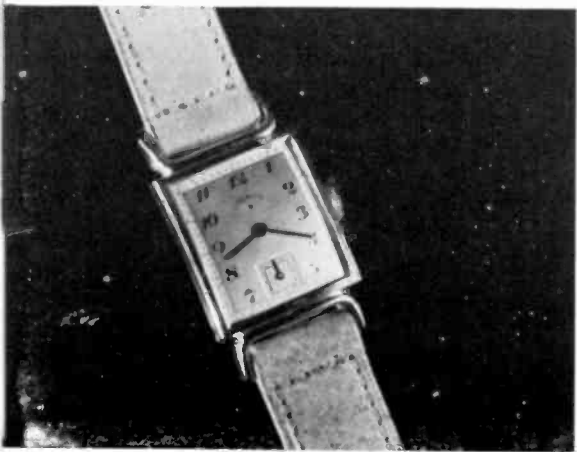
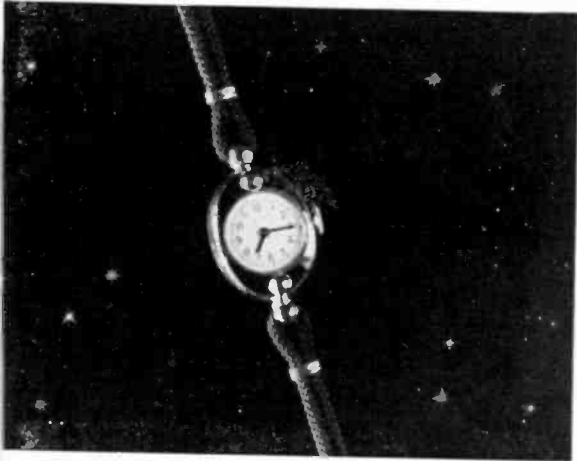

**N**O LONGER does a disembodied voice say "the correct time is—" or "tomorrow's weather will be—by courtesy of—" Television has added the sponsor's visual trademark and product to what hitherto resembled a somewhat hurried telephoned telegram. But it has also created new problems for the advertiser. How to get the time and weather information across and at the same time create an interest in the product without alienating the viewer is a problem that has engaged the following watch manufacturers: Bulova, Elgin, Waltham, Gruen, Longines-Wittnauer, and General Electric (clocks). The weather prediction has thus far been the television prediction of Botany Woolen Mills and Reid's Ice Cream.

## SCHEDULES

### BULOVA

Bulova sponsors time spots on two New York stations, WNBT and WCBS-TV. Through the baseball season they have sponsored the time signal which was given at the beginning, middle and end of ball-games over WNBT. In addition to this their contract with the station calls for Monday, Thursday, and Saturday 20-second spots. The schedule for WCBS-TV calls for two spots on Saturday, opening and after first program break, and opening signal on Thursday and Sunday.

### Format

Originally the Biow Agency (Bulova ad agency) utilized posters with the name Bulova on them. One poster was watch-shaped with the hands set at the correct time while a second hand swept around for sixty seconds during which time the only sound was background music. Later commercials have been more interesting, having been made by the Well-Got Trailer Service on film which features church bells with the name Bulova spelled out letter by letter and superimposed with each peal of the swinging bells. An off-screen announcer gives the correct time.

The latest commercial which Bulova is using for television is integrated with the device of the Bulova Goddess of Time. These commercials are on cards, but as station coverage is extended they will be translated to film.

The first card carries a graphic representation of the Goddess of Time who is placed over the phrase "America runs on BULOVA time." The second carries a close-up of the latest model. The third gives the correct time and carries out the theme that "America runs on Bulova time" by having a blow-up of an outline map of the U. S. with a watch face painted across it with the name "Bulova" again prominently displayed.

Here is a time spot which carried the Christmas gift value of the watch:

### Script

- 1—Goddess of Time (picture)  
"Meet the Bulova Goddess of Time"—world-wide symbol of fine watchmaking."
- 2—(A) Watch (picture)  
(A) "See this handsome Bulova Excellency watch—21 jewels—at better jewelers everywhere."  
(B) Santa Claus (picture)  
(B) "Yes—there is no finer gift than a watch—and no finer watch than a Bulova. Bulova—gift of a lifetime!"
- 3—Clock (picture)  
"It is exactly ..... P.M. B-U-L-O-V-A Bulova watch time. America runs on Bulova time."

Bulova well realizes the value of television time spots having learned with its very successful use of radio. Its radiotime spot bill runs into millions annually, and they have no intention of letting valuable television time spots get lost to competition.

### ELGIN

Elgin has contracted for time spots on five stations through its agency J. Walter Thompson. Tuesday they are on WABD at 8:30 P. M. On Sunday they have sponsored the time signals at the begin-

Top two: The twin themes of Elgin advertising are distinctly conveyed over television with Lord and Lady Elgin featured against a background of stars. Bottom: Association of style and accuracy for people who go places was emphasized in the Waltham filmed commercials.

# SIGNALS

BY SIDNEY R. LANE

ning, middle and end of all professional football games in addition to the 8 P. M. and final live spot that evening over WNBT. In addition to this they are on twice weekly over WCBS-TV, WBKB and WPTZ.

## Format

These are 20 second commercials on film which opens with shots of stars twinkling in the sky and ties in with the advertising theme that Elgin is timed to the stars. A Lady Elgin is shown coming through the starry sky to full screen proportions. This fades and is succeeded by a Lord Elgin watch which is in turn succeeded by a clock painted black with white sweep hands which is superimposed over the film giving the correct time. Commercial is handled with off-screen narration. An example of a short audio commercial for Elgin television time signal spot is:

**ANNOUNCER:** — (Quietly — Friendly) "America's traditional gift since 1865! The *Elgin Watch*, timed to the stars. See the Lady Elgin . . . the Lord Elgin . . . reasonably priced, exquisitely styled . . . the American product of four generations of Elgin master craftsmen.

"It is now (correct time) o'clock, Elgin Observatory Watch Time . . . *Timed to the stars!*"

WBKB Chicago have experimented with live time presentations. One of these one-minute commercials opened with a beautiful model who comments about watches in general and then calls attention to the one she is wearing. Narration off-scene continues the commercial, following with a close-up of the model giving the correct time.

Elgin is completing a series of new 20-second film animations which stress their standard advertising theme of accuracy, beauty and dependability.

## GRUEN

Gruen through its agency McCann-Erickson has a contract for two spots a week over WCBS-TV,

Thursday and Saturday at 9:15 P. M. They signed a one-year contract with the station which will run until next August.

## Format

Gruen uses a one-minute film which opens with a shot of Time Hill (the Gruen factory) and dissolves to a picture underscored with music and a shot of a Pan-American plane. Off-screen announcement proclaims "Gruen, the official watch of the Pan-American Air Lines." This is followed by a dissolve to a close-up of the watch mechanism, music fades down and studio announcer cuts in saying "Nine P.M. G-R-U-E-N (spelled out) precision watch time. See the new Gruen Curvex!" There are about ten variations of this final sentence which are changed periodically.

## LONGINES-WITNAUER

Longines-Wittnauer holds down the 9:30 P. M. spot Tuesday through Thursday on WABD. Agency is Arthur Rosenberg Company who has experimented with 30-second motion pictures and one-minute live spots. At one time they experimented with a 15-minute program called "Time Honored Ballads" which was produced mainly for the company's sales force, and featured a quartet singing for "the world's most honored watch."

## Format

Present format is quite simple being a one-minute presentation which is built around a blow-up of the face of the Longines-Wittnauer Watch which has an accurate clock behind it. As the studio camera focusses on this the following transcribed message is picked up:

"If you like cross-word puzzles, here is an eight letter word that means 'time' all over the world. The eight letters are L-O-N-G-I-N-E-S. Longines, which also stands for the world's most honored watch. Longines watches are made by one of the world's oldest fine watch factories, established in 1866. The honors which Longines watches

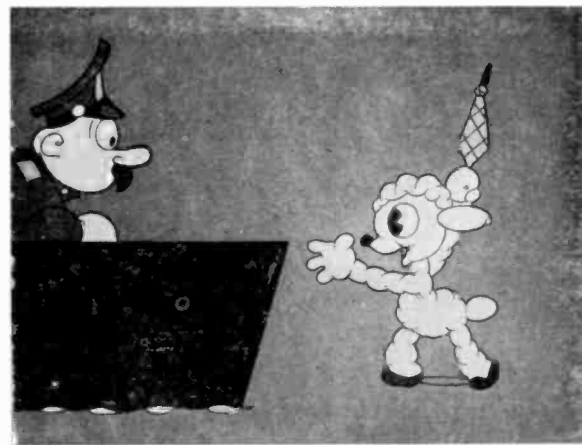
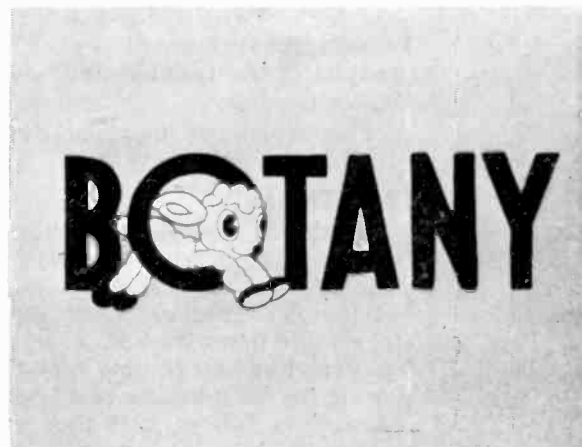

The Botany lamb threads his way through a series of seven adventures on cartoon films prepared by Douglas Leigh. Series have been giving weather (and neck tie) information since 1941.

have acquired were mostly won in international competitions, such as, ten World's Fair grand prizes, and 28 gold medal awards. Should you desire a fine watch, a good name to look for is 'L-O-N-G-I-N-E-S,' the world's most honored watch, a product of the Longines-Wittnauer Watch Company."

This is one of four variations which are used over WABD.

### WALTHAM

Waltham, though temporarily withdrawn from television sponsorship of time signals, did a noteworthy job. Through N. W. Ayer they nailed down the 9 P. M. signal on Friday, plus the time spot following the main boxing bout. From January to July of 1946 they also sponsored the Wednesday night time spots on WNBT's athletic events.

### Early Format

The first subject illustrated was a simple little story—boy waits for

girl—girl arrives late—her excuse—no watch. They look at watches in jewelry store window—they enter store and he buys her a watch.

A second commercial was made at the same time. The theme of this one was centered on the importance of time in the modern world. Shots of planes, air mail, and busy people checking their watches put the story across.

The film part of each commercial took 45 seconds and the remaining 15 seconds were used to show the actual time. Since it was impractical to televise direct full screen a Waltham watch three quarters of an inch high, a greatly enlarged photograph was used minus the hands. Then through a technique often used in film animation, actual scale models of the hands were set in place on the photograph and run from behind by clock movement. A fixed focus lens projected the image directly on the iconoscope tube in WNBT's film projec-

tion studio. This device was used for all the commercials. The watch design was changed by substituting photos of different models.

### Later Format

N. W. Ayer produced two films for the Waltham Watch time signals which tied in with woman's preoccupation with fashions. Theme of films, which were made by Caravel, carried out the association of elegance and Waltham. Conover models displayed fashionable attire against sophisticated backgrounds. One film was built around a travel scene in a railroad station, and the other took place in a box at the opera.

Waltham tried to produce spots on a very limited budget at first—but found that each succeeding picture demanded a greater budget if quality were to be achieved.

### GENERAL ELECTRIC

At General Electric's WRGB each night at 7:29:30, thirty seconds be-

Longines-Wittnauer in addition to regular one-minute spot over WABD put on a special fifteen-minute show which was tied in with a sales promotion program. Featured on the quarter hour performance was a quartet singing the time-honored ballads for "the world's most honored watch." Blow-up of the face of the watch is used for the regular spots.





fore programming begins, they telecast a short commercial on the time using the G-E electrical clock. This is a filmed commercial which demonstrates various models of the clock.

## WEATHER

At present three companies are sponsoring weather predictions, and they do a job which is far more intriguing than the Weather Bureau.

## BOTANY

The oldest sponsor of weather forecasts is Botany Mills through their agency Alfred J. Silberstein and Bert Goldsmith. Botany is probably the most consistent sponsor in television. Their present schedule calls for the weather report every Thursday at (9 P. M. over WABD) and Friday night between 8:00 and 10:00 P. M. over WNBT. They also sponsored the weather report over the latter station which preceded all Saturday football games.

Format consists of approximately seven variations of the Botany woolly lamb which is used to illustrate the weather in 20-second animated cartoons. These were prepared by Douglas Leigh.

The Botany series over WABD has been on the same film which was produced back in 1941 and features the antics of the cute lamb who threads his way through the letters of the word Botany as the weather prediction is given. The economy of filmed commercials is demonstrated by the length of time which these films have survived. It has been found that the average film is good for one year before new prints are needed. Main wear occurs on the sound track.

## GENERAL ELECTRIC

Weather spots are scheduled for Tuesday and Wednesday nights and are generally tied in with some G-E product that will alleviate the stress of weather—for example, electric fans when it is hot and electric blankets when cold weather is predicted. These are handled on slides and are accompanied by a musical fanfare.

## REID'S

Reid's Ice Cream sponsors a series of weather forecasts three times a week, Thursday, Saturday and Sunday at 8:30 P. M. over WCBS-TV through Doherty, Clif-



Reid's series of weather jingles can take care of sixty varieties of weather changes, which stress that ice cream will mix with any kind of weather.

Here's audio that accompanies these filmed cartoons:

1. "And say! . . . while you're out tomorrow, stop in at the store featuring Reid's Ice Cream



2. In a soda . . . your favorite sundae . . . or just plain . . . you'll find



3. Reid's truly delicious . . . creamy smooth . . . nourishing too. Just be sure you ask for Reid's Ice Cream . . . R-E-I-D apostrophe—S."

ford and Shenfield. These are a series of one-minute animated films accompanied by a library of sixty varieties of weather, each of which has a separate jingle. Here is a typical example of a Reid commercial. Following is for dismal weather:

Hand stamping Reid's seal in wax. (CUE)

"Now . . . the latest weather forecast . . . brought to you by Reid's Ice Cream . . . famous for quality since 1874.

(Insert appropriate weather jingle and cartoons)

Three children in a row flexing their over-sized arm muscles

(CUE)

"Yes, it's dismal weather, so be sure *your* young ones get the nourishing, body-building food they need . . . including Reid's Ice Cream.

Children lined up at table, bibs in place, licking lips and eyeing large plates of ice cream. "Mr. R" smiling in background

"Reid's provides all the health-giving elements of rich cream and wholesome milk products.

Children after having eaten

"And . . . it's *so* appetizing. Ask for . . . Reid's Ice Cream . . . R-E-I-D apostrophe—S.

Weather summary

"The temperature outside the studio now is—. Tomorrow's weather—.

(PAUSE)

Hand stamping Reid's seal in wax "And—don't forget *Reid's* . . . the name that has symbolized quality ice cream since eighteen seventy-four!"

## Charges

Charges for time and weather spots differ over various stations. WNBT charges are \$50.00 (split \$25 for transmitter and \$25 for facilities charge.) Time signals are sold only to watch companies but weather reports may be sponsored by any company desiring to do so.

WABD charges \$30 per spot for 2 minutes or less.

WCBS-TV charges \$30 for a station break of 20 seconds.

Reid's weather reports come to \$50 net for one minute.

## Summing It Up

Time and weather spots are good buys on television today. They offer the sponsor comparatively inexpensive time, uncomplicated production and a chance to sew up the best spots now.

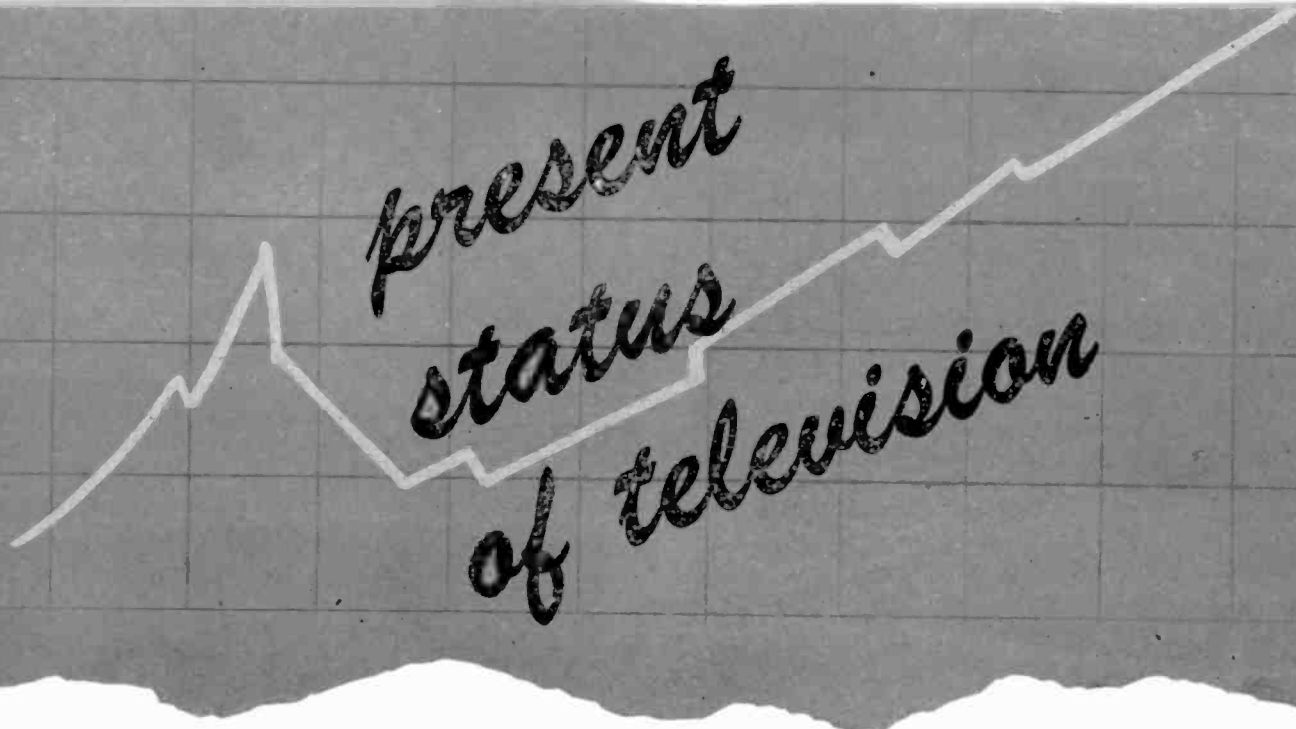

present  
status  
of television

By Mary Gannon

AT year's end, there were nine operating stations, 46 grants and 19 applications pending FCC action. First newcomer in '47 will be WWDT, Evening News, scheduled to open in Detroit this month, with KSD—Pulitzer Publishing Company pushing for a March opening in St. Louis. Both stations have already experimented with their mobile equipment on a limited programming scale. With transmitter production stepping up and construction controls easing, tempo of "opening nights" will steadily increase through 1947.

In Cleveland, Scripps Howard Radio has ordered equipment from DuMont for spring delivery and hopes to start tower and transmitter building very shortly. In Boston, Westinghouse announced purchase of a 10-acre site to house a new television-radio center, and down in Fort Worth, Texas, Carter Publications' television station KCPN will have a studio "large enough to drive a herd of cattle through."

Crosley Broadcasting, recently awarded grants in Cincinnati and Columbus, (with another pending in Dayton), started construction of their new \$170,000 TV and FM site in suburban Cincinnati. Antenna tower, 575' above ground level (1300' above sea level) will contain a turnstile antenna for television on the upper portion, with FM antenna on the lower portion. Transmitter and studio facilities will be located at the new site, with studios constructed with extremely high ceiling and like design for production of television programs. Cincinnati station will have call letters WLWT.

In analyzing the grants, NBC has received okays on all their applications, giving them the green light in Washington, Cleveland, Chicago and Los Angeles. These, plus operating station WNBT in New York, gives them the maximum of five. ABC has three okays—Los Angeles, Chicago and Detroit—with two pending in New York and San Francisco. CBS, if denied their FCC application to commercialize present color standards, will curtail their color experiments and go ahead with black-and-white. At present, only CBS foothold in the black-and-white field is their operating station WCBS-TV in New York.

Of the 140 market areas in which FCC have allocated television channels, only four—New York, Los Angeles, Washington, D. C. and Philadelphia—are either filled or have applications pending to use available pixwaves. This leaves such top ranking market centers as Chicago with two open tele spots (and possibly three if Zenith withdraws its grant for a black-and-white slot as testified to at the UHF hearing); Boston with two; Detroit with two; Pittsburgh with three; Cleveland with two; St. Louis with four; and San Francisco with two.

Population-wise, present applications will bring video to 1/3 of the nation's population, with 37 cities, 25 states and the District of Columbia represented by grants or applications.

FCC decisions are now awaited for New York, where with the recent withdrawal of Thackrey (WLIB, Inc.) there are five contenders for the four remaining channels. Betting has it that Debs will be left out in the cold, as they rated low in the financial scale. Reason for delay in issuing order is said to be caused by resignations of FCC men who had been working on the decisions.

### Operating television stations

City	Name of Company and Call Letters
Chicago, Ill.	Balaban & Katz Corporation—WBKB
Los Angeles, Cal.	Don Lee Broadcasting System— W6XAO Television Productions—W6XYZ
New York, N. Y.	Columbia Broadcasting System— WCBS-TV Allen B. DuMont Laboratories, Inc.— WABD National Broadcasting Company— WNBT
Philadelphia, Pa.	Philco Products, Inc.—WPTZ
Schenectady, N. Y.	General Electric Company—WRGB
Washington, D. C.	Allen B. DuMont Laboratories, Inc.— WTTG

City	Sales Rank	Population	Number of Channels	Applications Granted	Applications Pending
Albuquerque, N. M.		77,492		Albuquerque Broadcasting Co.— KOB	
Ames, Iowa				Iowa State College	
Baltimore, Md.	13	1,046,692	3	A. S. Abell & Co. Radio Television of Baltimore, Inc. WBAL—Hearst Radio	
Boston, Mass. (Waltham, Mass.)	5	2,350,514	5	Westinghouse Radio Stations, Inc. Raytheon Manufacturing Co.	New England Theatres, Inc.
Buffalo, N. Y.	14	857,719	4	WBEN, Inc.	
Chicago, Ill.	2	4,499,126	7	American Broadcasting Co., Inc. National Broadcasting Co. Zenith Radio Corp. WGN, Inc. (Chicago Tribune) WBKB—Operating	
Cincinnati, Ohio	16	789,309	4	The Crosley Corp.	Allen B. DuMont Laboratories, Inc.
Cleveland, Ohio	9	1,214,943	5	National Broadcasting Co. Scripps Howard Co.	Allen B. DuMont Laboratories, Inc.
Columbus, Ohio	29	365,796	4	The Crosley Corp.	
Dallas, Texas	27	376,548	3	KRLD Radio Corp.	Interstate Circuit, Inc.
Dayton, Ohio	44	271,513	2		The Crosley Corp.
Detroit, Mich.	6	2,295,867	5	The Evening News Association (WWJ) King-Trendle Broadcasting Corp. (ABC)	United Detroit Theatres Corp.
Fort Worth, Texas	51	207,677	3	Carter Publications, Inc.	
Indianapolis, Ind.	24	455,357	5	William H. Block Co.	
Johnstown, Pa.	100	151,781	1	WJAC	
Los Angeles, Cal.	3	2,904,596	7	W6XYZ—Operating	W6XAO—Operating
				American Broadcasting Co., Inc. Earle C. Anthony, Inc. National Broadcasting Co. Dorothy Thackrey The Times-Mirror Co.	
Louisville, Ky.	33	434,408	2	Courier Journal & Louisville Times	
Milwaukee, Wisc.	15	790,336	4		The Journal Company
Minneapolis, Minn. (St. Paul)	11	911,077	5	KSTP Minnesota Broadcasting Co.	
New Orleans, La.	31	540,030	5		Maison Blanche Co.
New York, N. Y. (N. E. New Jersey)	1	11,690,520	7	WABD—Operating WCBS-TV—Operating WNBT—Operating	American Broadcasting Co., Inc. Bamberger Broadcasting Co. Bremer Broadcasting Co. Debs Memorial Radio Fund, Inc. News Syndicate Co., Inc.
Philadelphia, Pa.	4	2,898,644	4	Philadelphia Inquirer William Penn Broadcasting Co. WPTZ—Operating	Philadelphia Daily News, Inc.
Pittsburgh, Pa.	8	1,994,060	4		Allen B. DuMont Laboratories, Inc.
Portland, Oregon	22	406,406	5	Oregonian Publishing Co.	
Providence, R. I.	18	711,500	1	Outlet Co.	
Richmond, Va.	48	245,674	4	Havens & Martin	
Riverside, Cal.				Broadcasting Corp. of America	
St. Louis, Mo.	10	1,367,977	5	Pulitzer Publishing Co.	
Schenectady (Albany-Troy)	23	431,575	5	WRGB—Operating	
Salt Lake City, Utah	58	204,488	5	Intermountain Broadcasting Co.	
San Francisco, Cal. (Oakland)	7	1,428,525	6	Chronicle Publishing Co. Associated Broadcasters, Inc.	American Broadcasting Co., Inc. Don Lee Broadcasting System
Seattle, Wash.	19	452,639	4	Radio Sales Corp.	
Stockton, Cal.	108	79,337	1		E. F. Pepper
Toledo, Ohio	34	341,663	1	Fort Industry Co.	
Washington, D. C.	12	907,816	4	Bamberger Broadcasting Service, Inc. The Evening Star Broadcasting Co. National Broadcasting Co. WTTG—Operating	

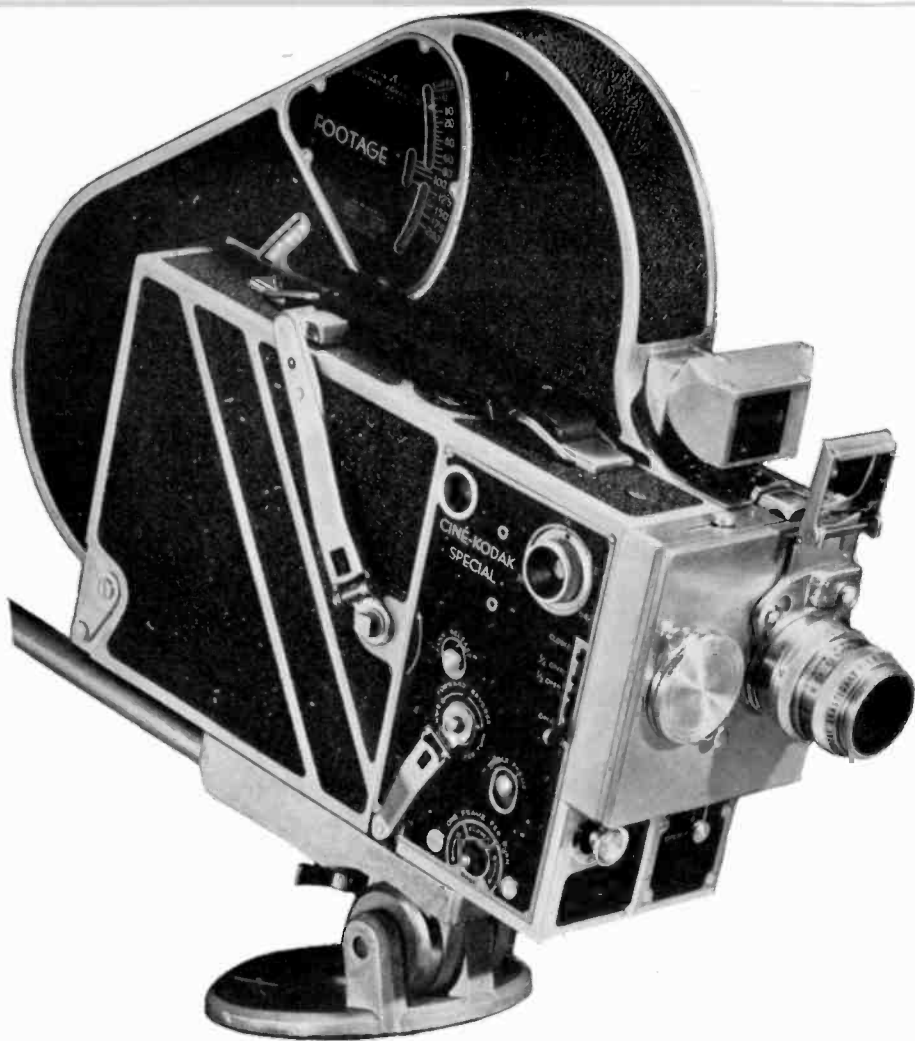

Cine Kodak Special—16 mm. with 200 ft. film chamber.

## Setting up a film

BY JAMES L. CADDIGAN

**M**ANY factors will control the amount of film production in which any individual local station may become involved. Inasmuch as sensible management would never condone the expenditure of thousands of dollars for equipment and personnel that might be used at very infrequent intervals, it is imperative that television film departments be custom tailored to fit the specific needs of a station. But the basic pattern of a film department will be fundamentally the same. It's my belief that the television film department will be a technical organization and that the talent responsible for scripts and direction will come from the station's regular production staff.

### Production Requirements

Professional advice and recommendations of an experienced camera and laboratory technical staff should be secured before equipment is ordered. Next the station should determine whether it will produce on 16mm., 35mm. or both. In network production centers, it may be an economic possibility to produce film using equipment manufactured

in both gauges, but in the local average video station it is almost a certainty that one gauge or the other will have to be selected for permanent use.

In all probability television film production will be classified under two major types. The special events (news) type of production which will require light, easily moved camera equipment with arrangements made for speedy processing; and the commercial type of film production which will be required to make the "Video-Transcriptions" for a station's local non-network accounts. Because of the involved production and editing techniques and the elaborate camera, sound, and lighting equipment demanded for the successful production of a commercial picture, it is recommended that, except in unusual cases, such productions be handled by an established commercial motion picture producer.

### Camera Section

In the blueprinting of a television film production department each section should be given careful consideration and the demands peculiar

to its functions be provided for. The camera section, apart from the usual office space and furnishings, should have available space in a ventilated, fireproof, safety approved film vault for the storage of raw stock and a convenient dark room, properly equipped with safe light fixtures and adequate working area, for the loading of camera magazines. Lockers or suitable closets should be provided for the safe, clean storage of cameras and their accessories. A spacious, tool equipped, work bench should be provided for camera maintenance and repair. Communications should provide twenty-four hour, self-operated service. Printed camera caption sheets should be designed and provisions should be made to keep an ample stock of such forms available at all times. The above are just a few indications of the special considerations and provisions that will have to be included in the plans for such a section.

### Camera Equipment

Basic camera equipment for special events coverage should include two silent automatic hand



cameras and one tripod. A versatile lens assortment, wide angle to telephoto, should be part of the basic equipment. Television will undoubtedly shoot the interview type of story "live" with a video camera. The technique of shooting special events with a silent film camera and later dubbing sound effect and commentary onto a projector synchronized disc, tape, or wire recorder should prove most practical. In the 35mm. class a camera of the type suggested, equipped with a single lens, will cost approximately \$330 plus tax, while the same camera equipped with a lens turret and several lenses will cost approximately \$1,400 plus tax. Tripod equipment suitable for service in this field will range in price from approximately \$170 to over \$950. Comparable camera and lens equipment in the 16mm. gauge would cost approximately \$220 to over \$300 plus tax.

If the type of production demands the greater professional versatility, the positive steadiness

and the extra footage made available by the larger magazines of the heavier tripod mounted professional camera, the station can expect to appropriate approximately \$3,800 plus tax for such a 35mm. camera and approximately \$2,900 for like 16mm. equipment. The approximate price of the 35mm. camera would include 3 lenses while the \$2,900 listed for the 16mm. camera would purchase the camera only. A suitable set of lenses for the 16mm. camera would cost approximately \$600. The above prices will give an approximate appreciation of the value of professional cinematographic equipment.

Special consideration should be given to camera equipment for coverage of sports events. The tripod selected should permit smooth, fast panning and tilting and should be equipped with devices to prevent slipping and being knocked over. The camera of course should be the tripod mounted, large magazine type, equipped with an electric motor which will give the necessary freedom needed to successfully follow whatever plays may develop during the game. As a basic unit, this type of camera should be equipped with a 12-volt battery powered motor and provisions should be maintained at the station for the necessary equipment to keep such batteries charged. If the appropriation is available, the same camera should be dual equipped with a 110-volt, 60 cycle A. C. motor

for use in locations where this type of current is available.

It is my definite opinion that nothing but professional equipment in perfect condition should be used in the production of motion pictures for video projection. Each succeeding step beyond the original subject in the photographic and mechanical reproduction introduces losses in quality that poor equipment should not be allowed to amplify. Video projection will demand as near perfect a television standard negative or positive that it is possible to project to the video-film pickup.

### Outside Contracts

Sound-on-film motion pictures present many production and processing problems that will undoubtedly limit this type of production to only the most ambitious of video film production departments. Equipment costs of camera and sound recording units alone run approximately \$8,360 for a 16mm. unit to approximately \$18,000 for a 35mm. unit. This will undoubtedly be responsible for the local television station contracting with some established producer for this type of presentation. In writing such a contract, special attention should be given to the demands and peculiarities of video-film projection and production. There is little doubt that the future will find such groups as the Television Committee of the Society of Motion Picture Engineers definitely setting nega-

department

Basic Layout—Film Production Department.

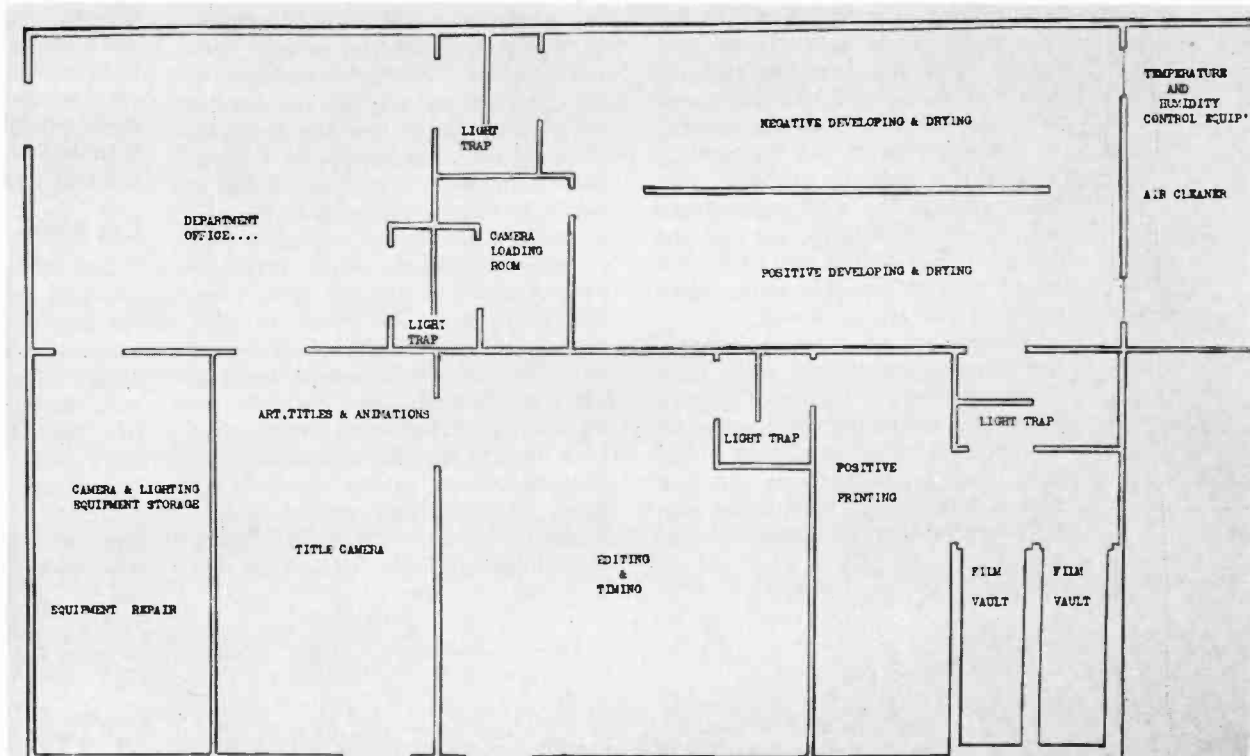

In writing this article, James L. Caddigan, manager of the film department, New England district, Paramount Pictures, has drawn on his twenty years experience in the motion picture industry.

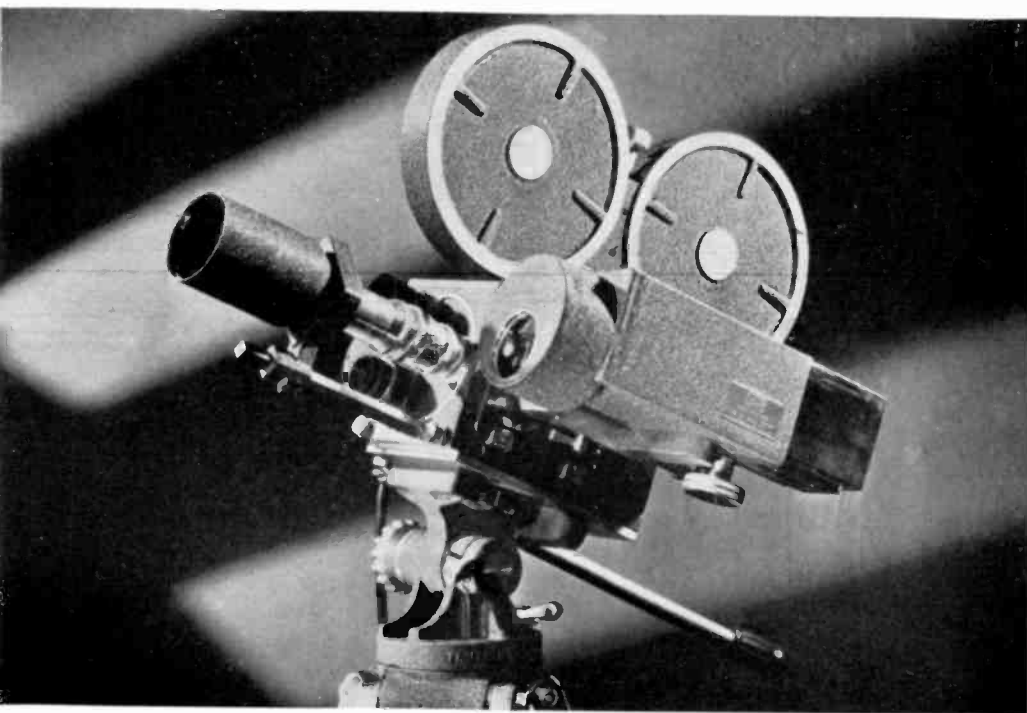

The new Maurer professional 16 mm. camera.

tive and print standards for video-film projection. When such standards have been decided upon, they should be embodied as "musts" in contracts signed by local stations for the outside production of film programs. Other considerations, peculiar to television, such as rehearsals, timing, advertised and scheduled telecasts, will demand that such things as a delivery deadline guarantee be included in the contract.

#### **Camera Personnel**

The basic camera section should have at least one professional motion picture cameraman on its full time staff. As a measure of protection definite arrangements should be made with two additional professionals who can be located for assignments at any moment of the night or day. In the local television station the staff cameraman will, in all probability, assume the duties of film editor and this fact should receive consideration when qualifications are reviewed.

Because of the unpredictable time occurrence of the news type of special event, a foolproof system should be instituted to insure an adequate supply of raw stock (negative and positive) and enough camera magazine to permit the constant availability of loaded magazines.

#### **Lighting Equipment**

Basic lighting equipment for a special events camera section should include 10 to 12 of the portable "Folding Music Stand" type of stands and reflectors heavy enough to take the "Movie-Flood" type of lamp. In addition a supporting frame should be designed, for both the 16mm. and 35mm. automatic hand camera, that will screw to the tripod hole in the camera base and will permit two light reflectors and photoflood lamps on either side of the lens of such a hand-held camera. This type of portable lighting equipment will not add greatly to the weight of the camera and will permit "roving" closeups to the limitations set by the length of wire available and the freedom of movement conditions at the incident. In many situations where it would be impossible to move in even portable stand lights, the hand-held camera equipped with attached photofloods will get the shot. Consideration must be given to adequate and serviceable lengths of wire for use with such lighting units. Such cables can be made up in between fifteen and twenty-five foot lengths and be equipped with lock-connectors to prevent loss of light due to lines pulled apart. Plugging boxes, correctly fused, should be available for use in sit-

uations where it is necessary to connect to the service mains in order to provide a line heavy enough to carry the light load. A licensed electrician will have to be available to handle installations on light jobs of this type.

The chief cameraman in charge of such a section should establish advance contact with firms who rent portable lighting equipment. Thus speedy procurement can be achieved should a sudden situation arise that required more lighting than the section had available. Rental price scales and transportation arrangements should be agreed upon beforehand. Though seldom used, a stock of photographic flares should be kept on hand for the one in a million story that could not be shot any other way at a location away from all power sources at night. It can be expected that the television station that enters into the production of commercial motion pictures will use their video studio and lighting for such productions and will plan accordingly.

The local television station may desire to rid itself entirely of the responsibility of operating a film production department and it is entirely possible to contract for the complete film coverage of special events as well as commercials with an outside motion picture producer. Extreme caution should be exercised in the placing of such a contract. A professional camera staff, ability to provide 24-hour service, the type and amount of camera equipment available for the station's continued use, possible contracts with other competing video stations, and reputation gained through past activity in the particular type of coverage the station may desire should be carefully considered. Aggressive competition of the scoop producing type will make it very necessary that at least the camera section be under the immediate supervision and control of the television station's management as a directly operated station activity.

#### **Lab Section**

The lab or processing department presents another section that leaves the way open for a wide variety of equipment and operational techniques. The station operated section will, however, be set up with one of two basic types of equipment. The hand processing technique will require tanks to hold the chemical solutions of the negative and positive developers; tanks or tank for the "wash," and tanks or tank for

the hypo "fixing bath." Racks, usually wooden, will have to be procured, upon which the undeveloped negative or positive will be racked. To complete the process, a drying "cabinet" will have to be devised in which either the heated air or processed film should be moving.

Tanks for this type of installation, holding one to six racks, would cost approximately \$75 to \$150 each and the associated racks, holding 200 ft. of 35mm. film would cost in the vicinity of \$5 apiece. Plumbing and filters necessary to supply water and drains for this type of processing would cost approximately \$500 for the average lab. The important drying cabinet, depending on the amount of film to be handled per hour, would cost from \$500 up to construct. The human equation in this type of film processing is of utmost importance, as the automatic controls of machine processing are not available and the individual judgment of the laboratory technician is responsible for the final quality of the processed print or negative. If a sta-

tion decides on this type of operation every effort should be made to procure the best negative technician and the best positive technician obtainable. When considering qualifications of applicants for the position of lab technician a background of *motion picture* laboratory experience should be a must.

Air conditioning, (temperature, humidity, and air cleaning control) is an important factor in the operation of the lab section and such facilities must be provided in order to insure against loss or damage of an irreplaceable negative.

The alternate technique would utilize the film processing machine that handles the complete processing chain under scientific methods of automatic control, from the time the exposed film is placed in the machine until it appears finished and reeled for projection. Machines are available that will handle 16mm. negative, positive and reversal film as well as the larger 35mm. equipment for negative and positive processing of the wider gauge stock. A 16mm. machine would cost ap-

proximately \$5,400 plus tax and the 35mm. machine would cost in the vicinity of \$14,000 plus tax.

Both types of processing will demand a laboratory section, planned and constructed to permit the maintenance of a high degree of constant cleanliness. Electrical circuits and switching devices in this area should be of the vapor proof, safety approved type and all white light and safelight fixtures should of course be vapor proof equipped. As a safeguard against the fogging of a negative or print, by the sudden flooding of light through an opened door during processing, all entrances and exits to such a section should be constructed with double entrances, plus the protection of light traps.

The possibility of using negative for video projection may simplify the laboratory set up for the station that is restricting its film production to special events. Improved negative emulsions capable of providing more normal gradations in the received positive video image are already beyond the experimental phase. The use of the negative for video projection will eliminate in the laboratory the entire positive processing chain as well as eliminating other sections of the department.

Bell & Howell, Eyemo 35 mm. camera, shown with spider turret, focusing alignment gauge, 400 ft. magazine.

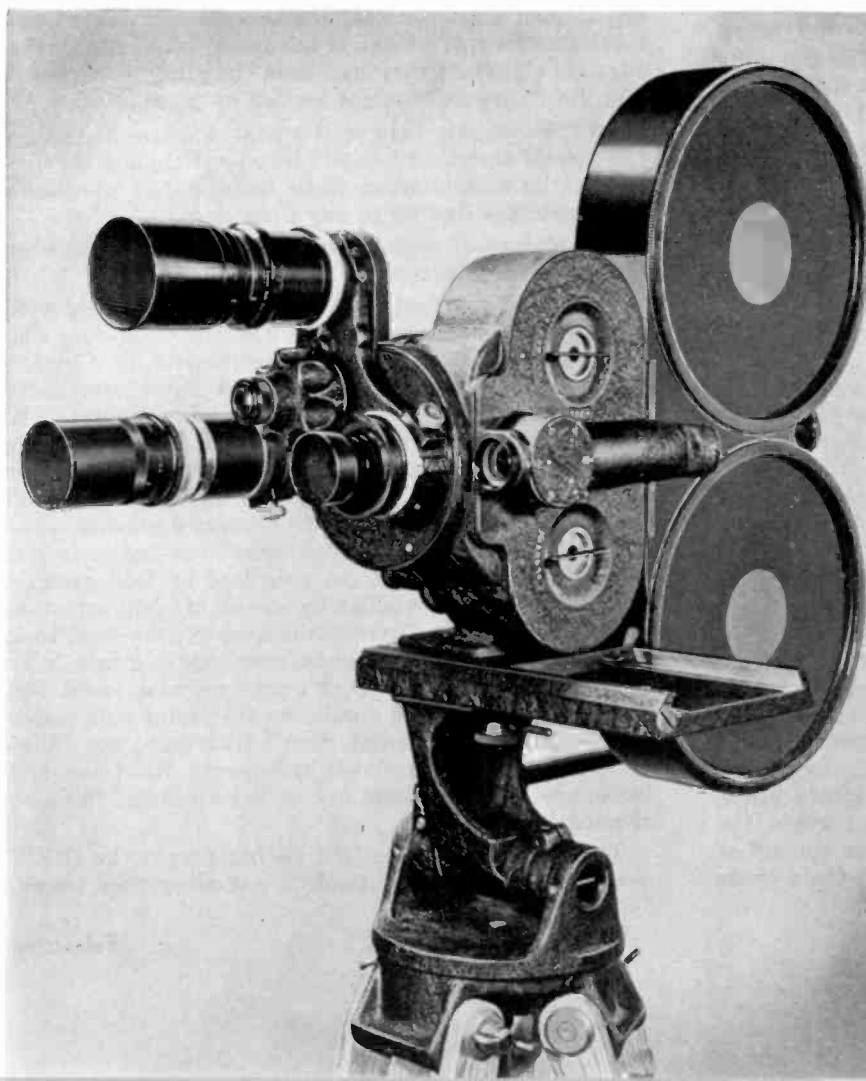

#### Local Labs

As in the case of the camera section, the station may contract with a local laboratory for film processing. If such a procedure is followed several very important conditions must be investigated before such a contract becomes binding. A contract laboratory must maintain high standards of cleanliness and provide a finished product which meets the eventual standards set for video film. Processed film must be delivered to the station projector as quickly as television standard processing will permit. Aggressive competition in special events will necessitate that a contract for outside processing guarantee 24 hour constant service on short notice and a top priority on laboratory personnel and facilities. Average processing charges, less the overtime factor of emergency situations, run from approximately 2 cents per foot for negative to approximately 5 cents per foot for positive after editing has been completed.

#### Film Editing Section

The television station, planning to handle the entire film production

(Continued on page 39)

# IATSE

VERSUS

# IBEW

## BY MARTIN SCHRADER

**T**HE sputtering fuse attached to television's potentially most explosive labor question—the matter of technical jurisdiction—is an old line trade union which goes by the resounding title of The International Alliance of Theatrical Stage Employees and Moving Picture Machine Operators of the United States and Canada, which, for obvious reasons, will be henceforth referred to as the IATSE or the IA. This is the union whose label must appear on every piece of film to come out of Hollywood, the union whose card and permit holders run nearly every theatrical 35mm. projector in North America, the union whose membership lists include every stagehand, theatrical electrician, scenic designer, grip and prop man in the legitimate theater. This is the union which is today making its bid for control of television.

### History of IATSE

Like any other trade union, the IATSE's growth and spread of jurisdiction is irrevocably tied to the growth and spread of the industry in which it operates. For better or for worse, the IATSE is wedded to showbusiness. As that industry grows new branches and develops mutations, the IATSE will follow it like water flooding a fresh gully. In 1893, when the IA was founded, it directed its appeal to backstage workers in legit and vaudeville houses, then the mainspring of showbusiness. It was designed in those days as a benevolent and protective organization whose primary function was to provide death and sick benefits for its members. But after it withdrew from the nearly expired Knights of Labor and joined the booming young American Federation of Labor, it became a moderately militant craft union. As the motion picture began to work its revolution in the entertainment world, the IA moved into Hollywood and, in 1914, won control of the thousands of projectionists who plied their trade

in nickelodeons and the back rooms of stores. Jurisdiction was granted the IA by decree of the 1914 convention of the AFL, after a long struggle with another AFL union, the International Brotherhood of Electrical Workers.

Hollywood streets ran red in 1926 and '27 as the IA and the IBEW slugged it out for jurisdiction over sound men and electrical workers in the newest and most startling of technical advances—the talking picture. The 1914 victory had been by edict of the AFL. The 1927 dispute was not settled as peacefully.

IATSE officials believe the next miracle to change the face of showbusiness will be television, and they intend to be around when those hundreds of thousands of technicians line up to pay their dues.

The history of some of the IATSE local has not been too beautiful a picture.

For instance, Local 110 in Chicago was blessed with a twenty-five year rule of one Thomas C. Maloy, who won jurisdiction over the projectionists in Chicago after he proved his gunmen could shoot straighter and faster than those employed by the local IBEW officialdom. Maloy was the inventor, as shown by the Dailey investigation in 1931, of one of the cutest tricks yet—flipping stench-bombs into theaters and then selling the managers \$.70 a quart deodorizers for \$22.50 a quart. Brother Maloy came to an untimely end in 1933, as a result of an overdose of lead from a sawed-off shot-gun wielded by one of his fellow motorists on Lake Shore Drive. Subsequently, the local took matters in its own hands and now enjoys a relatively clean reputation. New York's projectionist Local 306 went through a period similar to the Maloy rule under the direction of "Genial Sam" Kaufman, the "big-business man" of the labor movement. Kaufman and his immediate successors are no more and 306 has also cleaned house.

Throughout its career, the IA has fought the IBEW—and won. The IBEW itself is not altogether blame-



less (its Local 3, the New York electricians, was called by Harold Seidman in his book: *Labor Czars*, "the perfect example of all the ills inherent in an undemocratic labor organization") but its radio engineer locals are known as rank and file controlled, democratic groups, led in many cases by sincere men who have made a profession of labor organization.

The IBEW lost the projectionists in 1914. It lost the rest of Hollywood in 1927. It intends to hold onto television. Its strongest point in any legal battle is its constitution, approved by the AFL, which grants it control over "sight, sound and recording engineers in the broadcasting industry." And it contests the IATSE's claim to television film cameramen with the section which says: "(IBEW) . . . shall have jurisdiction over operators of picture machines where those machines are not used for theatrical purposes . . ." The phrase "theatrical purposes," according to an IATSE definition quoted by Charles A. Calame, business agent of 1212, the IBEW CBS local in New York, means films which are projected on a screen, in a place of assembly and for which admissions are charged. None of that means television, says Calame and adds that his local believes recording an event on film for later telecast is precisely the same process, in visual terms, as recording a program for later broadcast in radio.

For their part, IATSE business agents Sal Scappa and Walter Lang, recently involved in the UN dispute, protest that jurisdiction over all film cameramen, no matter by what industry employed, is explicitly granted them by their charters. They have further stated that the IA contemplates no wholesale raids on television, despite its actions in establishing a local at DuMont's WABD and in winning the election at Philco's WPTZ.

### IA Strategy

But these little skirmishes at the UN Security Council meetings, at the March of Dimes luncheon or at the Kentucky Derby are not the real thing. One of the major prongs of the slowly evolving IATSE strategy is the strange case of the CBS white collar workers.

A year ago, the CIO United Office and Professional Workers of America began to organize clerical help at CBS radio. Operating on the usual CIO industrial union policy, UPOWA officials included the television office staff, which works in a different building, with the radio people. That's when the fun started. The IA petitioned the National Labor Relations Board, declaring it was ready to set up a television white collar union and asking that the video department be considered a bargaining unit apart from radio. Back of this apparently innocent demand was the IA's desire to get a foothold among video office workers which would grow into a stranglehold on the technicians. The union felt it wouldn't have a chance with the already CIO-flavored CBS radio headquarters in on a bargaining agent vote and so asked that television be split from its big brother. This fancy piece of footwork gave the IBEW the screaming-meemies and the International was forced to hop in, claim it wanted to organize white collar people and hold out for radio and television as a single bargaining unit.

Thus we had the odd sight of a CIO and an AFL union in alliance against the demands of another AFL organization. And the situation was further complicated by the fact that the IBEW is not really interested in white collar members.

The IA lost that one after a bitter fight, but its tactics in the CBS case are a foreshadowing of the legalistic methods it will employ in television.

### NABET and ACA

There are two more unions in the television field which have made gestures in the direction of extending their organizations. One of them is the National Association of Broadcast Engineers and Technicians, an independent union growing out of an ex-NBC company organization. The other is the CIO's American Communications Association. NABET controls the technicians at NBC's New York station, WNBT, a job it inherited in its role as bargaining agent for NBC radio engineers. Labor observers believe NABET may get someplace in the NBC chain provided it doesn't have to buck the IA or the IBEW, both of which are preparing attacks on NABET which may be called any day. As an independent union, without the support of a strong International, NABET is considered a patsy for any group of tough unionists with money and backing.

The ACA is hard-bitten, aggressive, democratic. It has plenty of staying power, as evidenced by the thumping victory it won over Western Union last winter. But ACA is interested mainly in marine radio operators, communications employees and its impending merger with the CIO maritime unions. Its broadcast division is strong in Philadelphia radio stations, but in New York and other production centers it has taken a back seat. The big battle will be between the IA and the IBEW even though ACA has gone as far as to set up a television school for its membership.

### What's the Answer?

Is there a solution to this controversy? There is. Little help can be expected from Bill Green and all the vice-presidents on the moribund AFL executive board. Even if that body wanted to use its weight, it is doubtful that the IA would permit it. AFL rules say that the parent body can take a hand in jurisdictional matters only if both international unions ask its help. At the time of the UN fiasco, Patrick J. Healy, IBEW international representative, proposed just such a step. But the IA wouldn't play ball.

Outside agencies seem equally worthless. Again at the time of the UN situation, New York's Mayor O'Dwyer called a meeting at which his special labor representative, Edward F. McGrady, was to have mediated the question. IBEW officials showed up at the meeting, UN officials showed up, the press showed up—everybody showed up except the groom—Dick Walsh, president of the IATSE.

It would be utter foolishness for employers to stick their noses into an intra-union dispute, because they'd only wind up with a charge of unfair labor practices stuck on them—no light matter in an industry as sensitive to public opinion as television.

The responsibility for making intelligent decisions in these cases rests smack on the shoulders of the men who start unions in the first place; who can make them work or ruin them—the rank and file. The man behind the camera, on the mike boom or at the transmitter has to educate himself in trade unionism, learn how a union should be run, see if his union is doing it right and, if it isn't, clean house. It's up to the working stiff to take an interest in his union, its policies and its officers—and make sure that he is getting a square break. If he does that, he'll be able to speak up at a meeting without being sapped by some thug and employers won't have money wrung out of them by the same methods.

## Value of Brains

**D**URING the early stages of television, as in most new business ventures, the net profits to be anticipated are limited or absent. The television broadcaster is in the nature of a brave pioneer in a new field of vast importance to the public. It is a field which promises, with careful planning on his part, co-operation among members of the broadcasting group, and sympathetic and sensible regulations by the government, to offer the possibility of large and steadily increasing profits once the television audience is equipped with receivers and adequate program operations are established.

At first, however, there will of necessity be a building-up period in television during which large investments must be made, a steady drain on the available resources of the broadcaster must be anticipated, and both common sense, courage, and inspiration are required to carry on effectively and without errors in judgment which may ultimately prove costly.

More specifically, it is naturally to be expected that the television broadcaster during the early days of his operation, and while the television audience is being built up and commercial sponsors are relatively few, will adopt every possible measure of economy. It is true that economic operation during this period of the television experimentation is necessary. At the same time, it is also essential that sufficient expenditures shall be made along directions which will ultimately reflect favorably upon the reputation of the station, insure its acceptability to the public, and the advertising sponsor, and advance the television art in general.

### Station Personnel

Perhaps the most effective way of alienating the public and avoiding any chance of commercial success is to purchase the services of incompetently trained or mediocre men for use in the station's operation. It is a real drawback to hire a comparatively commonplace in-

dividual of limited experience, and to place him in a responsible and difficult position in a television station, agency, or advertising office. Such a man is, moreover, a most costly luxury. Far from being an economy, he represents a flow of money "down the rat hole," as the phrase goes. For every dollar saved on the salary of such a man, the broadcaster will later pay an amount far in excess of the apparent saving.

One is reminded of the old question: How many men, who are capable of jumping five feet individually, can succeed in combination in jumping ten feet? The answer is that no matter how many five-foot jumpers are available, even in combination they will never jump more than five feet. So it is in television. No matter how many mediocre or uninformed men may be available, they will in no combination solve the difficult problems of television operation.

Any student of present-day television developments knows that certain stations, some advertising agencies, and not a few prospective television commercial sponsors are employing men in television operations whom they will not think of using ultimately for an important job. Yet such men are given the supremely difficult task of devising television policies for the sponsor, selecting television media and program types on behalf of the agencies, or actually developing and putting on the air the television programs which reach the public. The results in such cases vary from dull and unattractive, to positively repellent. Fortunately some men of much superior ability are also active in television.

### Agency Personnel

Television organizations, whether they be the users of television, the agencies which advertise them, or the stations that send out the programs, are in grave danger of underestimating the value to them of brains properly applied in television. To select a proper program for a given sponsor involves imagi-

nation and the power of keen analysis. To select the appropriate station to handle such a program, the time the program is to be put on the air, and the general specification for its production are not tasks for a commonplace man in an advertising agency. The agency will need men equivalent to the best production men now on its staff to handle such problems. And the matters of writing appropriate scripts, selecting artists, choosing a sympathetic and competent director, hiring technical men of top ability to handle the studio equipment and television material—these are tasks calling for "topnotch" engineers and technicians. The best available man may perhaps not be a good enough one for any of these jobs, particularly in a new art where the public mood will be "Show me!"

### Expensive Economy

Such tasks, if properly carried out, require a competent television department for advertising agencies or stations and must not be entrusted to men having less than unusual intelligence. Excessive economy in the selection and payments of men in these various categories may lead to many and serious disasters.

The advertiser is gambling on the air with his reputation and standing. These may be greatly enhanced or seriously jeopardized by the men whom he selects to carry out so responsible a job as providing his television programs. Entirely similar comments apply to the station, the advertising agency, and the network with which the station is affiliated.

It should be understood that in television one does not have to hire a galaxy of super-men, but a practical compromise is possible and is earnestly recommended. What is needed in each case are at least one or two bright men, completely experienced in television or closely related fields. The employer should avoid like the plague hiring men who have failed, or are failing in other fields. Television is no waste-

(Continued on page 39)

# ADVERTISING

Analysis of current formats; WWDT rate card; NBC sets network charges; list of current advertisers.

## MARSHALL FIELD

### **Analysis of commercial techniques used in weekly half-hour variety show.**

The "Marshall Field Theatre" features Don McNeill in a variety format over WBKB. Integrated commercial is used, with usually one four minute-plug per show. However, when occasionally the format calls for more, two short commercials of about two minutes each are used. Merchandise is selected that ties in with the script, or when they want to plug one department or service, the show is built around those items.

From their experience, they have found that:

- Workable items have the most video interest—such as toys, cooking utensils, etc.
- Size, color and detail must be watched—very small objects do not televise well even in closeups.
- On color, whites and pastels, prints and large figures are good choices.
- Anything that is too shiny and reflects too much light is putted beforehand.
- For fashion shows, formal wear, especially the bouffant type dresses, are very good choices.

Price is given only when it has some special significance. In the camera show, for example, to show the contrast between the pocket size camera for the amateur photographer and the professional model with a turret lens, prices of \$29.50 and \$300 were quoted. When mention is made of the location of merchandise in the store, information is pretty general—such as, "You'll find these in our toy department," or "These gowns are from the 28 shop."

Typical examples of formats used were the Thanksgiving show and the toy shows. Frozen foods were a natural for the Thanksgiving show, with Don McNeill and his cast searching for a turkey plus all the trimmings for Thanksgiving dinner and having a tough time finding them. A cut back to

a model showing various packages of frozen foods was used, pointing up that the food was not only easily available but was also already prepared, needing only heating in the oven before serving. In this show, two short commercials were used because time was needed for the cast to change costumes and appear in a different set.

In the Toy show, story was woven around Santa Claus and his toy factory. When the factory was demolished by an explosion, a

gnome appeared on the scene with a large box of toys—from Marshall Field & Company, of course. He showed them to Santa, described each one briefly, and pointed out that thousands of children would not be disappointed if Santa would go to Field's for his toys. Mechanical gadgets were chosen—such as a washing machine that really worked, a gun that shot airplanes, etc.—so that the gnome could actually demonstrate them.

Marshall Field has found that evening clothes, particularly the bouffant fashions, are particularly telegenic. Here emcee Don McNeill poses with a quartet of chic models. Program is a regular weekly half hour show over WBKB.



## THE FAIR

### **Special Christmas shopping program added to weekly news segment.**

The Fair, Chicago department store, added a "Christmas Shopping Service" for the five weeks preceding Christmas to its regular weekly "Tele-Chats" newscast over WBKB. Igloo labeled "The Fair Christmas Annex" set the stage, with Pat Murray, the television shopper, sitting on an ice cube (imitation, of course!) at the entrance. Each week viewers were shown the gifts which Miss Murray selected, and were given an invitation to call or write her at the Fair if they wanted her to do their shopping for them. Audience bait was provided by asking the viewers to write in their gift problem, including an idea of what they'd like for Christmas and why. Gift awards of \$25 were presented to the winners on the last show. Tie-in between the "Tele-Chat's" news program and shopping segment was provided by having newscaster Bill Hamilton interview Santa Claus via radio just before Santa left the North Pole in a jet-propelled plane (give us back the reindeers, please!) for the Fair. Camera picked up Santa outside his igloo as he talked with Hamilton.

## BORDEN

### **Audience participation show first of three formats slated to test commercial techniques, in addition to regularly scheduled "I Love to Eat" spot.**

"Let's Celebrate" was the first in their three experimental formats to determine various methods of presenting commercials. (This is in addition to their regular weekly segment, "I Love to Eat," featuring James Beard.) Presented over WNBT, show was an audience participation format, with 250 vociferous guests "celebrating." Audience was furnished with hats, masks of Elsie, the Borden cow, horns and the resultant noise they made was terrific. With image orthicon field equipment used for



Christmas shopping format was added to the Fair's regular schedule over WBKB for the five weeks preceding Christmas. As come-on prize was offered to the viewers writing the best letters to Pat Murray, the Fair's shopper. Here Miss Murray displays the gifts she has selected to an interested spectator.

the first time in an NBC studio, (see story, page 27), two cameras were stationed at the rear and one in front to pick up the crowd reaction.

Stunts included a husband stuffed with balloons and his wife equipped with nail point boxing gloves in order to deflate him.—prize being an overcoat. Idea was to pound him down to size and get him into an overcoat before the time ran out. New twist to necking was given by having two young couples try to transfer a box of Borden's None-Such Mince-meat tucked under the men's chins to the girls' chins. Phone call was made to a bedridden youngster, asking him to remove the sheet from the package near his bed, prize being a television set. Good way of working in a variety segment was provided by telling the youngster to watch the next act, which would be typical of the entertainment that would come to him over his television screen.

But piece de resistance of the entire show was Elsie, in person. After fanfare announcement of a famous star celebrating her tenth anniversary, curtain was parted to show the in-the-flesh version of the famous Borden trademark. Stunt was worked around Elsie by leading a blindfolded young man onto the stage, giving him a build-

up about the date they were arranging for him, seating him in front of Elsie—and having a glamorous girl act as her voice.

Commercial was handled mainly by reiteration of the name Borden, with the presentation of the prizes, and of course, with Elsie. Only product to get a direct plug was None-Such Mince-meat. Agency is Young & Rubicam.

Borden's "I Love To Eat" over WNBT opens with a sketch of Elsie, famed Borden cow. Then James Beard takes over and demonstrates some of his unique dishes in front of the television camera. Every step in the basting, and trimming, and cutting is picked up by the television camera.

Commercial was handled by the device of a fortune-teller and her crystal ball. Stirring music underscored this part of the program as James Beard walks in to consult the fortune-teller who says, "I see in my crystal ball the letters LC," which of course immediately translates to "Elsie." And then with superimposition and cross dissolves, Hemo is plugged through the medium of the crystal ball. After this commercial, camera scans back to kitchen where Beard drinks a revitalizing glass of Hemo and finishes cooking the meal.



## BRISTOL-MYERS

### **Trushay and Minit-Rub program switches from film to live over WNBT.**

Bolstered by an additional appropriation, Bristol Myers' Trushay and Minit-Rub have switched from their film travelogue and cartoon film commercials to experimentation with both live commercials and formats. Products alternate each week over WNBT.

On the plug for Trushay, commercial was well done, with the groom carrying the bride over the threshold and the two waltzing around. Off-screen voice told her she was married now and her dancing days were over. So off came the veil and the bride tied an apron over her dress as she walked over to the sink and to the laundry tub at the announcer's bidding. Pantomime expressions of the girl were excellent and commentary amusing. As she was about to get to work, he cautioned her again about her rough red hands and an amusing piece of business was added by having her rub her hands together, with a sandpaper sound effect. A

bottle of Trushay came into the scene, complete with wings because it was heaven sent, and she followed his bidding in comic fashion, rubbing it on her hands, her face, rough elbows, her legs. As for "all over," she dived behind a screen, draping her "intimate things" over the top, finally popping up and saying her first words—"Hey, you're right!"

Minit-Rub commercial, titled "A Play," evolved around a young man all set to propose. But each time he was ready to pop the question, the girl sneezed until he finally asked her why she didn't get rid of that cold and slammed out. Same pantomime ideas as in Trushay was then used, with Minit-Rub floating into the scene and off-screen announcement telling her how to use it. Quick glance at the clock showed the minute elapsing, with next shot showing the girl sitting comfortably—with no more sneezes. Boy again made appearance, repeated the same formula, this time interrupted by his own sneezing and finally wound up asking her for her tube of Minit-Rub.

Variety formats were tried out so that Bristol-Myers could select one. First show, "Stage B," should

never have left the first try-out stage and proved that viewers should not be victims of experimentation. Show was uncoordinated, with no semblance of unity between the acts. Second show was quicker moving, with each act introduced by a title card. Agency is Young & Rubicam.

## GULF OIL

### **Schedule increased with "You Are An Artist" over WNBT added to sponsorship of the CBS news.**

Gulf's sponsorship of WNBT's package "You Are an Artist" stars Jon Gnagy with his lively commentary and quick pencil. Opener shows Gnagy drawing the word "Gulf" and circling it, followed by a prepared card stating that "The Gulf Oil Company and Your Gulf Dealer Presents" . . . Same closing is used with Gnagy again sketching "Gulf."

Capitalizing on the interest of people in rubber-necking at an artist at work, this program attempts to teach as well as satiate curiosity about the mystery of graphic manual representation.

Theme of program was Christmas and the artist with simple stroke and instructive chatter created a scene with all the accoutrements of the holiday. A tree was there, gifts were there, holly was there—but above all the artist's hand was there . . . and it was definitely in the way through most of his creative instruction. Most of the lines seem to emanate from all five fingers, since the camera was directly pointed at Gnagy's hand. For a program purporting to teach drawing, it is important that the viewer have a clear look at the lines as they are originated. Camera angling should solve the problem. His instruction is perhaps a little fast for the novice—but someone has to be sacrificed to keep the program sparking.

Gulf commercial on the CBS news, telecast weekly over WCBS-TV, uses a standard opening and closing which shows the Gulf gas station tank, with the word Gulf disappearing as quick flashes of news pictures appear in the circle. About the half-way mark in the fifteen minute presentation, cartoon type commercial is used, with

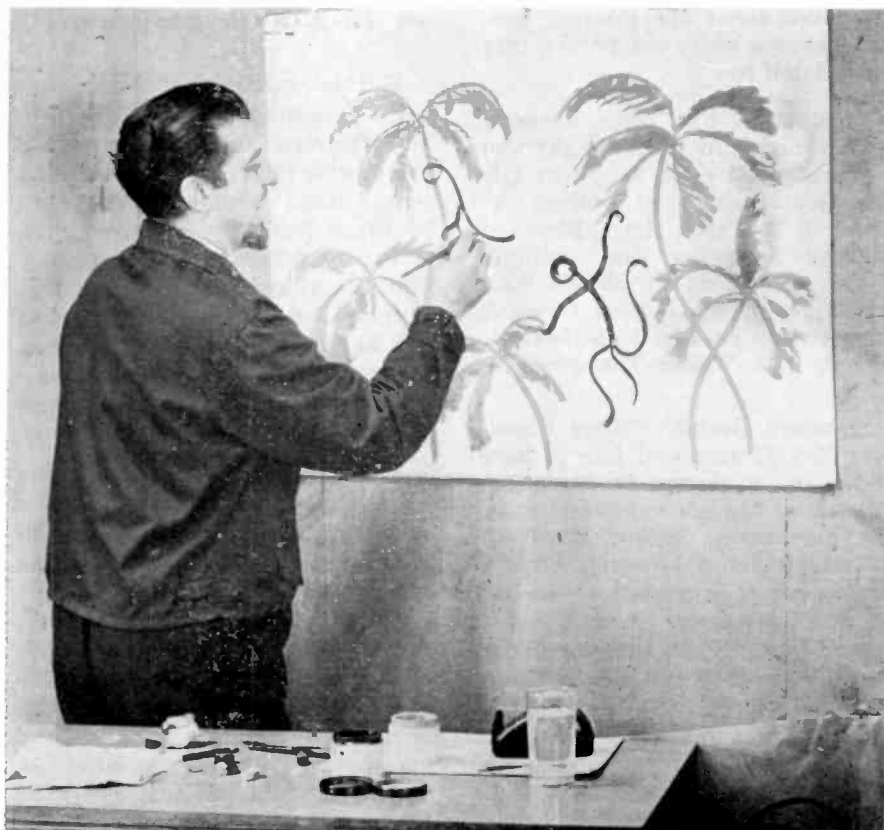

"Reluctant Roger," a very unhappy car playing the stellar role. Roger and a turtle shared honors for going up a hill until one day Roger stopped at a Gulf station, and it perked him up considerably. Animated sequence showed Roger rolling along with the scenery moving in the background. Concluding commercial also used a standard formula—boosting a Gulf station within touring radius of New York. Stills of the station were shown and video introduction made by showing a picture of the man who runs it.

News presentation is well handled. Newscaster Milo Boulton's commentary is visualized with maps, cartoons, stills and films. Labor and government issues in the recent coal strike, for example, were visualized with drawings, while the effects of the strike on transportation and the nation in general were depicted by excellent film sequences of coal loading, locomotives, etc. Superimposition of the titles over the film was also a good trick, for it gave news value to the pictures. Brief film scanning of Greece led to an interview with Mr. Antonescu who discussed the condition and problems of his country. Good sound tricks were employed, such as the telegrapher's key for news flashes. With the announcement that radio stations were not as yet subject to curtailment in schedule, films of the main CBS transmitter were shown, accompanied by recorded music and the sound of applause to signify the entertainment service which the station was giving. Show moved quickly and visualization of commercial was in keeping with format. Agency is Young & Rubicam.

## STANDARD BRANDS

**"Face to Face" varies format; "Hour Glass" features Eddie Mayehoff.**

Although holding to the same cartoon idea format, changes in the "Face to Face" show over WNBT result in greater variety. With Sugar, the femcee, introducing the two Dunns, stunts include Bill Dunn sketching by description a "victim" being interviewed by Eddie Dunn on the other side of a curtain. Camera veered from close-up of the girl to close-up of the

cartoonist's handiwork. Wind-up showed the girl standing next to the cartoon, with Bill finishing it up to tie in with her occupation. Presentation of Instant Chase & Sanborn is her reward for her appearance—plug the product plug, of course. (This idea, while basically the same, is an improvement over the old format where the "victims" were in the viewing room and the home audience were not picked up for the home viewers until the second part of the program when they went down to the studio.) Other stunts included a "Who am I?" cartoon, with a member of the viewing audience on the ninth floor being given clues to guess the identity of the person being drawn. Prize money drops as clues go on.

Commercial comes in at this point, and after following this program regularly, the conclusion is still the same—it is a radio commercial, too much talk, too much ham. With the bright remark that it's Chase & Sanborn time, the two Dunns joined Sugar at the coffee table while she prepared the coffee. Camera caught her hands in close-up as she measured out a spoonful of the instant coffee and added the hot water. But there's too much exuberant exclamations about the taste, its deliciousness, its easy preparation, etc.—and seeing a man with a cup of coffee in his hand while he gives a ream of adjectives about the product does not change a radio commercial into a television one.

Final stunt had Dunn drawing from a model. In this case she was a representative of the Post Office Department and obliged by giving a few well timed hints on package wrapping and mailing. Show opened as it closed with three jars of the Instant Chase & Sanborn for product identification. Agency is J. Walter Thompson.

Standard Brands' "Hour Glass" over WNBT seems of late to have undergone a change in execution. Burden of the show is carried by one personality, Eddie Mayehoff. In this instance however, with a man so adroit in comedy as the latter, the hour length show does not appear to suffer. In this particular program, setting and characterization stem from the deep south. Opening to establish locale with film clips of the old Kentucky home. Mayehoff's routine throughout burlesqued some of the South's better

known prototypes. At one point he was typical Mountain Dew white trash; at another point he was a Southern Colonel; at another an office seeking, rabble raising politician; and another a movie director directing the "Birth of a Nation Strikes Back" which was "so big they had to slit it in the middle and run it as a double feature."

Carrying out more of the theme were the Coleman Brothers who made with some fine cotton picking harmony; Nell O'Day was the sweet southern belle who carried on the burden of femcee temporarily vacated by Helen Parrish. Others on the program were Fountain's Acrobats, Patricia Bright, Amy Sedell, and the team of Flourney Miller and Moreland, and the dance team of Church and Hale.

Commercial plugged Instant Chase and Sanborn twice during the laugh-provoking program. Main emphasis was a graphic presentation of the speed of preparing coffee with the product without loss of genuine "shade grown flavor." This was emphatically, if rather lengthily projected.

## ALEXANDER SMITH

**Singing jingles and one direct commercial used on 15-minute program.**

Alexander Smith's "Magic Carpet," presented over WABD, uses an offscreen singing commercial jingle with the opening and closing slide. Direct commercial is given by Clara Dudley, company stylist, at end of fifteen minute program. Cameras picked up Miss Dudley in close-up and switched to swatch of rug as she described the pattern. Large geometric leaf design televised well but still of room to show rug placement was too indistinct.

Format of show is travel tours with voice over commentary. Show opened with shot of youngster answering the telephone and telling her mother that a visitor had left a Christmas present for her. As she waited for her mother, curiosity got the better of the little girl and she opened the package, bringing out a doll, a panda and finally the Lady of the Star. As youngster fell off to sleep, the Lady of the Star came to life and

dissolve was made from the star to her. Good production work was evidenced here with the same proportions being kept and a black background used around the live star. The doll and panda came to life then and took the little girl on the magic carpet to toyland. Dissolve effect of clouds was obtained by pouring milk into water and as it swirled upward, superimposing the youngsters on the carpet over it. Switch was then made to film—in this case being the Nutcracker Suite theme and the miniatures used in Macy's Christmas window. Offscreen narration by the "Star" detailed the story to the youngsters. Film was shot by Bud Gamble, who also produces and directs the bi-weekly show. Agency is Anderson, Davis & Platte.

### ATLANTIC REFINING CO.

#### **New trick devised to give visual appeal to quickie announcements at basketball games.**

Atlantic Refining Company is sponsoring the University of Pennsylvania basketball games over WPTZ. Because of limited audience, problem was to work out commercials as inexpensively as possible so cartoon comic strips were originated by Dick Rose. Comics are placed in a book, tabbed on bottom and the announcer at the field reads the copy and turns the pages. Three game sets have been made up, each set consisting of three dramatized stories of 8 to 12 drawings. Each commercial lasts about 1 to 1½ minutes.

There is no attempt at hard, straight sell, with the commercial on fuel oil told in story fashion. Because product is a home commodity, and to associate the commercial with Philadelphians, ideas behind strip is to present a typical Philadelphia family—named Phil A. Delphia. Typical example of story plot shows Phil reading a comic strip to youngsters, about Iggy Eskimo who's so cold that he's thinking of going south. Commercial point is worked in with final shot showing Iggy, the first Eskimo to install an oil furnace, stripped to trunks in his igloo.

Best trick of all though is the visualization of the quickie announcements. At time-outs, etc., they are using a series of Atlantic phone numbers or Atlantic furnace oil signs. These are picked up by one field camera and superimposed over field shots, such as a pick-up of the clock, the crowd, etc. One particularly successful use of the system showed a little service attendant carrying the Atlantic sign—camera panned in direction that he was walking, giving the impression that he was strutting across the clock. Method was worked out by Philco and tele director Don McClure. Agency is N. W. Ayer.

### GENERAL ELECTRIC

G-E electric blanket commercial was integrated with a "Shopping for Skis" format over WRGB. Built around a young girl browsing through a store and attracted by the ski display, dramatization included skiing instructions as to the type of skis she should use, how they should be fastened, etc. Fashion note was added by having the girl go over to the sports department and as she is looking through the rack, models parade by, sporting the latest in winter sports togs. Just one commercial was woven into the 15-minute story.

### SPIEDEL CO.

In their sponsorship of "Detect and Collect," Spiedel dramatized their Golden Knight watchbands and expansion bracelets. Designed on the principle of the "hinging" of old time armor, an armor-clad Knight was on hand to answer the quiz questions about the merchandise. Good close-up shots of the selling points of the expansion bracelets did an interesting job of putting the story over to the viewers. Included in the commercial sequence were shots of a wrist slowly turning to show the watch band, with a hand pulling it out to show its flexibility. Next shot was of a man putting his watch on a stack of towels while he washed, then taking a towel with the watch falling to the floor. Another shot showed washing with the watch on and getting it wet. Final selling punch showed the wise man pushing the watch far up on his arm, where it was safe from splashing, falling or absent mindedness. Offscreen announcement gave the description.

Format of "Detect and Collect" is audience participation, with the stunt concealed behind a screen and the contestant given three chances to guess. Prize money drops as clues mount. Program was bought by Hirshon-Garfield Advertising Agency in order to demonstrate to their clients the value of video advertising. Bobbie Henry directs the show which is telecast by ABC over WABD.

### WWDT Rate Card

	1	13	26	52	100	200	260
Time	Times	Times	Times	Times	Times	Times	Times
	5%	10%	12½%	15%	20%	25%	
	Disc.	Disc.	Disc.	Disc.	Disc.	Disc.	Disc.
1 hour.....	\$250.00	\$237.50	\$225.00	\$218.75	\$212.50	\$200.00	\$187.50
½ hour.....	150.00	142.50	135.00	131.25	127.50	120.00	112.50
20 minutes.....	125.00	118.75	112.50	109.37	106.25	100.00	93.75
15 minutes.....	100.00	95.00	90.00	87.50	85.00	80.00	75.00
10 minutes.....	75.00	71.25	67.50	65.62	63.75	60.00	56.25
5 minutes.....	50.00	47.50	45.00	43.75	42.50	40.00	37.50
*Announcements	25.00	23.75	22.50	21.87	21.25	20.00	18.75

\* 1 minute or less

The above rates are subject to 15% commission by recognized agencies.

No cash discounts.

Listed rates are for air time only.

Production, rehearsal, material, and field pick-up charges will be based upon actual costs.

Film, music, or dramatic talent available on request.

Contracts, program material, and advertising copy are subject to approval according to the standards of station policy. The right to refuse or cancel any of the above is reserved by WWDT.

Closing time on all programs or announcements is 72 hours prior to the scheduled time of telecast. Failure on the part of the advertiser to comply relieves station of all obligation to adhere to the schedule.

## Current Advertisers

**Alexander Stores**—"Let's Play the Game." Through ABC over WABD. Tuesday. Relayed to WTTG. Half hour charade program.

**Alexander Smith Carpet Co.**—"Magic Carpet." WABD, bi-weekly, Friday. Fifteen minute live and film format. Agency, Anderson, Davis & Platte.

**Atlantic Refining Co.**—Penn basketball games. WPTZ, Saturday. Agency, N. W. Ayer & Sons.

**Automobile Manufacturers Association**—"Video Reports to America." Through ABC over WABD. Relayed to WTTG. Special documentary films shot by ABC.

**Borden Co.**—"I Love to Eat." WNBT, Friday. Fifteen minute cooking program. Relayed to WRGB and WPTZ. "Let's Celebrate"—experimental audience participation format. WNBT, Sunday. One time shot. Relayed to WRGB and WPTZ. Agency, Young & Rubicam.

**Botany**—Weather report. WABD, WNBT.

**Bristol-Myers**—"Tele-Varieties." WNBT, Sunday night. Twenty minute variety show plugging Minit-Rub and Trushay alternate weeks. Relayed to WPTZ and WRGB. Agency, Young and Rubicam. "Tales by Hoff," (cartoon show), sponsored by Ipana and "Vitalis Sports Almanac," (films), WCBS-TV, Sunday night. Two shows have now been replaced by "King's Party Line," audience-viewer participation format. Agency, Doherty, Clifford & Shenfield.

**Bulova**—Time spots. WNBT, WCBS-TV.

**Caples Company**—"Faraway Hills." WABD, Wednesday. Half hour dramatic serial.

**Chevrolet**—Hour show. Film and live. WABD, Sunday. Relayed to WTTG. Also scheduled for WWDT, Detroit, when it opens. Agency, Campbell-Ewald.

**Commonwealth Edison Co.**—"Telequizzicals." WBKB, Friday.

Half-hour viewer participation show. Direct.

**Cutter Cravats**—"Sidewalk Tele-Talks." WBKB, Monday. Fifteen minute news format.

**Elgin**—Time spots. Film commercials on WNBT, WABD, WCBS-TV. Live spots, WBKB.

**The Fair**—"Telechats"—news program. WBKB, Friday. Fifteen-minute news program. Christmas shopping format added for five weeks preceding Christmas.

**Firestone Tire & Rubber Co.**—"Voice of Firestone." WNBT, Monday. 10-minute film format. Relayed to WRGB and WPTZ. Agency Sweeney & James.

**Ford Motor Company**—"Parade of Sports." All events, except boxing, from Madison Square Garden. WCBS-TV. Agency, J. Walter Thompson.

**General Electric**—Appliance commercials. WRGB. Spots or in dramatized formats.

**General Mills, Inc.**—Hockey and wrestling. Through ABC over WBKB, Wednesday.

**Gillette Safety Razor Co.**—"Cavalcade of Sports." WNBT, Monday and Friday. Boxing bouts. Relayed to WRGB and WPTZ. Agency, Maxon, Inc.

**Gruen**—Time spots. WCBS-TV.

**Gulf Refining Company**—"Television News." WCBS-TV, Thursday. Fifteen minute live and film program. "You Are An Artist." WNBT, Thursday. Fifteen minute art lesson format. Relayed to WRGB. Agency Young & Rubicam.

**Hirshon-Garfield Agency**—"Detect and Collect." Through ABC over WABD. Thursday. Relayed to WTTG. Half hour audience participation show. Agency accounts alternate in presenting products.

**Longines-Wittnauer**—Time spots. WABD.

**Henry C. Lytton & Sons**—Hockey from Chicago Stadium. Through ABC over WBKB, Sunday. Agency, Ruthrauff & Ryan.

**Marshall Field**—"Marshall Field Theatre." WBKB, Wednesday. Half hour variety program.

**New York Dress Institute**—"Signature Touches of American Fashion Designers." WRGB, bi-monthly, Thursday. Half hour format to test the presentation of fashions.

**RCA Victor**—"World in your Home." WNBT, Friday night. Fifteen minute film program. Relayed to WRGB. Agency, J. Walter Thompson.

**Reid's Ice Cream**—Weather reports. WCBS-TV. Thursday and Sunday. Agency, Doherty, Clifford & Shenfield.

**Sears-Roebuck**—"Visi-Quiz." WPTZ, Thursday. Half hour audience-viewer participation program. "Matinee for Youth." WPTZ, Friday afternoon. Half hour film program. Agency, Benjamin Eshelman.

**Standard Brands, Inc.**—"Hour Glass." WNBT, Thursday. Hour variety show, "Face to Face," WNBT, Sunday. Both programs relayed to WPTZ and WRGB. Quarter hour cartoon show. Agency J. Walter Thompson.

**Standard Oil of New Jersey (Esso)**—"Television Newsreel," WNBT, Monday night. Relayed to WPTZ. 10 minutes of late news films. Agency, Marshalk & Pratt.

**U.S. Rubber Co.**—"Serving Through Science." WABD. Tuesday. Half hour film program. Relayed to WTTG. "The American Home," one time shot over WNBT. Fifteen minute film. "Television Quarterback," sports forecast over WNBT. Relayed to WRGB. Agency, Campbell-Ewald.

**Wanamaker's Department Store**—"Wanamaker Presents." WABD, Wednesday. Half hour shopping merchandise program, presented in cooperation with various manufacturers.



# PROGRAMMING

Analysis of current formats; typical weekly programming schedule of all operating stations.

## NBC EXPERIMENTS

### **Image orthicon tried out successfully by NBC in studio show.**

First test by NBC with image orthicon field equipment for an audience participation studio show proved highly successful. According to Eddie Sobel, NBC producer who directed Borden's "Let's Celebrate," the quality of the picture is good enough for this type of show and compares favorably to the quality of newsreel shots. However for good dramatic shows, when fine grain pictures and good definition are wanted, Sobel still prefers orthicons.

Show was held in NBC radio studio 8G with an audience of 250. Ordinary lighting was supplemented by footlights, a few spots and overhead borders with thorough pre-testing to figure out the effects needed. Two cameras were stationed at the back of the studio, with a third at the right of the stage to pick up audience reaction. Telephoto lens was used for extreme close-ups, with use of medium and close-up lens predominating. In Mr. Sobel's opinion, men who are accustomed to field work, where things happen spontaneously, might do a better job on this type format than the boys who are accustomed to pre-rehearsed studio shows. Aside from operation of the camera itself, field training is particularly useful in an audience participation show when you are never quite sure what is going to happen next, and you must be on your toes to catch the action.

However, where a station plans dual use of field equipment, studios should be built with that in mind. In Mr. Sobel's opinion, mobile equipment lends itself very well to such fast moving shows like audience participation or good comedy and permits a more flexible operation. Dollarwise it cuts down the total initial investment and the amount of personnel necessary—no dollies needed, less confusion in studio, etc. (Review of Borden show on page 22).



Above: "A Comic Strip is Born" and NBC television brings Milton Caniff's latest brainchild "Steve Canyon" to the tele-audience weeks before its newspaper debut. The female menace is the model for "Copper Calhoun." Below: W6XAO toured their audience over the United States via film and skit to give them an insight of the impact of Christmas on Americans. The over-loaded shopper's dilemma is projected here, reminiscent of crowded transportation.



## EDUCATIONAL

### **An analysis of what New York and Chicago are doing on educational shows.**

**WCBS-TV** New York Board of Education junior high school quiz series features ten participants from two different schools each week. In order to insure a high degree of visual appeal, a brochure was prepared jointly by CBS staffers and the Board of Education, giving detailed information on the types of questions to be asked and the best methods for putting them across to the viewers. All quiz material is taken from the syllabus.

Opening shot pans around among the kids who are caught "informally" before the quiz starts. Rules of program are briefly explained and a coin is tossed to determine which team leads off. A score keeper with a youthful adviser from each school is seated on the rostrum, with signposts in back to indicate the score. Since youngsters are picked by IQs and not particularly for video-genic or acting ability, good point in keeping the program going easily and without stilted amateurishness is by having the bulk of the conversation carried by two B of E members, with the youngsters limited to answering the questions.

Visualizations were interesting and problems adult enough to keep the graduate members of the viewing audience guessing. Here are some typical examples and their visualizations:

A large poster showing a sphinx, the Eiffel Tower, the Empire State Building and the Taj Mahal was shown with the youngsters required to name the countries represented on the placard. Next, five items were displayed on a table, the problem being to number them in order of their development. (Articles included the telephone, steam engine, wheel, iconoscope, etc.) There were three clues given for the "What's my name" problem, with the points diminishing accordingly—first illustration was of old Fort Duquesne, second of the steel industries, and third was a map showing its position. (Answer was Pittsburgh). Pairs of words were placarded on a board, with youngster required to identify

them as antonyms, synonyms or homonyms, tested grammar. Astronomy was visualized with three youngsters acting the part of the sun, moon and earth (without costume!) revolving around each other, with the contestant stopping them in position for a solar eclipse.

Program forms an interesting enough half hour, with camera focusing on the visualizations, then picking up sideline reactions, and the score-board at the end of each problem.

Show is a good example of cooperative programming between stations and school systems and points up the fact that pre-preparation pays dividends, especially when dealing with amateurs. While kids are unrehearsed except for positions, much of the pre-planning was given to visualizing the show.

**WBKB's** "Minor Opinions" is produced in cooperation with the Gary Public School System. Format consists of a current events quiz, with the "class" made up of six youngsters ranging in age from six to nine years. They give their viewpoints on such weighty problems as politics, housing, sports, business, education, etc., and some not-so-profound ones as staying up late and washing dishes. "Cast" changes every week. Fifteen minute weekly show is produced and directed by Pauline Bobrov.

**W6XAO's** plan of stimulating interest in television among the schools in Southern California resulted in the UCLA student presentation of "The Christmas Spirit of 1946." Combining film and live, format took the form of a pageant, in a survey of the United States as it prepared for another Christmas season.

## PARTICIPATION

**"King's Party Line," CBS sustainer, bought by Bristol-Myers (Ipana and Vitalis).**

**WCBS-TV's** "King's Party Line" opens with a series of cartoons which successfully establishes the mood and format of this guest and telephone participation show.

John Reed King seems a little less effusive than usual which adds to the visual program. First shot shows him seated at a desk on which is hung a huge sign which gives home viewers a look at the telephone number of WCBS-TV. Unfortunately, the camera failed to pick up the last digit of this important bit of information, which, however, was transmitted vocally as well. Smaller sign or a longer shot might correct this. The guests who participated in this program numbered five: a dancing school instructress, a vet, a Mrs. Martini from the Bronx Zoo, and a young man and lady. King's assistant helped put everybody at ease, bringing tall iced drinks to the guests, and then King addressed the studio and outside audience giving an explanation of what he expected from them. He asked especially for those who viewed him outside the theoretical fifty-mile limit to so inform him.

Telephone bells rang constantly throughout so instantaneous was the response to this program which apparently is a favorite among television receiver owners. Each correct answer received a five dollar reward which isn't a bad investment for a nickel. King involved a guest in most of the questions. For example, he had the dancer perform a dance question using only two dancing fingers. This was a good visual question. As a gag he had the dancing teacher get up with the veteran and do a short snappy dance together. A geography question which required paper and pencil and quick thinking followed this. A good point here was the use of superimposition of the written answer over King's face while he explained the solution.

The woman from the Zoo supplied another visual question by placing two small animals on a desk. Another audiovisual question involved playing of a popular vocal record while a number of pictures of popular songstresses were picked up by the camera. Final stunt on the program carried a reward of fifty dollars for guessing the identity of a partially blanked out photograph. The answers to this most lucrative question were acceptable for thirty minutes after termination of the program. Reasons for the final question carrying the heaviest reward was to compensate in part for viewers receiving the busy

signal during the program. The heavy telephone traffic is one problem that WCBS-TV is attempting to solve so that viewers will not be annoyingly frustrated. Program was directed by Miss Frances Buss.

**WRGB's** "Picture Puzzles" is a "what's wrong with this" quiz presented as a regular feature over the station. In the fifteen minute segment, three historical events are dramatized. Mistakes are intentionally made in clothing, customs, etc. Board of three experts are asked after each dramatization to tell what was wrong with each presentation.

## CURRENT

**NBC's "Screen Magazine" integrates three or four shorts in one program; WPTZ tries ballet.**

**WNBT's** "Television Screen Magazine" wraps up three or four shorts into one package. Fare, on night segment was reviewed, included a documentary newsreel on the inauguration of the Mexican president; "The Magic of Electronics," a studio show; a preview showing of a film taken by the French Underground during the German occupation, and Milton Caniff introducing his new comic strip "Steve Canyon." Each segment was introduced by a title in the form of a magazine page, with the headline and accompanying sketch or illustration.

"The Magic of Electronics" featured Gordon Volkenant, distinguished electronic lecturer, who attempted to clarify and simplify the electronic theory for the laymen. Show opened with close-up of lecturer, switching to a view of the table on which various electronic tubes and gadgets were displayed. Lecture was accompanied by demonstrations of the parts which the camera caught in close-up. Evaluation of an educational show of this type would depend upon the interests of the audience. First part, an explanation of electronics in terms of bent hairpins, tin cans and glass jars, was not as simple as it sounded and seemed overlong. Demonstration of electronic de-



John Reed King's Party Line keeps the telephones ringing during the popular half hour questionnaire on WCBS-TV. The double telephone hook-up permits King and guest to engage in a three-sided conversation with the home-viewer.

vices, however, was interesting.

"A Comic Strip Is Born" featured cartoonist Milton Caniff, introducing the main characters in his new strip, "Steve Canyon," scheduled to start January 15th, in the New York Daily Mirror. Seated before the easel, cartoonist Caniff drew Steve Canyon, as he explained the plot and pointed out the characteristics of his new red-blooded hero. Easy patter back and forth with emcee Eddie Dunn feeding the questions gave a good air of informality to the seg and close-up shots of Steve as he came into being under Caniff's hand added high visual interest. The menace, "Copper Calhoun" was there in the person of Miss Utah who modeled for the sultry siren. Here the camera varied between shots of the in-the-flesh and on-paper she-wolf. Tie-up here was highly promotional, with the Daily Mirror giving the television appearance of Caniff some good space and the program mentioning the Mirror and the date strip starts.

**WPTZ's** first attempt at ballet used the famous "Danse Macabre" as musical theme and featured three dancers performing their ballet against a background of a graveyard. This effect was achieved by the superimposition of two pic-

tures throughout the program, with one camera focused on a miniature graveyard setting, and the other following the dancers. Show was directed by Herb Horton.

**WRGB's** "Glance at the Headlines" is another in their series of experiments on news presentations. This time, show opened with an enlarged piece of ticker tape, bearing the headline of the story, pulled before the camera. Don Patrick, commentator, followed with a short explanation of the news.

**WNBT's** "Let's Rhumba" features D'Avalos in a weekly fifteen minute dance instruction program. Even without the introductory title one would recognize from the accent and slick hair that D'Avalos was a master of the rhumba. However, he exhibits a patience which is not generally associated with a Latin temperament. Accompanied by a beautiful partner, he goes through some of the basic rhumba steps and succeeds in conveying some of the essential movements of this popular exercise. Television is an extremely good medium for transmitting dance lessons because it can obviate self-consciousness in the privacy of one's home and that is one of the greatest stumbling blocks in dance instruction.



Special Christmas program, presented by John Wanamaker's, featured Bob Emory and was presented over WABD the four Saturdays preceding Christmas. Three elaborate sets were used and each child was presented with a badge certifying that he had appeared on television with Santa Claus.

## FASHION AND BEAUTY

### **Movie fashions and makeup demonstrations dramatized over W6XAO.**

**W6XAO's** "That's Hollywood" combined fashion and make-up in a dramatized skit of the steps that go into glamorizing a girl for a screen test. Offscreen announcement on the glamor of Hollywood and the many young hopefuls who beat their way there, set the stage. Opening scene showed Shirley O'Hara scheduled for a screen test standing nervously before Mitch, the talent head. After back and forth patter which give her background, Mitch told her she had no glamor and summoned a coterie of costume and make-up people to do her over. The make-up man remade Shirley, discussing the angles of her face, and explaining the whys of each step. In short it was a demonstration of correct make-up for the movies. Next came Renee, the costume designer, and after discussing the type of clothes for Shirley's figure, invited them over to Set 23 to see the style show being shot for a picture. This introduced the fashion parade, with each

model posing in the doorway, then walking down the stairs and across the lawn while Renee described the costume. On returning to Mitch's office, comedy note was introduced with a young actor and his voice teacher breaking in and demanding an audition.

Next on the scene was the hair stylist who surveyed Shirley's hair, tried it several ways while explaining the correct hair style, the relation of hair style to the shape of the face, etc. With Shirley glamorized from the neck up, next step was her gown and while she was getting ready, the second part of the fashion show was given.

Climax of the show was Jane Greer's creation, with Jane joining the group and reminiscing about her own screen test days. Show closed with Shirley posed and in place for her test.

Credits, given by the announcer as the scene faded out, gave the name and studio affiliation of the cast, as well as credit for the clothes, furs, hats, etc. Obviously, this type of program, if done with restraint has tremendous commercial possibilities.

## CHRISTMAS SHOWS

**Shows tele at its best in capturing Christmas spirit; remotes, studio plays and special films featured.**

**WABD** John Wanamaker's presented Bob Emory in a Christmas program, shown three times in the 12 to 2:30 spots on the four Saturdays preceding Christmas. Special Christmas presentation for children was made with genial Bob Emory handling long lines of children as he inducted them into the John Wanamaker's Santa's Television Club of 1946.

Program started with the title "John Wanamaker Presents" embellished with a wreath and a flash to Santa Claus, then a list of credits, and finally Bob Emory acting as big brother, welcomed his youthful audience. Following this welcome, an adorable group of children sang a Christmas carol against a snow-covered background while artificial snow fell down on them from the studio roof. Actual voices were recorded on a platter and synchronization of this number was excellent. The caroling was followed by a few stunts in which selected children from the audience participated.

Jerry Iger, cartoonist-author of "Pee-Wee and the Sneezing Elephant," selected four children from the audience, asked for their initials and then drew laugh-provoking sketches with their initial as the core. Each child who participated was presented with a copy of his book and a sketch. Then all the children in the audience (it appeared as though there were thousands) were lead past Santa Claus who presented each of them with a card certifying that they had appeared on a television program with Santa. The wondrous expression that can appear only on children's faces when confronted with the spirit of Santa Claus did not escape the television cameramen. One amusing, or perhaps slightly jarring note occurred when a five-year-old who was theoretically passing through Santa's winter workshop, said, "Boy, it's hot down here!"



**WNBT's** mobile equipment televised the crowds in Gimbel's toy department, roaming around to pick up the merry-go-round, the milk bar, the mechanical toys, and the usual Christmas displays. Climax of the remote was Santa himself, listening to the youngsters and distributing gifts . . . Another "Christmas spirit" trip was made to the General Post Office to show the volume of mail handled during the holiday rush. One camera was located below the incoming parcel post window in the Post Office building and a second on the floor below where packages are brought down on conveyors — the so-called "Niagara Falls" of the post office. Rockefeller Center Choristers were televised at Rockefeller Plaza. Two cameras were used to pick up the candlelight procession to the platform in the Plaza. Musical program included all the favorite Christmas carols.

"The Night Before Christmas," based on a story from Coronet Magazine which dramatized how the now-classic lines of the poem were written, was presented by the Veterans Production Group of the American Theatre Wing . . . First combination studio-remote show at NBC, "According to Joseph," opened with a mobile pick-up from Rockefeller Plaza, moved into the studio, and then returned to the field.

On Christmas Day, Wanamaker presented "Music for a Christmas Night," followed by "A Goblin's Christmas" with the Suib Marionettes.

**WRGB** kept the Christmas spirit with a playlet, "Santa's Whiskers" and a musical program, "Susan's Xmas Town."

**WCBS-TV's** program schedule was also flavored with the Christmas touch. On the Ipana "Shorty" program, cartoonist Syd Hoff took Shorty on a trip to the North Pole to see Santa Claus. On Christmas Day, special program opened with the American premiere of a Czechoslovakian musical film. Puppets, animation and live action dramatized a little girl's dream. This was followed by a choir singing Christmas music. "Desert Shall Rejoice," modern version of the Nativity, which was presented last year, was repeated this year with the same cast. Setting, a la "The Petrified Forest," was a combination gas station, tourist camp and restaurant. Greek who ran the station sent away to the nearest big city to purchase the electric star sign from a defunct theatre. Star rose fifty feet over his restaurant, lighting up the desert. Various characters wander in and out—a young couple whose car broke down, cowboys who ride 18 miles to trace the source of the wondrous star, a doctor, etc. Spirit of Christmas is built throughout,

with the Greek who doesn't believe in Christmas finally succumbing by giving his wife a gift. Show was directed by Ben Feiner.

**W6XYZ's** mobile equipment televised the Christmas Day high mass directly from the church out in Los Angeles.

Commercial shows featured Christmas themes for the week preceding Christmas as well as the holiday week itself. In addition, special motion pictures were shown, such as films of Santa Claus, Inc. (presented by Firestone), and the party given in Washington for children of the Diplomatic Corps.

Christmas carols were musical background for test pattern and a series of Christmas slides were used to visualize the carolling at the sign-offs.

**ABC** featured Johnny Olsen in a special Christmas Eve party over WABD for the youngsters. In cooperation with the Kiwanis Club 50 children attended the party, participated in games, and were fed candy, cake and ice cream. ABC show over WPTZ the previous week featured Vera Massey in a special Christmas Carol program.

**WABD's** remote equipment picked up the candlelight procession and carol service from Grace Church on Christmas Eve, which was sponsored by U. S. Rubber Company.

## Typical Weekly Programming

### MONDAY

P.M.  
 12:00- 3:00 Special Program — for RCA Victor television dealers (studio, film, remote) **WBKB**  
 1:00- 4:00 I.N.S. News, Music and test pattern **WABD**  
 7:30- 7:45 Minor Opinions—Gary Public Schools **WBKB**  
 7:30- 7:50 American Indian Lore—Museum Natural History **WRGB**  
 7:45- 8:00 Short Subjects (film) **WBKB**  
 7:50- 8:00 Lapland No. 2—Mrs. Carveth Wells (film) **WRGB**  
 8:00- 9:00 Little Men (film) **WABD**  
 \*The Bad Men of Thunder Gap **WPTZ**  
 The Bad Men of Thunder Gap (film) **WNBT**  
 \*The Bad Men of Thunder Gap **WRGB**  
 8:00- 8:15 Judy Talbot's Variety Show Case **WBKB**  
 8:15- 8:30 Short Subjects (film) **WBKB**  
 8:30- 8:45 Behind the Headlines **WBKB**  
 8:30 The Christmas Spirit of

1946—(film and live); cartoons, film shorts **W6XAO**  
 8:45- 9:00 Short Subjects (film) **WBKB**  
 9:00-11:00 Amateur Boxing — Jamaica Arena **WABD**  
 9:00 Adam vs. Eve (participation) **WBKB**  
 9:00- 9:10 Esso Reporter—news-reel **WNBT**  
 \*Esso Reporter **WPTZ**  
 \*Esso Reporter **WRGB**  
 9:10- 9:20 Voice of Firestone (film) **WNBT**  
 \*Voice of Firestone **WPTZ**  
 \*Voice of Firestone **WRGB**  
 9:20-11:00 Gillette Cavalcade of Sports—boxing from St. Nicholas Arena **WNBT**  
 \*Cavalcade of Sports **WPTZ**  
 \*Cavalcade of Sports **WRGB**

### TUESDAY

P.M.  
 12:00- 3:00 Special Program — for RCA Victor television dealers (studio, film, live) **WBKB**  
 1:00- 4:00 I.N.S. News, Music and

Test Pattern **WABD**  
 Midwest Tele-Topic Forum — Howard Williams **WBKB**  
 7:30- 7:45 Short Subjects (film) **WBKB**  
 7:45- 8:00 A Dance Program **WRGB**  
 7:30- 7:50 A Glance at the Headlines — Don Patrick **WRGB**  
 7:50- 8:00 ABC "Play the Game" — Alexanders (characters) **WABD**  
 \*\*\*"Play The Game" **WTTG**  
 8:00- 8:30 Clay Modeling — Egon Weiner **WBKB**  
 A Date With A Tank — (film) **WRGB**  
 8:00- 8:15 Short Subjects (film) **WBKB**  
 8:15- 8:25 The Jolly Three **WRGB**  
 8:30- 9:00 Short (film) **WABD**  
 8:30- Tommy Bartlett Time (variety) **WBKB**  
 8:30- 8:40 Paramount News (film slides) **W6XYZ**  
 8:25- 8:40 Statue Parade (film) **WRGB**  
 8:40- 9:00 Picture Puzzles **WRGB**

Your Town — Testing for Better Streets (forum) W6XYZ  
 9:00- 9:30 U.S. Rubber — Serving Through Science (film) WABD  
 \*\*Serving Through Science WTTG  
 9:00- Basketball—Pan Pacific Auditorium W6XYZ

**WEDNESDAY**

P.M.  
 12:00- 3:00 Special Program — RCA Victor Television Dealers (studio, film, remote) WBKB  
 1:00- 4:00 I.N.S. News, Music and Test Pattern WABD  
 7:30- 7:50 "On the Job" — Red Levy WRGB  
 7:30- 7:45 Associated American Artists WBKB  
 7:45- 8:00 Short Subjects (film) WBKB  
 7:50- 8:15 "Keep Fit Through Wrestling" and "Land of Eternal Silence" (film) WRGB  
 8:00- 8:30 The Doll Theatre — Wanamaker's (children's variety) WABD  
 \*\*The Doll Theatre WTTG  
 Marshall Field Theatre — Don McNeill WBKB  
 "Toyland" — pick-up from Gimbel's WNBT  
 8:15- ABC Sports — Ice Hockey from Philadelphia Arena WPTZ  
 WRGB Hoe-Down Night WRGB  
 8:30- 9:00 Shorts (film) WABD  
 \*\*Shorts WTTG  
 8:30- Hockey — ABC-General Mills WBKB  
 Film Features WNBT

Ice Hockey — Pan Pacific Auditorium W6XYZ  
 9:00- 9:30 Faraway Hill (dramatic serial) WABD  
 \*\*Faraway Hill WTTG  
 9:30-11:00 Professional Boxing — Jamaica Arena WABD  
 \*\*Professional Boxing WTTG

**THURSDAY**

P.M.  
 12:00- 3:00 Special Program — for RAC Victor Television Dealers (studio, film, remote) WBKB  
 1:00- 4:00 I.N.S. News, Music and Test Pattern WABD  
 7:30- 7:35 G-E Appliance Commercial WRGB  
 7:30- 7:40 Over Shoemaker's Shoulder (cartoon format) WBKB  
 7:35- 7:50 Christmas Playlet — "Santa's Whiskers" WRGB  
 7:40- 8:00 Winners of the West — Episode 11 WBKB  
 7:50- 8:00 NBC Television Newsreel WNBT  
 \*NBC Television Newsreel WPTZ  
 \*NBC Television Newsreel WRGB  
 8:00- 9:00 Standard Brands' Hour Glass (variety) WNBT  
 \*Hour Glass WPTZ  
 \*Hour Glass WRGB  
 8:00- 8:30 Hirshon-Garfield's Detect and Collect — ABC participation) WABD  
 \*\*Detect and Collect WTTG  
 8:00- 8:15 Cavalcade of Medicine —A.M.A. WBKB

8:15- 8:30 Short Subjects (film) WBKB  
 Gulf News (film and live) WCBS-TV  
 8:30- 9:00 Short (film) WABD  
 8:30- Variety WBKB  
 8:30- 9:00 Junior High School Quiz WCBS-TV  
 9:00- 9:30 Cash and Carry (quiz) WABD  
 \*\*Cash and Carry WTTG  
 9:00- 9:30 Sears Visi-Quiz (participation) WPTZ  
 9:00- Basketball — from Madison Square Garden WCBS-TV  
 Basketball — from Pacific Auditorium W6XYZ  
 9:00- 9:15 You Are An Artist (Gulf) — Jon Gnagy (art lesson) WNBT  
 \*You Are An Artist WRGB  
 9:15- Christmas Film WNBT  
 9:15- \*Christmas Films WRGB

**FRIDAY**

P.M.  
 12:30- 3:00 Special Program — for RCA Victor Television Dealers (studio, film, remote) WBKB  
 1:00- 4:00 I.N.S. News, Music and Test Pattern WABD  
 4:00- 5:00 Sears Matinee for Youth (film) WPTZ  
 7:30- 8:00 What Men Live By — play WRGB  
 7:30- 7:45 Tele-Chats — The Fair (news) WBKB  
 7:45- 8:00 Short Subjects (film) WBKB  
 8:00- 8:30 Date with Destiny — American Television Society WABD  
 "Telequizzicals" — Commonwealth Edison Co. (participation) WBKB  
 8:00- 8:15 The American Home — U.S. Rubber (film) WNBT  
 8:00- 8:20 \*The American Home WRGB  
 8:00- ABC Rumpus Room — Johnny Olsen (participation) WPTZ  
 8:15- 8:30 Let's Rhumba — D'Avallós WNBT  
 8:20- 8:30 Let's Rhumba WRGB  
 8:30- 9:30 Silver Devil (film) WABD  
 8:30- 8:46 I Love To Eat — Borden (cooking format) WNBT  
 8:30- 8:45 Susan's Xmas Town (musical) WRGB  
 8:30- Ice Hockey — Pan Pacific Auditorium W6XYZ  
 Boxing Bouts — Rainbo Arena WBKB  
 8:45- 9:00 The World in Your Home — RCA Victor (film) WNBT  
 \*The World In Your Home WRGB  
 9:00-10:00 Gillette's Cavalcade of Sports — boxing from Madison Square Garden WNBT

(Continued on page 39)

WRGB unveiled the latest in mechanical pickers. This one, for de-feathering chickens, was demonstrated by its inventor John Guertze, a 16-year-old 4-H farm boy, who beat his hand-picking rival by a ratio of five to one.



# FILMS

News coverage consistently beats newsreels

It won't be long before television will scoop the newsreels daily, judging from the recent "firsts" that have been appearing on station's news telecasts. Good example was the recent New York City holocaust, where fire and explosion ripped open a 22-family tenement. Camera crews of NBC, ABC and CBS were on the job, with film shown over all three stations—WNBT, WCBS-TV and WABD (through ABC)—that night.

Quick film showings of news events is not limited to local areas alone, however. Through free-lance cameramen, NBC's Paul Alley secured films of such high-interest events as John L. Lewis' courtroom appearances, and the Europa sinking at Le Havre for pre-newsreel showing over WNBT. Paul Mowery, ABC's television head, exhibited quick thinking in securing coverage of the Mansfield, Ohio train wreck. He immediately wired station WMAN, an ABC affiliate, to put a spot announcement on the air asking for films which had been taken of the disaster. Response to the spot announcements resulted in the acquisition of several hundred feet of film which was immediately flown by special chartered plane to Cleveland, Ohio. From there, it was picked up by regular transport and delivered to ABC in New York. The next afternoon film, edited and timed to a live studio narration, was presented by ABC over WABD, and sponsored by U. S. Rubber Co.

Year-end compilations of important events got a new twist with the Esso-sponsored "Silly Side of '46." Such laugh-provoking stunts as the Shaving Derby, the Skating Derby, the story of the human icicle and the Baby Beauty Contest were included. Other round-ups included the sports thrills of 1946 and the news in review.

## Typical Reel

Here's a sample reel, which is typical of the fare that goes into these weekly Esso-sponsored ten-minute programs:

"John L. Lewis Wins 10-day Delay" — scenes of Lewis leaving Washington court; workmen leaving jobs and trains idle in yards; dim-out on Broadway.

"Navy Begins Operation Zipper" — Airviews of USS Washington, Alaska, Guam and Wasp as job of sealing ships gets underway. Deck close-ups of how vessels are encased in cocoon-like moisture-proof plastic.

"Rocket Camera Films Earth 8 Miles Up" — Sensational pictures from White Sands Proving Grounds, New Mexico, showed U.S. Army Air Forces cooperating with Johns Hopkins University in filming earth from tail of a blazing rocket. Scenes were caught by the automatic movie camera as it rushed skyward at rate of 4,000 feet per second.

"Movie Stars Home from Command Performance" — Arrival of Pat O'Brien, Reginald Gardner, Madeline Carroll on the Queen Elizabeth after special command performance before King and Queen of England.

"Thanksgiving 1946 — a Day of Re-Dedication" — Scenes taken by NBC cameramen inside a little New England Church.

## Tele-Movie Tie-Ups

Good sign that tele and movies are going into the courting stage is evidenced by two pre-opening showings of films before their theatre debuts. One was "Operations Underground," shot in Paris during the war, and produced by Telenews Production. Film was shown over WNBT and relayed to WPTZ and WRGB prior to its opening at the

Embassy Theatre. W6XAO is also scheduled to show "New Orleans," before its official opening.

CBS also featured the American premiere of a Czechoslovakian film, "Christmas Dream," which was telecast on Christmas Day. Film was obtained from the Czechoslovakian film exchange.

## Documentaries

First film in ABC's series of "Video Reports to America," was produced in cooperation with the Automobile Manufacturers Association. Cost of this film to ABC was \$10,000—which was low for a 30-minute production. About 20% of the picture was made of shots from various motor companies' libraries. Film was on 35 mm. stock with sound track added.

Titled "New Cars," film left no doubt about the multiple problems confronting the automobile industry. It capably projected the interdependence of all branches of industry with shots of agriculture, mines, steel mills right down to final assembly lines. Good use was made of animated diagrams to back up the point. International angle was explained with film clips of workers in foreign countries assembling American watches.

After its tele showing over WABD, WTTG, WPTZ, WRGB, and WBKB, the AMA plans to distribute the film on a nation-wide basis.

Future subjects in the series will be "Housing in the U. S.," "The American Merchant Marine," "Labor and Management," and "Public Health." Harvey Marlowe is producing the series for ABC.

## In the Making

Some government agencies are considering producing educational films for television much as they turn out shorts for the movies . . . The National Association of Broadcasters and the National Retail Dry Goods Association are working on a joint project to film television commercials for use by prospective TV sponsors. It seems that several department stores have indicated a willingness to sponsor TV but are at a loss to prepare commercials.

no platitudes  
no rosy prophecies  
just solid fact

every month. **TELEVISION**  
magazine will bring you a full  
report on all significant developments  
in the industry whether  
it be FCC actions, advertising,  
equipment news, programming,  
station operation, films, etc.

\$4.00 for a year's subscription  
send in the attached card today

# EQUIPMENT

Cost comparisons of UHF and VHF equipment; diagrams of CBS dual band receivers—patents

WHILE costs on station equipment have appeared in these pages many times before, the following figures presented by CBS in recent testimony before the FCC in the color hearings, are a fair and concise recapitulation of station costs.

## CAPITAL COSTS OF VHF BLACK AND WHITE AND UHF COLOR TELEVISION STATIONS

Master Station (Metropolitan)	Avg. Costs Based on Washington, D. C. TV Hearings			WOR NY, TV Station	UHF Color TV <sup>2</sup> (Presently Available Equipment)
	RCA	G.E. Co.	Los Angeles, Calif. TV Hearings		
Equipment .....	\$327,240 <sup>1</sup>		\$386,218	\$395,000	\$427,400
General Construction (other than equipment) .....	350,000 <sup>2</sup>		535,517	248,500	350,000
Total .....	\$677,240		\$921,735 <sup>1</sup>	\$643,500 <sup>2</sup>	\$777,400
<b>Standard Station</b> (Metropolitan)					
Equipment .....	\$225,640 <sup>1</sup>	\$225,000 <sup>1</sup>	\$254,625		\$305,675
General Construction .....	246,000	246,000	202,219		246,000
Total .....	\$471,640	\$501,000	\$456,844 <sup>1</sup>		\$551,675
<b>Small Station</b> (Community)					
Equipment .....	\$162,390	\$135,000 <sup>1</sup>			\$229,150
Construction .....	140,000	120,000			140,000
Total .....	\$302,390	\$255,000			\$369,150

### Breakdown of Equipment Costs

Facilities	VHF Black & White	UHF Color
<b>Equipment for a Master Television Station</b>		
1. Studio and studio control room equipment (2 main studios) .....	\$126,950	\$142,650
2. Film projection and film control room equipment .....	48,700	80,150 <sup>1</sup>
3. Master control room equipment .....	15,200	15,200
4. Announce studio .....	11,250	17,000
5. Transmitting equipment .....	87,400	126,150
6. Field pickup equipment .....	37,740	46,250
	\$327,240	\$427,400
<b>Equipment for a Standard Television Station</b>		
1. Studio equipment .....	\$36,700	\$31,325
2. Film equipment .....	36,100	46,900 <sup>1</sup>
3. Control room equipment .....	27,700	55,050
4. Transmitting equipment .....	87,400	126,150 <sup>2</sup>
5. Field pickup equipment .....	37,740	46,250
	\$225,640	\$305,675
<b>Equipment for a Small Television Station</b>		
1. Portable field equipment .....	\$37,740	\$46,000
2. Film equipment .....	17,550	23,500 <sup>1</sup>
3. Studio control room .....	19,700	33,500
4. Transmitting equipment .....	87,400	126,150
	\$162,390	\$229,150

Note (1) Does not include 35 mm projectors.

Note (2) Based on a separate transmitter for the sound channel and including antenna but not antenna supporting structure. If duplex modulation is used the color transmitter cost may be reduced by \$39,000.

(1) RCA equipment costs are based on information obtained from the New York Sales Office of RCA and represent those facilities described in the RCA Sales brochure as "Equipment Layout for a Master Television Broadcast Station." Two studios are contemplated. CBS estimates covering spare parts, test equipment and other necessary accessories are included.

(2) Color television equipment costs are based on information obtained from the Federal Telephone and Radio Corporation, the Federal Telecommunications Laboratories and the Westinghouse Manufacturing Company, plus considerable experience in the CBS Engineering Research and Development Laboratory where prototypes of major components have been designed and built for an entire color transmission system. The facilities for the three u-h-f color stations are comparable respectively to those of the RCA "master," the "standard" and the "small" station.

(3) General construction costs are based on CBS experience at television station WCBS-TV (formerly WCBW) and represent an average of such costs as estimated by all of the applicants in the Washington, D. C., and Los Angeles, California, TV station hearings held before the FCC Dockets 7014 and 6370.

(4) This includes the average cost of facilities proposed by applicants at the Los Angeles v-h-f television hearing. The Times-Mirror Company and Television Productions, Inc., costs are not included, because they were not considered typical.

(5) The proposed WOR New York v-h-f TV station estimated costs cover facilities not claimed comparable to the RCA and the u-h-f Color "Master" Station facilities proposed. However, the WOR costs are indicative of expenditures necessary to construct a commercial Metropolitan TV station.

(6) RCA standard station equipment costs, in this case, are based on information received from the New York sales office of RCA and represent those facilities described in their sales brochure, entitled "Equipment Layout for a Standard Television Broadcast Station." One studio is contemplated. CBS cost estimates covering spare parts and tubes, test equipment and other necessary accessories, are included.

(7) The General Electric Company equipment costs are based on their written cost estimates covering a Metropolitan Television Station, their letter of October 22, 1946. In this case, an announce studio, in addition to the main studio, is included, which probably accounts for their costs being in excess of those provided by RCA.



# Professional Directory

**RING & CLARK**

*Consulting Radio Engineers*

WASHINGTON, D. C.

Munsey Bldg. Republic 2347

**FRANK H. McINTOSH**

*Consulting Radio Engineers*

710 14th ST., N. W. ME. 4477

WASHINGTON, D. C.

**McNARY & WRATHALL**

*Consulting Radio Engineers*

National Press Bldg. DI. 1205

WASHINGTON, D. C.

**JANSKY & BAILEY**

*An Organization of  
Qualified Radio Engineers  
DEDICATED TO THE*

*Service of Broadcasting*

National Press Bldg., Wash., D. C.



**COMMERCIAL RADIO  
EQUIPMENT CO.**

*Radio Engineering Consultant  
Complete engineering services for  
applicant, owners, and operators of*

**AM—FM—and Television**

**Broadcasting Stations**

International Building, Washington, D. C.  
321 E. Gregory Boulevard, Kansas City, Mo.  
Cross Roads of the World, Hollywood, Calif.

**WORTHINGTON C. LENT**

*Consulting Engineers*

International Bldg. Wash., D. C.

1319 F Street, N. W. District 4127

**WELDON & CARR**

*Consulting Radio Engineers*

WASHINGTON, D. C.

1605 CONNECTICUT AVENUE

Phone—Michigan 4151

**GEORGE C. DAVIS**

*Consulting Radio Engineer*

Munsey Bldg. District 8456

WASHINGTON, D. C.

**JOHN CREUTZ**

*Consulting Radio Engineer*

319 Bond Bldg. REpublic 2151

WASHINGTON, D. C.

**GARO W. RAY**

*Consulting Radio Engineers*

991 Broad Street Bridgeport, Conn.

Phone 5-2055

**DIXIE B. McKEY  
& ASSOCIATES**

1730 Connecticut Avenue  
N.W. Washington 9, D. C.

Telephone: Adams 3711

Dixie B. McKey  
Dabney T. Waring, Jr.

**JOHN BARRON**

*Consulting Radio Engineers*

*Specializing in Broadcast and  
Allocation Engineering*

Earle Building, Washington 4, D. C.

Telephone NAational 7757

**HOYLAND BETTINGER**

*Television Consultant*

*Studio Design, Lighting,  
Personnel Training*

595 Fifth Avenue PLaza 8-2000

**BROADCASTING STUDIOS**

*Design and Construction*

Television, also F.M. and A.M.

**THE AUSTIN COMPANY**

Cleveland

A Nation-Wide  Organization

**PROFESSIONAL DIRECTORY**

Open to Engineers and  
Consultants only

Rates \$72 per 12 insertions

(8) This includes the average cost of facilities proposed by applicants at the Washington, D. C., v-h-f television hearing. Excluded from the average were the estimated costs of the WWDC and Evening Star proposals which were not considered typical. The facilities proposed at Washington, D. C., are not entirely comparable to those appearing in the RCA, G. E. Company and u-h-f color columns.

(9) The General Electric Company equipment costs for a small or Community station include less facilities than the RCA and u-h-f color proposals (no live talent main studio or field equipment). The latter proposals are based on a station layout as described in the RCA sales brochure entitled "Equipment Layout for a

Small Television Broadcast Station." The General Electric Company station facilities proposed are for a satellite or network repeater station.

Note: The radiated power in the case of RCA equipment is assumed to be 15 kw for video and 7½ kw for sound for channels 1-7 inclusive, and slightly less than 40 kw video radiated power and slightly less than 20 kw radiated power for sound for channels 8-13 inclusive. The effective radiated power of the General Electric Company equipment is assumed to be approximately 25 kw for video and 12½ kw for sound for all v-h-f TV channels. The effective radiated power of the u-h-f color transmitting equipment is assumed to be 15 kw for video and 7½ kw for sound.

## DUMONT SHOWS NEW TUBES

Experimental model of a Trichromoscope Tube, developed by Dumont Laboratories, was shown to FCC members recently. This cathode ray tube has three bases, equipped with either filters or various colored phosphors, focused on a common screen by means of three lenses and fed from identical scanning signals. Further development work is being done on the tube in order to increase the face size and to utilize higher operating voltages. Use of the Trichromoscope would mean only one cathode ray tube in-

# Comparison of CBS Color and Black and White Equipment

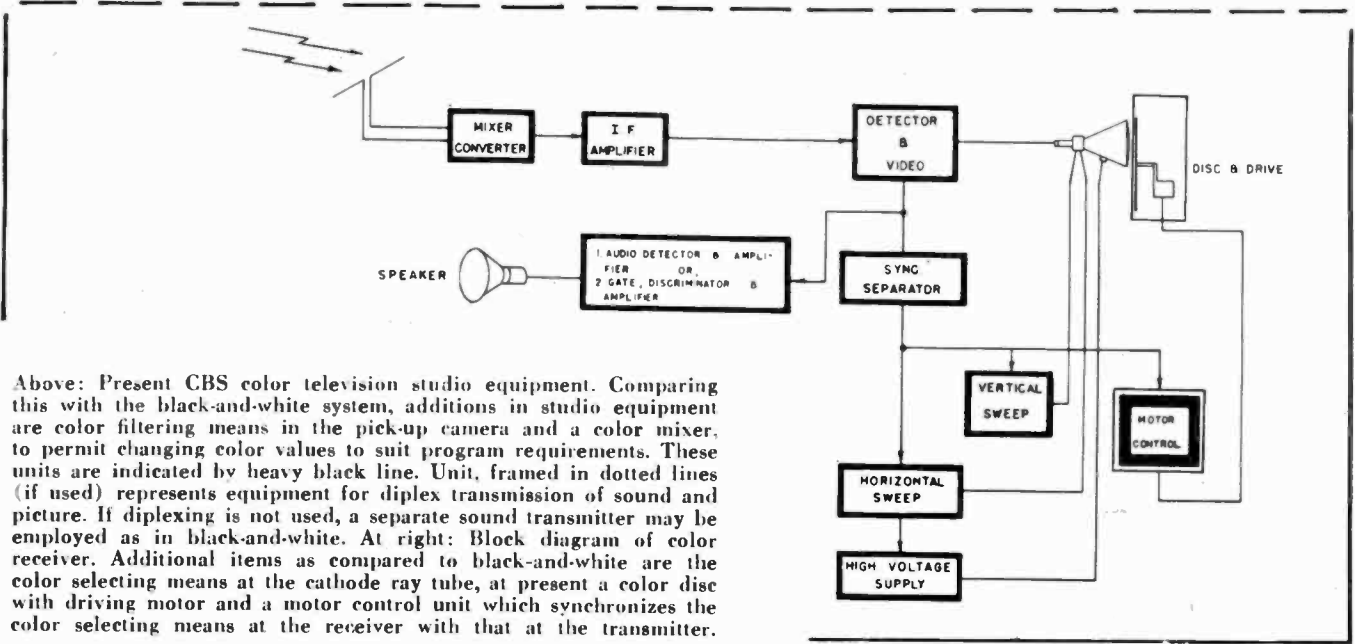
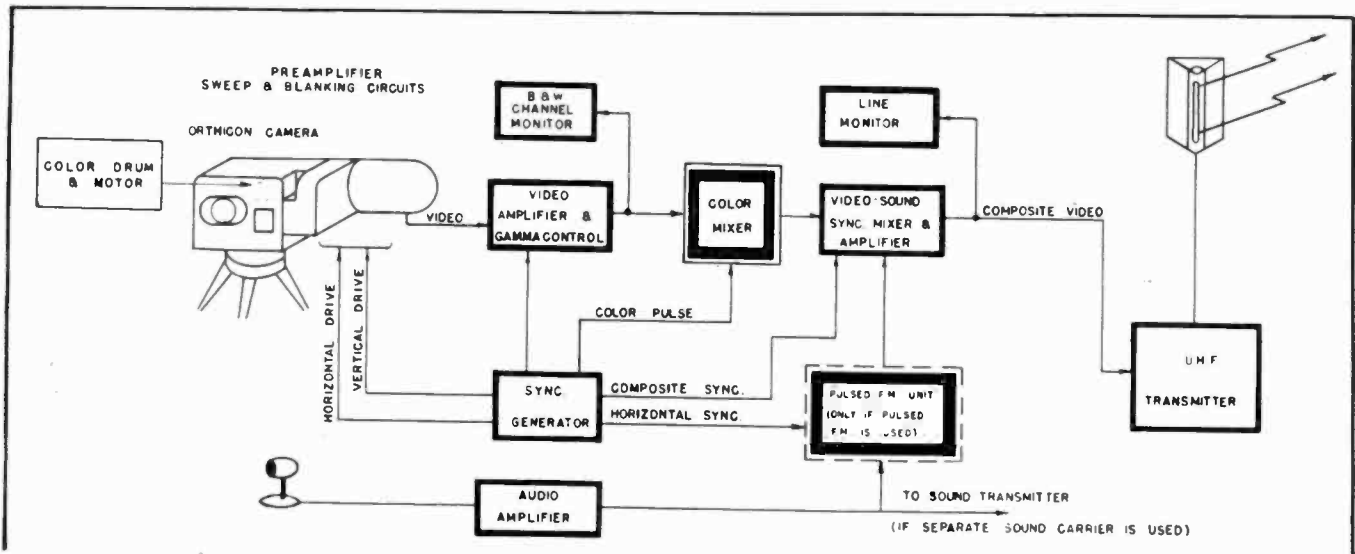

Above: Present CBS color television studio equipment. Comparing this with the black-and-white system, additions in studio equipment are color filtering means in the pick-up camera and a color mixer, to permit changing color values to suit program requirements. These units are indicated by heavy black line. Unit, framed in dotted lines (if used) represents equipment for diplex transmission of sound and picture. If diplexing is not used, a separate sound transmitter may be employed as in black-and-white. At right: Block diagram of color receiver. Additional items as compared to black-and-white are the color selecting means at the cathode ray tube, at present a color disc with driving motor and a motor control unit which synchronizes the color selecting means at the receiver with that at the transmitter.

stead of three as used in RCA's recently demonstrated simultaneous system. Tube could also be used in the sequential system, although light would be only 1-3 that of the simultaneous system.

High intensity cathode ray tube for present day black-and-white standards which will give up to approximately 200 foot lamberts light output, was also demonstrated. Brilliance is about 15 times that of tubes now in use and screen can be clearly seen even under floodlights.

## patents

### Motion Picture Synchronizer

Joseph D. Shantz, Fort Wayne Ind., won Pat. No. 2,412,098 on a

color scanning system designed to handle the standard rate of transmission of motion picture film (application for patent July 1, 1944; 13 claims allowed, assigned to Farnsworth Television & Radio Corporation).

The Shantz patent contains a clear review of the difficulties involved in coordinating the standard television transmission field frequency of 60 per second, twice interlaced to provide a frame frequency of 30 per second, with the present motion picture standard of 24 pictures per second. If kodachrome or technicolor films are to be televised, some efficient way must be found to synchronize the rotating light filter disk of the transmitter with the film.

This patent is based upon the now-familiar scheme of scanning successive pairs of picture frames five times while the picture transmission rate is 24 per second. Thus the field scanning period follows the standard 60 cycles per second and the picture transmission rate corresponds to its accepted standard of 24 pictures per second. Usually in this system, the first picture frame is scanned three times and the succeeding frame is scanned twice. Trouble is that this system doesn't tie in with the standard rotating disk of either three or six color filters.

The Shantz patent covers a five-color filter disk (red, green, blue, and two intermediate colors) and a method of interposing this disk in

# CBS Dual Band Receivers

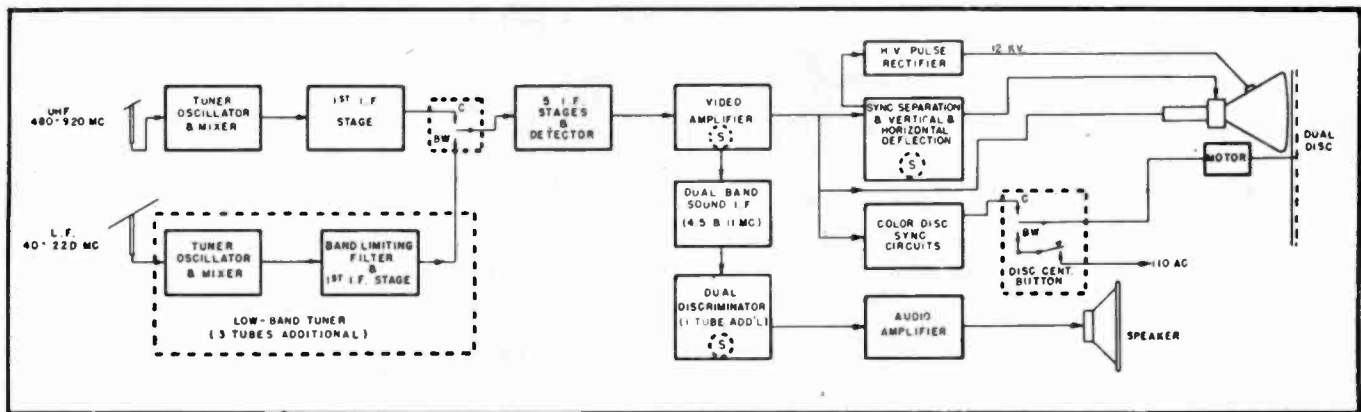
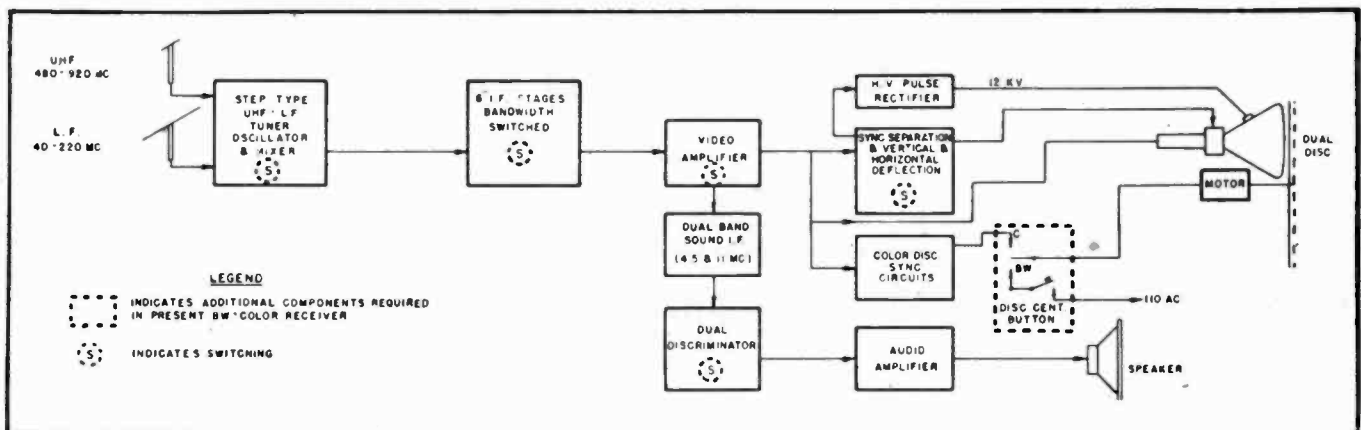

Diagram above shows the dual band receiver in its present form with the addition of suitable switches and a small low frequency tuner having three tubes. Units marked "S" inside dotted circle contain switches, ganged so that a single control selects the various operating conditions. When receiver is switched to black-and-white and the color discs stops, two sections of the disc shift slightly with respect to each other, leaving a large enough opening for viewing the black-and-white image without filters. Below: Block diagram shows dual-band receiver proposed by CBS which according to Dr. Goldmark's design requires no more tubes than the standard UHF color receivers. This is accomplished by a tuner designed to cover both UHF and the low frequency bands. Construction has not yet begun on this receiver.



synchronized rotation between the film—or other optical image to be transmitted—and the television transmitter tube. A similar disk synchronized with the disk of the transmitter is arranged in front of the receiving tube between the tube and the observer. The scanning system covered by the patent can be used for direct pickup as well as for movie transmission.

## Light Control

A more efficient mechanism for controlling light intensities in production of large television images is covered in No. 2,412,520, granted to David B. Langmuir, Englewood, and John S. Donal, Jr., Princeton Township, Mercer County, N. J.; application for patent Aug. 26, 1943; 7 claims allowed, assigned to

Radio Corporation of America.

This patent represents an effort to improve the kinescope systems where a separate source of light is utilized so that the cathode ray beam can be used merely to control the light from the constant source of high intensity.

The valve system covered by this patent includes two electron gun structures for producing separate and independent cathode ray beams. This circuit provides a highly efficient method of making the electrostatic field persist as long as possible in order to obtain high optical efficiency.

## Stereo Television

One more stab at stereo television is covered by No. 2,410,725,

granted to Alan Philip Franklin, Lower Kingswood, England, on a viewer device designed to give three-dimensional effects with a minimum of trouble. Application for the patent was made in August, 1944; five claims were allowed.

## Automatic Gain Control

Not related solely to television, but of general interest to electronics engineers, is No. 2,412,423, granted December 10 to Jan A. Rajchman and Edwin A. Goldberg, Princeton, N. J., (assignors to RCA) on an automatic gain control designed to handle multipliers of all types. The patent goes into considerable detail on means for controlling the gain of an electron multiplier.

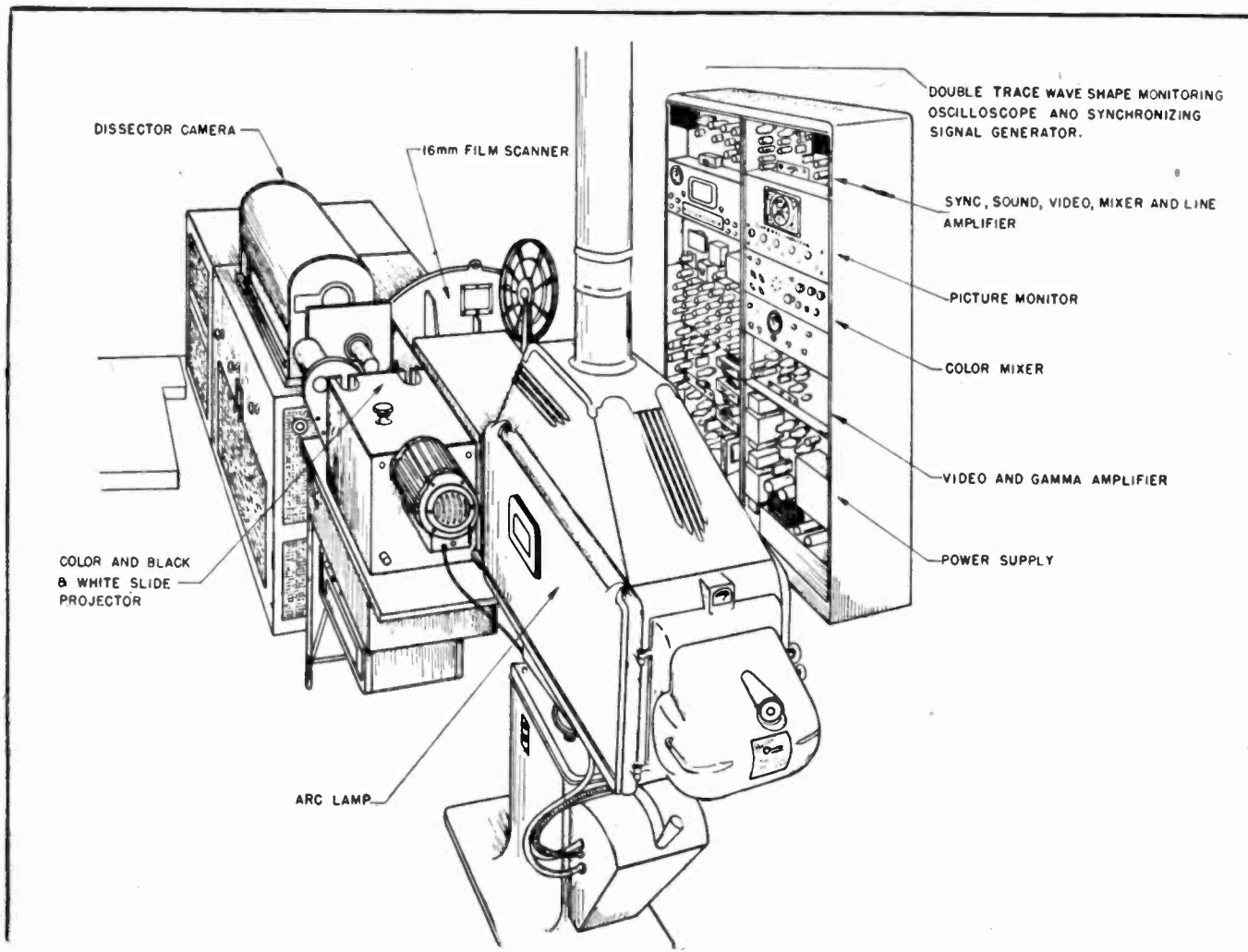

## CBS Film Channel Studio Equipment

The color film and slide transmission equipment sketched above is designed both as a unit to serve broadcast stations and to be utilized as test gear by receiver manufacturers. The standard color television composite signal from this equipment can be used to modulate either a color television broadcast or a production test transmitter. Equipment was manufactured by Westinghouse, utilizing CBS designs.

## Programming Schedule of Operating Stations (continued from page 32)

	*Cavalcade of Sports WRGB	8:30-	Ice Hockey — Pan Pacific Auditorium W6XYZ	8:30-	Hockey — ABC — Henry Lytton & Son WBKB
9:30-11:00	Wrestling from Jamaica Arena WABD	8:45-	Basketball — from Madison Square Garden — Ford WCBS-TV	8:30- 8:45	Bristol-Myers Shorty — Syd Hoff WCBS-TV
10:00-	Feature Bout *Feature Bout WRGB	<b>Sunday</b> P.M.		8:30- 8:40	Musical (film) WNBT
	*Feature Bout WPTZ	2:00-	Professional Football Playoff from Polo Grounds WNBT		*Musical (film) WRGB
<b>Saturday</b> P.M.		8:00- 8:15	*Professional Football Playoff WPTZ	8:30- 9:00	Hits and Bits — Richard Lane (variety) W6XYZ
12:00- 2:30	Wanamaker's Children's Christmas Show WABD		Standard Brands' "Face to Face" — Bob and Eddie Dunn (studio cartoon quiz) WNBT	8:40- 9:10	Let's Celebrate — Borden Company (participation) WNBT
12:00- 3:00	Special Program — RCA Victor Television Dealers (studio, film, remote) WBKB	8:00- 8:10	*Face to Face WRGB		*Let's Celebrate WRGB
7:30- 8:00	King's Party Line (participation) WCBS-TV		*Face to Face WPTZ	8:45-	Sports Almanac — Bob Edge WCBS-TV
8:00- 8:15	Saturday Revue — Jill Townsend (variety and fashion show) WCBS-TV	8:10- 8:20	The Telefunnies (favorite comic strips) W6XYZ	9:00-	Basketball — Pan Pacific Auditorium W6XYZ
8:00-	Atlantic Refining Company Sports — Basketball from U of Palestra WPTZ	8:15- 8:30	Paramount News (film slides) W6XYZ	9:10-	NBC Television Screen Magazine WNBT
8:15- 8:20	CBS Television News WCBS-TV		News — Tom O'Connor WCBS-TV		*NBC Television Screen Magazine WRGB
8:20- 8:45	"Variety Showcase" WCBS-TV	8:20- 8:30	Bristol-Myers' Tele-Varieties WNBT		*NBC Television Screen Magazine WPTZ
			*Tele-Varieties WPTZ		
			*Tele-Varieties WRGB		
			Christmas Shopping at Home W6XYZ		

\*Relayed from WNBT

## Setting Up A Film Department (continued from page 17)

job with its own facilities and staff, will require a film editing and, if positive prints are to be made, a negative timing section. This section will of course have to meet the desired standards of cleanliness and safety. Its basic equipment will include rewind tables, rewinds, extension editing flanges, numbered or lettered racks or compartments for film cuts, film splicing machines, editing machines (Movieolas, etc.), footage counters, metal furniture, safety cans for scrap films, etc. If negative is to be used for television projection, consideration should be given to the development of a video editor (electronic reversal) which will permit the film editor to view a positive on a conveniently located video screen.

### Personnel

The qualifications of personnel for this section should be carefully screened, as the technique of film editing is a highly specialized art. Person undertaking the task should be equipped with a strong dramatic sense that will permit him to select, through what will amount to creative ability, the proper angle and length of scene that will ultimately present the strongest and most effective interpretation of the film material to be televised.

Negative timing, the selection of the correct intensity of printing light to compensate for the difference in density between different scenes of an edited negative, also demands more than run of the mill skill, and personnel engaged for this function should possess the necessary qualifications. Basic equipment for this section, an inspection type rewind table, four editing type rewinds, one synchronizer type footage counter, two film splicers, one movieola type film editor, and metal accessories would cost approximately \$1,400.

### Positive Printing Section

The television station that contemplates complete motion picture production from special events to commercial motion pictures will undoubtedly need a positive printing section. This will have to be constructed along the same lines as the processing section and will, of course, have at least one printer equipped with an automatic light change device. Basic equipment for this section will cost approximately \$1,600. If the video station produces only special events and uses nega-

tive for projection, this section may be entirely eliminated, along with the facilities needed for timing negatives.

Adequate vault space must be provided for the storage of film in the various stages of production, the station's film library, leased commercial productions, the storage of raw stock and other inflammable materials such as film cement, etc. Film vaults should be constructed to provide the ultimate protection and to meet all safety regulations. Safety cans filled with water should be in each vault in order to provide a safe storage space for small film scraps until such time as they can be destroyed.

### Art Section

Another optional section is the art section. If the station is to produce commercials a complete art and title section will be necessary. Basic equipment would include a camera bed and title stand, drives and mechanisms for producing crawls and effects, lights for the title stand, a camera permitting a single frame exposure for the shooting of animations, dissolve and fade mechanisms, masks, etc. If the art work is to be of the hand created type, space and equipment must also be provided. If the titles are to be printed then type, cases and a press will be necessary. In all probability the television station will be equipped with an art department to produce still title and credit cards for its live productions.

### Summing It Up

The above facts have been presented in order to picture for the reader just a few of the many techniques and equipments that will have to be considered in the planning of such a department. In my opinion, three types of Film Production Departments can and will be activated:

The 100 per cent station operated department that will handle the entire film production job from loading the camera to providing a print or negative for projection;

The Camera Department that will handle photography and editing only, with the processing phase being handled on a contract basis by an outside laboratory;

The Supervisory Department that will handle only direction and supervision of editing, with the actual production being handled on a contract basis by a commercial motion

picture producer.

Many factors will control the amount of film production any television station may be required to enter into. In a location where facilities and terrain permits, many special events coverages can be handled "live" with video cameras and relay transmitters as well as "land lines." However, the same coverage in a different location may have to be handled on film due to structural or terrain barriers to relay transmissions or lack of line facilities. Difficult as it may be, before a television station sets up a film production department of any type, an attempt should be made to anticipate the possible percentage of future programming that will be provided by live shows and pickups, network facilities and product of outside producer-distributors of television-film productions. If it appears that such facilities and sources will provide a major percentage of a station's programs, then good business sense will dictate the organization of a film department tailored to meet the station's minimized needs.

---

## One Man's Reflections

(continued from page 20)

basket for misfits rejected by other fields. Given the nucleus of one or two real competent men, the employer can then—but only then—add a considerable number of relatively inexperienced, but interested and reasonably intelligent people. His group leaders should then be entrusted with the task of training these men in their future tasks, first on dummy and test programs and then on actual equipment as it is delivered to the station and real program. The point is that a practical compromise involves providing a few top-notch men with intelligent and willing assistants and thus lead to the upbuilding of a thoroughly competent and dependable group. One does not have to have nothing but the most costly men of greatest ability. But one does have to hire some men of this caliber. In this fashion alone can one prevent failures in whatever branch of television one may be engaged.



## EDITORIAL

**W**HEN radio first broadcast baseball games, there was considerable cautiousness on the part of the baseball magnates as to the possible effect on attendance. There is no longer any need for cautiousness or doubt. The best proof is the scramble for baseball teams to line up with the best radio stations.

Television will undoubtedly prove to be the largest attendance builder that sports have ever known. Television will introduce major sporting events to thousands and thousands of people who have never been interested before. It is true the newspapers carry stories about record-breaking attendance of 70,000 at the Yankee Stadium and 18,000 for a top bout at Madison Square Garden. But are these figures really large in view of metropolitan New York's ten million population? People who will see baseball for their first time will naturally want to see at least one game a year in the "flesh." And that one game a year attendance would fill the ball parks to capacity for every session. Perhaps the best indication of the realization of this reasoning is the fact that all three major New York teams—the Giants, the Yankees and Dodgers—have signed up for television.

And while we are on sports, let us not go overboard on its being the most popular feature that television has to offer. There will still be many millions who will not have the slightest interest in watching boxing fights every Friday night, or baseball or hockey or any other big league sport. Too many are offering statistics to show that televising of sporting events is television's number one attraction. That's easy to say now when there is very little that can compete with these major sporting events on a professional basis. Some television productions now are entertaining, but few can be classified as top professional entertainment fare. It will be interesting to see how well the Friday night boxing bouts will pull, if Jack Benny or the Theatre Guild were on a competing station at the same time.

Obviously sporting events will play an important part in television programming, particularly at the present stage when facilities for live programming are limited. But the eventual top rating television shows, with the exception of outstanding sporting events and championships, will be comedy, drama and variety similar to the entertainment the public has voted for in radio and the motion pictures. Let's not kid ourselves by all the attacks against the motion picture and radio industries' mediocre output. Both these industries are in business to make money. They can make money solely by giving the public what it wants, and we still like to say that it is acting more in the public interest to give the public what they want rather than what a few think they should have.

*“ . . . A Real contribution  
to the industry . . . ”*



*“Since its inception I have been grateful for the objective and complete reporting job done by TELEVISION magazine in these development days of television.*

*“In my view this magazine is making a very real contribution to the industry by digging out the facts and printing them in an understandable and concise form.”*

*William E. Forbes*

*Manager, Television Dept.  
Young & Rubicam, Inc.*

*William E. Forbes, manager of television, Young & Rubicam, Inc.*

More and more advertisers and broadcasters like Bill Forbes of Young & Rubicam are depending on TELEVISION magazine for the factual information which will help them in their television plans and work.

Each month TELEVISION is read by 4,000 key executives in broadcasting, advertising, manufacturing, film production, publishing, department stores, and other closely allied fields.

Whether you are selling equipment, station time, programs, film—in fact whatever you are selling in television you'll find TELEVISION magazine, the industry's only monthly publication, the most effective medium to reach the men who buy.

TELEVISION magazine, 600 Madison Avenue, New York 22.

And  
now  
it's...

*Congratulations,  
Cleveland*



## ... on your new TELEVISION Station

**S**CRIPPS-HOWARD — a name long celebrated in newspaper and radio worlds—moves into a new medium by staking a first claim in the promising field of Television. Cleveland will be given television broadcasting service early in the summer of 1947.

It is significant that these wisely operated newspaper and radio interests have chosen Du Mont television equipment. The contract for the complete installation has been awarded by Scripps-Howard Radio, Inc., to Allen B. Du Mont Laboratories, Inc., pioneering pace-maker of the television industry and builder of more television broadcasting stations than

any other equipment manufacturer.

Du Mont will provide and install a 5 kw video transmitter, 2.5 kw audio transmitter, a three-camera studio chain, dual film pickup chain, a three-camera Image Orthicon field pickup chain, master control board, antenna, and complete audio, lighting and testing equipment.

Du Mont's fifteen years of precision electronic "know how" assure tested, dependable designs. May we show you Du Mont equipment in use in the world's largest and most completely equipped television studios — at Station WABD, New York?

IF YOU HAVE NOT READ "THE ECONOMICS OF DU MONT TELEVISION," MAY WE SEND YOU A COPY? ASK FOR IT TODAY.

**DU MONT**

*First with the Finest in Television*

Copyright 1946, Allen B. Du Mont Laboratories, Inc.

ALLEN B. DU MONT LABORATORIES, INC. • GENERAL TELEVISION SALES OFFICES & STATION WABD, 515 MADISON AVENUE, NEW YORK 22, N. Y.  
DU MONT'S JOHN WANAMAKER TELEVISION STUDIOS, WANAMAKER PLACE, NEW YORK 3, N. Y. • HOME OFFICES & PLANTS, PASSAIC, N. J.